



Extending Energy Efficiency From Silicon To The Platform And Beyond

Raj Hazra

Director, Systems Technology Lab

Intel Developer
FORUM

Agenda

- **Defining Terms**
- **Why Platform Energy Efficiency**
- **Value**
- **Intel Research**
- **Call to Action**

Defining Terms



Efficient Power Delivery

Optimizing delivery of power to the platform and through to silicon



Improved Power Management

Better managing how and when power is used

Why Platform Efficiency

- As perf/watt of silicon improves, efficient operation across the rest of the platform becomes increasingly important
- Mobile example
 - Data Center Example

Laptop Power Utilization

Typical Office Application

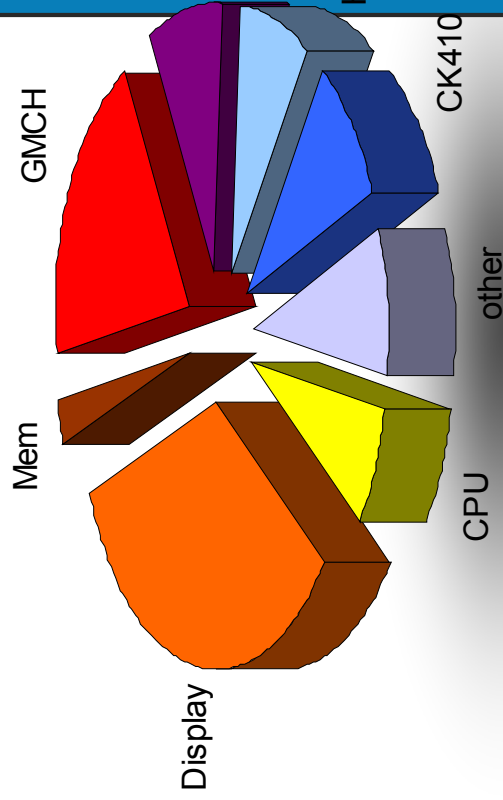

Data Center Power Distribution

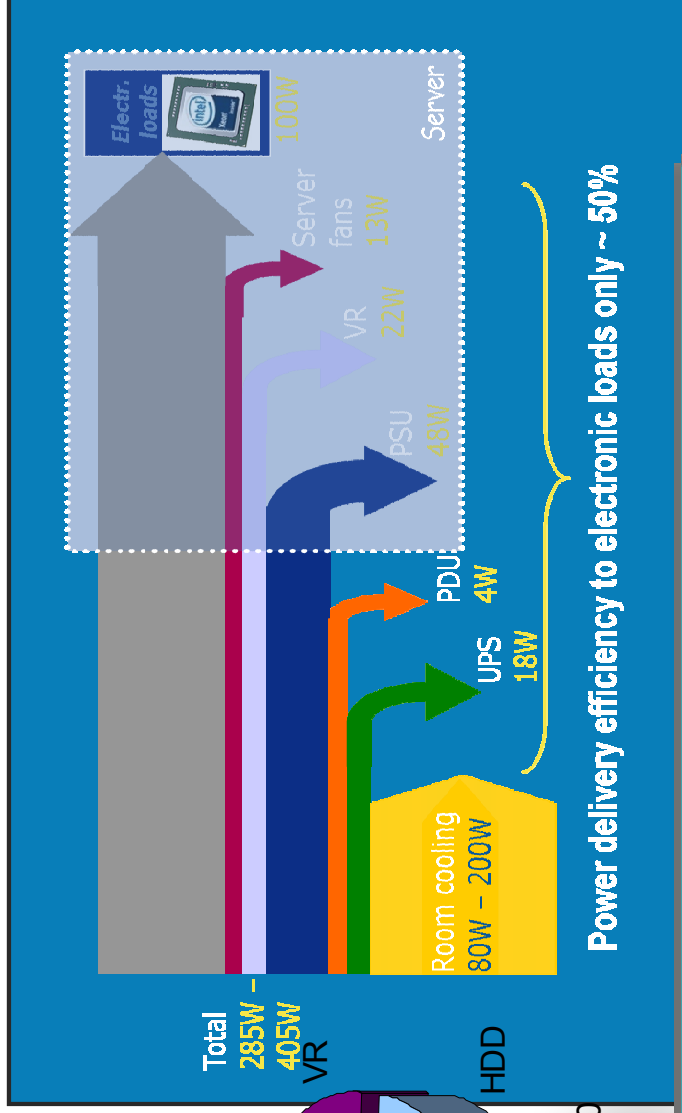

Future leaps in energy efficiency will come from combined improvements in silicon *and* the platform

Value of Improved Platform Efficiency

Mobile

- Smaller
- Cooler
- Easier to design
- Lower cost



Increased Battery Life

Server & Desktop

- Quieter
- Cooler
- Lower utility costs
- Better reliability

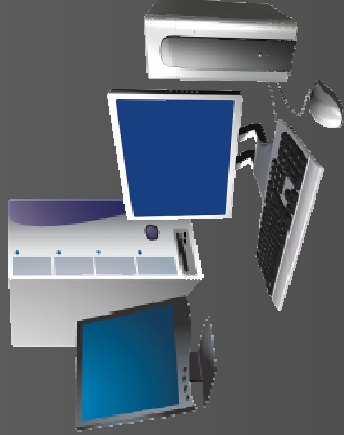

Lower TCO

Data Center

- Less cooling
- Lower utility costs
- Better reliability
- Simplified power mgmt



Greater Density

Value Beyond Improved Devices

Environment

- Reduced global carbon footprint for compute devices
- Fewer number of power plants to support expected growth



Regulatory

- Better compliance with emerging regulatory pressures
- Improved flexibility when planning data centers



Emerging Markets

- Lessens demand on grid
- Minimizes utility costs in power limited geographies



How is Intel Improving Platform Efficiency?

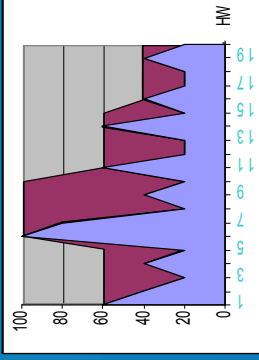

Redefining Power Management

- Moving beyond ACPI
- SW Directed, HW Managed
- Fine Grained Power Management

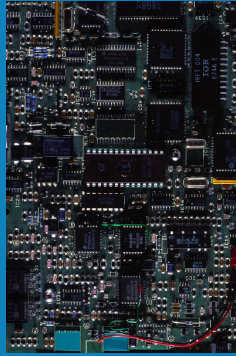

Innovations in Power Delivery

- Integrated Voltage Regulators
- Load Adaptive
- Fewer Voltage Rails

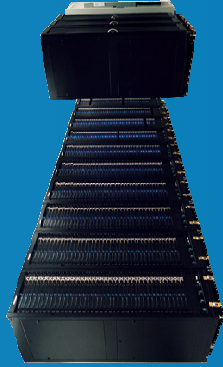

Extending to the Data Center

- Power management across groups of platforms
- Optimizing power delivery within the data center

Innovative Power Management

- Shift from OS to HW based power management
- Research underway in multiple areas

1. Today's idle behavior
2. New idle behavior
3. Key press
4. Re-enters idle

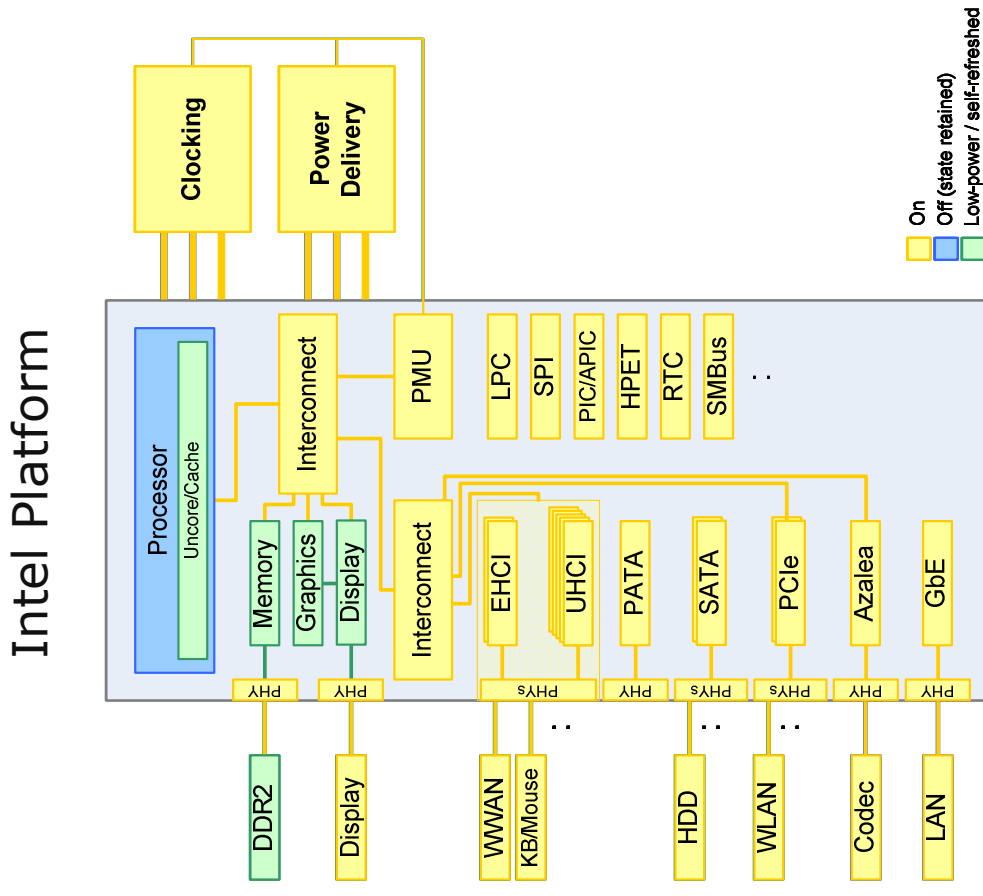

Efficient Power Delivery

- Several challenges in existing platform power delivery
- Intel researching multiple improvements

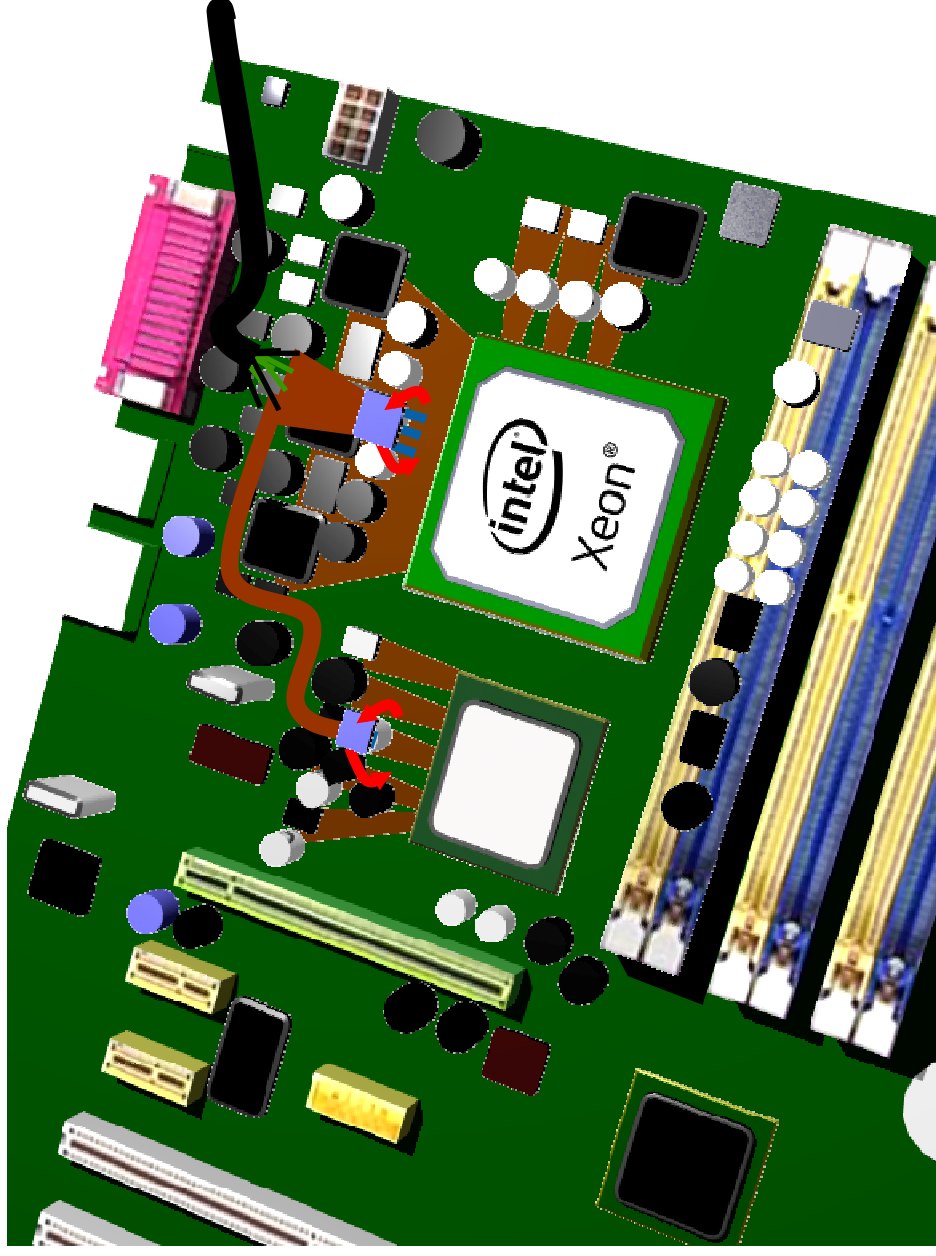

30% improvement in power delivery efficiency

Innovations in the Data Center

- Better efficiency through improved group management
- Optimizing data center power delivery

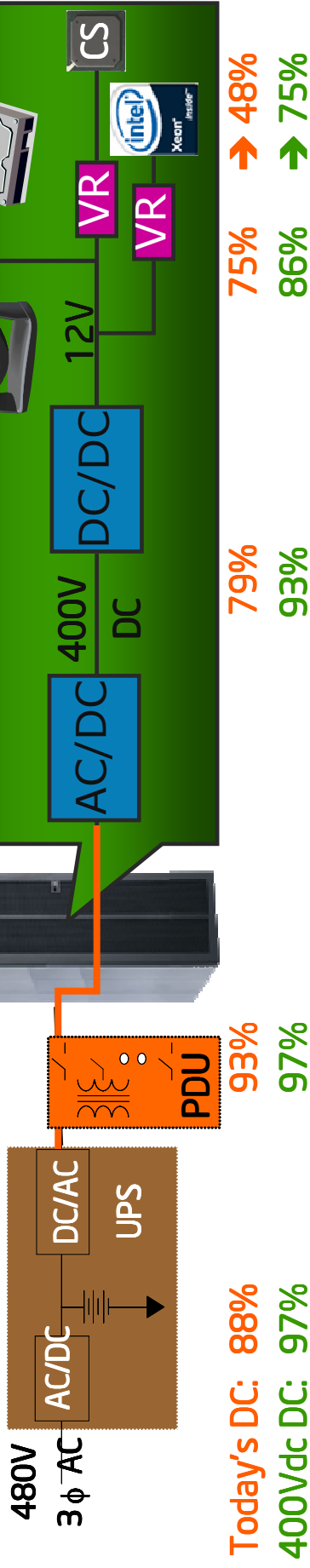
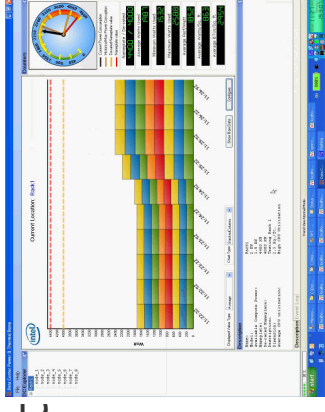

> 25% improvement in data center efficiency

Energy Efficiency – Regulatory View

Focus: Energy Efficient Performance

- Preserving Performance
- While Reducing Energy Impact By 2010
 - Save \$5.5B Collectively in Energy Costs
- Reduce Global CO₂ emissions by 54 Million Tons / Year
 - Without Derailing Moore's Law

Most Performance w/ Least Energy

Harmonizing Energy Efficiency Standards WW

- One Planet, many Regulators
- Working towards Harmonized Standards among all
- Not just Energy, but ROHS, Materials, Packaging



Energy Leads in Holistic Green Strategy

Ecosystem & Industry Partners

- Chips, Boards, Systems, Software, Data Centers, Manufacturers, OEMs
- 4 Year Roadmap of Improved PSU & Motherboard efficiency





We're all in this together

Investing in Start-ups focused on Energy Efficiency

Mobile & Consumer

- Voltage Regulation
 - 
- Displays
 - 
 - 
- Low-power wireless
 - 
 - 
 - 

Server & Desktop

- Virtualization
 - 
- Voltage Regulation
 - 
- Better airflow, lower data error rates
 - 

Note: example only, not an exhaustive list

Call to Action

Advances require industry coordination

	Intel	Industry	Regulatory
Improve Si & Platform	Yes	Yes	
Evolve System Software	Yes	Yes	
Coordinate with Regulatory	Yes	Yes	Yes
Advance 400V DC in data center	Yes	Yes	Yes



Risk Factors

Today's presentation contains forward-looking statements. All statements made that are not historical facts are subject to a number of risks and uncertainties, and actual results may differ materially. Please refer to our most recent Earnings Release and our most recent Form 10-Q or 10-K filing available on our website for more information on the risk factors that could cause actual results to differ.

Legal Disclaimer

- INFORMATION IN THIS DOCUMENT IS PROVIDED IN CONNECTION WITH INTEL® PRODUCTS. NO LICENSE, EXPRESS OR IMPLIED, BY ESTOPPEL OR OTHERWISE, TO ANY INTELLECTUAL PROPERTY RIGHTS IS GRANTED BY THIS DOCUMENT. EXCEPT AS PROVIDED IN INTEL'S TERMS AND CONDITIONS OF SALE FOR SUCH PRODUCTS, INTEL ASSUMES NO LIABILITY WHATSOEVER, AND INTEL DISCLAIMS ANY EXPRESS OR IMPLIED WARRANTY, RELATING TO SALE AND/OR USE OF INTEL® PRODUCTS INCLUDING LIABILITY OR WARRANTIES RELATING TO FITNESS FOR A PARTICULAR PURPOSE, MERCHANTABILITY, OR INFRINGEMENT OF ANY PATENT, COPYRIGHT OR OTHER INTELLECTUAL PROPERTY RIGHT. INTEL PRODUCTS ARE NOT INTENDED FOR USE IN MEDICAL, LIFE SAVING, OR LIFE SUSTAINING APPLICATIONS.
- Intel may make changes to specifications and product descriptions at any time, without notice.
- All products, dates, and figures specified are preliminary based on current expectations, and are subject to change without notice.
- Intel, processors, chipsets, and desktop boards may contain design defects or errors known as errata, which may cause the product to deviate from published specifications. Current characterized errata are available on request.
- Performance tests and ratings are measured using specific computer systems and/or components and reflect the approximate performance of Intel products as measured by those tests. Any difference in system hardware or software design or configuration may affect actual performance.
- Intel, Intel Inside, Intel Xeon, and the Intel logo are trademarks of Intel Corporation in the United States and other countries.
- *Other names and brands may be claimed as the property of others.
- Copyright © 2007 Intel Corporation.