

Intel® Desktop Board D865GSA Product Guide

Order Number: D52861-001

Revision History

Revision	Revision History	Date
-001	First release of the Intel® Desktop Board D865GSA Product Guide	March 2006

If an FCC declaration of conformity marking is present on the board, the following statement applies:

FCC Declaration of Conformity

This device complies with Part 15 of the FCC Rules. Operation is subject to the following two conditions: (1) this device may not cause harmful interference, and (2) this device must accept any interference received, including interference that may cause undesired operation.

For questions related to the EMC performance of this product, contact:

Intel Corporation
5200 N.E. Elam Young Parkway
Hillsboro, OR 97124
1-800-628-8686

This equipment has been tested and found to comply with the limits for a Class B digital device, pursuant to Part 15 of the FCC Rules. These limits are designed to provide reasonable protection against harmful interference in a residential installation. This equipment generates, uses, and can radiate radio frequency energy and, if not installed and used in accordance with the instructions, may cause harmful interference to radio communications. However, there is no guarantee that interference will not occur in a particular installation. If this equipment does cause harmful interference to radio or television reception, which can be determined by turning the equipment off and on, the user is encouraged to try to correct the interference by one or more of the following measures:

- Reorient or relocate the receiving antenna.
- Increase the separation between the equipment and the receiver.
- Connect the equipment to an outlet on a circuit other than the one to which the receiver is connected.
- Consult the dealer or an experienced radio/TV technician for help.

Any changes or modifications to the equipment not expressly approved by Intel Corporation could void the user's authority to operate the equipment.

Tested to comply with FCC standards for home or office use.

Canadian Department of Communications Compliance Statement

This digital apparatus does not exceed the Class B limits for radio noise emissions from digital apparatus set out in the Radio Interference Regulations of the Canadian Department of Communications.

Le présent appareil numérique n'émet pas de bruits radioélectriques dépassant les limites applicables aux appareils numériques de la classe B prescrites dans le Règlement sur le brouillage radioélectrique édicté par le ministère des Communications du Canada.

Disclaimer

Information in this document is provided in connection with Intel® products. No license, express or implied, by estoppel or otherwise, to any intellectual property rights is granted by this document. Except as provided in Intel's Terms and Conditions of Sale for such products, Intel assumes no liability whatsoever, and Intel disclaims any express or implied warranty, relating to sale and/or use of Intel products including liability or warranties relating to fitness for a particular purpose, merchantability, or infringement of any patent, copyright or other intellectual property right. Intel products are not intended for use in medical, life saving, or life sustaining applications. Intel may make changes to specifications and product descriptions at any time, without notice.

Desktop Board D865GSA may contain design defects or errors known as errata which may cause the product to deviate from published specifications. Current characterized errata are available on request.

Contact your local Intel sales office or your distributor to obtain the latest specifications and before placing your product order.

Copies of documents which have an ordering number and are referenced in this document, or other Intel literature, may be obtained from Intel Corporation by going to the World Wide Web site at: <http://www.intel.com/> or by calling 1-800-548-4725.

Intel, Pentium, and Celeron are registered trademarks of Intel Corporation or its subsidiaries in the United States and other countries.

* Other names and brands may be claimed as the property of others.

Copyright © 2006, Intel Corporation. All rights reserved.

Preface

This Product Guide gives information about board layout, component installation, and regulatory requirements for Intel® Desktop Board D865GSA.

Intended Audience

The Product Guide is intended for technically qualified personnel. It is not intended for general audiences.

Use Only for Intended Applications

All Intel desktop boards are evaluated as Information Technology Equipment (I.T.E.) for use in personal computers (PC) for installation in homes, offices, schools, computer rooms, and similar locations. The suitability of this product for other PC or embedded non-PC applications or other environments, such as medical, industrial, alarm systems, test equipment, etc. may not be supported without further evaluation by Intel.

Document Organization

The chapters in this Product Guide are arranged as follows:

- 1 Desktop Board Features: a summary of product features
- 2 Installing and Replacing Desktop Board Components: instructions on how to install the desktop board and other hardware components
- 3 Updating the BIOS: instructions on how to update the BIOS
- A Error Messages and Indicators: information about BIOS error messages and beep codes
- B Regulatory Compliance: safety and EMC certifications, product certification

Terminology

The table below gives descriptions to some common terms used in the product guide.

Term	Description
GB	Gigabyte (1,073,741,824 bytes)
GHz	Gigahertz (one billion hertz)
KB	Kilobyte (1024 bytes)
MB	Megabyte (1,048,576 bytes)
Mbit	Megabit (1,048,576 bits)
MHz	Megahertz (one million hertz)

Box Contents

- Intel Desktop Board D865GSA
- I/O shield
- One ATA-66/100 cable
- Two locking Serial ATA cables
- Quick Reference poster
- Configuration and battery caution statement label
- Intel® Express Installer driver CD-ROM

Contents

1 Desktop Board Features

Supported Operating Systems	10
Desktop Board Components	11
Processor	13
Main Memory	14
Intel® 865G Chipset	15
Graphics Subsystem	15
Audio Subsystem	15
Input/Output (I/O) Controller.....	15
LAN Subsystem	16
LAN Subsystem Software	16
RJ-45 LAN Connector LEDs	16
Hi-Speed USB 2.0 Support	17
Enhanced IDE Interface	17
Serial ATA.....	17
Expandability.....	17
BIOS.....	18
Serial ATA and IDE Auto Configuration	18
PCI Auto Configuration	18
Security Passwords.....	18
Chassis Intrusion.....	18
Power Management Features.....	19
ACPI.....	19
Power Connectors.....	19
Fan Connectors.....	19
Suspend to RAM (Instantly Available PC Technology)	20
Wake from USB	21
Wake from PS/2 Keyboard/Mouse.....	21
PME# Wakeup Support.....	21
Speaker.....	21
Battery.....	21
Real-Time Clock.....	21

2 Installing and Replacing Desktop Board Components

Before You Begin	23
Installation Precautions	24
Prevent Power Supply Overload	24
Observe Safety and Regulatory Requirements.....	24
Installing the I/O Shield	25
Installing and Removing the Desktop Board	26
Installing and Removing a Processor.....	27
Installing a Processor.....	27
Installing the Processor Fan Heat Sink	30
Connecting the Processor Fan Heat Sink Cable.....	30
Removing the Processor.....	30

Installing and Removing Memory	31
Installing DIMMs.....	33
Removing DIMMs.....	34
Installing and Removing an AGP Card	34
Installing an AGP Card.....	34
Removing an AGP Card.....	36
Connecting the IDE Cables.....	37
Connecting the Serial ATA (SATA) Cable.....	38
Connecting Internal Headers	39
Installing a Front Panel Audio Solution	40
Connecting to the CD-ROM Audio Header	40
Connecting to the USB 2.0 Header.....	41
Connecting to the Front Panel Header.....	41
Connecting Chassis Fan and Power Cables.....	42
Connecting Chassis Fan Cables.....	42
Connecting Power Cables.....	43
Other Connectors.....	44
Setting the BIOS Configuration Jumper	45
Clearing Passwords	46
Back Panel Connectors.....	47

3 Updating the BIOS

Updating the BIOS with the Intel® Express BIOS Update Utility	53
Updating the BIOS with the Iflash Memory Update Utility.....	53
Obtaining the BIOS Update File.....	53
Updating the BIOS	54
Recovering the BIOS	54

A Error Messages and Indicators

BIOS Beep Codes.....	55
BIOS Error Messages	55

B Regulatory Compliance

Safety Regulations	57
Place Battery Marking	57
European Union Declaration of Conformity Statement	58
Product Ecology Statements.....	59
Lead-Free Desktop Board.....	61
EMC Regulations	62
Ensure Electromagnetic Compatibility (EMC) Compliance	63
Product Certifications	63
Board-Level Certification Markings	63
Chassis and Component Certifications	64

Figures

1. Desktop Board D865GSA Components	11
2. LAN Connector LEDs	16
3. Location of Standby Power Indicator	20
4. Installing the I/O Shield.....	25
5. Desktop Board D865GSA Mounting Screw Hole Locations	26
6. Lift the Socket Lever.....	27
7. Lift the Load Plate.....	27
8. Remove the Protective Socket Cover.....	28
9. Remove the Processor from the Protective Processor Cover	28
10. Install the Processor.....	29
11. Close the Load Plate	29
12. Connecting the Processor Fan Heat Sink Cable to the Processor Fan Header.....	30
13. Dual Channel Memory Configuration Example	31
14. Use DDR DIMMs	32
15. Installing a DIMM.....	33
16. Installing an AGP Card	35
17. Removing an AGP Card	36
18. Connecting the IDE Cable	37
19. Connecting the Serial ATA Cable.....	38
20. Internal Headers.....	39
21. Location of Chassis Fan Headers	42
22. Connecting Power Supply Cables	43
23. Location of Other Connectors.....	44
24. Location of the BIOS Configuration Jumper Block	45
25. Back Panel Connectors.....	47
26. Removing the Battery	52

Tables

1. Feature Summary.....	9
2. Desktop Board D865GSA Components	12
3. Power Supply Requirements.....	13
4. Desktop Board D865GSA Memory Speeds	14
5. LAN Connector LEDs	16
6. Audio Header Signal Names	40
7. CD-ROM Audio Header Signal Names	40
8. USB 2.0 Header Signal Names	41
9. Front Panel Header Signal Names.....	41
10. Jumper Settings for the BIOS Setup Program Modes.....	46
11. Beep Codes.....	55
12. BIOS Error Messages.....	55
13. Safety Regulations	57
14. Lead-Free Board Markings.....	61
15. EMC Regulations.....	62
16. Product Certification Markings.....	63

1 Desktop Board Features

This chapter briefly describes the features of Intel® Desktop Board D865GSA. Table 1 summarizes the major features of the desktop board.

Table 1. Feature Summary

Form Factor	microATX (243.84 millimeters [9.60 inches] x 223.52 millimeters [8.80 inches])
Processor	Support for an Intel® processor in the LGA775 package
Main Memory	<ul style="list-style-type: none"> • Two 184-pin, 2.5 V DDR SDRAM Dual Inline Memory Module (DIMM) sockets • Dual channel 400/333/266 MHz DDR SDRAM interface • Designed to support up to 2 GB of system memory
Chipset	Intel® 865G chipset consisting of: <ul style="list-style-type: none"> • Intel® 82865G Graphics and Memory Controller Hub (GMCH) with Accelerated Hub Architecture (AHA) bus • Intel® 82801EB I/O Controller Hub (ICH5) • 4 Mbit Firmware Hub (FWH)
Graphics	<ul style="list-style-type: none"> • Intel 865G chipset • Integrated Intel® Extreme Graphics 2 • Support for AGP 8X
Audio	<ul style="list-style-type: none"> • Intel 865G chipset (AC '97) • Realtek* ALC655 audio codec
LAN	Realtek RTL8100C Ethernet Controller (10/100 Mb/s) and RJ-45 connector
Peripheral Interfaces	<ul style="list-style-type: none"> • Up to eight USB 2.0 ports <ul style="list-style-type: none"> — Four ports routed to the back panel — Four ports routed to two internal USB headers • Two IDE interfaces with Ultra DMA-33 and ATA-66/100 support • Two Serial ATA (SATA) connectors • One diskette drive interface • One parallel port • One serial port • One VGA port • PS/2* keyboard and mouse ports
Expansion Capabilities	<ul style="list-style-type: none"> • Three PCI bus add-in card connectors • One AGP connector
BIOS	<ul style="list-style-type: none"> • Intel® BIOS
Power Management	<ul style="list-style-type: none"> • Support for Advanced Configuration and Power Interface (ACPI) • Suspend to RAM (STR) • Wake on USB, PCI, RS-232, PS/2, LAN, and front panel

continued

Table 1. Feature Summary (continued)

Hardware Management	Hardware monitor with: <ul style="list-style-type: none">• Three fan sensing inputs used to monitor fan activity• Remote diode temperature sensing• Voltage sensing to detect out of range values
----------------------------	---

Related Links:

For more information about Desktop Board D865GSA, including the Technical Product Specification (TPS), BIOS updates, and device drivers, go to:

<http://support.intel.com/support/motherboards/desktop/>

Supported Operating Systems

The desktop board supports the following operating systems:

- Microsoft Windows* XP Professional, SP2
- Microsoft Windows XP Home, SP2
- Microsoft Windows 2000, SP4

Desktop Board Components

Figure 1 shows the approximate location of the major components on Desktop Board D865GSA.

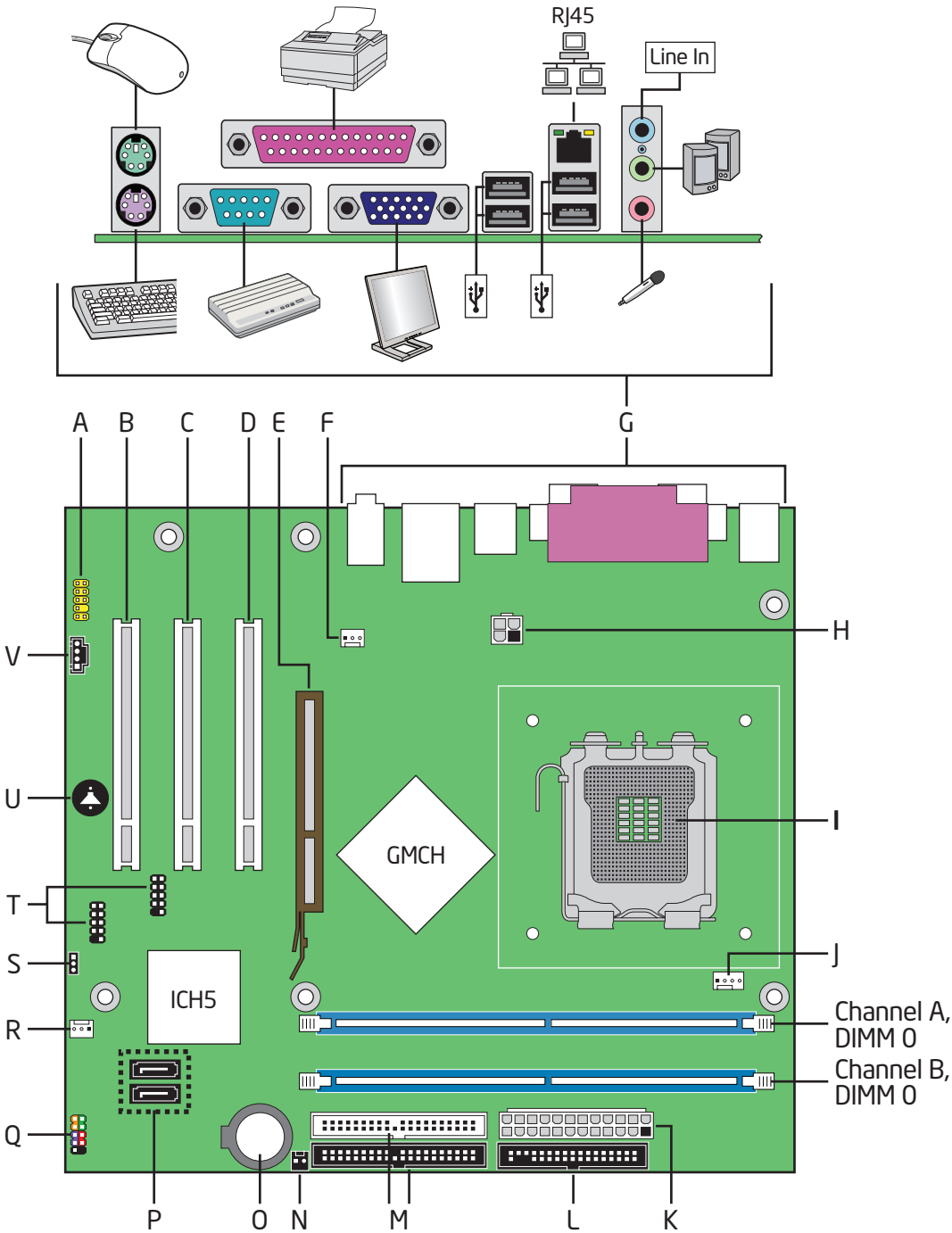

OM19170

Figure 1. Desktop Board D865GSA Components

Table 2. Desktop Board D865GSA Components

Label	Description
A	Front panel audio header
B	PCI bus connector 3
C	PCI bus connector 2
D	PCI bus connector 1
E	AGP connector
F	Rear chassis fan header (3-pin)
G	Back panel connectors
H	12 V processor core voltage connector (2 x 2 pin)
I	Processor socket
J	Processor fan header (4-pin)
K	Main power connector (2 x 12 pin)
L	Diskette drive connector
M	IDE connectors
N	Chassis intrusion header
O	Battery
P	Serial ATA connectors
Q	Front panel header
R	Front chassis fan header (3-pin)
S	BIOS configuration jumper block
T	USB 2.0 headers
U	Speaker
V	CD-ROM audio header

Related Links:

Go to the following links for more information about:

- Desktop Board D865GSA <http://www.intel.com/design/motherbd>
<http://support.intel.com/support/motherboards/desktop>
- Supported processors <http://support.intel.com/support/motherboards/desktop>
- Audio software and utilities <http://www.intel.com/design/motherbd>
- LAN software and drivers <http://www.intel.com/design/motherbd>

Processor



CAUTION

Failure to use the appropriate power supply (see Table 3) and/or not connecting the 12 V (2 x 2 pin) power connector to the desktop board may result in damage to the board, or the system may not function properly.

Table 3. Power Supply Requirements

Platform Compatibility Guide	Power Supply Requirements
05A	12V2 rating of 13 A continuous and 16.5 A peak current for 10 ms
04A	ATX12V (version 2.0 or greater) compliant power supply

Desktop Board D865GSA supports an Intel processor in the LGA775 package. Processors are not included with the desktop board and must be purchased separately. The processor connects to the desktop board through the LGA775 socket.

The supported processors list for Desktop Board D865GSA is located on the web at:

<http://support.intel.com/support/motherboards/desktop/>

Related Links:

Go to the following links or pages for more information about:

- Instructions on installing or upgrading the processor, page 27 in Chapter 2
- The location of the two power connectors, page 43 in Chapter 2

Main Memory



NOTE

To be fully compliant with all applicable Intel® SDRAM memory specifications, the board should be populated with DIMMs that support the Serial Presence Detect (SPD) data structure. If your memory modules do not support SPD, you will see a notification to this effect on the screen at power up. The BIOS will attempt to configure the memory controller for normal operation.

The desktop board supports system memory as defined below:

- Two dual channel 184-pin Double Data Rate (DDR) SDRAM Dual Inline Memory Module (DIMM) connectors with gold-plated contacts.
- Memory speeds as defined in Table 4.

Table 4. Desktop Board D865GSA Memory Speeds

Memory Speed	Front Side Bus Frequency (MHz)	Memory Speed Outcome (MHz)
DDR400	800	400
DDR333	800	320
	533	333
DDR266	533	266

- Support for:
 - Unbuffered, non-registered DIMMs
 - Serial Presence Detect (SPD) memory only
 - Suspend to RAM (STR), S3 ACPI state
 - Non-ECC DDR
 - 2.5 V memory
 - Memory configuration listed below:
 - Up to 1.0 GB utilizing 256 Mb technology
 - Up to 2.0 GB utilizing 512 Mb technology

Related Links:

Go to the following links or pages for more information about:

- The latest list of tested memory, <http://support.intel.com/support/motherboards/desktop/>
- SDRAM specifications, <http://www.intel.com/technology/memory/>
- Installing memory, page 31 in Chapter 2

Intel® 865G Chipset

The Intel 865G chipset consists of the following devices:

- Intel 82865G Graphics and Memory Controller Hub (GMCH) with AHA bus
- Intel 82801EB I/O Controller Hub (ICH5) with AHA bus
- Firmware Hub (FWH)

Related Link

For more information about the Intel 865GV chipset, go to:

<http://developer.intel.com/design/nav/pcserver.htm>

Graphics Subsystem

The graphics subsystem features the following:

- The Intel 865G chipset
- Intel Extreme Graphics 2
- Support for AGP 8X

Audio Subsystem

The audio subsystem features the following:

- Intel 865G chipset (AC '97)
- Realtek ALC655 audio codec

Related Links:

Go to the following link or pages for more information about:

- Audio drivers and utilities <http://support.intel.com/support/motherboards/desktop/>
- Installing a front panel audio solution, page 40 in Chapter 2

Input/Output (I/O) Controller

The super I/O controller features the following:

- Low pin count (LPC) interface
- One serial port
- One parallel port with Extended Capabilities Port (ECP) and Enhanced Parallel Port (EPP) support
- Serial IRQ interface compatible with serialized IRQ support for PCI systems
- PS/2-style mouse and keyboard interfaces
- Interface for one 1.2 MB or 1.44 MB diskette drive
- Intelligent power management, including a programmable wake up event interface
- PCI power management support

LAN Subsystem

The LAN subsystem provides the following functions:

- 10/100 Ethernet LAN controller (Realtek RTL8100C)
- Support for RJ-45 connector with status indicator LEDs
- Programmable transit threshold
- Configurable EEPROM that contains the MAC address

LAN Subsystem Software

For LAN software and drivers, refer to the D865GSA link on Intel's World Wide Web site at:

<http://support.intel.com/support/motherboards/desktop>

RJ-45 LAN Connector LEDs

Two LEDs are built into the RJ-45 LAN connector located on the back panel (see Figure 2).

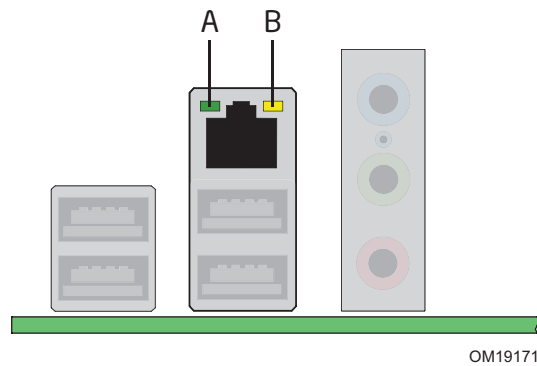

Figure 2. LAN Connector LEDs

Table 5 describes the LED states when the board is powered up and the 10/100 Ethernet LAN subsystem is operating.

Table 5. LAN Connector LEDs

LED Color	LED State	Indicates
Green (A)	Off	LAN link is not established
	On	LAN link is established
	Blinking	LAN activity is occurring
Yellow (B)	Off	10 Mb/s data rate
	On (steady state)	100 Mb/s data rate

Hi-Speed USB 2.0 Support



NOTE

Computer systems that have an unshielded cable attached to a USB port might not meet FCC Class B requirements, even if no device or a low-speed USB device is attached to the cable. Use a shielded cable that meets the requirements for a full-speed USB device.

The desktop board supports up to eight USB 2.0 ports via ICH5; four ports routed to the back panel and four routed to two internal USB 2.0 headers. USB 2.0 ports are backward compatible with USB 1.1 devices. USB 1.1 devices will function normally at USB 1.1 speeds.

USB 2.0 support requires both an operating system and drivers that fully support USB 2.0 transfer rates. Disabling Hi-Speed USB in the BIOS reverts all USB 2.0 ports to USB 1.1 operation. This may be required to accommodate operating systems that do not support USB 2.0.

Enhanced IDE Interface

The ICH5's IDE interface handles the exchange of information between the processor and peripheral devices such as hard disk drives and CD-ROM drives. The interface supports:

- Up to four IDE devices (such as hard drives)
- ATAPI-style devices (such as CD-ROM drives)
- Older PIO Mode devices
- Ultra DMA-33 and ATA-66/100 protocols

Serial ATA

The desktop board supports two Serial ATA channels via ICH5, connecting one device per channel.

Expandability

For system expansion, the desktop board provides the following:

- Three PCI connectors
- One AGP connector

BIOS

The BIOS provides the Power-On Self-Test (POST), the BIOS Setup program, the PCI and IDE auto-configuration utilities, and the video BIOS. The BIOS is stored in the Serial Peripheral Interface (SPI) Flash or the Firmware Hub.

Serial ATA and IDE Auto Configuration

If you install a Serial ATA or IDE device (such as a hard drive) in your computer, the auto-configuration utility in the BIOS automatically detects and configures the device for your computer. You do not need to run the BIOS Setup program after installing a Serial ATA or IDE device. You can override the auto-configuration options by specifying manual configuration in the BIOS Setup program.

PCI Auto Configuration

If you install a PCI add-in card in your computer, the PCI auto-configuration utility in the BIOS automatically detects and configures the resources (IRQs, DMA channels, and I/O space) for that add-in card. You do not need to run the BIOS Setup program after you install a PCI add-in card.

Security Passwords

The BIOS includes security features that restrict whether the BIOS Setup program can be accessed and who can boot the computer. A supervisor password and a user password can be set for the BIOS Setup and for booting the computer, with the following restrictions:

- The supervisor password gives unrestricted access to view and change all Setup options. If only the supervisor password is set, pressing <Enter> at the password prompt of Setup gives the user restricted access to Setup.
- If both the supervisor and user passwords are set, you must enter either the supervisor password or the user password to access Setup. Setup options are then available for viewing and changing depending on whether the supervisor or user password was entered.
- Setting a user password restricts who can boot the computer. The password prompt is displayed before the computer is booted. If only the supervisor password is set, the computer boots without asking for a password. If both passwords are set, you can enter either password to boot the computer.

Related Links:

For instructions on resetting the password, see [Clearing Passwords](#) on page 46.

Chassis Intrusion

The board supports a chassis security feature that detects if the chassis cover has been removed. The security feature uses a mechanical switch on the chassis that can be connected to the chassis intrusion header on the desktop board. See [Figure 23](#) on page 44 for the location of the chassis intrusion header.

Power Management Features

Power management is implemented at several levels, including:

- Advanced Configuration and Power Interface (ACPI)
- Hardware support:
 - Power connectors
 - Fan connectors
 - Suspend to RAM (Instantly Available PC technology)
 - Wake from USB
 - Wake from PS/2 keyboard/mouse
 - PME# wakeup support

ACPI

ACPI gives the operating system direct control over the power management and Plug and Play functions of a computer. The use of ACPI with the desktop board requires an operating system that provides full ACPI support.

Power Connectors

The desktop board has two power connectors. See Figure 22 on page 43 for the location of the power connectors.

Fan Connectors

The desktop board has a 4-pin processor fan header and two 3-pin chassis fan headers. See Figure 21 on page 42 for the location of the chassis fan headers.

Suspend to RAM (Instantly Available PC Technology)

CAUTION

For Instantly Available PC technology, the 5 V standby line for the power supply must be capable of delivering adequate +5 V standby current. Failure to provide adequate standby current when using this feature can damage the power supply and/or effect ACPI S3 sleep state functionality.

Power supplies used with this desktop board must be able to provide enough standby current to support the standard Instantly Available (ACPI S3 sleep state) configuration. If the standby current necessary to support multiple wake events from the PCI and/or USB buses exceeds power supply capacity, the desktop board may lose register settings stored in memory.

Instantly Available PC technology enables the board to enter the ACPI S3 (Suspend-to-RAM) sleep state. While in the S3 sleep state, the computer will appear to be off. When signaled by a wake-up device or event, the system quickly returns to its last known awake state.

The desktop board's standby power indicator, shown in Figure 3, is lit when there is standby power to the system. This includes the memory modules and PCI bus connectors, even when the computer appears to be off.

If the system has a dual-colored power LED on the front panel, the sleep state is indicated by the LED turning amber.

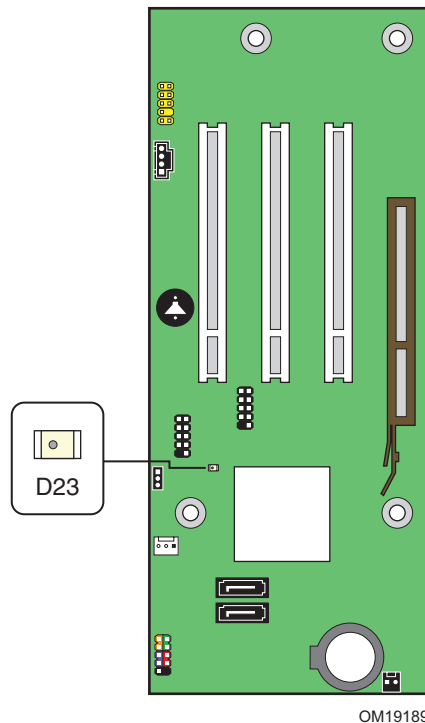

Figure 3. Location of Standby Power Indicator

Related Links:

For more information on standby current requirements for the desktop board, refer to the Technical Product Specification by going to the following link, finding the product, and selecting Product Documentation from the left-hand menu:

<http://support.intel.com/support/motherboards/desktop/>

Wake from USB**NOTE**

Wake from USB requires the use of a USB peripheral that supports wake from USB.

USB bus activity wakes the computer from an ACPI S1 or S3 state.

Wake from PS/2 Keyboard/Mouse

PS/2 keyboard/mouse activity wakes the computer from an ACPI S1 or S3 state.

PME# Wakeup Support

When the PME# signal on the PCI bus is asserted, the computer wakes from an ACPI S1, S3, or S5 state.

Speaker

A speaker is mounted on the desktop board. The speaker provides audible error code (beep code) information during the Power-On Self-Test (POST).

Battery

A battery on the desktop board keeps the values in CMOS RAM and the clock current when the computer is turned off. Go to page 48 for instructions on how to replace the battery.

Real-Time Clock

The desktop board has a time-of-day clock and 100-year calendar. The battery on the desktop board keeps the clock current when the computer is turned off.

2 Installing and Replacing Desktop Board Components

This chapter tells you how to:

- Install the I/O shield
- Install and remove the desktop board
- Install and remove a processor
- Install and remove memory
- Install and remove an AGP card
- Connect the IDE and Serial ATA cables
- Connect to the internal headers
- Connect to the chassis fan and power connectors
- Set the BIOS configuration jumper
- Clear passwords
- Replace the battery

Before You Begin



CAUTIONS

The procedures in this chapter assume familiarity with the general terminology associated with personal computers and with the safety practices and regulatory compliance required for using and modifying electronic equipment.

Disconnect the computer from its power source and from any telecommunications links, networks, or modems before performing any of the procedures described in this chapter. Failure to disconnect power, telecommunications links, networks, or modems before you open the computer or perform any procedures can result in personal injury or equipment damage. Some circuitry on the board can continue to operate even though the front panel power button is off.

Follow these guidelines before you begin:

- Always follow the steps in each procedure in the correct order.
- Set up a log to record information about your computer, such as model, serial numbers, installed options, and configuration information.
- Electrostatic discharge (ESD) can damage components. Perform the procedures described in this chapter only at an ESD workstation using an antistatic wrist strap and a conductive foam pad. If such a station is not available, you can provide some ESD protection by wearing an antistatic wrist strap and attaching it to a metal part of the computer chassis.

Installation Precautions

When you install and test the Intel desktop board, observe all warnings and cautions in the installation instructions.

To avoid injury, be careful of:

- Sharp pins on connectors
- Sharp pins on printed circuit assemblies
- Rough edges and sharp corners on the chassis
- Hot components (such as processors, voltage regulators, and heat sinks)
- Damage to wires that could cause a short circuit

Observe all warnings and cautions that instruct you to refer computer servicing to qualified technical personnel.

Prevent Power Supply Overload

Do not overload the power supply output. To avoid overloading the power supply, make sure that the calculated total current loads of all the modules within the computer is less than the output current rating of each of the power supplies output circuits.

Observe Safety and Regulatory Requirements

Read and adhere to the instructions in this section and the instructions supplied with the chassis and associated modules. If you do not follow these instructions and the instructions provided by the chassis and module suppliers, you increase safety risk and the possibility of noncompliance with regional laws and regulations. If the instructions for the chassis are inconsistent with these instructions or the instructions for associated modules, contact the supplier's technical support to find out how you can ensure that your computer meets safety and regulatory requirements.

Related Links

For information about regulatory compliance, go to Appendix B on page 57.

Installing the I/O Shield

The desktop board comes with an I/O shield. When installed in the chassis, the shield blocks radio frequency transmissions, protects internal components from dust and foreign objects, and promotes correct airflow within the chassis.

Install the I/O shield before installing the desktop board in the chassis. Place the shield inside the chassis as shown in Figure 4. Press the shield into place so that it fits tightly and securely. If the shield doesn't fit, obtain a properly-sized shield from the chassis supplier.

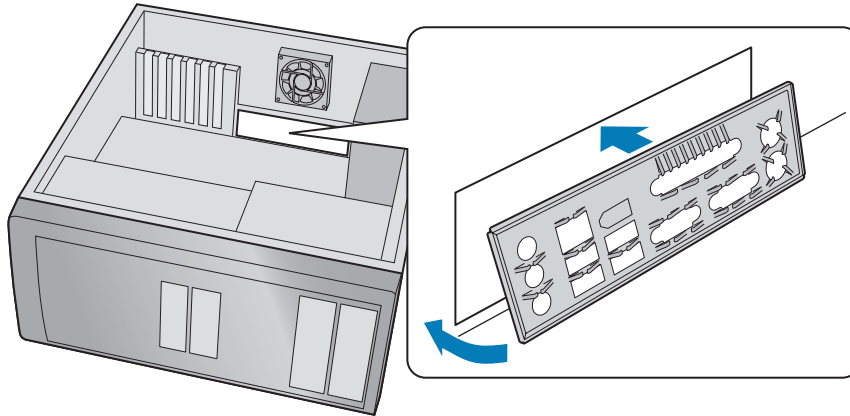

OM19172

Figure 4. Installing the I/O Shield

Installing and Removing the Desktop Board



CAUTION

Only qualified technical personnel should do this procedure. Disconnect the computer from its power source before performing the procedures described here. Failure to disconnect the power before you open the computer can result in personal injury or equipment damage.

Refer to your chassis manual for instructions on installing and removing the desktop board.

Figure 5 shows the location of the mounting screw holes for Desktop Board D865GSA.

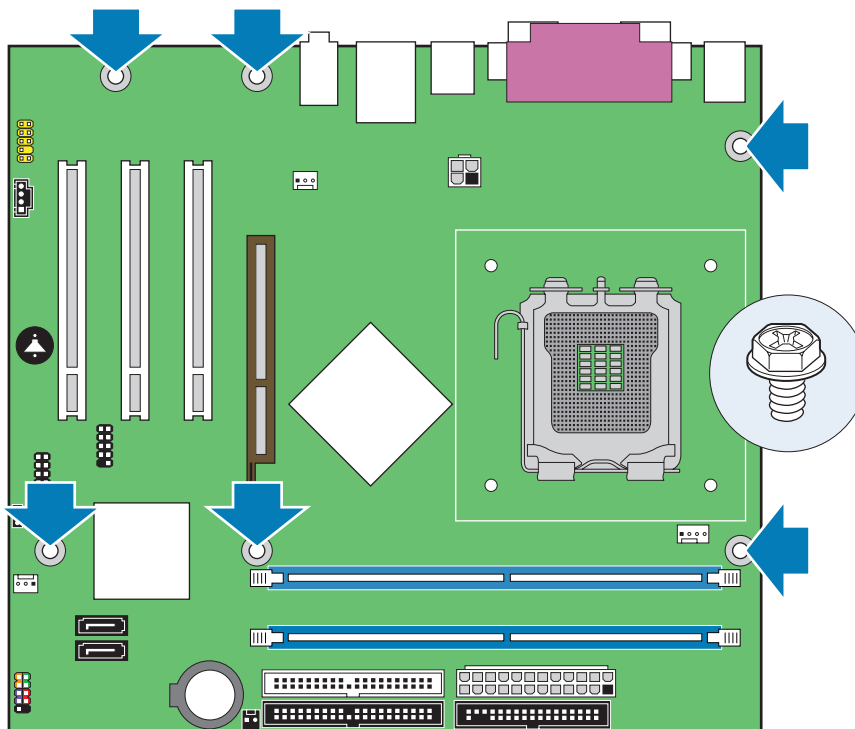

OM19173

Figure 5. Desktop Board D865GSA Mounting Screw Hole Locations

Installing and Removing a Processor

Instructions on how to install the processor on the desktop board are given below.

Installing a Processor



CAUTION

Before installing or removing the processor, make sure the AC power has been removed by unplugging the power cord from the computer; the standby power LED should not be lit (see Figure 3 on page 20). Failure to do so could damage the processor and the board.

To install a processor, follow these instructions:

1. Observe the precautions in "Before You Begin" on page 23.
2. Open the socket lever by pushing the lever down and away from the socket (Figure 6, A and B).

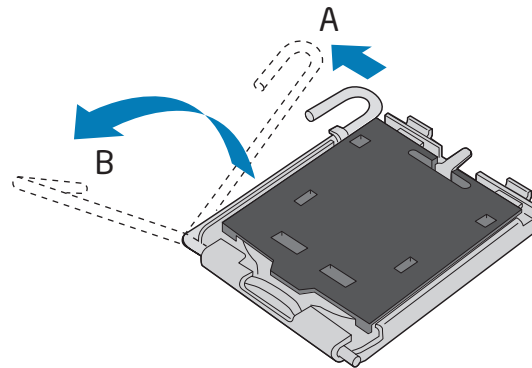

OM19077

Figure 6. Lift the Socket Lever

3. Lift the load plate (Figure 7, C). Do not touch the socket contacts (Figure 7, D).

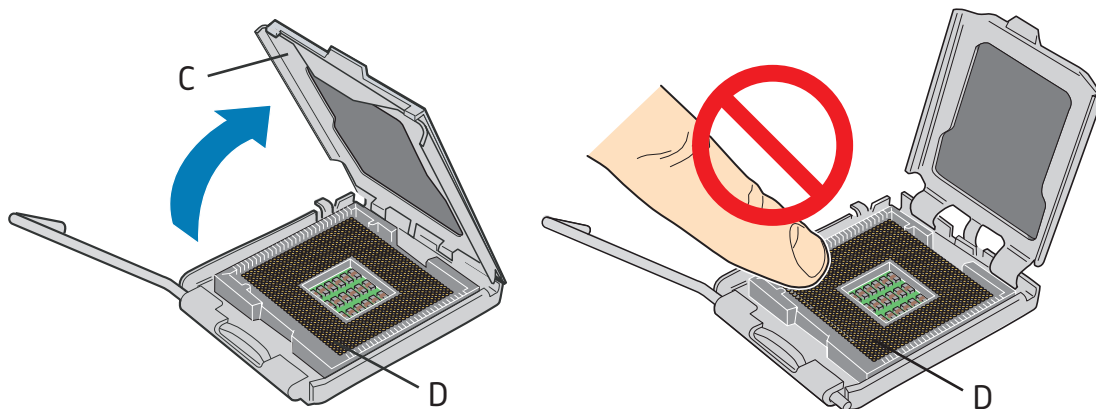

OM19078

Figure 7. Lift the Load Plate

4. Remove the plastic protective socket cover from the load plate (Figure 8, E). Do not discard the protective socket cover. Always replace the socket cover if the processor is removed from the socket.

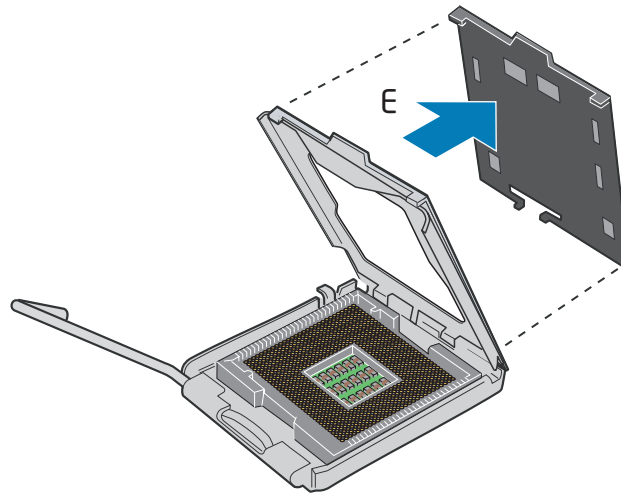

OM19079

Figure 8. Remove the Protective Socket Cover

5. Remove the processor from its protective cover. Hold the processor only at the edges, being careful not to touch the bottom of the processor (see Figure 9). Do not discard the protective processor cover. Always replace the processor cover if the processor is removed from the socket.

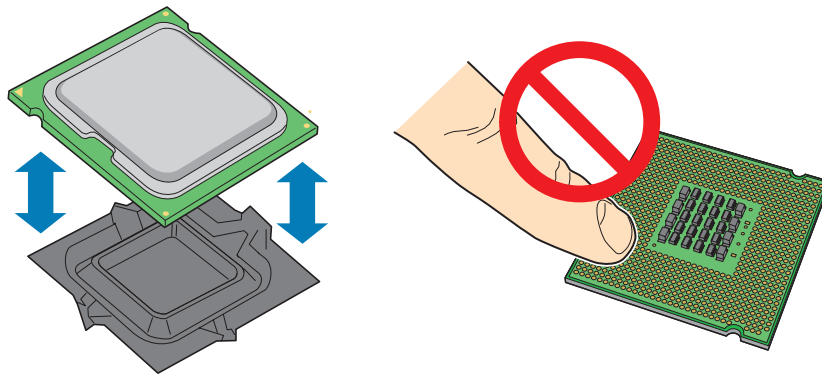

OM19080

Figure 9. Remove the Processor from the Protective Processor Cover

6. Hold the processor with your thumb and index fingers oriented as shown in Figure 10. Make sure fingers align to the socket cutouts (Figure 10, F). Align notches (Figure 10, G) with the socket (Figure 10, H). Lower the processor straight down without tilting or sliding the processor in the socket.

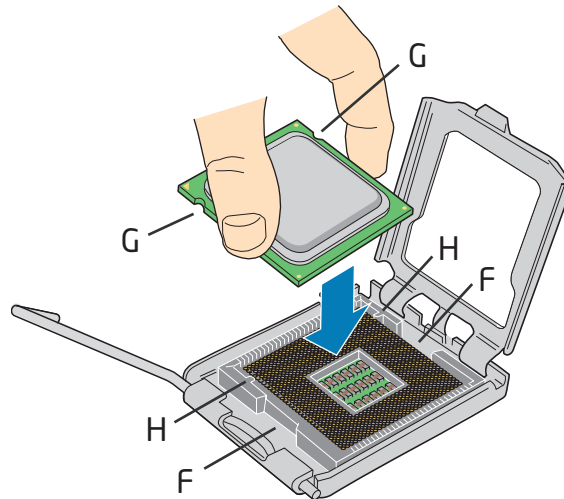

OM19081

Figure 10. Install the Processor

7. Pressing down on the load plate (Figure 11, I) close and engage the socket lever (Figure 11, J).

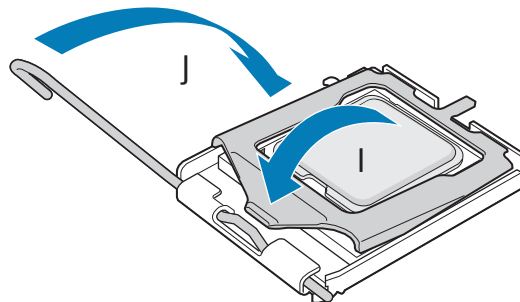

OM19082

Figure 11. Close the Load Plate

Installing the Processor Fan Heat Sink

Desktop Board D865GSA has an integrated processor fan heat sink retention mechanism (RM). For instructions on how to attach the processor fan heat sink to the integrated processor fan heat sink RM, refer to the boxed processor manual or the Intel World Wide Web site at:

[Integration of the Boxed Intel® Pentium® 4 Processor in the 775-Land Package](#)

Connecting the Processor Fan Heat Sink Cable

Connect the processor fan heat sink cable to the 4-pin processor fan header (see Figure 12). A fan with a 4-pin connector as shown in Figure 12, A is recommended; however, a fan with a 3-pin connector (Figure 12, B) can be used. Since the 3-pin fan cannot use the on-board fan control, the fan will always operate at full speed.

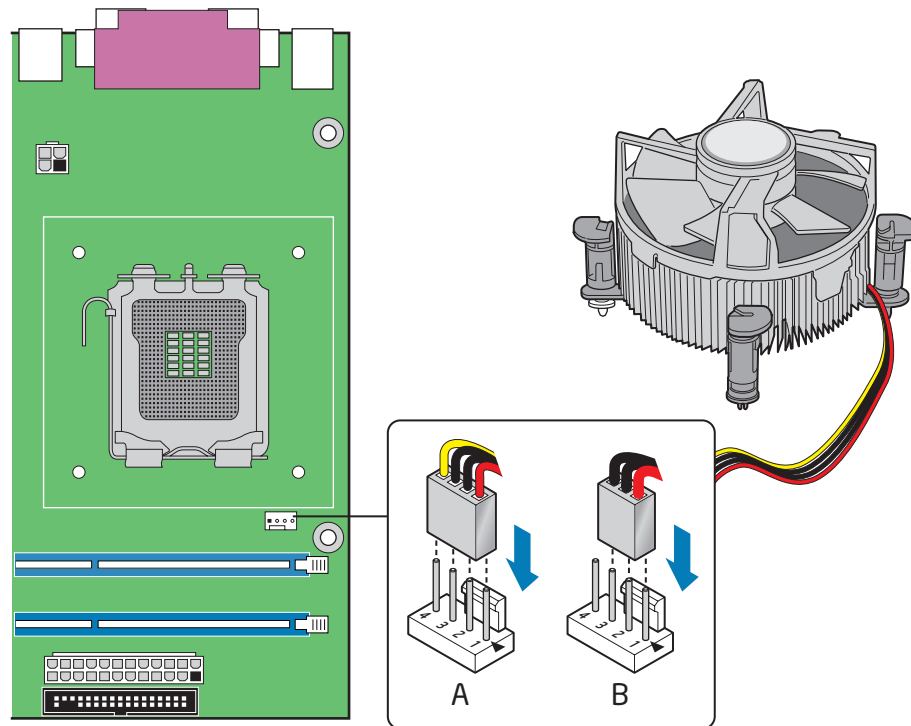

OM19174

Figure 12. Connecting the Processor Fan Heat Sink Cable to the Processor Fan Header

Removing the Processor

For instructions on how to remove the processor fan heat sink and processor, refer to the processor installation manual or the Intel World Wide Web site at:

[Integration of the Boxed Intel® Pentium® 4 Processor in the 775-Land Package](#)

Installing and Removing Memory



NOTE

To be fully compliant with all applicable Intel SDRAM memory specifications, the board requires DIMMs that support the Serial Presence Detect (SPD) data structure. You can access the PC Serial Presence Detect Specification at:

http://www.intel.com/technology/memory/ddr/specs/dda18c32_64_128x72ag_a.pdf

The desktop board has two 184-pin DDR DIMM sockets providing Channel A and Channel B. For dual-channel performance, install a matched pair of DIMMs equal in speed and size (see Figure 13).

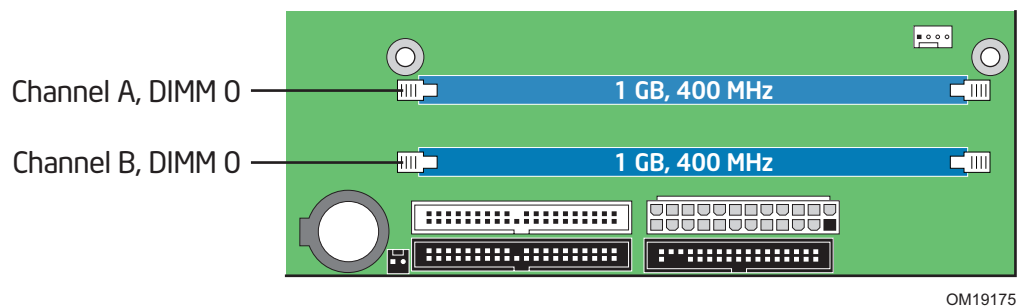

Figure 13. Dual Channel Memory Configuration Example



NOTE

All other memory configurations will result in single channel memory operation.

To make sure you have the correct DIMM, place it on the illustration of the DDR DIMM in Figure 14. All the notches should match with the DDR DIMM.

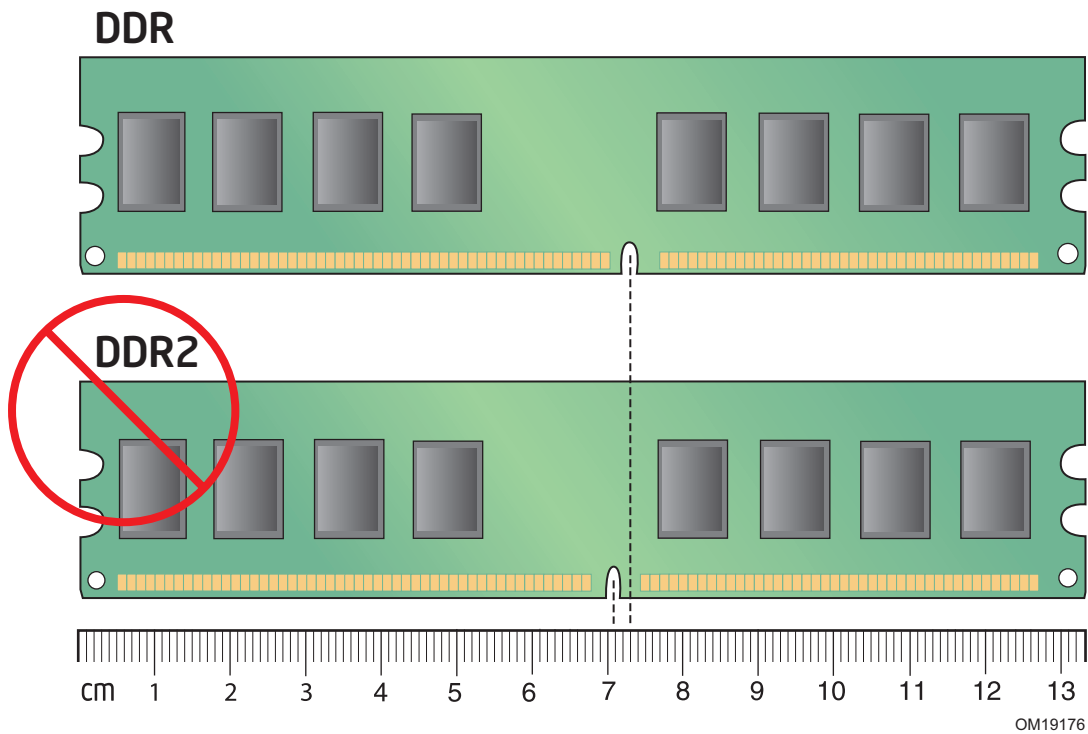
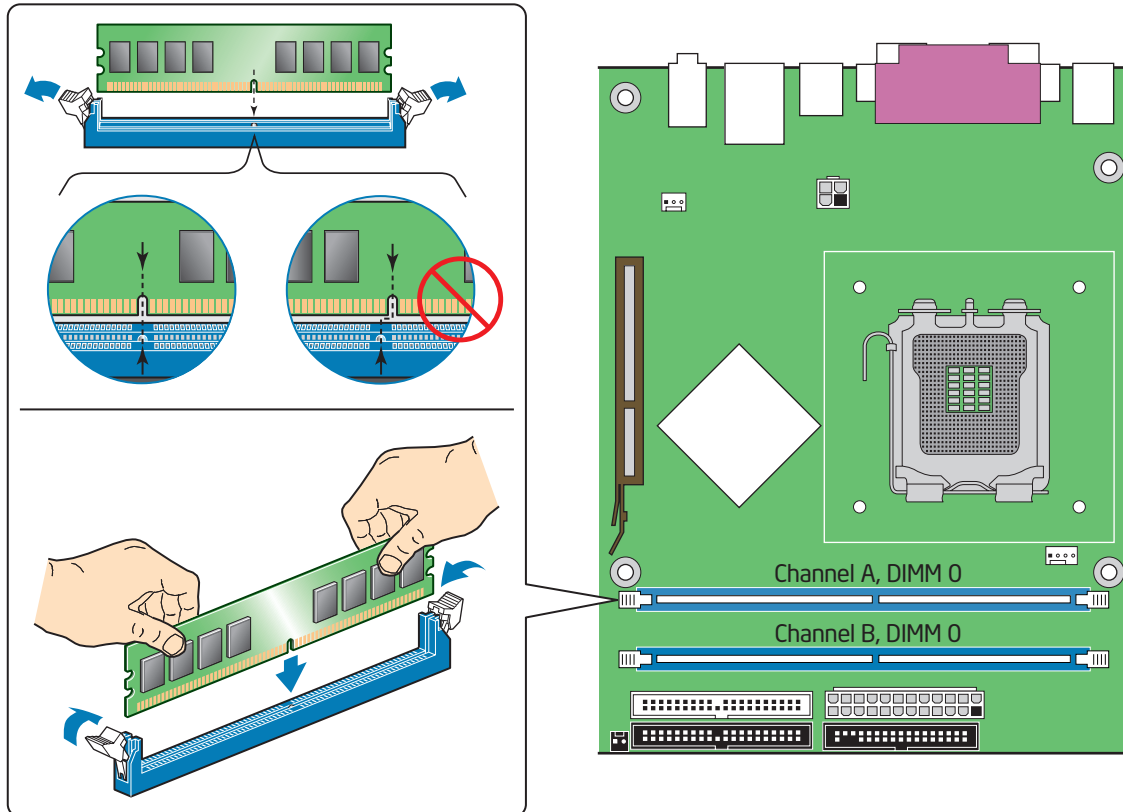

Figure 14. Use DDR DIMMs

Installing DIMMs

To install a DIMM, follow these steps:

1. Observe the precautions in "Before You Begin" on page 23.
2. Turn off all peripheral devices connected to the computer. Turn off the computer and disconnect the AC power cord.
3. Remove the computer's cover and locate the DIMM sockets (see Figure 15).



OM19177

Figure 15. Installing a DIMM

4. Make sure the clips at either end of the DIMM socket(s) are pushed outward to the open position.
5. Holding the DIMM by the edges, remove it from its anti-static package.
6. Position the DIMM above the socket. Align the small notch at the bottom edge of the DIMM with the key in the socket (see inset in Figure 15).
7. Insert the bottom edge of the DIMM into the socket.
8. When the DIMM is inserted, push down on the top edge of the DIMM until the retaining clips snap into place. Make sure the clips are firmly in place.
9. Replace the computer's cover and reconnect the AC power cord.

Removing DIMMs

To remove a DIMM, follow these steps:

1. Observe the precautions in "Before You Begin" on page 23.
2. Turn off all peripheral devices connected to the computer. Turn off the computer.
3. Remove the AC power cord from the computer.
4. Remove the computer's cover.
5. Gently spread the retaining clips at each end of the DIMM socket. The DIMM pops out of the socket.
6. Hold the DIMM by the edges, lift it away from the socket, and store it in an anti-static package.
7. Reinstall and reconnect any parts you removed or disconnected to reach the DIMM sockets.
8. Replace the computer's cover and reconnect the AC power cord.

Installing and Removing an AGP Card



CAUTION

When installing an AGP card on the desktop board, ensure that the card is fully seated in the connector before you power on the system. If the card is not fully seated in the connector, an electrical short may result across the connector pins. Depending on the over-current protection of the power supply, certain desktop board components and/or traces may be damaged.

Installing an AGP Card

1. Observe the precautions in "Before You Begin" on page 23.
2. Place the card in the AGP connector (Figure 16, A) and press down on the card until it is completely seated in the connector and the card retention notch snaps into place around the retention mechanism pin on the connector.
3. Secure the card's metal bracket to the chassis back panel with a screw (Figure 16, B).

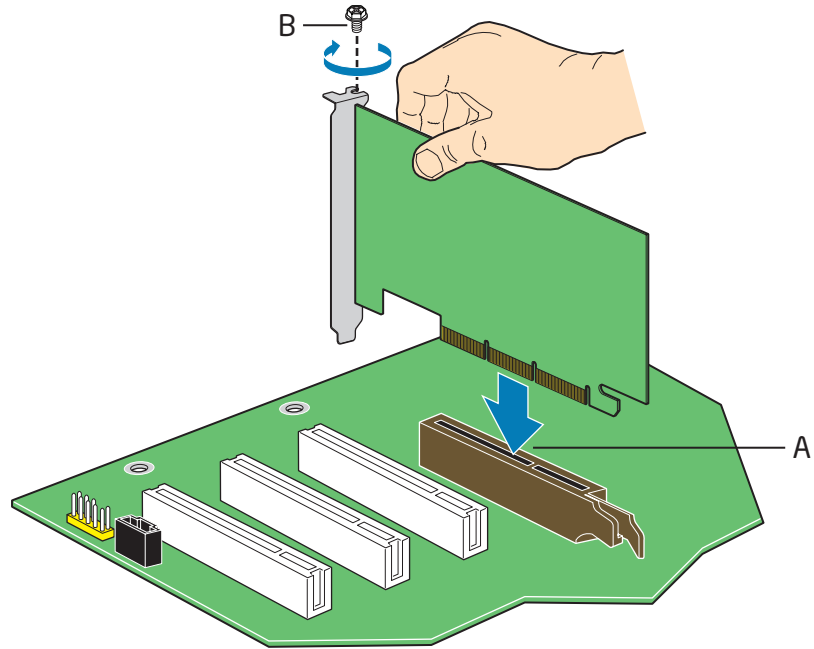

OM19178

Figure 16. Installing an AGP Card

Removing an AGP Card

Follow these instructions to remove the AGP card from the retention mechanism:

1. Observe the precautions in "Before You Begin" on page 23.
2. Remove the screw (Figure 17, A) that secures the card's metal bracket to the chassis back panel.
3. Push back on the retention mechanism lever (Figure 17, B) until the retention pin completely clears the notch in the card.
4. Pull the card straight up.

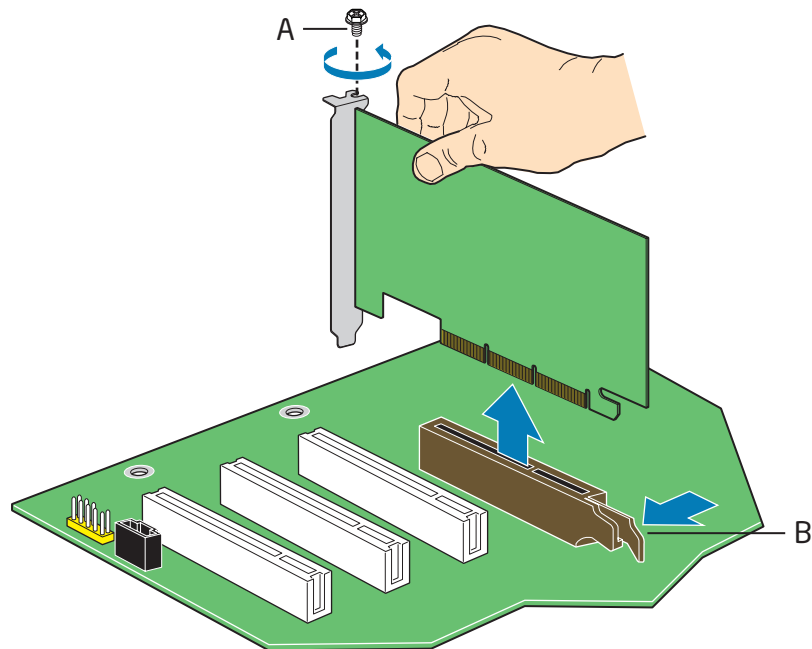

OM19179

Figure 17. Removing an AGP Card

Connecting the IDE Cables

Each IDE cable can connect two drives to the desktop board. The cables support the ATA-66/100 transfer protocol. Figure 18 shows the correct installation of the cable.



NOTES

ATA-66/100 compatible cables are backward compatible with drives using slower IDE transfer protocols. If an ATA-66/100 disk drive and a disk drive using any other IDE transfer protocol are attached to the same cable, the maximum transfer rate between the drives may be reduced to that of the slowest drive.

Do not connect an ATA device as a slave on the same IDE cable as an ATAPI master device. For example, do not connect an ATA hard drive as a slave to an ATAPI CD-ROM drive.

For correct function of the cable:

- Observe the precautions in "Before You Begin" on page 23.
- Attach the cable end with the single connector (blue) to the Intel desktop board (Figure 18, A).
- Attach the cable end with the two closely spaced connectors (gray and black) to the drives (Figure 18, B).

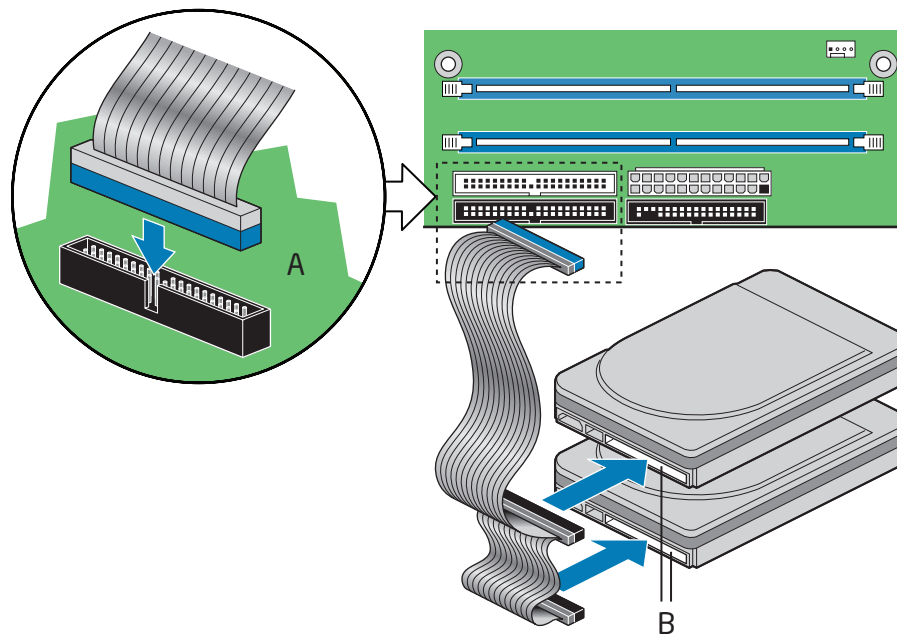

OM19180

Figure 18. Connecting the IDE Cable

Connecting the Serial ATA (SATA) Cable

The SATA cable (4-conductor) supports the Serial ATA protocol and connects a single drive to the desktop board. For correct cable function:

1. Observe the precautions in "Before You Begin" on page 23.
2. Attach the locking cable end to the connector on the board (Figure 19, A).
3. Attach the cable end without the lock to the drive (Figure 19, B).

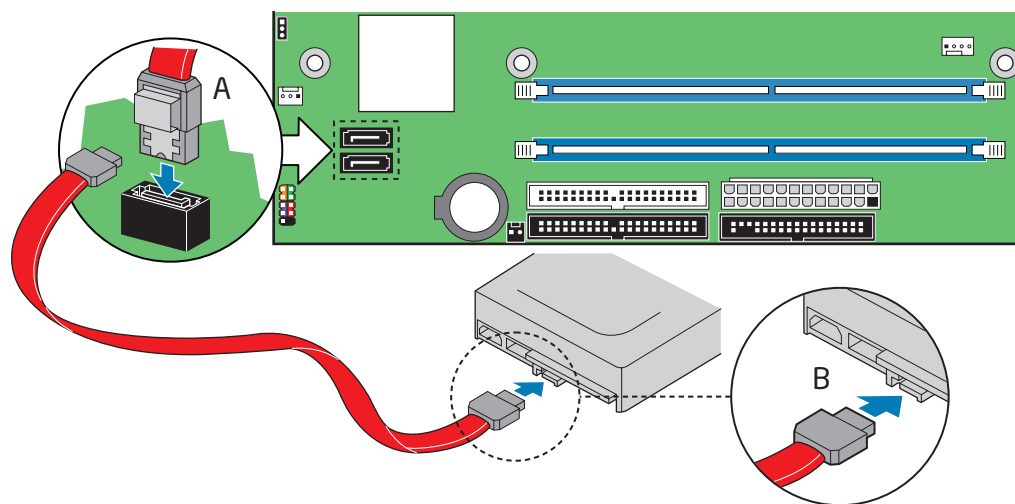

OM19181

Figure 19. Connecting the Serial ATA Cable

Connecting Internal Headers

Before connecting cables to the internal headers, observe the precautions in "Before You Begin" on page 23. Figure 20 shows the location of the internal headers.

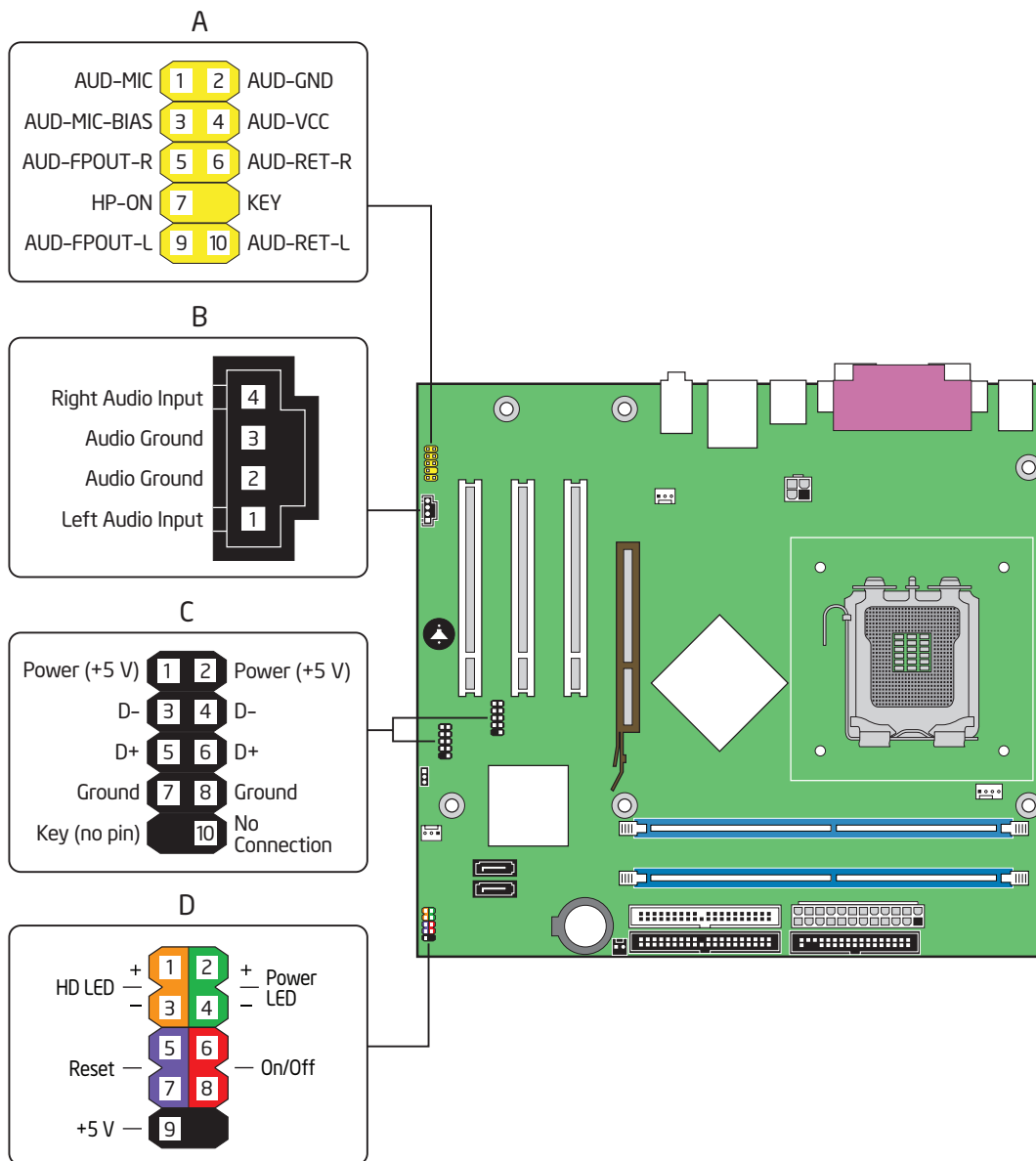

OM19182

Item	Description
A	Front panel audio
B	CD-ROM audio
C	USB 2.0
D	Front panel

Figure 20. Internal Headers

Installing a Front Panel Audio Solution

Figure 20, A on page 39 shows the location of the yellow front panel audio header. Table 6 shows the pin assignments for the front panel audio header.

Table 6. Audio Header Signal Names

Pin	Signal Name	Pin	Signal Name
1	AUD-MIC	2	AUD-GND
3	AUD-MIC-BIAS	4	AUD-VCC
5	AUD-FPOUT-R	6	AUD-RET-R
7	HP-ON	8	KEY
9	AUD-FPOUT-L	10	AUD-RET-L

To install the cable that connects a front panel audio solution to the front panel audio header, follow these steps:

1. Observe the precautions in “Before You Begin” on page 23.
2. Turn off all peripheral devices connected to the computer. Turn off the computer and disconnect the AC power cord.
3. Remove the cover.
4. Locate the front panel audio header. Remove the two jumpers from the header to disable the back panel audio connectors.
5. Install a correctly keyed and shielded front panel audio cable.
6. Connect the audio cable to the front panel audio solution.
7. Replace the cover.

To restore back panel operations, follow these steps:

1. Observe the precautions in “Before You Begin” on page 23.
2. Turn off all peripheral devices connected to the computer. Turn off the computer and disconnect the AC power cord.
3. Remove the cover.
4. Remove the front panel audio cable.
5. Install a jumper on pins 5-6 (rear R channel).
6. Install a jumper on pins 9-10 (rear L channel).
7. Replace the cover.

Connecting to the CD-ROM Audio Header

Before connecting to the CD-ROM audio header, observe the precautions in "Before You Begin" on page 23. See Figure 20, B on page 39 for the location of the header. Table 7 shows the pin assignments for the front panel header.

Table 7. CD-ROM Audio Header Signal Names

Pin	Signal Name
1	Left audio input
2	Audio ground
3	Right audio input
4	Audio ground

Connecting to the USB 2.0 Header

Before connecting to the USB 2.0 header, observe the precautions in "Before You Begin" on page 23. See Figure 20, C on page 39 for the location of the black USB 2.0 header. Table 8 shows the pin assignments for the USB 2.0 header.

Table 8. USB 2.0 Header Signal Names

USB Port A		USB Port B	
Pin	Signal Name	Pin	Signal Name
1	POWER	2	POWER
3	D-	4	D-
5	D+	6	D+
7	GND	8	GND
9	KEY	10	NO CONNECT

Note: USB ports may be assigned as needed.

Connecting to the Front Panel Header

Before connecting to the front panel header, observe the precautions in "Before You Begin" on page 23. See Figure 20, D on page 39 for the location of the multi-colored front panel header. Table 9 shows the pin assignments for the front panel header.

Table 9. Front Panel Header Signal Names

Pin	Signal	In/Out	Description	Pin	Signal	In/Out	Description
Hard Drive Activity LED (Orange)				Power LED (Green)			
1	HD_PWR	Out	Hard disk LED pull-up (330 Ω) to +5 V	2	HDR_BLNK_GRN	Out	Front panel green LED
3	HDA#	Out	Hard disk active LED	4	HDR_BLNK_YEL	Out	Front panel yellow LED
Reset Switch (Blue)				On/Off Switch (Red)			
5	GND		Ground	6	SWITCH_ON#	In	Power switch
7	FP_RESET#	In	Reset switch	8	GND		Ground
Power (Black)				Not Connected (Black)			
9	+ 5 V		Power	10	N/C		No pin

Connecting Chassis Fan and Power Cables

Connecting Chassis Fan Cables

Connect the chassis fan cables to the 3-pin fan headers on the desktop board. Figure 21 shows the location of the chassis fan headers.

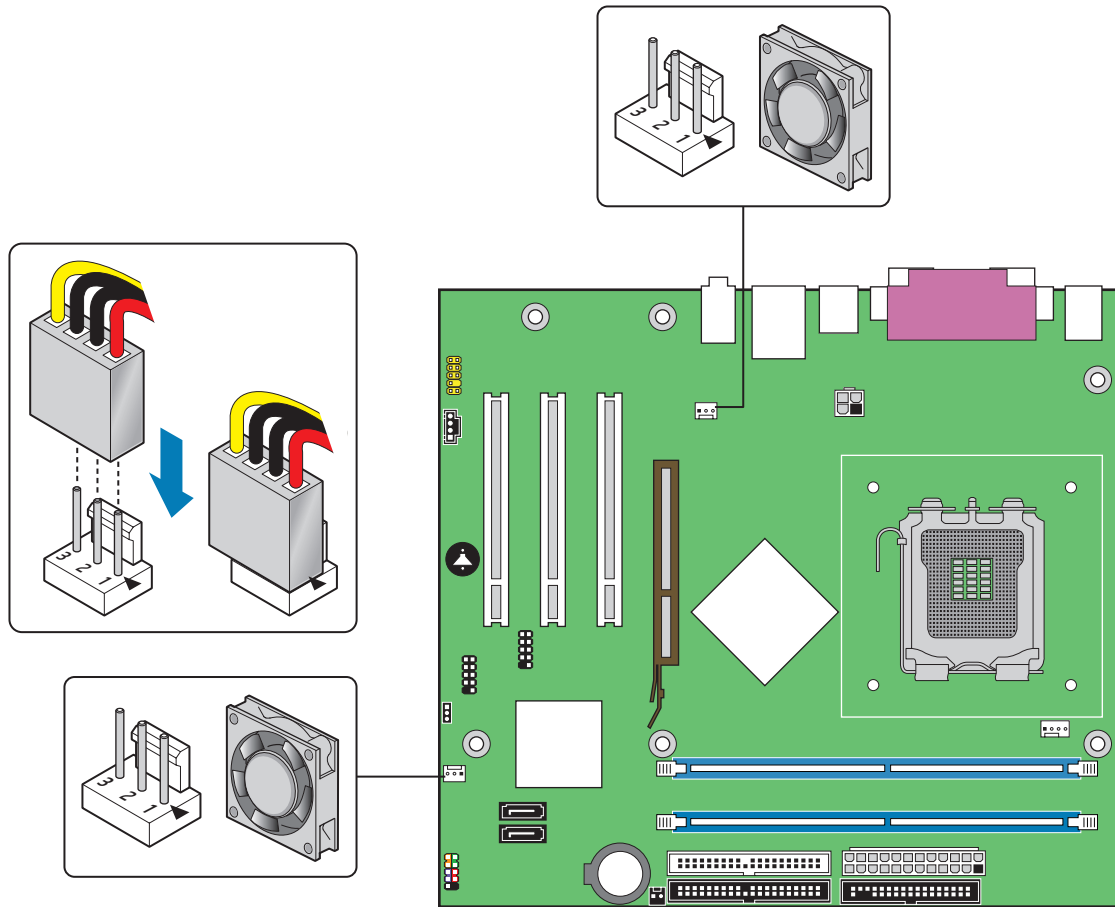

OM19183

Figure 21. Location of Chassis Fan Headers

Connecting Power Cables



CAUTION

Failure to use the appropriate power supply and/or not connecting the 12 V (2 x 2 pin) power connector to the desktop board may result in damage to the board or the system may not function properly.

See Table 3 on page 13 for power supply requirements.

The 2 x 12 pin main power connector on the desktop board is backwards compatible with ATX12V power supplies with 2 x 10 pin connectors. Figure 22 shows the location of the desktop board power connectors.

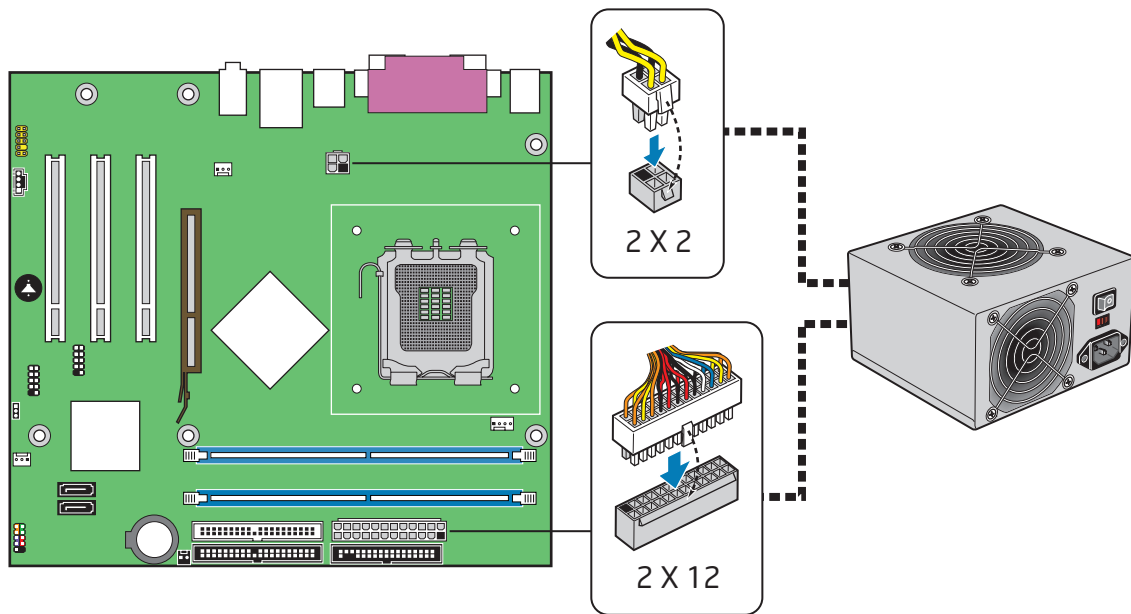

OM19184

Figure 22. Connecting Power Supply Cables

1. Observe the precautions in "Before You Begin" on page 23.
2. Connect the main power supply cable to the 2 x 12 pin connector.
3. Connect the 12 V processor core voltage power supply cable to the 2 x 2 pin connector.

Other Connectors

Figure 23 shows the location of the other connectors on the desktop board.

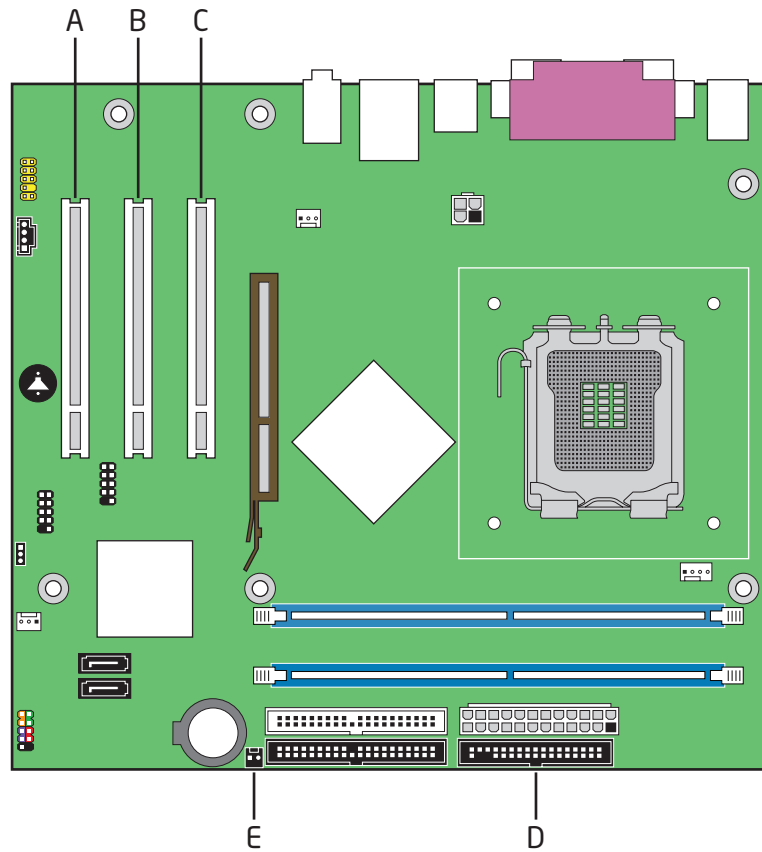

OM19185

Item	Description
A	PCI bus add-in card connector 3
B	PCI bus add-in card connector 2
C	PCI bus add-in card connector 1
D	Diskette drive connector
E	Chassis intrusion connector

Figure 23. Location of Other Connectors

Setting the BIOS Configuration Jumper



NOTE

Always turn off the power and unplug the power cord from the computer before moving the jumper. Moving the jumper with the power on may result in unreliable computer operation.

Figure 24 shows the location of the desktop board's BIOS configuration jumper block.

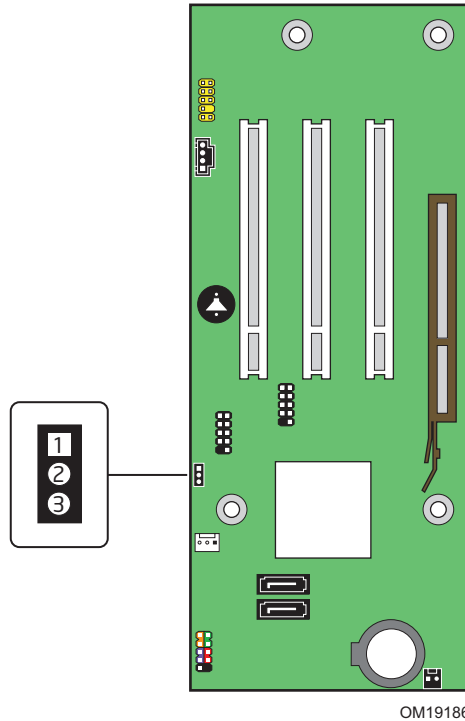
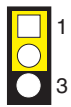
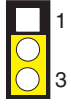



Figure 24. Location of the BIOS Configuration Jumper Block

The three-pin BIOS jumper block enables all board configurations to be done in the BIOS Setup program. Table 10 shows the jumper settings for the BIOS Setup program modes.

Table 10. Jumper Settings for the BIOS Setup Program Modes

Jumper Setting	Mode	Description
	Normal (default) (1-2)	The BIOS uses the current configuration and passwords for booting.
	Configure (2-3)	After the Power-On Self-Test (POST) runs, the BIOS displays the Maintenance Menu. Use this menu to clear passwords.
	Recovery (None)	The BIOS recovers data in the event of a failed BIOS update.

Clearing Passwords

This procedure assumes that the board is installed in the computer and the configuration jumper block is set to normal mode.

1. Observe the precautions in "Before You Begin" on page 23.
2. Turn off all peripheral devices connected to the computer. Turn off the computer. Disconnect the computer's power cord from the AC power source (wall outlet or power adapter).
3. Remove the computer cover.
4. Find the BIOS configuration jumper block (see Figure 24).
5. Place the jumper on pins 2-3 as shown below.

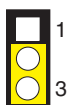

6. Replace the cover, plug in the computer, turn on the computer, and allow it to boot.
7. The computer starts the Setup program. Setup displays the Maintenance menu.
8. Use the arrow keys to select Clear Passwords. Press <Enter> and Setup displays a pop-up screen requesting that you confirm clearing the password. Select Yes and press <Enter>. Setup displays the maintenance menu again.
9. Press <F10> to save the current values and exit Setup.
10. Turn off the computer. Disconnect the computer's power cord from the AC power source.
11. Remove the computer cover.
12. To restore normal operation, place the jumper on pins 1-2 as shown below.

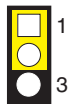

13. Replace the cover, plug in the computer, and turn on the computer.

Back Panel Connectors



NOTE

The line out connector, located on the back panel, is designed to power either headphones or amplified speakers only. Poor audio quality may occur if passive (non-amplified) speakers are connected to this output.

Figure 25 shows the back panel connectors.

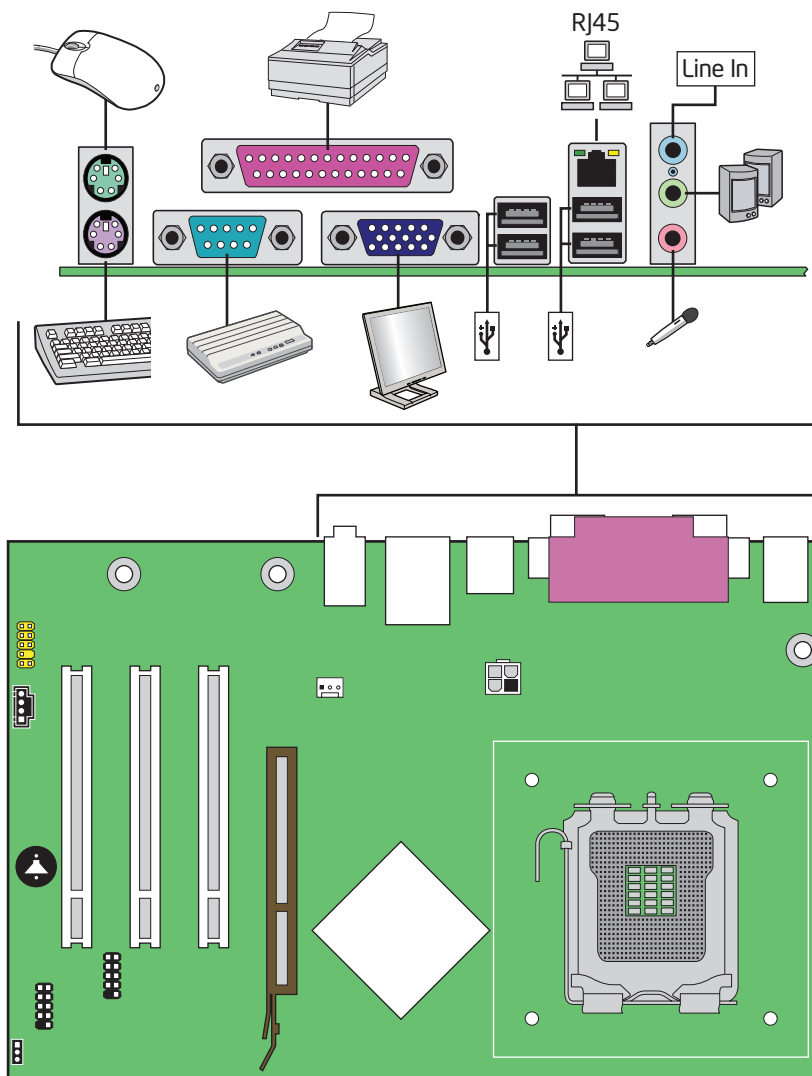

OM19187

Figure 25. Back Panel Connectors

Replacing the Battery

A coin-cell battery (CR2032) powers the real-time clock and CMOS memory. When the computer is not plugged into a wall socket, the battery has an estimated life of three years. When the computer is plugged in, the standby current from the power supply extends the life of the battery. The clock is accurate to ± 13 minutes/year at 25 °C with 3.3 VSB applied.

When the voltage drops below a certain level, the BIOS Setup program settings stored in CMOS RAM (for example, the date and time) might not be accurate. Replace the battery with an equivalent one. Figure 26 on page 52 shows the location of the battery.



CAUTION

Risk of explosion if the battery is replaced with an incorrect type. Batteries should be recycled where possible. Disposal of used batteries must be in accordance with local environmental regulations.



PRECAUTION

Risque d'explosion si la pile usagée est remplacée par une pile de type incorrect. Les piles usagées doivent être recyclées dans la mesure du possible. La mise au rebut des piles usagées doit respecter les réglementations locales en vigueur en matière de protection de l'environnement.



FORHOLDSREGEL

Eksplosionsfare, hvis batteriet erstattes med et batteri af en forkert type. Batterier bør om muligt genbruges. Bortskaffelse af brugte batterier bør foregå i overensstemmelse med gældende miljølovgivning.



OBS!

Det kan oppstå eksplosjonsfare hvis batteriet skiftes ut med feil type. Brukte batterier bør kastes i henhold til gjeldende miljølovgivning.



VIKTIGT!

Risk för explosion om batteriet ersätts med felaktig batterityp. Batterier ska kasseras enligt de lokala miljövårdsbestämmelserna.



VARO

Räjähdyksvaara, jos pariston tyyppi on väärä. Paristot on kierrätettävä, jos se on mahdollista. Käytetyt paristot on hävitettävä paikallisten ympäristömääräysten mukaisesti.



VORSICHT

Bei falschem Einsetzen einer neuen Batterie besteht Explosionsgefahr. Die Batterie darf nur durch denselben oder einen entsprechenden, vom Hersteller empfohlenen Batterietyp ersetzt werden. Entsorgen Sie verbrauchte Batterien den Anweisungen des Herstellers entsprechend.

**AVVERTIMENTO**

Esiste il pericolo di un esplosione se la pila non viene sostituita in modo corretto. Utilizzare solo pile uguali o di tipo equivalente a quelle consigliate dal produttore. Per disfarsi delle pile usate, seguire le istruzioni del produttore.

**PRECAUCIÓN**

Existe peligro de explosión si la pila no se cambia de forma adecuada. Utilice solamente pilas iguales o del mismo tipo que las recomendadas por el fabricante del equipo. Para deshacerse de las pilas usadas, siga igualmente las instrucciones del fabricante.

**WAARSCHUWING**

Er bestaat ontploffingsgevaar als de batterij wordt vervangen door een onjuist type batterij. Batterijen moeten zoveel mogelijk worden gerecycled. Houd u bij het weggooien van gebruikte batterijen aan de plaatselijke milieuwetgeving.

**ATENÇÃO**

Haverá risco de explosão se a bateria for substituída por um tipo de bateria incorreto. As baterias devem ser recicladas nos locais apropriados. A eliminação de baterias usadas deve ser feita de acordo com as regulamentações ambientais da região.

**AŚCIAROŻZNAŚĆ**

Існуе рызыка выбуху, калі заменены акумулятар непраўльнага тыпу. Акумулятары павінны, па магчымасці, перепрацоўвацца. Пазбаўляцца ад старых акумулятараў патрэбна згодна з мясцовымі заканадаўствам па экалогіі.

**UPOZORNĚNÍ**

V případě výměny baterie za nesprávný druh může dojít k výbuchu. Je-li to možné, baterie by měly být recyklovány. Baterie je třeba zlikvidovat v souladu s místními předpisy o životním prostředí.

**Προσοχή**

Υπάρχει κίνδυνος για έκρηξη σε περίπτωση που η μπαταρία αντικατασταθεί από μία λανθασμένου τύπου. Οι μπαταρίες θα πρέπει να ανακυκλώνονται όταν κάτι τέτοιο είναι δυνατό. Η απόρριψη των χρησιμοποιημένων μπαταριών πρέπει να γίνεται σύμφωνα με τους κατά τόπο περιβαλλοντικούς κανονισμούς.

**VIGYAZAT**

Ha a telepet nem a megfelelő típusú telepre cseréli, az felrobbanhat. A telepeket lehetőség szerint újra kell hasznosítani. A használt telepeket a helyi környezetvédelmi előírásoknak megfelelően kell kiselejtezni.

**注意**

異なる種類の電池を使用すると、爆発の危険があります。リサイクルが可能な地域であれば、電池をリサイクルしてください。使用後の電池を破棄する際には、地域の環境規制に従ってください。



AWAS

Risiko letupan wujud jika bateri digantikan dengan jenis yang tidak betul. Bateri sepatutnya dikitar semula jika boleh. Pelupusan bateri terpakai mestilah mematuhi peraturan alam sekitar tempatan.



OSTRZEŻENIE

Istnieje niebezpieczeństwo wybuchu w przypadku zastosowania niewłaściwego typu baterii. Zużyte baterie należy w miarę możliwości utylizować zgodnie z odpowiednimi przepisami ochrony środowiska.



PRECAUȚIE

Risc de explozie, dacă bateria este înlocuită cu un tip de baterie necorespunzător. Bateriile trebuie reciclate, dacă este posibil. Depozitarea bateriilor uzate trebuie să respecte reglementările locale privind protecția mediului.



ВНИМАНИЕ

При использовании батарей несоответствующего типа существует риск ее взрыва. Батареи должны быть утилизированы по возможности. Утилизация батарей должна проводиться по правилам, соответствующим местным требованиям.



UPOZORNENIE

Ak batériu vymeníte za nesprávny typ, hrozí nebezpečenstvo jej výbuchu. Batérie by sa mali podľa možnosti vždy recyklovať. Likvidácia použitých batérií sa musí vykonávať v súlade s miestnymi predpismi na ochranu životného prostredia.



POZOR

Zamenjava baterije z baterijo drugačnega tipa lahko povzroči eksplozijo. Če je mogoče, baterije reciklirajte. Rabljene baterije zavržite v skladu z lokalnimi okoljevarstvenimi predpisi.



คำเตือน

ระวังการระเบิดที่เกิดจากเปลี่ยนแบตเตอรี่ผิดประเภท หากเป็นไปได้ ควรนำแบตเตอรี่ไปรีไซเคิล การทิ้งแบตเตอรี่ใช้แล้วต้องเป็นไปตามกฎข้อบังคับด้านสิ่งแวดล้อมของท้องถิ่น.



UYARI

Yanlış türde pil takıldığında patlama riski vardır. Piller mümkün olduğunda geri dönüştürülmelidir. Kullanılmış piller, yerel çevre yasalarına uygun olarak atılmalıdır.



ОСТОРОГА

Використовуйте батареї правильного типу, інакше існують ризик вибуху. Якщо можливо, використані батареї слід утилізувати. Утилізація використаних батарей має бути виконана згідно місцевих норм, що регулюють охорону довкілля.

**UPOZORNĚNÍ**

V případě výměny baterie za nesprávný druh může dojít k výbuchu. Je-li to možné, baterie by měly být recyklovány. Baterie je třeba zlikvidovat v souladu s místními předpisy o životním prostředí.

**ETTEVAATUST**

Kui patarei asendatakse uue ebasobivat tüüpi patareiga, võib tekkida plahvatusoht. Tühjad patareid tuleb võimaluse korral viia vastavasse kogumispunkti. Tühjade patareide äraviskamisel tuleb järgida kohalikke keskkonnakaitse alaseid reegleid.

**FIGYELMEZTETÉS**

Ha az elemet nem a megfelelő típusúra cseréli, felrobbanhat. Az elemeket lehetőség szerint újra kell hasznosítani. A használt elemeket a helyi környezetvédelmi előírásoknak megfelelően kell kiselejtezni.

**UZMANĪBU**

Pastāv eksplozijas risks, ja baterijas tiek nomainītas ar nepareiza veida baterijām. Ja iespējams, baterijas vajadzētu nodot attiecīgos pieņemšanas punktus. Bateriju izmešanai atkritumos jānotiek saskaņā ar vietējiem vides aizsardzības noteikumiem.

**DÉMESIO**

Naudojant netinkamo tipo baterijas įrenginys gali sprogti. Kai tik įmanoma, baterijas reikia naudoti pakartotinai. Panaudotas baterijas išmesti būtina pagal vietinius aplinkos apsaugos nuostatus.

**ATTENZJONI**

Riskju ta' splużjoni jekk il-batterija tinbidel b'tip ta' batterija mhux korrett. Il-batteriji għandhom jiġu riċiklati fejn hu possibbli. Ir-rimi ta' batteriji użati għandu jsir skond ir-regolamenti ambjentali lokali.

**OSTRZEŻENIE**

Ryzyko wybuchu w przypadku wymiany na baterie niewłaściwego typu. W miarę możliwości baterie należy poddać recyklingowi. Zużytych baterii należy pozbywać się zgodnie z lokalnie obowiązującymi przepisami w zakresie ochrony środowiska.

To replace the battery, follow these steps:

1. Observe the precautions in "Before You Begin" (see page 23).
2. Turn off all peripheral devices connected to the computer. Disconnect the computer's power cord from the AC power source (wall outlet or power adapter).
3. Remove the computer cover.
4. Locate the battery on the board (see Figure 26).
5. With a medium flat-bladed screwdriver, gently pry the battery free from its connector. Note the orientation of the "+" and "-" on the battery.
6. Install the new battery in the connector, orienting the "+" and "-" correctly.
7. Replace the computer cover.

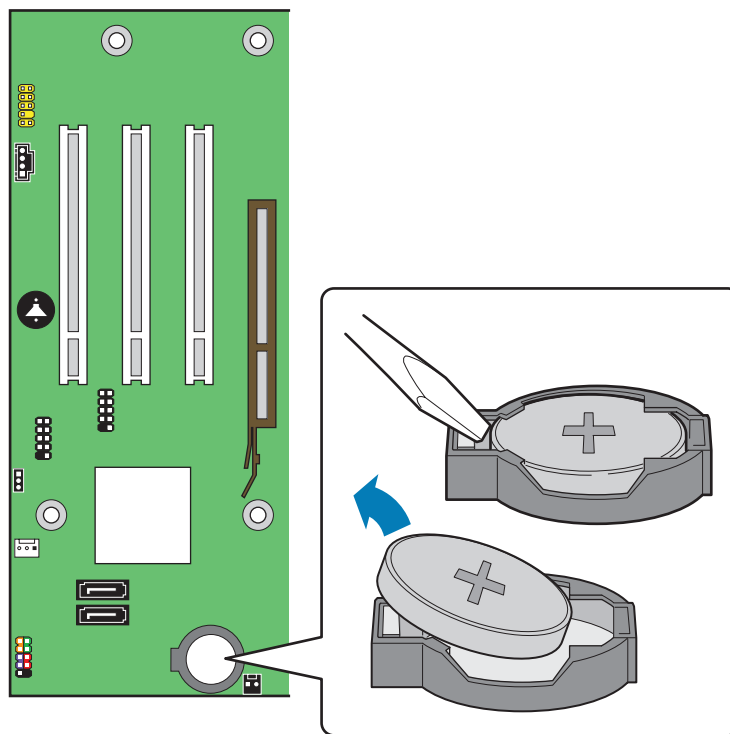

OM19188

Figure 26. Removing the Battery

3 Updating the BIOS

The BIOS Setup program can be used to view and change the BIOS settings for the computer. You can access the BIOS Setup program by pressing the <F2> key after the Power-On Self-Test (POST) memory test begins and before the operating system boot begins.

This chapter tells you how to update the BIOS by either using the Intel® Express BIOS Update utility or the Iflash Memory Update utility, and how to recover the BIOS if an update fails.

Updating the BIOS with the Intel® Express BIOS Update Utility

With the Intel Express BIOS Update utility you can update the system BIOS while in the Windows environment. The BIOS file is included in an automated update utility that combines the functionality of the Intel® Flash Memory Update Utility and the ease-of use of Windows-based installation wizards.

To update the BIOS with the Intel Express BIOS Update utility:

1. Go to the Intel World Wide Web site:
<http://support.intel.com/support/motherboards/desktop/>
2. Navigate to the D865GSA page, click “[view] Latest BIOS updates,” and select the Express BIOS Update utility file.
3. Download the file to your hard drive. (You can also save this file to a diskette. This is useful if you are updating the BIOS for multiple identical systems.)
4. Close all other applications. This step is required. Your system will be rebooted at the last Express BIOS Update window.
5. Double-click the executable file from the location on your hard drive where it was saved. This runs the update program.
6. Follow the instructions provided in the dialog boxes to complete the BIOS update.

Updating the BIOS with the Iflash Memory Update Utility

With the Iflash BIOS update utility you can update the system BIOS from a floppy disk in a USB floppy disk drive or other bootable media. The utility available on the Intel World Wide Web site provides a simple method for creating a bootable flash memory update floppy that will automatically update your BIOS.

Obtaining the BIOS Update File

You can update to a new version of the BIOS by using the BIOS update file. The BIOS update file is a compressed self-extracting archive that contains all the files you need to update the BIOS. The BIOS update file contains:

- New BIOS files
- BIOS recovery files
- Intel Flash Memory Update Utility

You can obtain the BIOS update file through your computer supplier or by navigating to the Desktop Board D865GSA page on the Intel World Wide Web site at:

<http://support.intel.com/support/motherboards/desktop>

Navigate to the D865GSA page, click “[view] Latest BIOS updates,” and select the Iflash BIOS Update utility file.



NOTE

Review the instructions distributed with the update utility before attempting a BIOS update.

The Iflash Memory Update utility allows you to:

- Update the BIOS in flash memory
- Update the language section of the BIOS

Updating the BIOS



CAUTION

The AUTOEXEC.BAT file provided with the update files updates the BIOS. Do not interrupt the process or the system may not function.

1. Boot the computer with the BIOS update diskette in drive A. During system boot, the AUTOEXEC.BAT file provided with the update files will automatically run the BIOS update process.
2. When the update process is complete, the monitor will display a message telling you to remove the diskette and to reboot the system.
3. As the computer boots, check the BIOS identifier (version number) to make sure the update was successful. If a logo appears, press <Esc> to view the POST messages.

Recovering the BIOS

It is unlikely that anything will interrupt the BIOS update; however, if an interruption occurs, the BIOS could be damaged. For information about recovering the BIOS for desktop board D865GSA, go to:

<http://support.intel.com/support/motherboards/desktop/>

A Error Messages and Indicators

Desktop Board D865GSA reports POST errors in two ways:

- By sounding a beep code
- By displaying an error message on the monitor

BIOS Beep Codes

The BIOS also issues a beep code (one long tone followed by two short tones) during POST if the video configuration fails (a faulty video card or no card installed) or if an external ROM module does not properly checksum to zero. Table 11 lists the BIOS codes.

Table 11. Beep Codes

Beep	Description
3	No memory
Siren	CPU overheat (on reboot)

BIOS Error Messages

When a recoverable error occurs during the POST, the BIOS displays an error message describing the problem. Table 12 gives an explanation of the BIOS error messages.

Table 12. BIOS Error Messages

Error Message	Explanation
PROCESSOR_THERMAL_TRIP_ERROR	CPU was previously shutdown due to a thermal event (overheating).
MULTI_BIT_ECC_ERROR	The firmware has detected that a Multi-Bit ECC Error occurred.
SINGLE_BIT_ECC_ERROR	The firmware has detected that a Single-Bit ECC Error occurred.
CMOS_BATTERY_ERROR	The firmware has detected that a CMOS battery failure occurred.
CMOS_CHECKSUM_ERROR	The firmware has detected that a CMOS Checksum Error occurred.
CMOS_TIMER_ERROR	The firmware has detected that the system date/time has not been set.
MEMORY_SIZE_DECREASE_ERROR	The firmware has detected that the system memory has decreased.
INTRUDER_DETECTION_ERROR	The system chassis was opened.
SPD_TOLER_ERROR	SERIAL PRESENCE DETECT (SPD) device data missing or inconclusive. Properly programmed SPD device data is required for reliable operation. DDR2 533 MHz memory assumed at slowest timings.
MEM_OPTIMAL_ERROR	The installed amount of memory in Channel A is not equal to the amount of memory in Channel B. Maximum memory performance is achieved with equal amounts of memory installed in each channel.

B Regulatory Compliance

This appendix contains the following regulatory compliance information for Desktop Board D865GSA:

- Safety regulations
- European Union Declaration of Conformity statement
- Product Ecology statements
- Electromagnetic Compatibility (EMC) regulations
- Product certifications

Safety Regulations

Desktop Board D865GSA complies with the safety regulations stated in Table 13 when correctly installed in a compatible chassis.

Table 13. Safety Regulations

Regulation	Title
UL 60950-1:2003/ CSA C22.2 No. 60950-1-03	Information Technology Equipment – Safety - Part 1: General Requirements (USA and Canada)
EN 60950-1:2002	Information Technology Equipment – Safety - Part 1: General Requirements (European Union)
IEC 60950-1:2001, First Edition	Information Technology Equipment – Safety - Part 1: General Requirements (International)

Place Battery Marking

There is insufficient space on this desktop board to provide instructions for replacing and disposing of the Lithium ion coin cell battery. For system safety certification, the statement below or an equivalent statement is required to be permanently and legibly marked on the chassis near the battery.



CAUTION

Risk of explosion if the battery is replaced with an incorrect type. Batteries should be recycled where possible. Disposal of used batteries must be in accordance with local environmental regulations.

Related Links

For information about replacing the battery, go to page 48.

European Union Declaration of Conformity Statement

We, Intel Corporation, declare under our sole responsibility that the product Intel® Desktop Board D865GSA is in conformity with all applicable essential requirements necessary for CE marking, following the provisions of the European Council Directive 89/336/EEC (EMC Directive) and Council Directive 73/23/EEC (Safety/Low Voltage Directive).

The product is properly CE marked demonstrating this conformity and is for distribution within all member states of the EU with no restrictions.



This product follows the provisions of the European Directives 89/336/EEC and 73/23/EEC.

Čeština Tento výrobek odpovídá požadavkům evropských směrnic 89/336/EEC a 73/23/EEC.

Dansk Dette produkt er i overensstemmelse med det europæiske direktiv 89/336/EEC & 73/23/EEC.

Dutch Dit product is in navolging van de bepalingen van Europees Directief 89/336/EEC & 73/23/EEC.

Eesti Antud toode vastab Euroopa direktiivides 89/336/EEC ja 73/23/EEC kehtestatud nõuetele.

Suomi Tämä tuote noudattaa EU-direktiivin 89/336/EEC & 73/23/EEC määräyksiä.

Français Ce produit est conforme aux exigences de la Directive Européenne 89/336/EEC & 73/23/EEC.

Deutsch Dieses Produkt entspricht den Bestimmungen der Europäischen Richtlinie 89/336/EEC & 73/23/EEC.

Ελληνικά Το παρόν προϊόν ακολουθεί τις διατάξεις των Ευρωπαϊκών Οδηγιών 89/336/ΕΟΚ και 73/23/ΕΟΚ.

Magyar E termék megfelel a 89/336/EEC és 73/23/EEC Európai Irányelv előírásainak.

Icelandic Þessi vara stenst reglugerð Evrópska Efnahags Bandalagsins númer 89/336/ EEC & 73/23/EEC.

Italiano Questo prodotto è conforme alla Direttiva Europea 89/336/EEC & 73/23/EEC.

Latviešu Šis produkts atbilst Eiropas Direktīvu 89/336/EEC un 73/23/EEC noteikumiem.

Lietuvių Šis produktas atitinka Europos direktyvų 89/336/EEC ir 73/23/EEC nuostatas.

Malti Dan il-prodott hu konformi mal-provvedimenti tad-Direttivi Ewropej 89/336/EEC u 73/23/EEC.

Norsk Dette produktet er i henhold til bestemmelsene i det europeiske direktivet 89/336/ EEC & 73/23/EEC.

Polski Niniejszy produkt jest zgodny z postanowieniami Dyrektyw Unii Europejskiej 89/336/EWG i 73/23/EWG.

Portuguese Este produto cumpre com as normas da Diretiva Europeia 89/336/EEC & 73/23/EEC.

Español Este producto cumple con las normas del Directivo Europeo 89/336/EEC & 73/23/EEC.

Slovensky Tento produkt je v súlade s ustanoveniami európskych direktív 89/336/EEC a 73/23/EEC.

Slovenščina Izdelek je skladen z določbami evropskih direktiv 89/336/EGS in 73/23/EGS.

Svenska Denna produkt har tillverkats i enlighet med EG-direktiv 89/336/EEC & 73/23/EEC.

Türkçe Bu ürün, Avrupa Birliği'nin 89/336/EEC ve 73/23/EEC yönergelerine uyar.

Product Ecology Statements

The following information is provided to address worldwide product ecology concerns and regulations.

Recycling Considerations

As part of its commitment to environmental responsibility, Intel has implemented the Intel® Product Recycling Program to allow retail consumers of Intel's branded products to return used products to select locations for proper recycling.

Please consult the http://www.intel.com/intel/other/ehs/product_ecology/Recycling_Program.htm for the details of this program, including the scope of covered products, available locations, shipping instructions, terms and conditions, etc.

中文

作为其对环境责任之承诺的部分，英特尔已实施 Intel Product Recycling Program（英特尔产品回收计划），以允许英特尔品牌产品的零售消费者将使用过的产品退还至指定地点作恰当的重复使用处理。

请参考http://www.intel.com/intel/other/ehs/product_ecology/Recycling_Program.htm了解此计划的详情，包括涉及产品之范围、回收地点、运送指导、条款和条件等。

Deutsch

Als Teil von Intels Engagement für den Umweltschutz hat das Unternehmen das Intel Produkt-Recyclingprogramm implementiert, das Einzelhandelskunden von Intel Markenprodukten ermöglicht, gebrauchte Produkte an ausgewählte Standorte für ordnungsgemäßes Recycling zurückzugeben.

Details zu diesem Programm, einschließlich der darin eingeschlossenen Produkte, verfügbaren Standorte, Versandanweisungen, Bedingungen usw., finden Sie auf der http://www.intel.com/intel/other/ehs/product_ecology/Recycling_Program.htm

Español

Como parte de su compromiso de responsabilidad medioambiental, Intel ha implantado el programa de reciclaje de productos Intel, que permite que los consumidores al detalle de los productos Intel devuelvan los productos usados en los lugares seleccionados para su correspondiente reciclado.

Consulte la http://www.intel.com/intel/other/ehs/product_ecology/Recycling_Program.htm para ver los detalles del programa, que incluye los productos que abarca, los lugares disponibles, instrucciones de envío, términos y condiciones, etc.

Français

Dans le cadre de son engagement pour la protection de l'environnement, Intel a mis en œuvre le programme Intel Product Recycling Program (Programme de recyclage des produits Intel) pour permettre aux consommateurs de produits Intel de recycler les produits usés en les retournant à des adresses spécifiées.

Visitez la page Web http://www.intel.com/intel/other/ehs/product_ecology/Recycling_Program.htm pour en savoir plus sur ce programme, à savoir les produits concernés, les adresses disponibles, les instructions d'expédition, les conditions générales, etc.

日本語

インテルでは、環境保護活動の一環として、使い終わったインテルブランド製品を指定の場所へ返送していただき、リサイクルを適切に行えるよう、インテル製品リサイクルプログラムを発足させました。

対象製品、返送先、返送方法、ご利用規約など、このプログラムの詳細情報は、http://www.intel.com/intel/other/ehs/product_ecology/Recycling_Program.htm (英語)をご覧ください。

Malay

Sebagai sebahagian daripada komitmennya terhadap tanggungjawab persekitaran, Intel telah melaksanakan Program Kitar Semula Produk untuk membenarkan pengguna-pengguna runcit produk jenama Intel memulangkan produk terguna ke lokasi-lokasi terpilih untuk dikitarkan semula dengan betul.

Sila rujuk http://www.intel.com/intel/other/ehs/product_ecology/Recycling_Program.htm untuk mendapatkan butir-butir program ini, termasuklah skop produk yang dirangkumi, lokasi-lokasi tersedia, arahan penghantaran, terma & syarat, dsb.

Portuguese

Como parte deste compromisso com o respeito ao ambiente, a Intel implementou o Programa de Reciclagem de Produtos para que os consumidores finais possam enviar produtos Intel usados para locais selecionados, onde esses produtos são reciclados de maneira adequada.

Consulte o site http://www.intel.com/intel/other/ehs/product_ecology/Recycling_Program.htm (em Inglês) para obter os detalhes sobre este programa, inclusive o escopo dos produtos cobertos, os locais disponíveis, as instruções de envio, os termos e condições, etc.

Russian

В качестве части своих обязательств к окружающей среде, в Intel создана программа утилизации продукции Intel (Product Recycling Program) для предоставления конечным пользователям марок продукции Intel возможности возврата используемой продукции в специализированные пункты для должной утилизации.

Пожалуйста, обратитесь на веб-сайт http://www.intel.com/intel/other/ehs/product_ecology/Recycling_Program.htm за информацией об этой программе, принимаемых продуктах, местах приема, инструкциях об отправке, положениях и условиях и т.д.

Türkçe

Intel, çevre sorumluluğuna bağlılığının bir parçası olarak, perakende tüketicilerin Intel markalı kullanılmış ürünlerini belirlenmiş merkezlere iade edip uygun şekilde geri dönüştürmesini amaçlayan Intel Ürünleri Geri Dönüşüm Programı'nı uygulamaya koymuştur.

Bu programın ürün kapsamı, ürün iade merkezleri, nakliye talimatları, kayıtlar ve şartlar v.s dahil bütün ayrıntılarını öğrenmek için lütfen

http://www.intel.com/intel/other/ehs/product_ecology/Recycling_Program.htm web sayfasına gidin.

Lead-Free Desktop Board

This desktop board is lead free although certain discrete components used on the board contain a small amount of lead which is necessary for component performance and/or reliability. This desktop board is referred to as “Lead-free second level interconnect.” The board substrate and the solder connections from the board to the components (second-level connections) are all lead free. Table 14 shows the various forms of the “Lead-Free 2nd Level Interconnect” mark as it appears on the board and accompanying collateral.

Table 14. Lead-Free Board Markings

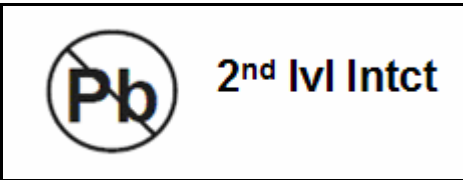
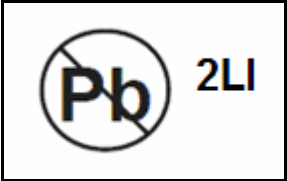
Description	Mark
<p>Lead-Free 2nd Level Interconnect: This symbol is used to identify electrical and electronic assemblies and components in which the lead (Pb) concentration level in the desktop board substrate and the solder connections from the board to the components (second-level interconnect) is not greater than 0.1% by weight (1000 ppm).</p>	<div style="text-align: center;">  <p>or</p>  <p>or</p>  </div>

EMC Regulations

Desktop Board D865GSA complies with the EMC regulations stated in Table 15 when correctly installed in a compatible chassis.

Table 15. EMC Regulations

Regulation	Title
FCC Class B	Title 47 of the Code of Federal Regulations, Parts 2 and 15, Subpart B, Radio Frequency Devices. (USA)
ICES-003 (Class B)	Interference-Causing Equipment Standard, Digital Apparatus. (Canada)
EN55022: 1998 (Class B)	Limits and methods of measurement of Radio Interference Characteristics of Information Technology Equipment. (European Union)
EN55024: 1998	Information Technology Equipment – Immunity Characteristics Limits and methods of measurement. (European Union)
AS/NZS CISPR22 (Class B)	Australian Communications Authority, Standard for Electromagnetic Compatibility. (Australia and New Zealand)
CISPR 22, 3 rd Edition, (Class B)	Limits and methods of measurement of Radio Disturbance Characteristics of Information Technology Equipment. (International)
CISPR 24: 1997	Information Technology Equipment – Immunity Characteristics – Limits and Methods of Measurement. (International)
VCCI (Class B)	Voluntary Control for Interference by Information Technology Equipment (Japan)

Japanese Kanji statement translation: This is a Class B product based on the standard of the Voluntary Control Council for Interference from Information Technology Equipment (VCCI). If this is used near a radio or television receiver in a domestic environment, it may cause radio interference. Install and use the equipment according to the instruction manual.

この装置は、情報処理装置等電波障害自主規制協議会（VCCI）の基準に基づくクラスB情報技術装置です。この装置は、家庭環境で使用することを目的としていますが、この装置がラジオやテレビジョン受信機に近接して使用されると、受信障害を引き起こすことがあります。
取扱説明書に従って正しい取り扱いをして下さい。

Korean Class B statement translation: This is household equipment that is certified to comply with EMC requirements. You may use this equipment in residential environments and other non-residential environments.

이 기기는 가정용으로 전자파적합등록을 한 기기로서 주거지역에서는 물론 모든 지역에서 사용할 수 있습니다.

Ensure Electromagnetic Compatibility (EMC) Compliance

Before computer integration, make sure that the power supply and other modules or peripherals, as applicable, have passed Class B EMC testing and are marked accordingly.

Pay close attention to the following when reading the installation instructions for the host chassis, power supply, and other modules:

- Product certifications or lack of certifications
- External I/O cable shielding and filtering
- Mounting, grounding, and bonding requirements
- Keying connectors when mating the wrong connectors could be hazardous









If the power supply and other modules or peripherals, as applicable, are not Class B EMC compliant before integration, then EMC testing may be required on a representative sample of the newly completed computer.

Product Certifications

Board-Level Certification Markings

Desktop Board D865GSA has the following product certification markings:

Table 16. Product Certification Markings

Description	Mark
UL joint US/Canada Recognized Component mark. Includes adjacent UL file number for Intel desktop boards: E210882.	
FCC Declaration of Conformity logo mark for Class B equipment. Includes Intel name and D865GSA model designation.	
CE mark. Declaring compliance to European Union (EU) EMC directive (89/336/EEC) and Low Voltage directive (73/23/EEC).	
Australian Communications Authority (ACA) C-tick mark. Includes adjacent Intel supplier code number, N-232.	
Japan VCCI (Voluntary Control Council for Interference) mark.	
S. Korea MIC (Ministry of Information and Communication) mark. Includes adjacent MIC certification number: CPU-D865GSA. For information about MIC certification, go to: http://support.intel.com/support/motherboards/desktop/	
Taiwan BSMI (Bureau of Standards, Metrology and Inspections) mark. Includes adjacent Intel company number, D33025.	
Printed wiring board manufacturer's recognition mark. Consists of a unique UL recognized manufacturer's logo, along with a flammability rating (solder side).	

Chassis and Component Certifications

Ensure that the chassis and certain components; such as the power supply, peripheral drives, wiring, and cables; are components certified for the country or market where used. Agency certification marks on the product are proof of certification. Typical product certifications include:

In Europe

The CE marking signifies compliance with all applicable European requirements. If the chassis and other components are not properly CE marked, a supplier's Declaration of Conformity statement to the European EMC directive and Low Voltage directive (as applicable), should be obtained. Additionally, other directives, such as the Radio and Telecommunications Terminal Equipment (R&TTE) directive may also apply depending on product features.

In the United States

A certification mark by a Nationally Recognized Testing Laboratory (NRTL) such as UL, CSA, or ETL signifies compliance with safety requirements. Wiring and cables must also be UL listed or recognized and suitable for the intended use. The FCC Class B logo for home or office use signifies compliance with electromagnetic interference (EMI) requirements.

In Canada

A nationally recognized certification mark such as CSA or cUL signifies compliance with safety requirements. The Industry Canada statement at the front of this product guide demonstrates compliance with Canadian EMC regulations.