

Intel® Desktop Board D955XBK Product Guide

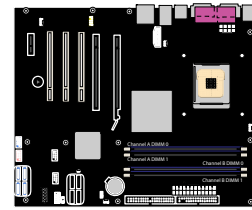

Order Number: C98666-002

Revision History

Revision	Revision History	Date
-001	First version of the Intel® Desktop Board D955XBK Product Guide	March 2005
-002	Second version of the Intel® Desktop Board D955XBK Product Guide	July 2005

If an FCC declaration of conformity marking is present on the board, the following statement applies:

FCC Declaration of Conformity

This device complies with Part 15 of the FCC Rules. Operation is subject to the following two conditions: (1) this device may not cause harmful interference, and (2) this device must accept any interference received, including interference that may cause undesired operation.

For questions related to the EMC performance of this product, contact:

Intel Corporation
5200 N.E. Elam Young Parkway
Hillsboro, OR 97124
1-800-628-8686

This equipment has been tested and found to comply with the limits for a Class B digital device, pursuant to Part 15 of the FCC Rules. These limits are designed to provide reasonable protection against harmful interference in a residential installation. This equipment generates, uses, and can radiate radio frequency energy and, if not installed and used in accordance with the instructions, may cause harmful interference to radio communications. However, there is no guarantee that interference will not occur in a particular installation. If this equipment does cause harmful interference to radio or television reception, which can be determined by turning the equipment off and on, the user is encouraged to try to correct the interference by one or more of the following measures:

Reorient or relocate the receiving antenna.

Increase the separation between the equipment and the receiver.

Connect the equipment to an outlet on a circuit other than the one to which the receiver is connected.

Consult the dealer or an experienced radio/TV technician for help.

Any changes or modifications to the equipment not expressly approved by Intel Corporation could void the user's authority to operate the equipment.

Tested to comply with FCC standards for home or office use.

Canadian Department of Communications Compliance Statement

This digital apparatus does not exceed the Class B limits for radio noise emissions from digital apparatus set out in the Radio Interference Regulations of the Canadian Department of Communications.

Le présent appareil numérique n'émet pas de bruits radioélectriques dépassant les limites applicables aux appareils numériques de la classe B prescrites dans le Règlement sur le brouillage radioélectrique édicté par le ministère des Communications du Canada.

Disclaimer

Information in this document is provided in connection with Intel® products. No license, express or implied, by estoppel or otherwise, to any intellectual property rights is granted by this document. Except as provided in Intel's Terms and Conditions of Sale for such products, Intel assumes no liability whatsoever, and Intel disclaims any express or implied warranty, relating to sale and/or use of Intel products including liability or warranties relating to fitness for a particular purpose, merchantability, or infringement of any patent, copyright or other intellectual property right. Intel products are not intended for use in medical, life saving, or life sustaining applications. Intel may make changes to specifications and product descriptions at any time, without notice.

Desktop Board D955XBK may contain design defects or errors known as errata which may cause the product to deviate from published specifications. Current characterized errata are available on request.

Contact your local Intel sales office or your distributor to obtain the latest specifications and before placing your product order.

Copies of documents which have an ordering number and are referenced in this document, or other Intel literature, may be obtained from Intel Corporation by going to the World Wide Web site at: <http://www.intel.com/> or by calling 1-800-548-4725.

Intel, Pentium, and Celeron are registered trademarks of Intel Corporation or its subsidiaries in the United States and other countries.

* Other names and brands may be claimed as the property of others.

Copyright © 2005, Intel Corporation. All rights reserved.

Preface

This Product Guide gives information about board layout, component installation, BIOS updates, and regulatory requirements for Intel® Desktop Board D955XBK.

Intended Audience

The Product Guide is intended only for technically qualified personnel.

Intended Uses

All Intel desktop boards are evaluated as Information Technology Equipment (I.T.E.) for use in personal computers (PC) for installation in homes, offices, schools, computer rooms, and similar locations. The suitability of this product for other PC or embedded non-PC applications or other environments, such as medical, industrial, alarm systems, test equipment, etc. may not be supported without further evaluation by Intel.

Information Layout

The chapters in this Product Guide are arranged as follows:

- [1 Desktop Board Features](#): a summary of product features.
- [2 Installing and Replacing Desktop Board Components](#): instructions on how to install the desktop board and other hardware components.
- [3 BIOS](#): information about how to update the BIOS.
- [4 Configuring for RAID \(Intel® Matrix Storage Technology\) Requires Microsoft Windows* XP or 2000 and SATA Hard Drive\(s\)](#): information about configuring your system for RAID.
- [A Error Messages and Indicators](#): information about BIOS error messages and beep codes.
- [B Regulatory Compliance](#): safety and EMC regulations, product certification.

Conventions

The following conventions are used in this manual:



CAUTION

Cautions warn the user about how to prevent damage to hardware or loss of data.



NOTE

Notes call attention to important information.

Terminology

The table below gives descriptions to some common terms used in the product guide.

Term	Description
GB	Gigabyte (1,073,741,824 bytes)
GHz	Gigahertz (one billion hertz)
KB	Kilobyte (1024 bytes)
MB	Megabyte (1,048,576 bytes)
Mbit	Megabit (1,048,576 bits)
MHz	Megahertz (one million hertz)

Box Contents

- Intel® Desktop Board
- I/O shield
- One ATA-66/100 cable
- One floppy cable
- Eight Serial ATA cables
- Two Serial ATA power cables
- One rear panel USB 2.0 adapter
- One front panel USB 2.0/IEEE 1394/audio adapter
- One 2x2 to 2x4 power adapter
- Intel® Express Installer driver CD-ROM
- Intel Express Installer software DVD-ROM
- Digital Home DVD
- Game flier
- Two floppy disk with RAID driver
- Back panel audio covers
- Quick Reference poster
- Integration Guide poster
- Printed Product Guide
- Configuration and battery caution statement label

Contents

1 Desktop Board Features

Supported Operating Systems	10
Desktop Board Components	11
Processor	13
Main Memory	13
Intel® 955X Express Chipset	14
Audio Subsystem	14
Input/Output (I/O) Controller	15
LAN Subsystem	15
LAN Subsystem Software	15
RJ-45 LAN Connector LEDs	16
Hi-Speed USB 2.0 Support	16
Enhanced IDE Interface	17
Serial ATA	17
Expandability	17
BIOS	17
Serial ATA and IDE Auto Configuration	17
PCI and PCI Express* Auto Configuration	18
Security Passwords	18
Chassis Intrusion	18
Power Management Features	18
ACPI	19
Fan Connectors	19
Fan Speed Control (Intel® Precision Cooling Technology)	19
Suspend to RAM (Instantly Available PC Technology)	19
Resume on Ring	20
Wake from USB	20
Wake from PS/2* Keyboard/Mouse	20
PME# Wakeup Support	20
Speaker	21
Battery	21
Real-Time Clock	21

2 Installing and Replacing Desktop Board Components

Before You Begin	23
Installation Precautions	24
Installation Instructions	24
Ensure Electromagnetic Compatibility (EMC) Compliance	24
Chassis and Component Certifications	25
Prevent Power Supply Overload	25
Place Battery Marking	25
Use Only for Intended Applications	26
Installing the I/O Shield	26
Installing and Removing the Desktop Board	27

Installing and Removing a Processor.....	28
Installing a Processor.....	28
Installing the Processor Fan Heat Sink.....	31
Connecting the Processor Fan Heat Sink Cable.....	31
Removing the Processor.....	31
Installing and Removing Memory.....	32
Installing DIMMs.....	34
Removing DIMMs.....	36
Installing and Removing a PCI Express x16 Card.....	36
Installing a PCI Express x16 Card.....	37
Removing the PCI Express x16 Card.....	38
Connecting the IDE Cable.....	39
Connecting the Serial ATA Cable.....	40
Connecting Internal Headers.....	41
Front Panel Audio Header.....	42
IEEE 1394a/b Headers.....	42
USB 2.0 Headers.....	43
Front Panel Header.....	43
Alternate Power LED Header.....	43
Installing the Rear Panel USB 2.0 Adapter.....	44
Installing the Front Panel USB/IEEE 1394/Audio Solution.....	45
Connecting Fans.....	46
Connecting Fans and Chassis Intrusion.....	46
Connecting the Auxiliary Power Output Connector.....	47
Connecting Power Cables.....	48
Other Connectors.....	50
Setting the BIOS Configuration Jumper.....	51
Clearing Passwords.....	52
Back Panel Connectors.....	53
Replacing the Battery.....	54
3 BIOS	
Updating the BIOS.....	59
Updating the BIOS with the Intel® Express BIOS Update Utility.....	59
Updating the BIOS with the Iflash Memory Update Utility.....	60
4 Configuring for RAID (Intel® Matrix Storage Technology) Requires Microsoft Windows* XP or 2000 and SATA Hard Drive(s)	
Configuring the BIOS for Intel Matrix Storage Technology.....	63
Creating Your RAID Set.....	63
Loading the Intel Matrix Storage Technology RAID Drivers and Software.....	63
Setting Up a “RAID Ready” System.....	64
A Error Messages and Indicators	
BIOS Beep Codes.....	65
BIOS Error Messages.....	65

B Regulatory Compliance

Safety Regulations	67
European Union Declaration of Conformity Statement	67
Product Ecology Statements	69
EMC Regulations	72
Product Certification Markings (Board Level).....	73

Figures

1. Desktop Board D955XBK Components.....	11
2. LAN Port LED Locations.....	16
3. Location of Standby Power Indicator.....	20
4. Installing the I/O Shield.....	26
5. Location of Mounting Screw Holes	27
6. Lift Socket Lever.....	28
7. Lift the Load Plate and Don't Touch the Socket Contacts	28
8. Remove the Protective Socket Cover.....	29
9. Remove the Processor from the Protective Processor Cover/Do Not Touch.....	29
10. Install the Processor	30
11. Close the Load Plate	30
12. Connecting the Processor Fan Heat Sink Cable to the Processor Fan Header.....	31
13. Dual Configuration Example 1.....	32
14. Dual Configuration Example 2.....	32
15. Dual Configuration Example 3.....	33
16. Use DDR2 DIMMs	34
17. Installing a DIMM.....	35
18. Slot to Use for One Video Card	37
19. Removing the PCI Express x16 Card.....	38
20. Connecting the IDE Cable	39
21. Connecting Serial ATA Cables	40
22. Internal Headers	41
23. Connecting the Rear Panel USB 2.0 Adapter	44
24. Connecting the Front Panel USB/IEEE 1394/Audio Cables.....	45
25. Location of Fan Headers	46
26. Auxiliary Power Output Connector	47
27. Connecting 2x10 Power Supply Cables	48
28. Connecting 2x12 Power Supply Cables	49
29. Location of Other Connectors.....	50
30. Location of the BIOS Configuration Jumper Block	51
31. Back Panel Connectors	53
32. Removing the Battery	57
33. F2 Key	59

Tables

1. Feature Summary.....	9
2. Desktop Board D955XBK Components.....	12
3. Power Supply Requirements	13
4. RJ-45 10/100/1000 Gigabit Ethernet LAN Connector LEDs.....	16
5. Front Panel Audio Header Signal Names.....	42
6. IEEE 1394b Header Signal Names	42
7. IEEE 1394a Header Signal Names	42
8. USB 2.0 Header Signal Names	43
9. Front Panel Header Signal Names.....	43
10. Jumper Settings for the BIOS Setup Program Modes.....	51
11. Beep Codes.....	65
12. BIOS Error Messages.....	65
13. Safety Regulations	67
14. Lead Free Desktop Board	71
15. EMC Regulations.....	72
16. Product Certification Markings.....	73

1 Desktop Board Features

This chapter briefly describes the main features of Intel® Desktop Board D955XBK. Table 1 summarizes the major features of the desktop board.

Table 1. Feature Summary

Form Factor	ATX (12.00" x 9.60")
Processor	Support for an Intel® processor in the LGA775 package with 1066/800 MHz front side bus
Main Memory	Four 240-pin SDRAM Dual Inline Memory Module (DIMM) sockets <ul style="list-style-type: none">• 667/533 MHz dual channel DDR2 SDRAM interface• Designed to support up to 8 GB of system memory
Chipset	Intel® 955X Express Chipset consisting of: <ul style="list-style-type: none">• Intel® 82955X Memory Controller Hub (MCH) with Direct Media Interface• Intel® 82801GR I/O Controller Hub (ICH7R) supporting Intel® Matrix Storage Technology
Audio	<ul style="list-style-type: none">• Intel 955X Express Chipset• Intel® High Definition Audio codec• Up to 8-channel audio with jack sensing
Expansion Capabilities	<ul style="list-style-type: none">• Up to three PCI bus add-in card connectors (SMBus routed to PCI bus connector 2)• One PCI Express x16 connector• One PCI Express x4 (routed to the physical x16 connector)• One PCI Express x1 connector
LAN Subsystem	Intel® 82573V or 82573L Gigabit Ethernet LAN controller with RJ-45 connector
BIOS	<ul style="list-style-type: none">• Intel® Platform Innovation Framework for Extensible Firmware Interface• 8 Mbit flash memory• Support for SMBIOS• Intel® Rapid BIOS Boot• Intel® Express BIOS Update
RAID	<ul style="list-style-type: none">• Intel® Matrix Storage Technology for Serial ATA• SATALink* for Serial ATA

continued

Table 1. Feature Summary (continued)

Peripheral Interfaces	<ul style="list-style-type: none"> • One front panel audio header (yellow) • Up to eight USB 2.0 ports <ul style="list-style-type: none"> — Four ports routed to the back panel — Four ports routed to two USB headers • Up to eight Serial ATA channels (one device per channel) <ul style="list-style-type: none"> — Four RAID capable Serial ATA (3.0 Gb/s) connectors (black) via the ICH7R — Four RAID capable Serial ATA (SATA) connectors (blue) via the discrete controller • Up to three IEEE 1394 ports: <ul style="list-style-type: none"> — One IEEE 1394a port routed to the back panel — One IEEE 1394a header (blue) — One IEEE 1394b header (pink) • One IDE interface with ATA-66/100 support • One diskette drive interface • One parallel port • One serial port • RJ-45 LAN port • PS/2* keyboard and mouse ports
Power Management	<ul style="list-style-type: none"> • Support for Advanced Configuration and Power Interface (ACPI) • Suspend to RAM (STR) • Wake on USB, PCI, PCI Express, PS/2, LAN, and front panel
Hardware Management	<p>Hardware monitor with:</p> <ul style="list-style-type: none"> • Four fan sensing inputs used to monitor fan activity • Remote diode temperature sensing • Intel® Precision Cooling Technology fan speed control • Voltage sensing to detect out of range values

Related Links

For more information about Intel Desktop Board D955XBK, including the Technical Product Specification (TPS), BIOS updates, and device drivers, go to:

<http://support.intel.com/support/motherboards/desktop/>

Supported Operating Systems

The desktop board supports the following operating systems:

- Microsoft Windows* XP Professional
- Microsoft Windows XP Home
- Microsoft Windows XP Media Center Edition 2005
- Microsoft Windows 2000

Desktop Board Components

Figure 1 shows the approximate location of the major components on Desktop Board D955XBK.

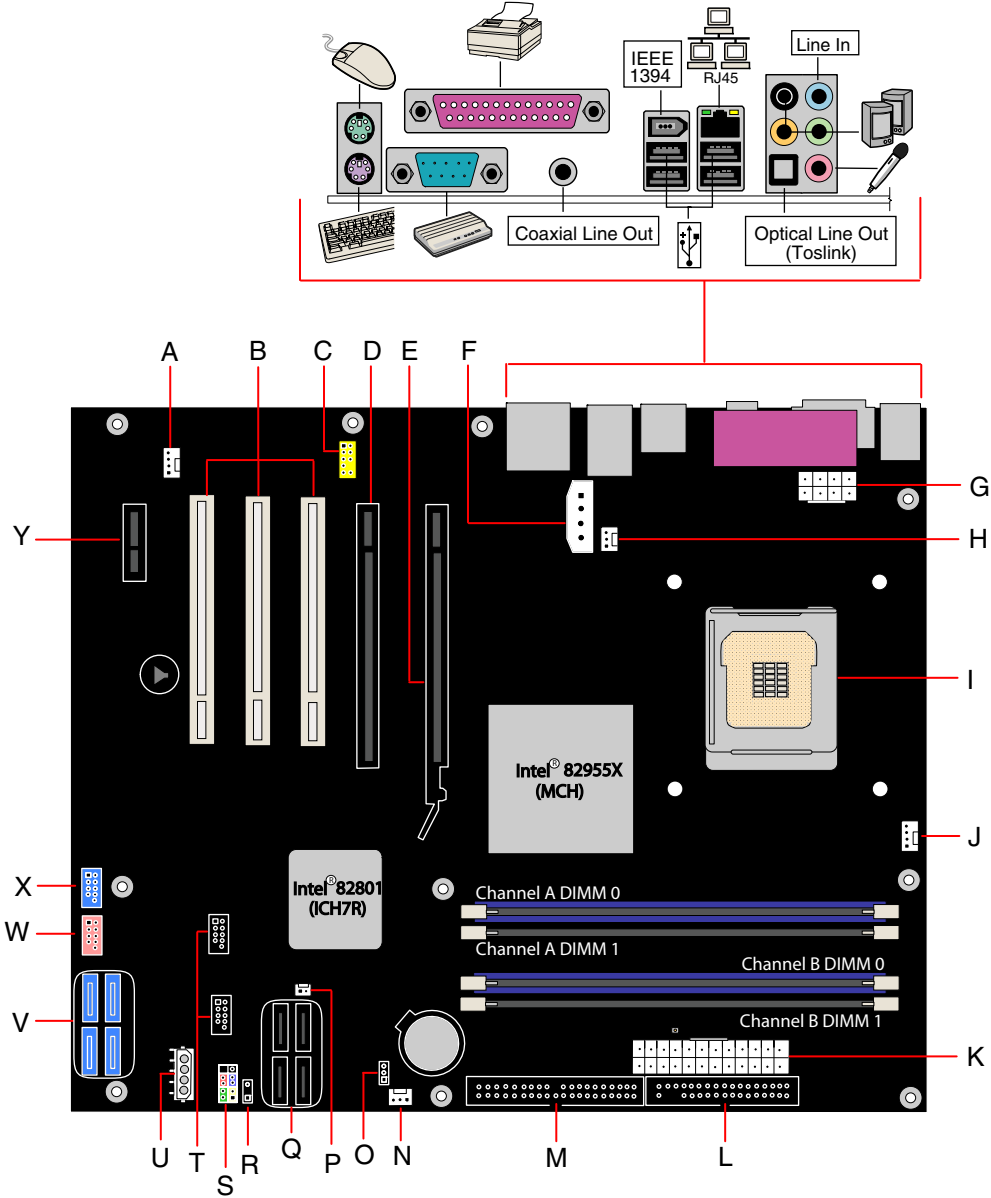

OM17592

Figure 1. Desktop Board D955XBK Components

Table 2. Desktop Board D955XBK Components

Label	Description
A	Auxiliary rear chassis fan header (4-pin, fan speed control)
B	PCI bus add-in card connectors (three)
C	Front panel audio header (yellow)
D	PCI Express x4 connector (routed to a physical x16 connector)
E	PCI Express x16 connector
F	Alternate power connector (1x4)
G	12 V power connector (2x4)
H	Rear chassis fan header (fan speed control)
I	Processor socket (LGA775)
J	Processor fan header (4-pin, fan speed control)
K	Main power connector (2x12)
L	Diskette drive connector
M	IDE connector
N	Front chassis fan header (fan speed control)
O	BIOS configuration jumper
P	Chassis intrusion header
Q	Serial ATA connectors (four, black)
R	Alternate power LED header
S	Front panel header
T	USB 2.0 headers (two)
U	Auxiliary power output header
V	Serial ATA connectors (four, blue)
W	IEEE 1394b header (pink)
X	IEEE 1394a header (blue)
Y	PCI Express x1 connector

Related Links

Go to the following links for more information about:

- Intel Desktop Board D955XBK <http://www.intel.com/design/motherbd>
<http://support.intel.com/support/motherboards/desktop>
- Supported processors <http://support.intel.com/support/motherboards/desktop>
- Audio software and utilities <http://www.intel.com/design/motherbd>
- LAN software and drivers <http://www.intel.com/design/motherbd>

Processor



CAUTION

Failure to use the appropriate power supply (below) and/or not connecting the 12 V (2x4) power connector to the desktop board may result in damage to the board or the system may not function properly.

Table 3. Power Supply Requirements

Platform Compatibility Guide	Power Supply Requirements
05B	12V2 rating of 16 A continuous and 19 A peak current for 10mS
05A	12V2 rating of 13 A continuous and 16.5 A peak current for 10mS
04B or 04A	ATX12V (version 2.0 or greater) compliant Power Supply

The desktop board D955XBK supports an Intel® processor in the LGA775 package. Processors are not included with the desktop board and must be purchased separately. The processor connects to the Intel desktop board through the LGA775 socket. The supported processors list for Desktop Board D955XBK is located on the web at:

<http://support.intel.com/support/motherboards/desktop/>

Related Links

Go to the following links or pages for more information about:

- Instructions on installing or upgrading the processor, page 28 in Chapter 2
- The location of the power connectors, page 48 in Chapter 2

Main Memory



NOTE

To be fully compliant with all applicable Intel® SDRAM memory specifications, the desktop board should be populated with DIMMs that support the Serial Presence Detect (SPD) data structure. If your memory modules do not support SPD, you will see a notification to this effect on the screen at power up. The BIOS will attempt to configure the memory controller for normal operation.

The desktop board supports dual or single channel memory configurations defined below:

- Four 240-pin Double Data Rate 2 (DDR2) SDRAM Dual Inline Memory Module (DIMMs) connectors with gold-plated contacts.
- Support for:
 - Unbuffered, non-registered single or double-sided DIMMs
 - ECC and non-ECC DDR2 667/533
 - Serial Presence Detect (SPD) memory only
 - Memory configuration listed below:
 - Up to 2.0 GB utilizing 256 Mb technology
 - Up to 4.0 GB utilizing 512 Mb or 1 Gb technology
 - Up to 8.0 GB utilizing 1 Gb technology

Related Links

Go to the following links or pages for more information about:

- The latest list of tested memory, <http://support.intel.com/support/motherboards/desktop/>
- SDRAM specifications, <http://www.intel.com/technology/memory/>
- Installing memory, page 32 in Chapter 2

Intel® 955X Express Chipset

The Intel 955X Express Chipset consists of the following devices:

- Intel 82955X Memory Controller Hub (MCH) with Direct Media Interface
- Intel 82801GR I/O Controller Hub (ICH7R)

Related Link

Go to the following link for more information about the Intel 955X Express Chipset:

<http://developer.intel.com/design/nav/pcserver.htm>

Audio Subsystem

The desktop board D955XBK includes a flexible 8-channel audio subsystem based on an Intel High Definition Audio codec:

The audio subsystem features:

- Impedance sensing capability for jack re-tasking
- S/N (signal-to-noise) ratio: > 90 dB
- Power management support for ACPI 2.0 (driver dependent)
- Intel 82801GR I/O Controller Hub (ICH7R)
- SigmaTel audio codec
- Microphone input that supports:
 - Microphone array
 - Acoustic Echo (AEC)
 - Beam Forming (BF)
 - Noise Suppression (NX) technology

The subsystem includes the following connectors:

- Front panel audio connector, including pins for:
 - Line out
 - Mic
- Back panel audio connectors that are configurable through the drivers of the audio devices:
 - Line in
 - Three Line out
 - Mic in or Center LFE out
 - Two digital Line out:
 - One coaxial Line out
 - One optical (Toslink) Line out

Related Links

Go to the following link or pages for more information about:

- Audio drivers and utilities <http://support.intel.com/support/motherboards/desktop/>
- Installing the front panel audio solution, page 45 in Chapter 2

Input/Output (I/O) Controller

The super I/O controller features the following:

- One serial port
- One parallel port with Extended Capabilities Port (ECP) and Enhanced Parallel Port (EPP) support
- Serial IRQ interface compatible with serialized IRQ support for PCI systems
- PS/2-style mouse and keyboard interfaces
- Interface for one 1.2 MB, 1.44 MB, or 2.88 MB diskette drive
- Intelligent power management, including a programmable wake up event interface
- PCI power management support

LAN Subsystem

The LAN, with the Intel 82801FR, provides a Fast PCI LAN subsystem. The LAN subsystem provides the following functions:

- Intel 82573V or 82573L Ethernet LAN supporting 10/100/1000 Mbit/sec
- Support for RJ-45 connector with status indicator LEDs
- Configurable EEPROM that contains the MAC address

LAN Subsystem Software

For LAN software and drivers, refer to the D955XBK link on Intel's World Wide Web site at:

<http://support.intel.com/support/motherboards/desktop>

RJ-45 LAN Connector LEDs

Two LEDs are built into the RJ-45 LAN port located on the back panel (see Figure 2).

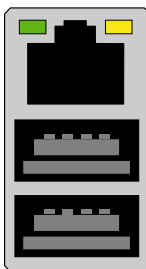

OM17386

Figure 2. LAN Port LED Locations

Table 4 describes the LED states when the board is powered up and the 10/100/1000 Gigabit Ethernet LAN subsystem is operating.

Table 4. RJ-45 10/100/1000 Gigabit Ethernet LAN Connector LEDs

LED	LED Color	LED State	Indicates
Left	Green	Off	LAN link is not established
		On	LAN link is established
		Blinking	LAN activity is occurring
Right	N/A	Off	10 Mb/s data rate
	Green	On	100 Mb/s data rate
	Yellow	On	1000 Mb/s data rate

Hi-Speed USB 2.0 Support



NOTE

Computer systems that have an unshielded cable attached to a USB port might not meet FCC Class B requirements, even if no device or a low-speed USB device is attached to the cable. Use a shielded cable that meets the requirements for a full-speed USB device.

The desktop board supports up to eight USB 2.0 ports via ICH7R; four ports routed to the back panel and four routed to two internal USB 2.0 headers. USB 2.0 ports are backward compatible with USB 1.1 devices. USB 1.1 devices will function normally at USB 1.1 speeds.

USB 2.0 support requires both an operating system and drivers that fully support USB 2.0 transfer rates. Disabling Hi-Speed USB in the BIOS reverts all USB 2.0 ports to USB 1.1 operation. This may be required to accommodate operating systems that do not support USB 2.0.

Enhanced IDE Interface

The ICH7R's IDE interface handles the exchange of information between the processor and peripheral devices like hard disks, CD-ROM drives, and Iomega Zip* drives inside the computer. The interface supports:

- Up to two IDE devices (such as hard drives)
- ATAPI-style devices (such as CD-ROM drives)
- Older PIO Mode devices
- Ultra DMA-33 and ATA-66/100 protocols
- Laser Servo (LS-120) drives

Serial ATA

The desktop board supports eight Serial ATA channels via the ICH7R, connecting one device per channel in either a RAID or non-RAID configuration.

Expandability

The desktop board supports the following:

- One PCI Express x16 add-in card
- One PCI Express x4 add-in card (routed to the physical x16 connector)
- One PCI Express x1 add-in card
- Three PCI bus add-in cards

Related Links

For information about installing the PCI Express x16 card, see page 36 in Chapter 2.

BIOS

The BIOS provides the Power-On Self-Test (POST), the BIOS Setup program, the PCI and IDE auto-configuration utilities, and the video BIOS.

See Chapter 3 on page 59 for more information about the BIOS.

Serial ATA and IDE Auto Configuration

If you install a Serial ATA or IDE device (such as a hard drive) in your desktop board, the auto-configuration utility in the BIOS automatically detects and configures the device for your computer. You do not need to run the BIOS Setup program after installing a Serial ATA or IDE device. You can override the auto-configuration options by specifying manual configuration in the BIOS Setup program.

When booting from a Serial ATA device, Serial ATA connector 0 is the first boot device and Serial ATA connector 3 is the last boot device by default.

PCI and PCI Express* Auto Configuration

If you install a PCI/PCI Express add-in card in your desktop board, the PCI/PCI Express auto-configuration utility in the BIOS automatically detects and configures the resources (IRQs, DMA channels, and I/O space) for that add-in card. You do not need to run the BIOS Setup program after you install a PCI/PCI Express add-in card.

Security Passwords

The BIOS includes security features that restrict whether the BIOS Setup program can be accessed and who can boot the computer. A supervisor password and a user password can be set for the BIOS Setup and for booting the computer, with the following restrictions:

- The supervisor password gives unrestricted access to view and change all Setup options. If only the supervisor password is set, pressing <Enter> at the password prompt of Setup gives the user restricted access to Setup.
- If both the supervisor and user passwords are set, you must enter either the supervisor password or the user password to access Setup. Setup options are then available for viewing and changing depending on whether the supervisor or user password was entered.
- Setting a user password restricts who can boot the computer. The password prompt is displayed before the computer is booted. If only the supervisor password is set, the computer boots without asking for a password. If both passwords are set, you can enter either password to boot the computer.

Related Links:

For instructions on resetting the password, see Clearing Passwords on page 52.

Chassis Intrusion

The desktop board supports a chassis security feature that detects if the chassis cover has been removed. The security feature uses a mechanical switch on the chassis that can be connected to the chassis intrusion header on the desktop board. See Figure 25 on page 46 for the location of the chassis intrusion header.

Power Management Features

Power management is implemented at several levels, including:

- Advanced Configuration and Power Interface (ACPI)
- Hardware support:
 - Fan connectors
 - Suspend to RAM (Instantly Available PC technology)
 - Resume on Ring
 - Wake from USB
 - Wake from PS/2 keyboard/mouse
 - PME# wakeup support

ACPI

ACPI gives the operating system direct control over the power management and Plug and Play functions of a computer. The use of ACPI with the desktop board requires an operating system that provides full ACPI support.

Fan Connectors

Desktop Board D955XBK has three chassis fan headers (two 3-pin and one 4-pin) and one processor fan header (4-pin).

Fan Speed Control (Intel® Precision Cooling Technology)

Intel Precision Cooling Technology automatically adjusts the processor fan speed based on the processor temperature and adjusts the chassis fan speeds depending on the system temperature. System fan noise may be reduced by operating controlled chassis and processor fans at the minimum necessary speeds.

The processor and chassis fan speed control features can be disabled independently through the desktop board BIOS. Disabling the processor fan speed control will result in the fan operating at full speed if it is not a self controlled fan. It is recommended that processor fan speed control remain enabled (default BIOS setting) when using the processor fan heat-sink included with Intel® boxed processors. Disabling the chassis fan speed control results in chassis fans always operating at full speed. The chassis fan speed control feature should be disabled if a self-controlled chassis fan is attached to any controlled chassis fan header.

The overall system noise reduction will vary based on system configuration and environment.

Suspend to RAM (Instantly Available PC Technology)



CAUTION

For Instantly Available PC technology, the 5 V standby line for the power supply must be capable of delivering adequate +5 V standby current. Failure to provide adequate standby current when using this feature can damage the power supply and/or affect ACPI S3 sleep state functionality.



CAUTION

Power supplies used with this desktop board must be able to provide enough standby current to support the standard Instantly Available (ACPI S3 sleep state) configuration. If the standby current necessary to support multiple wake events from the PCI and/or USB buses exceeds power supply capacity, the desktop board may lose register settings stored in memory.

Instantly Available PC technology enables the board to enter the ACPI S3 (Suspend-to-RAM) sleep state. While in the S3 sleep state, the computer will appear to be off. When signaled by a wake-up device or event, the system quickly returns to its last known awake state.

The desktop board's standby power indicator, shown in Figure 3, is lit when there is standby power to the system. This includes the memory modules and PCI bus connectors, even when the computer appears to be off.

If the system has a dual-colored power LED on the front panel, the sleep state is indicated by the LED turning amber.

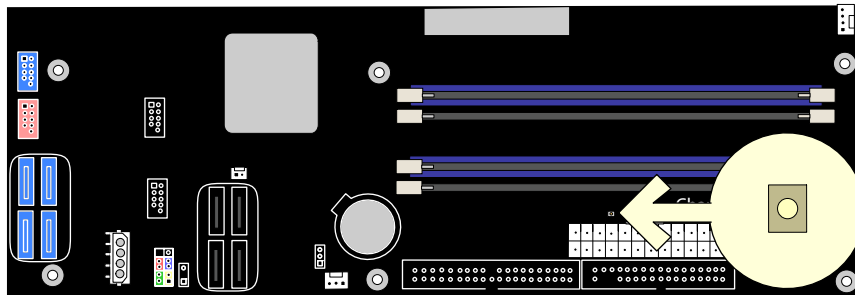

OM17610

Figure 3. Location of Standby Power Indicator

Related Links

For more information on standby current requirements for the desktop board, go to the link below, select the desktop board name, and then select Technical Documentation:

<http://developer.intel.com/design/motherbd/>

Resume on Ring

The operation of Resume on Ring can be summarized as follows:

- Resumes operation from either ACPI S1 or ACPI S3 state
- Requires only one call to access the computer
- Detects incoming call similarly for external and internal modems
- Requires modem interrupt be unmasked for correct operation

Wake from USB



NOTE

Wake from USB requires the use of a USB peripheral that supports Wake from USB.

USB bus activity wakes the computer from an ACPI S1 or S3 state.

Wake from PS/2* Keyboard/Mouse

PS/2 keyboard/mouse activity wakes the computer from an ACPI S1 or S3 state.

PME# Wakeup Support

When the PME# signal on the PCI bus is asserted, the computer wakes from an ACPI S1, S3, or S5 state.

Speaker

A speaker is mounted on the desktop board. The speaker provides audible error code (beep code) information during the Power-On Self-Test (POST).

Battery

A battery on the desktop board keeps the values in CMOS RAM and the clock current when the computer is turned off. See Chapter 2 starting on page 23 for instructions on how to replace the battery.

Real-Time Clock

The desktop board has a time-of-day clock and 100-year calendar. The battery on the desktop board keeps the clock current when the computer is turned off.

2 Installing and Replacing Desktop Board Components

This chapter tells you how to:

- Install the I/O shield
- Install and remove the desktop board
- Install and remove a processor and memory
- Install and remove a PCI Express x16 add-in card
- Connect the IDE and Serial ATA cables
- Connect internal headers
- Install the rear and front panel USB/IEEE 1394/audio solutions
- Connect fans and power cables
- Identify other connectors
- Set the BIOS configuration jumper
- Clear passwords
- Identify back panel connectors
- Replace the battery

Before You Begin



CAUTIONS

The procedures in this chapter assume familiarity with the general terminology associated with personal computers and with the safety practices and regulatory compliance required for using and modifying electronic equipment.

Disconnect the computer from its power source and from any telecommunications links, networks, or modems before performing any of the procedures described in this chapter. Failure to disconnect power, telecommunications links, networks, or modems before you open the computer or perform any procedures can result in personal injury or equipment damage. Some circuitry on the board can continue to operate even though the front panel power button is off.

Follow these guidelines before you begin:

- Always follow the steps in each procedure in the correct order.
- Set up a log to record information about your computer, such as model, serial numbers, installed options, and configuration information.
- Electrostatic discharge (ESD) can damage components. Perform the procedures described in this chapter only at an ESD workstation using an antistatic wrist strap and a conductive foam pad. If such a station is not available, you can provide some ESD protection by wearing an antistatic wrist strap and attaching it to a metal part of the computer chassis.

Installation Precautions

When you install and test the Intel desktop board, observe all warnings and cautions in the installation instructions.

To avoid injury, be careful of:

- Sharp pins on connectors
- Sharp pins on printed circuit assemblies
- Rough edges and sharp corners on the chassis
- Hot components (like processors, voltage regulators, and heat sinks)
- Damage to wires that could cause a short circuit

Observe all warnings and cautions that instruct you to refer computer servicing to qualified technical personnel.

Installation Instructions



CAUTION

Follow these guidelines to meet safety and regulatory requirements when installing this board.

Read and adhere to all of these instructions and the instructions supplied with the chassis and associated modules. If the instructions for the chassis are inconsistent with these instructions or the instructions for associated modules, contact the supplier's technical support to find out how you can ensure that your computer meets safety and regulatory requirements. If you do not follow these instructions and the instructions provided by chassis and module suppliers, you increase safety risk and the possibility of noncompliance with regional laws and regulations.

Ensure Electromagnetic Compatibility (EMC) Compliance

Before computer integration, make sure that the power supply and other modules or peripherals, as applicable, have passed Class B EMC testing and are marked accordingly.

Pay close attention to the following when reading the installation instructions for the host chassis, power supply, and other modules:

- Product certifications or lack of certifications
- External I/O cable shielding and filtering
- Mounting, grounding, and bonding requirements
- Keying connectors when mating the wrong connectors could be hazardous

If the power supply and other modules or peripherals, as applicable, are not Class B EMC compliant before integration, then EMC testing may be required on a representative sample of the newly completed computer.

Chassis and Component Certifications

Ensure that the chassis and certain components; such as the power supply, peripheral drives, wiring, and cables; are components certified for the country or market where used. Agency certification marks on the product are proof of certification. Typical product certifications include:

In Europe

The CE marking signifies compliance with all applicable European requirements. If the chassis and other components are not properly CE marked, a supplier's Declaration of Conformity statement to the European EMC directive and Low Voltage directive (as applicable), should be obtained. Additionally, other directives, such as the Radio and Telecommunications Terminal Equipment (R&TTE) directive may also apply depending on product features.

In the United States

A certification mark by a Nationally Recognized Testing Laboratory (NRTL) such as UL, CSA, or ETL signifies compliance with safety requirements. Wiring and cables must also be UL listed or recognized and suitable for the intended use. The FCC Class B logo for home or office use signifies compliance with electromagnetic interference (EMI) requirements.

In Canada

A nationally recognized certification mark such as CSA or cUL signifies compliance with safety requirements. The Industry Canada statement at the front of this product guide demonstrates compliance with Canadian EMC regulations.

Prevent Power Supply Overload

Do not overload the power supply output. To avoid overloading the power supply, make sure that the calculated total current loads of all the modules within the computer is less than the output current rating of each of the power supplies output circuits.

Place Battery Marking



CAUTION

Risk of explosion if the battery is replaced with an incorrect type. Batteries should be recycled where possible. Disposal of used batteries must be in accordance with local environmental regulations.

There is insufficient space on this desktop board to provide instructions for replacing and disposing of the Lithium ion coin cell battery. For system safety certification, the above statement or equivalent statement is required to be permanently and legibly marked on the chassis near the battery.

Related Links

For information about replacing the battery, go to page 53.

Use Only for Intended Applications

All Intel desktop boards are evaluated as Information Technology Equipment (I.T.E.) for use in personal computers (PC) for installation in homes, offices, schools, computer rooms, and similar locations. The suitability of this product for other PC or embedded non-PC applications or other environments, such as medical, industrial, alarm systems, test equipment, etc. may not be supported without further evaluation by Intel.

Related Links

For information about regulatory compliance, go to Appendix B on page 67.

Installing the I/O Shield

The desktop board comes with an I/O shield. When installed in the chassis, the shield blocks radio frequency transmissions, protects internal components from dust and foreign objects, and promotes correct airflow within the chassis.

Install the I/O shield before installing the desktop board in the chassis. Place the shield inside the chassis as shown in Figure 4. Press the shield into place so that it fits tightly and securely. If the shield doesn't fit, obtain a properly-sized shield from the chassis supplier.

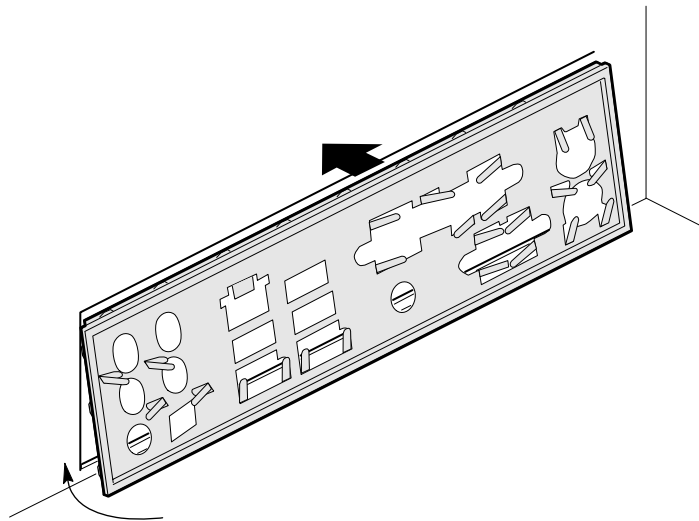

OM17594

Figure 4. Installing the I/O Shield

Installing and Removing the Desktop Board

WARNING

Only qualified technical personnel should do this procedure. Disconnect the computer from its power source before performing the procedures described here. Failure to disconnect the power before you open the computer can result in personal injury or equipment damage.



NOTE

Refer to Appendix B for regulatory requirements.

Refer to your chassis manual for instructions on installing and removing the desktop board. Figure 5 shows the location of the 10 mounting screw holes for Desktop Board D955XBK.

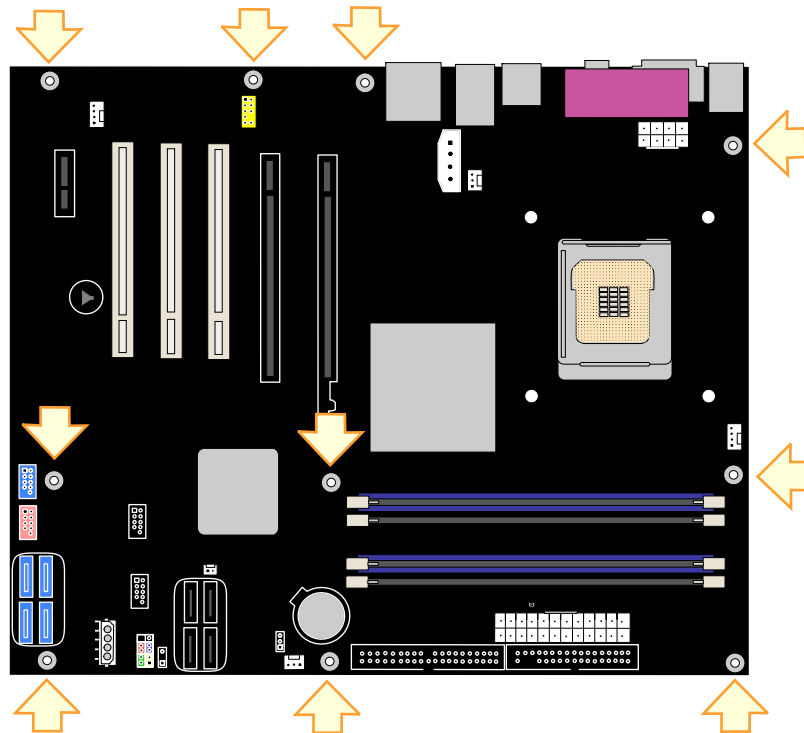

OM17595

Figure 5. Location of Mounting Screw Holes

Installing and Removing a Processor

Instructions on how to install the processor to the desktop board are given below.

Installing a Processor



CAUTION

Before installing or removing the processor, make sure that AC power has been removed by unplugging the power cord from the computer; the standby power LED should not be lit (see Figure 3 on page 20). Failure to do so could damage the processor and the board.

To install a processor, follow these instructions:

1. Observe the precautions in "Before You Begin" on page 23.
2. Open the socket lever by pushing the lever down and away from the socket (see Figure 6, A and B).

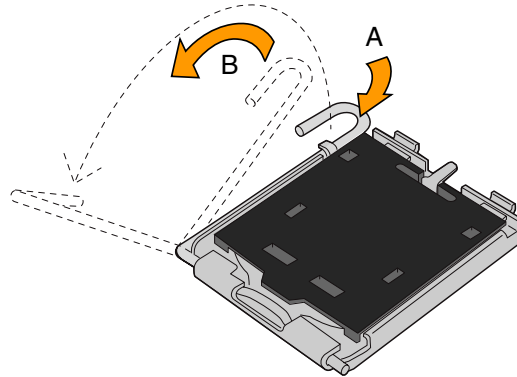

OM17210

Figure 6. Lift Socket Lever

3. Lift the load plate. Do not touch the socket contacts (see Figure 7, C and D).

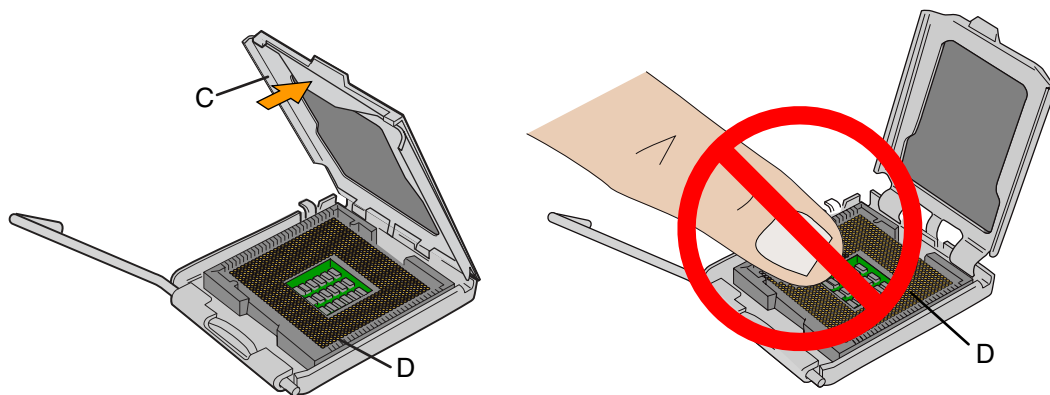

OM17211

Figure 7. Lift the Load Plate and Don't Touch the Socket Contacts

4. Remove the protective socket cover from the load plate. Do not discard the protective socket cover. Always replace the socket cover if the processor is removed from the socket (see Figure 8, E).

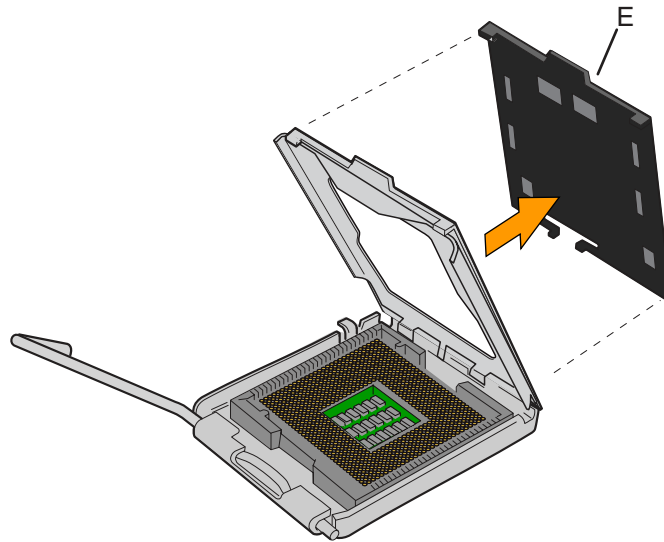

OM17228

Figure 8. Remove the Protective Socket Cover

5. Remove the processor from the protective processor cover. Hold the processor only at the edges, being careful not to touch the bottom of the processor (see Figure 9). Do not discard the protective processor cover. Always replace the processor cover if the processor is removed from the socket.

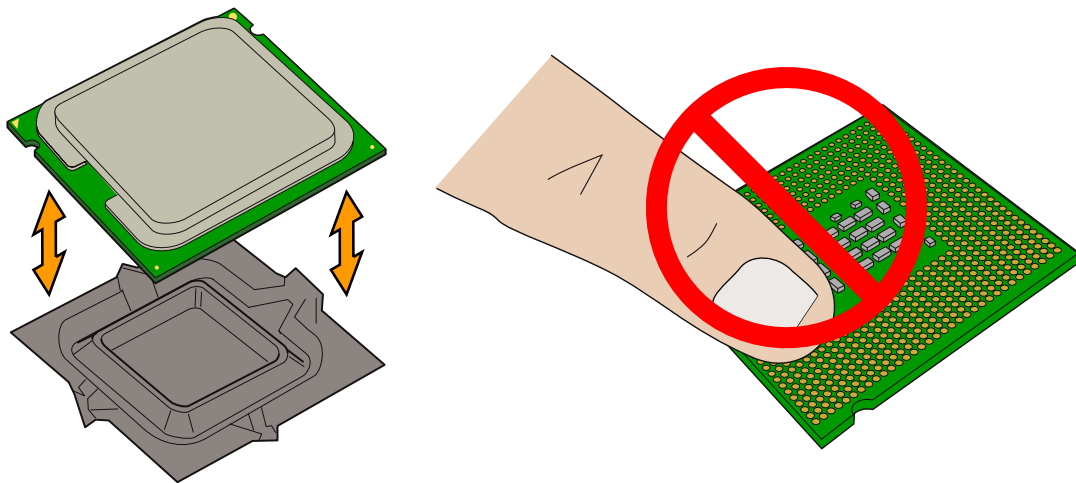

OM17213

Figure 9. Remove the Processor from the Protective Processor Cover/Do Not Touch

6. Hold the processor with your thumb and index fingers oriented as shown in Figure 10. Make sure fingers align to the socket cutouts (see Figure 10, F). Align notches (see Figure 10, G) with the socket see (Figure 10, H). Lower the processor straight down without tilting or sliding the processor in the socket.

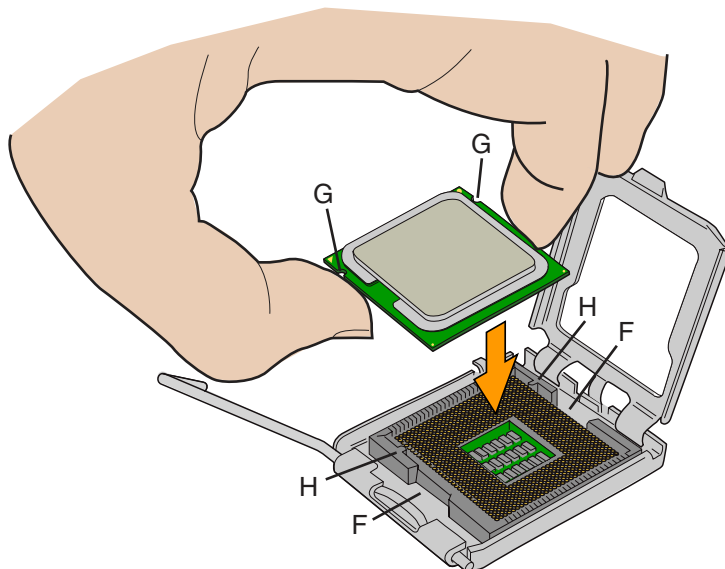

OM17214

Figure 10. Install the Processor

7. While pressing down on the load plate (Figure 11, I), close and engage the socket lever (Figure 11, J).

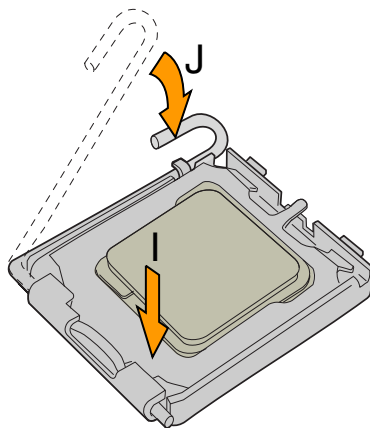

OM17215

Figure 11. Close the Load Plate

Installing the Processor Fan Heat Sink

Desktop Board D955XBK has an integrated processor fan heat sink retention mechanism (RM). For instructions on how to attach the processor fan heat sink to the integrated processor fan heat sink RM, refer to the boxed processor manual or the Intel World Wide Web site at:

<http://support.intel.com/support/processors/pentium4/intnotes478.htm>

Connecting the Processor Fan Heat Sink Cable

Connect the processor fan heat sink cable to the 4-pin processor fan header (see Figure 12).

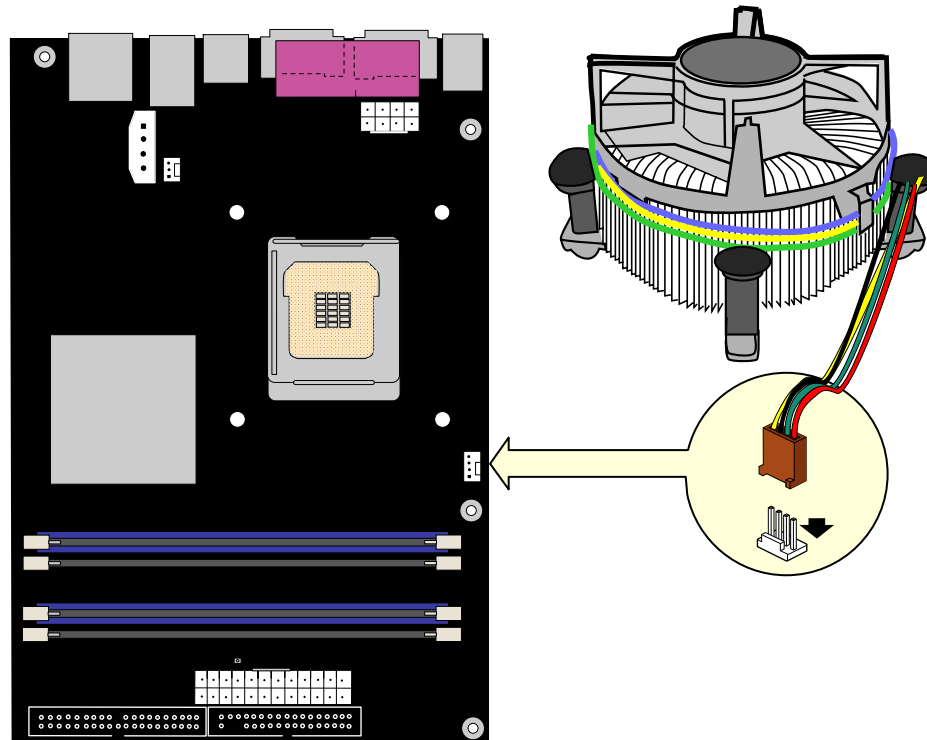

OM17596

Figure 12. Connecting the Processor Fan Heat Sink Cable to the Processor Fan Header

Removing the Processor

For instructions on how to remove the processor fan heat sink and processor, refer to the processor installation manual or the Intel World Wide Web site at:

<http://support.intel.com/support/processors/pentium4/intnotes478.htm>

Installing and Removing Memory



CAUTION

To be fully compliant with all applicable Intel SDRAM memory specifications, the board requires DIMMs that support the Serial Presence Detect (SPD) data structure. You can access the PC Serial Presence Detect Specification at:

<http://www.intel.com/technology/memory/pcsdram/spec/>

Desktop Board D955XBK has four 240-pin DIMM sockets arranged as DIMM 0 and DIMM 1 in both Channel A and Channel B, as shown in Figure 17.

Guidelines for Dual Channel Memory Configuration

Before installing DIMMs, read and follow these guidelines for dual channel configuration.

Two or Four DIMMs

Install a matched pair of DIMMs equal in speed and size (see Figure 13) in DIMM 0 (blue) of both channels A and B.

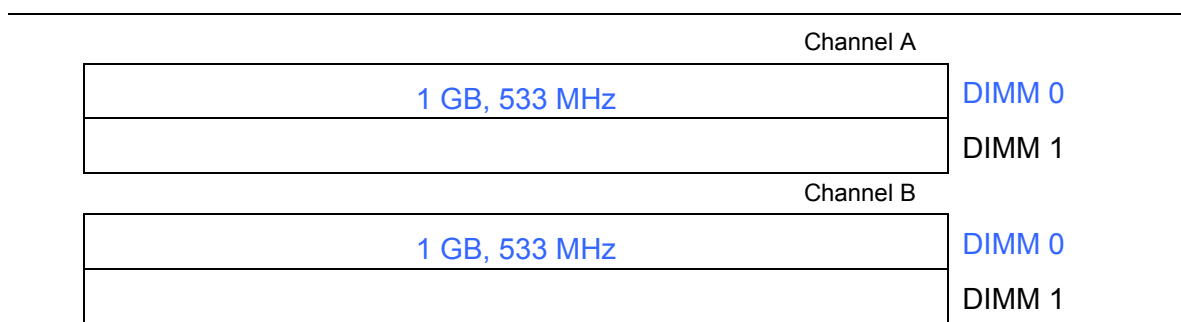

Figure 13. Dual Configuration Example 1

If additional memory is to be used, install another matched pair of DIMMs in DIMM 1 (black) in both channels A and B (see Figure 14).

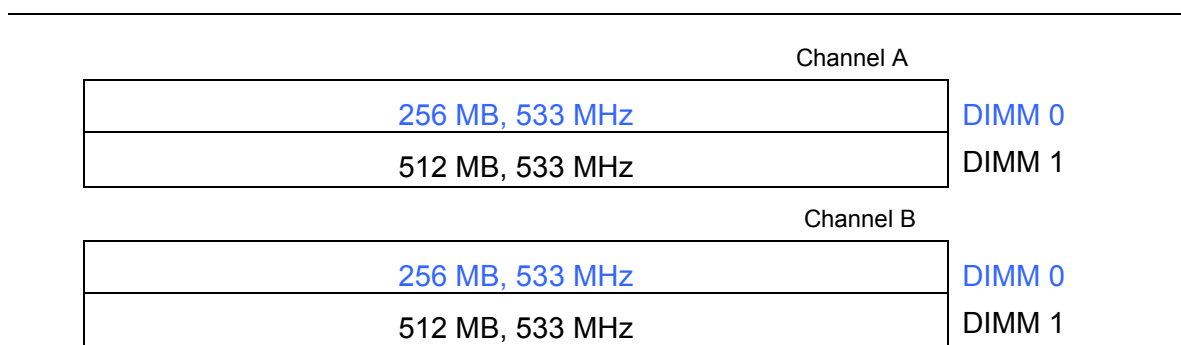

Figure 14. Dual Configuration Example 2

Three DIMMs

Install a matched pair of DIMMs equal in speed and size in DIMM 0 (blue) and DIMM 1 (black) of channel A. Install a DIMM equal in speed and total size of the DIMMs installed in channel A in either DIMM 0 or DIMM 1 of channel B (see Figure 15).

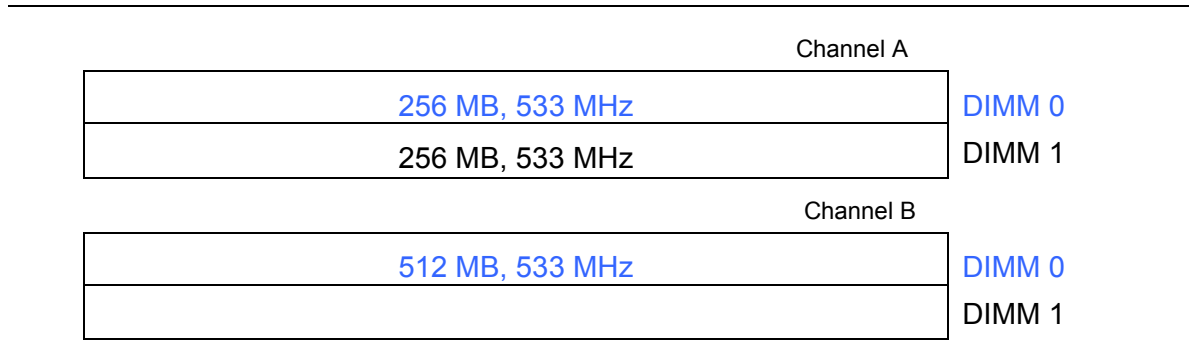

Figure 15. Dual Configuration Example 3



NOTE

All other memory configurations will result in single channel memory operation.

Installing DIMMs



CAUTION

Install memory in the DIMM sockets prior to installing the PCI Express x16 card to avoid interference with the memory retention mechanism.

To make sure you have the correct DIMM, place the DIMM on the illustration in Figure 16 showing the DDR2 DIMM. All the notches should match with the DDR2 DIMM.

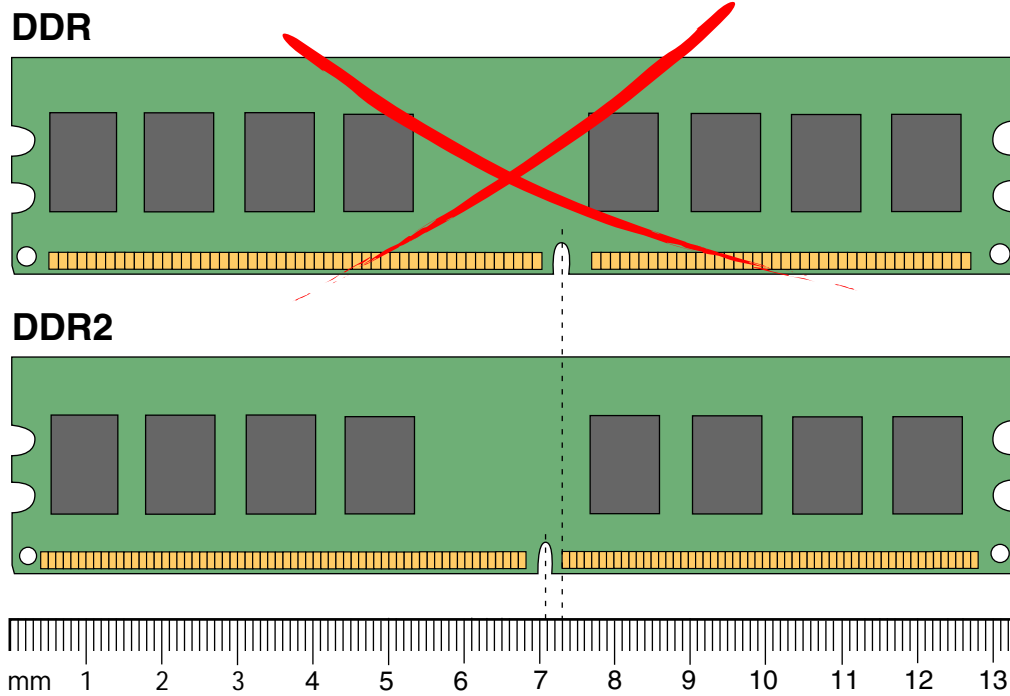

OM16943

Figure 16. Use DDR2 DIMMs

To install DIMMs, follow these steps:

1. Observe the precautions in "Before You Begin" on page 23.
2. Turn off all peripheral devices connected to the computer. Turn off the computer and disconnect the AC power cord.
3. Remove the computer's cover and locate the DIMM sockets (see Figure 17).
4. Remove the PCI Express card if it interferes with the DIMM retaining clips from being easily opened and closed.

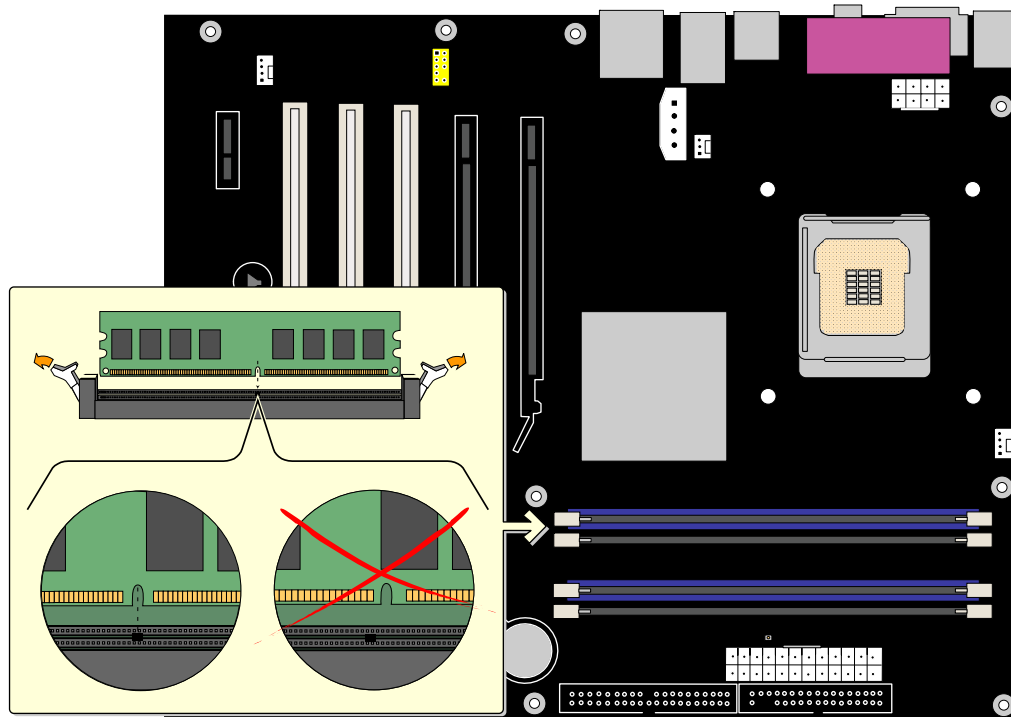

OM17597

Figure 17. Installing a DIMM

5. Make sure the clips at either end of the DIMM socket(s) are pushed outward to the open position.
6. Holding the DIMM by the edges, remove it from its anti-static package.
7. Position the DIMM above the socket. Align the small notch at the bottom edge of the DIMM with the keys in the socket (see inset in Figure 17).
8. Insert the bottom edge of the DIMM into the socket.
9. When the DIMM is inserted, push down on the top edge of the DIMM until the retaining clips snap into place. Make sure the clips are firmly in place.
10. Reinstall the PCI Express x16 card if it was removed prior to installing the DIMMs.
11. Replace the computer's cover and reconnect the AC power cord.

Removing DIMMs

To remove a memory module, follow these steps:

1. Observe the precautions in "Before You Begin" on page 23.
2. Turn off all peripheral devices connected to the computer. Turn off the computer.
3. Remove the AC power cord from the computer.
4. Remove the computer's cover.
5. Remove the PCI Express x16 card if it interferes with the DIMM clips from being easily opened and closed.
6. Gently spread the retaining clips at each end of the DIMM socket. The DIMM pops out of the socket.
7. Hold the DIMM by the edges, lift it away from the socket, and store it in an anti-static package.
8. Reinstall and reconnect any parts you removed or disconnected to reach the DIMM sockets.
9. Replace the computer's cover and reconnect the AC power cord.

Installing and Removing a PCI Express x16 Card



CAUTION

When installing any PCI Express x16 card on the desktop board, ensure that it is fully seated in the PCI Express x16 connector before you power on the system. If the card is not fully seated in the PCI Express x16 connector, an electrical short may result across the PCI Express x16 connector pins. Depending on the over-current protection of the power supply, certain board components and/or traces may be damaged.

The desktop board has an integrated PCI Express x16 card retention mechanism (RM).

Installing a PCI Express x16 Card

Use the PCI Express x16 slot indicated in Figure 18 if you are using only one video card. Follow these instructions to install a PCI Express x16 card:

1. Observe the precautions in "Before You Begin" on page 23.
2. Place the card in the PCI Express x16 connector.
3. Press down on the card until it is completely seated in the PCI Express x16 connector and the card retention notch snaps into place around the RM pin.
4. Secure the card's metal bracket to the chassis back panel with a screw.

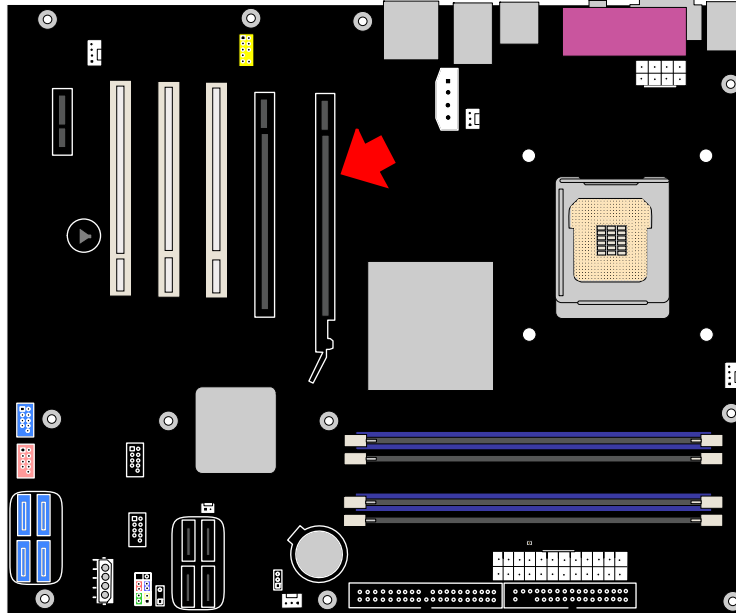

OM17717

Figure 18. Slot to Use for One Video Card

Removing the PCI Express x16 Card

Follow these instructions to remove the PCI Express x16 card from the RM:

1. Observe the precautions in "Before You Begin" on page 23.
2. Remove the screw that secures the card's metal bracket to the chassis back panel (Figure 19, A).
3. Push back on the RM lever until the retention pin completely clears the notch in the card (Figure 19, B).
4. Pull the card straight up (Figure 19, C).

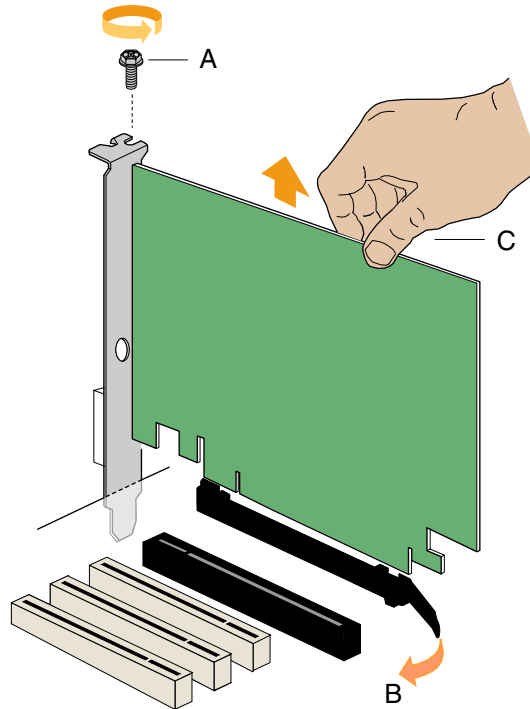

OM17716

Figure 19. Removing the PCI Express x16 Card

Connecting the IDE Cable

The IDE cable can connect two drives to the desktop board. The cable supports the ATA-66/100 transfer protocol. Figure 20 shows the correct installation of the cable.



NOTE

ATA-66/100 compatible cables are backward compatible with drives using slower IDE transfer protocols. If an ATA-66/100 disk drive and a disk drive using any other IDE transfer protocol are attached to the same cable, the maximum transfer rate between the drives may be reduced to that of the slowest drive.



NOTE

Do not connect an ATA device as a slave on the same IDE cable as an ATAPI master device. For example, do not connect an ATA hard drive as a slave to an ATAPI CD-ROM drive.

For correct function of the cable:

1. Observe the precautions in "Before You Begin" on page 23.
2. Attach the cable end with the single connector to the desktop board (Figure 20, A).
3. Attach the cable end with the two closely spaced connectors to the drives (Figure 20, B).

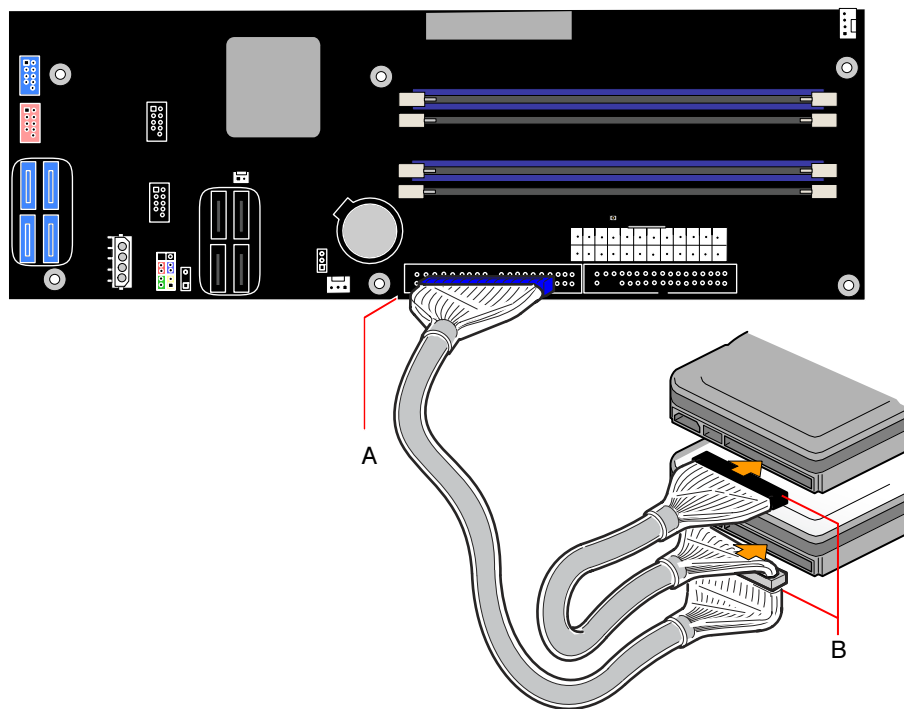

OM17598

Figure 20. Connecting the IDE Cable

Connecting the Serial ATA Cable

The SATA cable (4-conductor) supports the Serial ATA protocol and connects a single drive to the desktop board. Either end of the cable can be connected to the SATA drive or the connector on the board.

For correct cable function:

1. Observe the precaution in "Before You Begin" on page 23.
2. Attach the locking cable end to the connector (Figure 21, A) on the board.
3. Attach the cable end without the lock to the drive (Figure 21, B).

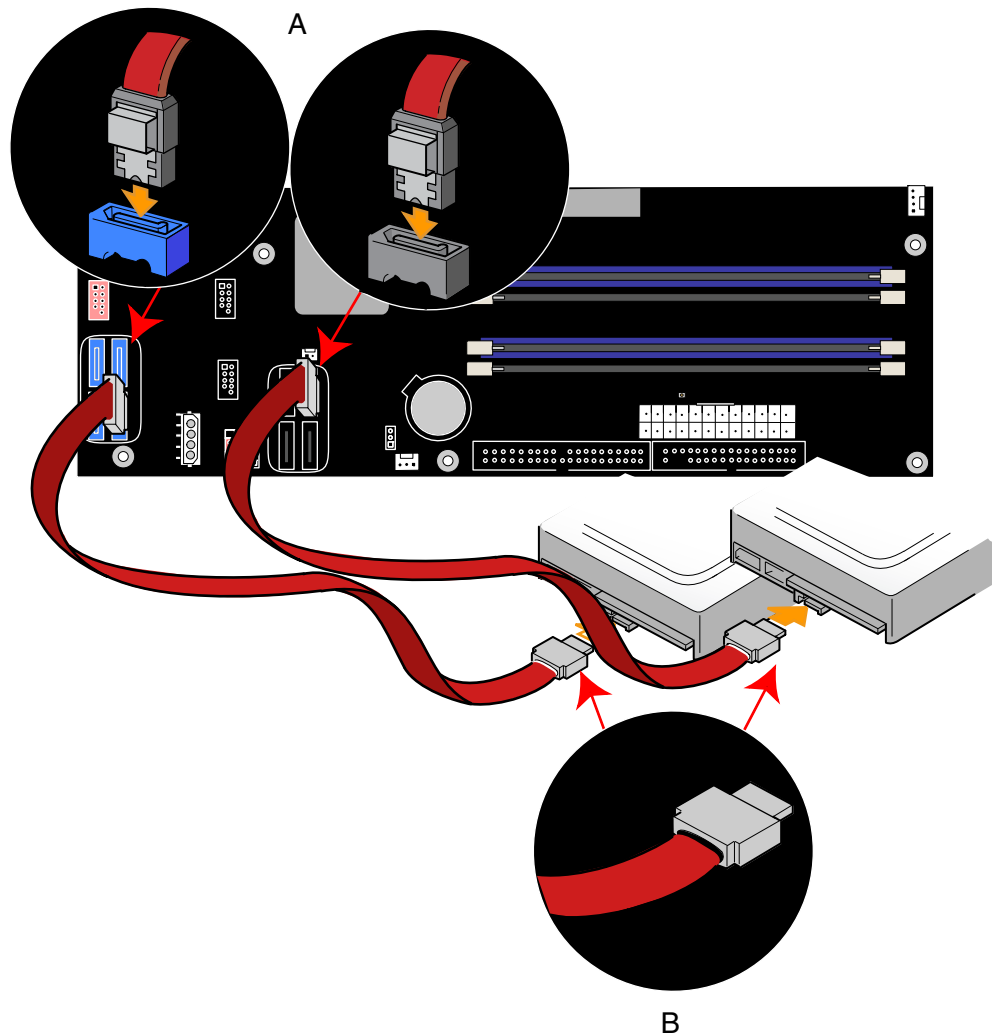

OM17599

Figure 21. Connecting Serial ATA Cables

Connecting Internal Headers

Before connecting cables to the internal headers, observe the precautions in "Before You Begin" on page 23.

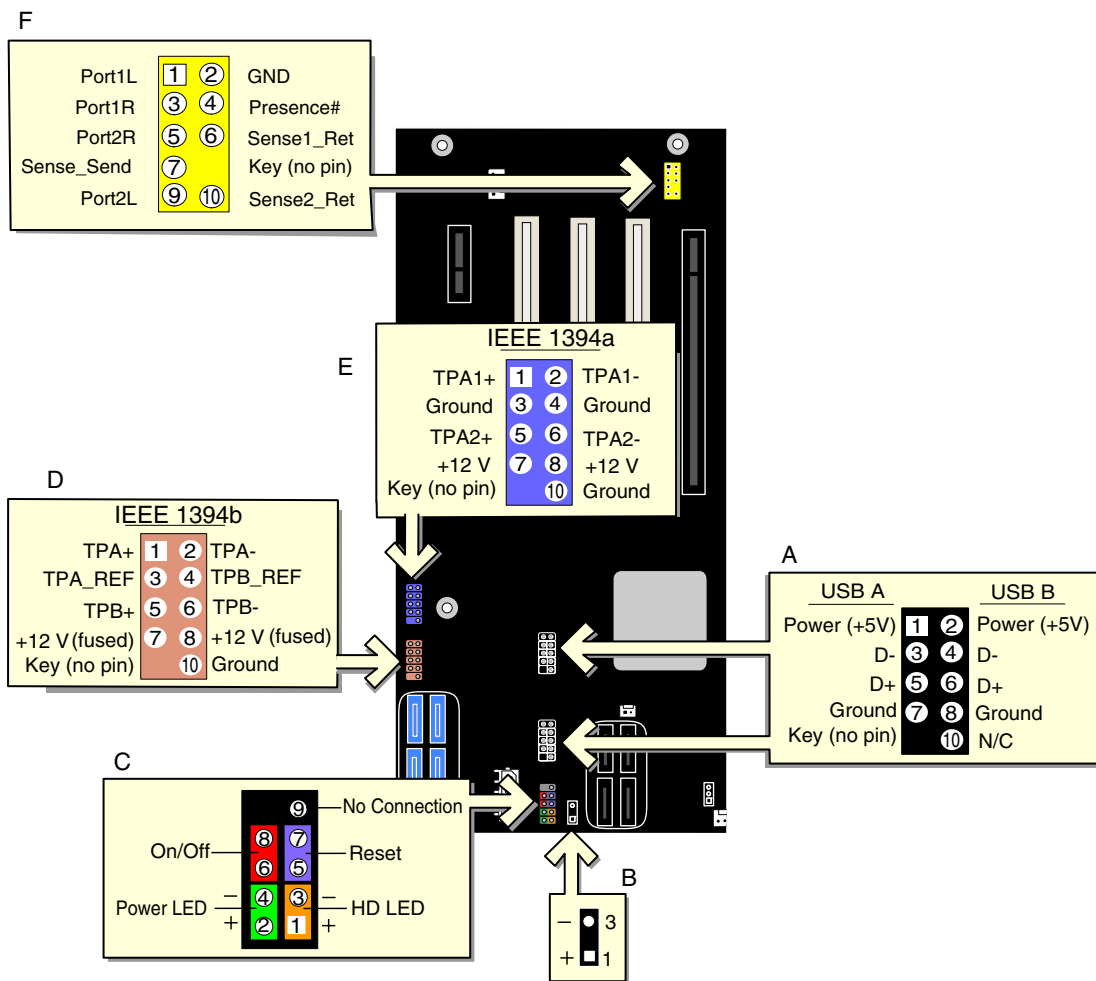

OM17600

Item	Description
A	USB 2.0
B	Alternate power LED
C	Front panel
D	IEEE 1394b
E	IEEE 1394a
F	Front panel audio

Figure 22. Internal Headers

Front Panel Audio Header

Figure 22, F on page 41 shows the location of the yellow front panel audio header. Table 5 shows the pin assignments for the front panel audio header.

Table 5. Front Panel Audio Header Signal Names

Pin	Signal Name	Pin	Signal Name
1	Port1L	2	GND
3	Port1R	4	Presence#
5	Port2R	6	Sense1 Ret
7	Sense Send	8	Key (no pin)
9	Port2L	10	Sense2 Ret

IEEE 1394a/b Headers

See Figure 22, D for the location of the pink IEEE 1394b header. Table 6 shows the pin assignments for the header.

Table 6. IEEE 1394b Header Signal Names

Pin	Signal Name	Pin	Signal Name
1	TPA+	2	TPA-
3	TPA_REF	4	TPB_REF
5	TPB+	6	TPB-
7	+12 V (fused)	8	+12 V (fused)
9	Key (no pin)	10	Ground

See Figure 22, E for the location of the blue IEEE 1394a header. Table 7 shows the pin assignments for the header.

Table 7. IEEE 1394a Header Signal Names

Pin	Signal Name	Pin	Signal Name
1	TPA1+	2	TPA1-
3	Ground	4	Ground
5	TPA2+	6	TPA2-
7	+12 V	8	+12 V
9	Key (no pin)	10	Ground

USB 2.0 Headers

See Figure 22, A for the location of the black USB 2.0 headers. Table 8 shows the pin assignments for the headers.

Table 8. USB 2.0 Header Signal Names

USB Port A		USB Port B	
Pin	Signal Name	Pin	Signal Name
1	Power	2	Power
3	D-	4	D-
5	D+	6	D+
7	Ground	8	Ground
9	Key	10	No connect

Note: USB ports may be assigned as needed.

Front Panel Header

Figure 22, C on page 41 shows the location of the multi-colored front panel header. Table 9 shows the pin assignments for the front panel header.

Table 9. Front Panel Header Signal Names

Pin	Signal	In/Out	Description	Pin	Signal	In/Out	Description
Hard Drive Activity LED (Yellow)				Power LED (Green)			
1	HD_PWR	Out	Hard disk LED pull-up (330 Ω) to +5 V	2	HDR_BLNK_GRN	Out	Front panel green LED
3	HDA#	Out	Hard disk active LED	4	HDR_BLNK_YEL	Out	Front panel yellow LED
Reset Switch (Purple)				On/Off Switch (Red)			
5	Ground		Ground	6	SWITCH_ON#	In	Power switch
7	FP_RESET#	In	Reset switch	8	Ground		Ground
9	N/C		Not connected	10	No pin		

Alternate Power LED Header

Figure 22, B on page 41 shows the location of the alternate power LED header. If you have a three-pin power LED cable, connect it to this header.

Installing the Rear Panel USB 2.0 Adapter

Follow these instructions to install the rear panel USB 2.0 adapter (see Figure 23):

1. Observe the precautions in "Before You Begin" on page 23.
2. Attach the cable end with the connector to the USB 2.0 header on the desktop board.
3. Secure the cable's metal bracket to the chassis back panel with a screw.

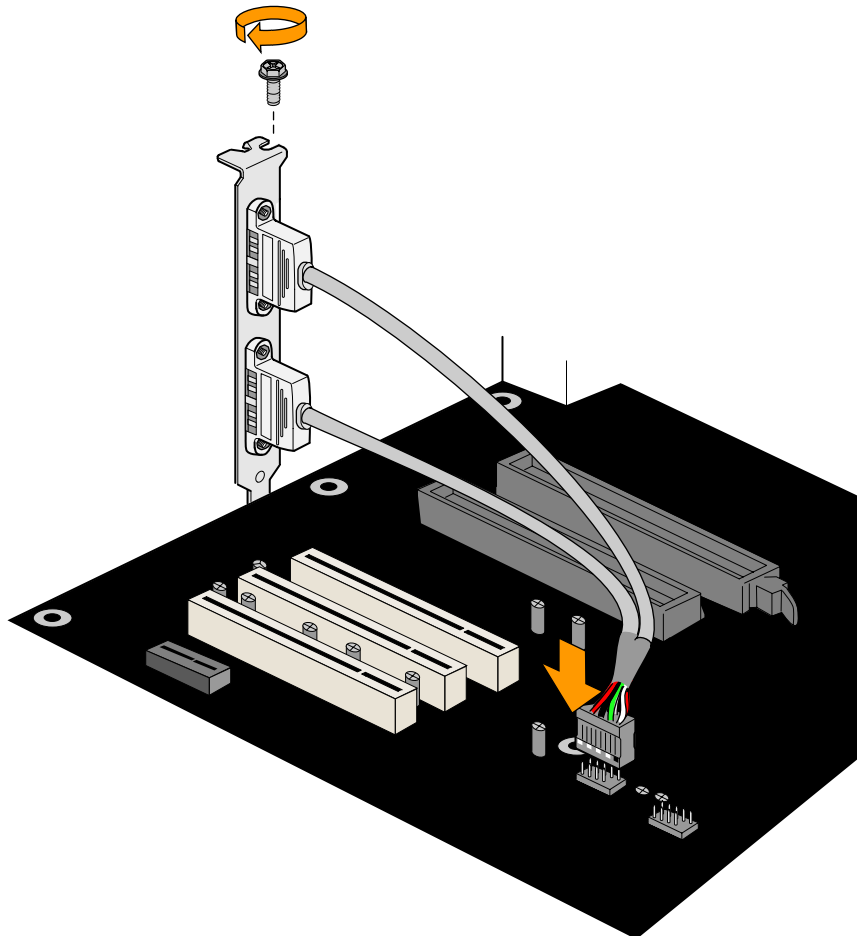

OM17712

Figure 23. Connecting the Rear Panel USB 2.0 Adapter

Installing the Front Panel USB/IEEE 1394/Audio Solution

To install the front panel USB/IEEE 1394/audio solution cables to the headers, follow these steps (see Figure 24):

1. Observe the precautions in "Before You Begin" on page 23.
2. Turn off all peripheral devices connected to the computer. Turn off the computer and disconnect the AC power cord.
3. Remove the cover.
4. Locate the front panel audio header (yellow), USB 2.0 header (black), IEEE 1394a header (blue), and IEEE 1394b header (pink) on the desktop board.
5. Install a correctly keyed and shielded cable.
6. Connect the cables to their respective headers on the desktop board.
7. Replace the cover.

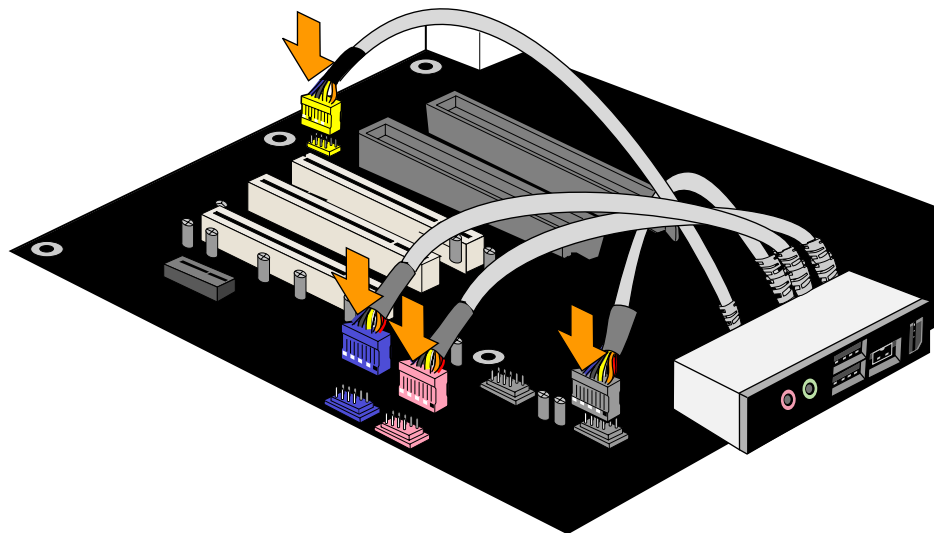

OM17711

Figure 24. Connecting the Front Panel USB/IEEE 1394/Audio Cables

To restore back panel audio, follow these steps:

1. Observe the precautions in "Before You Begin" on page 23.
2. Turn off all peripheral devices connected to the computer. Turn off the computer and disconnect the AC power cord.
3. Remove the cover.
4. Remove the front panel USB/IEEE 1394/audio solution cables.
5. Replace the cover.

Connecting Fans

Connecting Fans and Chassis Intrusion

See Figure 25 for fan and chassis intrusion header locations. Connect the processor's fan heat sink cable to the 4-pin processor fan header on the board. Connect chassis fan cables to the board fan headers and the chassis fan cable to its respective header.

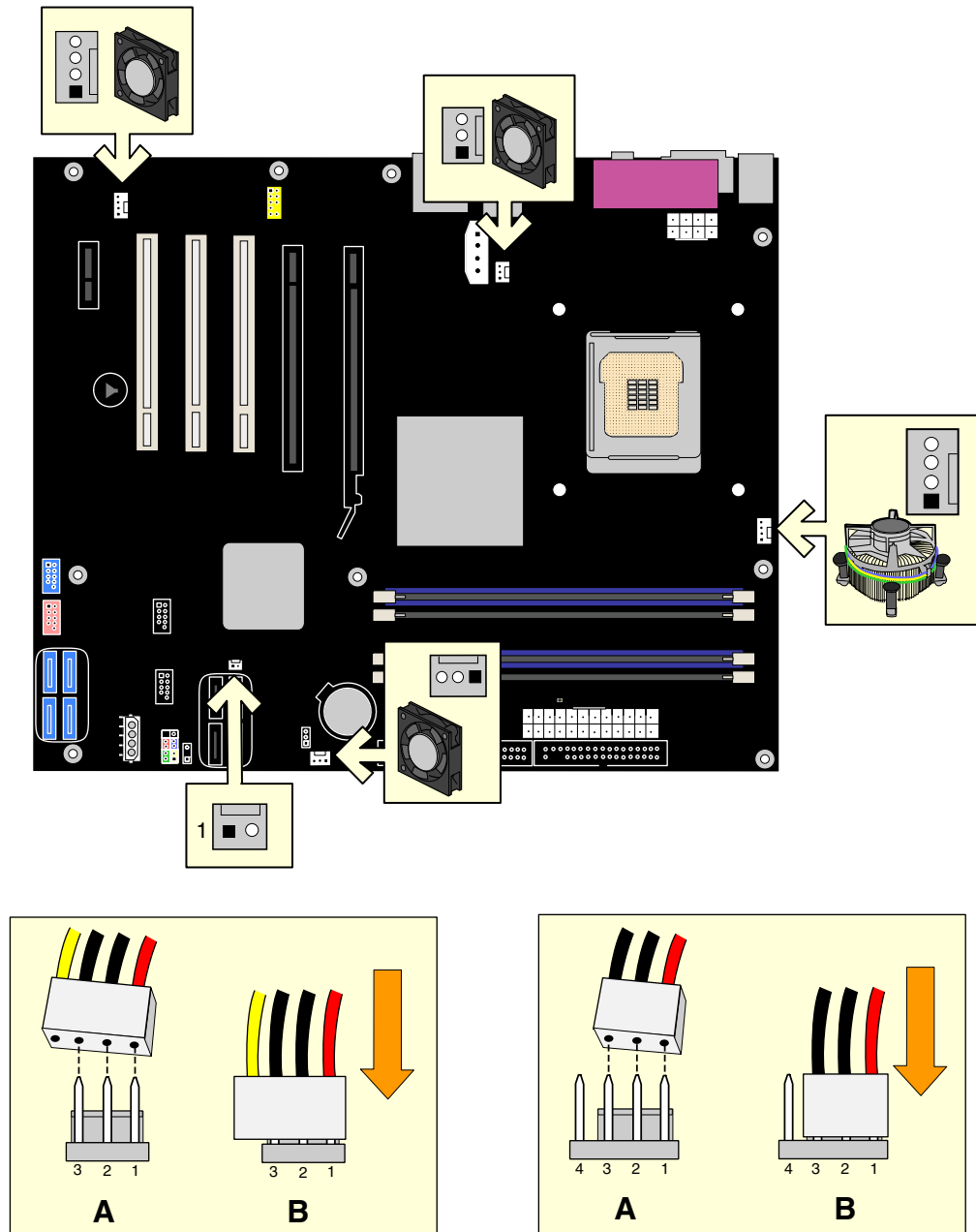

OM17601

Figure 25. Location of Fan Headers

Connecting the Auxiliary Power Output Connector

Figure 26 shows the location of the auxiliary power output connector.

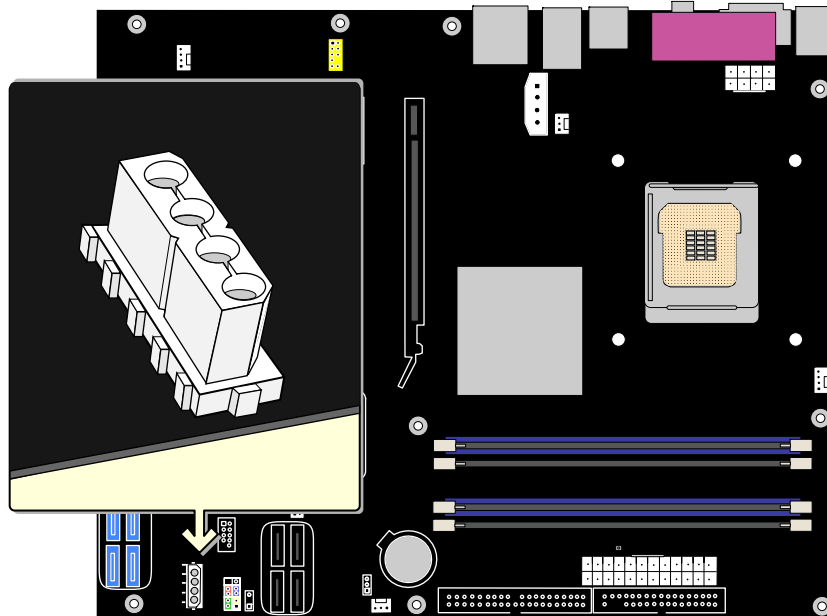

OM17602

Figure 26. Auxiliary Power Output Connector

The D955XBK board includes a male 1x4 power connector that can be used to provide power for internal chassis lighting or additional fans using less than 1.5 A. The 1x4 connector is off by default. You can turn on/off the connector from within the BIOS Setup program under Advanced → Peripheral Configuration → Auxiliary Power.

Use of this connector requires an ATX12V power supply with a 24-pin (2x12) main power cable. If a power supply with a 20-pin (2x10) main power cable is used, the auxiliary power output connector may not function. The connector circuitry includes overcurrent protection components that limit the current draw to a maximum of 1.5 A.



NOTE

Do not use a Y-adaptor, power splitter, or SATA power adapter to attach storage devices (such as hard disk drives or CD/DVD drives) to this connector. This connector will NOT provide adequate power for storage devices.

Connecting Power Cables



NOTE

Failure to use the appropriate power supply and/or not connecting the 12 V (2x4) power connector to the desktop board may result in damage to the board or the system may not function properly.

See Table 3 on page 13 for power supply requirements.

The 2x12 main power connector on the desktop board is backwards compatible with ATX12V power supplies with 2x10 power connections. Use of the 1x4 power connection is recommended with ATX12V power supplies with 2x10 connections when using PCI Express video cards that can consume up to 75 W. Figure 27 shows the location of the power connectors for a 2x10 power supply.

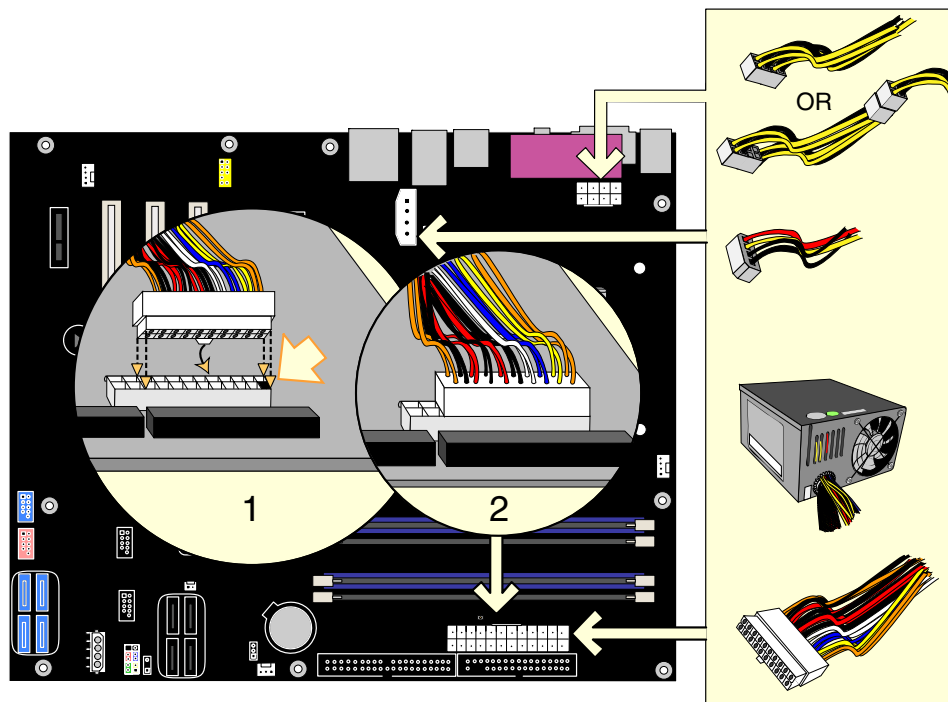

OM17603

Figure 27. Connecting 2x10 Power Supply Cables

1. Observe the precautions in "Before You Begin" on page 23.
2. Connect the 12 V processor core voltage power supply cable to the 2x4 connector. Use the 2x2 to 2x4 adapter if needed.
3. Connect the 1x4 power supply cable to the 1x4 connector.
4. Connect the main 2x10 power supply cable to the 2x12 connector (see Figure 27, 1 and 2).

Connecting 2x12 Power Supply Cables

If you have a 2x12 power supply, follow the instructions below. Figure 27 shows the location of the power connectors for a 2x12 power supply.

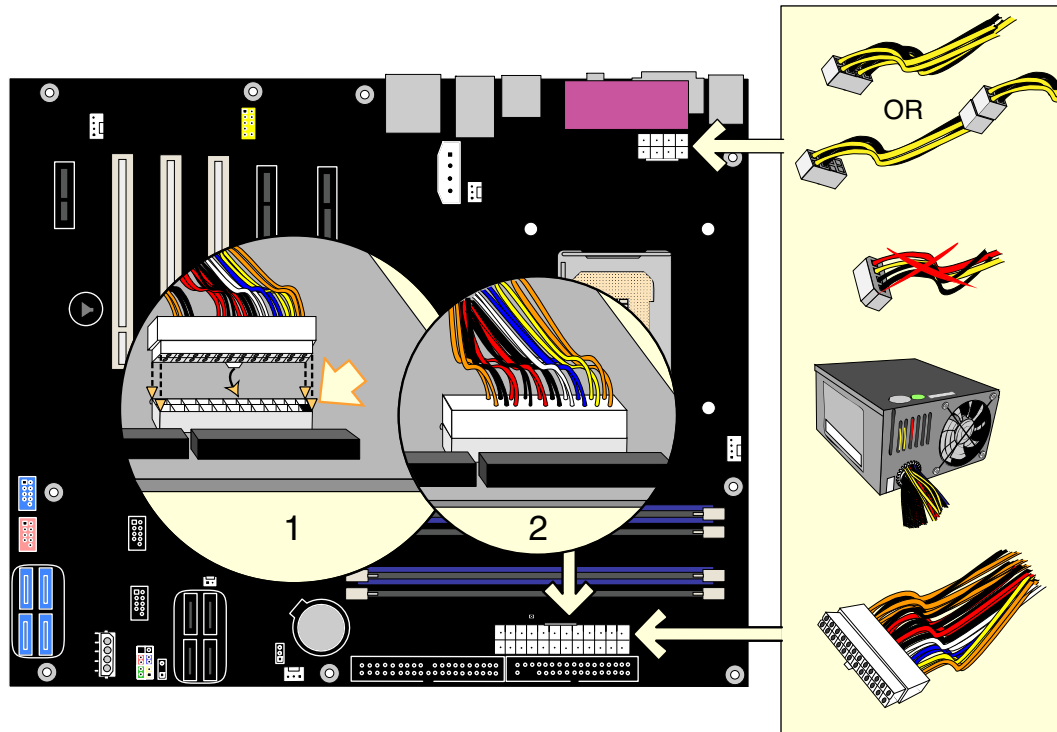

OM17604

Figure 28. Connecting 2x12 Power Supply Cables

1. Observe the precautions in "Before You Begin" on page 23.
2. Connect the 12 V processor core voltage power supply cable to the 2x4 connector. Use the 2x2 to 2x4 adapter if needed.
3. Connect the main 2x12 power supply cable to the 2x12 connector (see Figure 28, 1 and 2).

Other Connectors

Figure 29 shows the location of the other connectors.

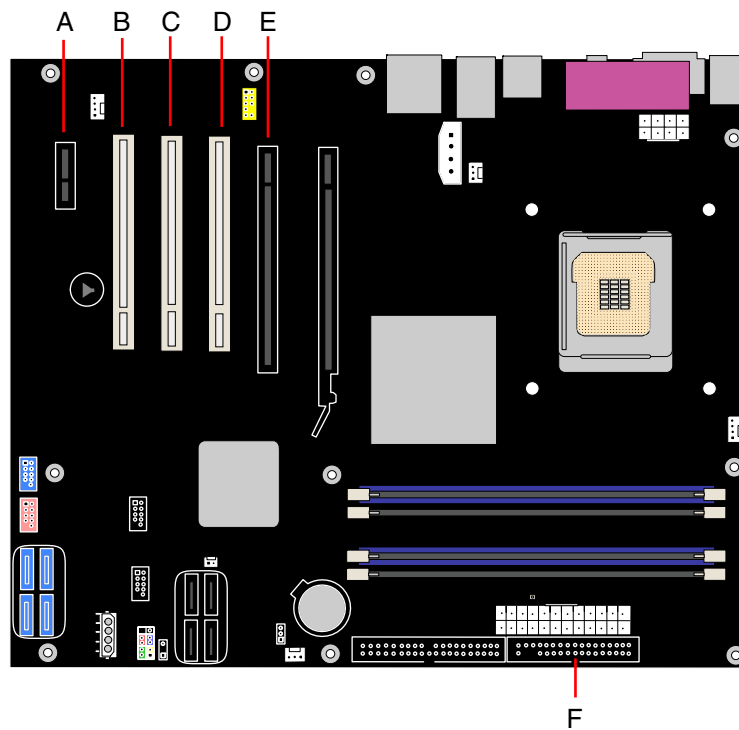

OM17605

Item	Description
A	PCI Express x1 connector
B	PCI bus add-in card connector 3
C	PCI bus add-in card connector 2 (SMBus routed)
D	PCI bus add-in card connector 1
E	PCI Express x4 connector (routed to a physical x16 connector)
F	Floppy drive connector

Figure 29. Location of Other Connectors

Setting the BIOS Configuration Jumper



CAUTION

Always turn off the power and unplug the power cord from the computer before changing the jumper. Moving the jumper with the power on may result in unreliable computer operation.

The location of the desktop board's BIOS configuration jumper is shown in Figure 30.

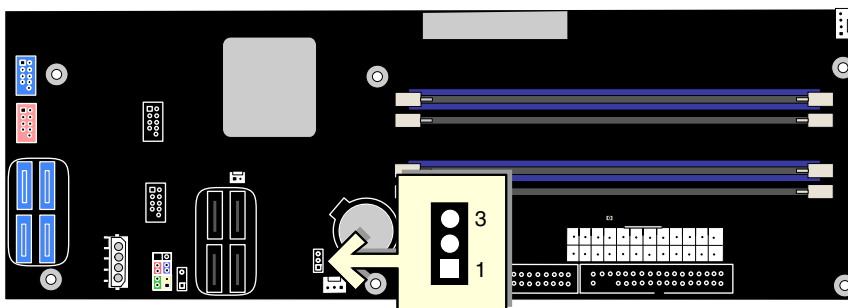



OM17606

Figure 30. Location of the BIOS Configuration Jumper Block

The three-pin BIOS configuration jumper block enables all board configurations to be done in BIOS Setup. Table 10 shows the jumper settings for the Setup program modes.

Table 10. Jumper Settings for the BIOS Setup Program Modes

Jumper Setting	Mode	Description
	Normal (default) (1-2)	The BIOS uses the current configuration and passwords for booting.
	Configure (2-3)	After the Power-On Self-Test (POST) runs, the BIOS displays the Maintenance Menu. Use this menu to clear passwords.
	Recovery (None)	The BIOS recovers data from a recovery diskette in the event of a failed BIOS update.

Clearing Passwords

This procedure assumes that the board is installed in the computer and the configuration jumper block is set to normal mode.

1. Observe the precautions in "Before You Begin" on page 23.
2. Turn off all peripheral devices connected to the computer. Turn off the computer. Disconnect the computer's power cord from the AC power source (wall outlet or power adapter).
3. Remove the computer cover.
4. Find the configuration jumper block (see Figure 30).
5. Place the jumper on pins 2-3 as shown below.



6. Replace the cover, plug in the computer, turn on the computer, and allow it to boot.
7. The computer starts the Setup program. Setup displays the Maintenance menu.
8. Use the arrow keys to select Clear Passwords. Press <Enter> and Setup displays a pop-up screen requesting that you confirm clearing the password. Select Yes and press <Enter>. Setup displays the maintenance menu again.
9. Press <F10> to save the current values and exit Setup.
10. Turn off the computer. Disconnect the computer's power cord from the AC power source.
11. Remove the computer cover.
12. To restore normal operation, place the jumper on pins 1-2 as shown below.



13. Replace the cover, plug in the computer, and turn on the computer.

Back Panel Connectors



NOTE

The line out connector, located on the back panel, is designed to power either headphones or amplified speakers only. Poor audio quality may occur if passive (non-amplified) speakers are connected to this output.

Figure 31 shows the back panel connectors.

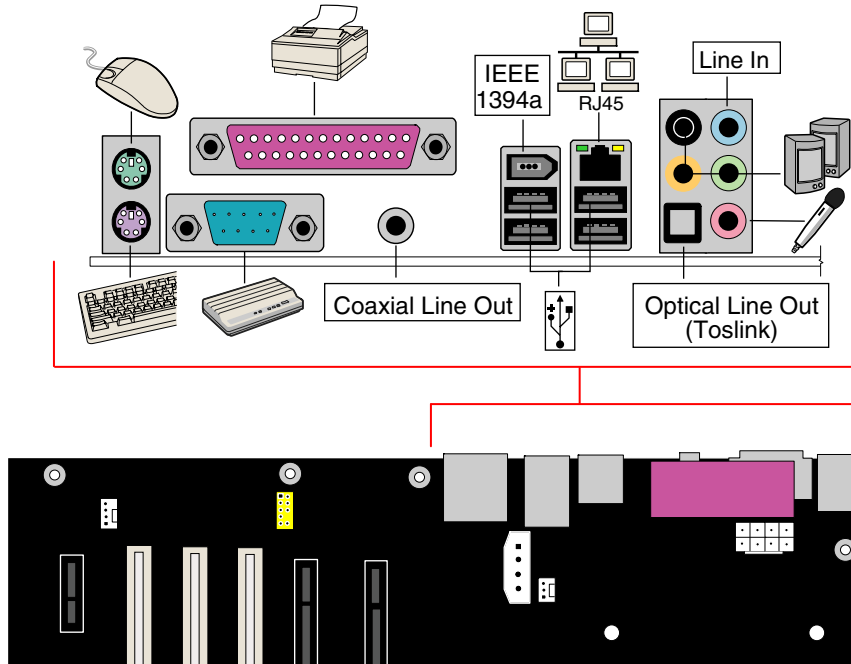

OM17608

Figure 31. Back Panel Connectors

Replacing the Battery

A coin-cell battery (CR2032) powers the real-time clock and CMOS memory. When the computer is not plugged into a wall socket, the battery has an estimated life of three years. When the computer is plugged in, the standby current from the power supply extends the life of the battery. The clock is accurate to ± 13 minutes/year at 25 °C with 3.3 VSB applied.

When the voltage drops below a certain level, the BIOS Setup program settings stored in CMOS RAM (for example, the date and time) might not be accurate. Replace the battery with an equivalent one. Figure 32 on page 57 shows the location of the battery.



CAUTION

Risk of explosion if the battery is replaced with an incorrect type. Batteries should be recycled where possible. Disposal of used batteries must be in accordance with local environmental regulations.



PRÉCAUTION

Risque d'explosion si la pile usagée est remplacée par une pile de type incorrect. Les piles usagées doivent être recyclées dans la mesure du possible. La mise au rebut des piles usagées doit respecter les réglementations locales en vigueur en matière de protection de l'environnement.



FORHOLDSREGEL

Eksplosionsfare, hvis batteriet erstattes med et batteri af en forkert type. Batterier bør om muligt genbruges. Bortskaffelse af brugte batterier bør foregå i overensstemmelse med gældende miljølovgivning.



OBS!

Det kan oppstå eksplosjonsfare hvis batteriet skiftes ut med feil type. Brukte batterier bør kastes i henhold til gjeldende miljølovgivning.



VIKTIGT!

Risk för explosion om batteriet ersätts med felaktig batterityp. Batterier ska kasseras enligt de lokala miljövårdsbestämmelserna.



VARO

Räjähdyksvaara, jos pariston tyyppi on väärä. Paristot on kierrätettävä, jos se on mahdollista. Käytetyt paristot on hävitettävä paikallisten ympäristömääräysten mukaisesti.



VORSICHT

Bei falschem Einsetzen einer neuen Batterie besteht Explosionsgefahr. Die Batterie darf nur durch denselben oder einen entsprechenden, vom Hersteller empfohlenen Batterietyp ersetzt werden. Entsorgen Sie verbrauchte Batterien den Anweisungen des Herstellers entsprechend.

**AVVERTIMENTO**

Esiste il pericolo di un esplosione se la pila non viene sostituita in modo corretto. Utilizzare solo pile uguali o di tipo equivalente a quelle consigliate dal produttore. Per disfarsi delle pile usate, seguire le istruzioni del produttore.

**PRECAUCIÓN**

Existe peligro de explosión si la pila no se cambia de forma adecuada. Utilice solamente pilas iguales o del mismo tipo que las recomendadas por el fabricante del equipo. Para deshacerse de las pilas usadas, siga igualmente las instrucciones del fabricante.

**WAARSCHUWING**

Er bestaat ontploffingsgevaar als de batterij wordt vervangen door een onjuist type batterij. Batterijen moeten zoveel mogelijk worden gerecycled. Houd u bij het weggooien van gebruikte batterijen aan de plaatselijke milieuwetgeving.

**ATENÇÃO**

Haverá risco de explosão se a bateria for substituída por um tipo de bateria incorreto. As baterias devem ser recicladas nos locais apropriados. A eliminação de baterias usadas deve ser feita de acordo com as regulamentações ambientais da região.

**AŠCIAROŽNÁŠĆ**

Иснуе рызыка выбуху, калі заменены акумулятар непраўльнага тыпу. Акумулятары павінны, па магчымасці, перепрацоўвацца. Пазбаўляцца ад старых акумулятараў патрэбна згодна з мясцовым заканадаўствам па экалогіі.

**UPOZORNĚNÍ**

V případě výměny baterie za nesprávný druh může dojít k výbuchu. Je-li to možné, baterie by měly být recyklovány. Baterie je třeba zlikvidovat v souladu s místními předpisy o životním prostředí.

**Προσοχή**

Υπάρχει κίνδυνος για έκρηξη σε περίπτωση που η μπαταρία αντικατασταθεί από μία λανθασμένου τύπου. Οι μπαταρίες θα πρέπει να ανακυκλώνονται όταν κάτι τέτοιο είναι δυνατό. Η απόρριψη των χρησιμοποιημένων μπαταριών πρέπει να γίνεται σύμφωνα με τους κατά τόπο περιβαλλοντικούς κανονισμούς.

**VIGYÁZAT**

Ha a telepet nem a megfelelő típusú telepre cseréli, az felrobbanhat. A telepeket lehetőség szerint újra kell hasznosítani. A használt telepeket a helyi környezetvédelmi előírásoknak megfelelően kell kiselejtezni.



注意

異なる種類の電池を使用すると、爆発の危険があります。リサイクルが可能な地域であれば、電池をリサイクルしてください。使用後の電池を破棄する際には、地域の環境規制に従ってください。



AWAS

Risiko letupan wujud jika bateri digantikan dengan jenis yang tidak betul. Bateri sepatutnya dikitar semula jika boleh. Pelupusan bateri terpakai mestilah mematuhi peraturan alam sekitar tempatan.



OSTRZEŻENIE

Istnieje niebezpieczeństwo wybuchu w przypadku zastosowania niewłaściwego typu baterii. Zużyte baterie należy w miarę możliwości utylizować zgodnie z odpowiednimi przepisami ochrony środowiska.



PRECAUȚIE

Risc de explozie, dacã bateria este înlocuitã cu un tip de baterie necorespunzãtor. Bateriile trebuie reciclate, dacã este posibil. Depozitarea bateriilor uzate trebuie sã respecte reglementãrile locale privind protecția mediului.



ВНИМАНИЕ

При использовании батареи несоответствующего типа существует риск ее взрыва. Батареи должны быть утилизированы по возможности. Утилизация батарей должна проводиться по правилам, соответствующим местным требованиям.



UPOZORNENIE

Ak batériu vymeníte za nesprávny typ, hrozí nebezpečenstvo jej výbuchu. Batérie by sa mali podľa možnosti vždy recyklovať. Likvidácia použitých batérií sa musí vykonávať v súlade s miestnymi predpismi na ochranu životného prostredia.



POZOR

Zamenjava baterije z baterijo drugačnega tipa lahko povzroči eksplozijo. Če je mogoče, baterije reciklirajte. Rabljene baterije zavrzite v skladu z lokalnimi okoljevarstvenimi predpisi.



การระวัง

ระวังการระเบิดที่เกิดจากเปลี่ยนแบตเตอรี่ผิดประเภท หากเป็นไปได้ ควรนำแบตเตอรี่ไปรีไซเคิล การทิ้งแบตเตอรี่ใช้แล้วต้องเป็นไปตามกฎข้อบังคับด้านสิ่งแวดล้อมของท้องถิ่น.

**UYARI**

Yanlış türde pil takıldığında patlama riski vardır. Piller mümkün olduğunda geri dönüştürülmelidir. Kullanılmış piller, yerel çevre yasalarına uygun olarak atılmalıdır.

**ОСТОРОГА**

Використовуйте батареї правильного типу, інакше існуватиме ризик вибуху. Якщо можливо, використані батареї слід утилізувати. Утилізація використаних батарей має бути виконана згідно місцевих норм, що регулюють охорону довкілля.

To replace the battery, follow these steps:

1. Observe the precautions in "Before You Begin" on page 23.
2. Turn off all peripheral devices connected to the computer. Disconnect the computer's power cord from the AC power source (wall outlet or power adapter).
3. Remove the computer cover.
4. Locate the battery on the board (see Figure 32).
5. With a medium flat-bladed screwdriver, gently pry the battery free from its connector. Note the orientation of the "+" and "-" on the battery.
6. Install the new battery in the connector, orienting the "+" and "-" correctly.
7. Replace the computer cover.

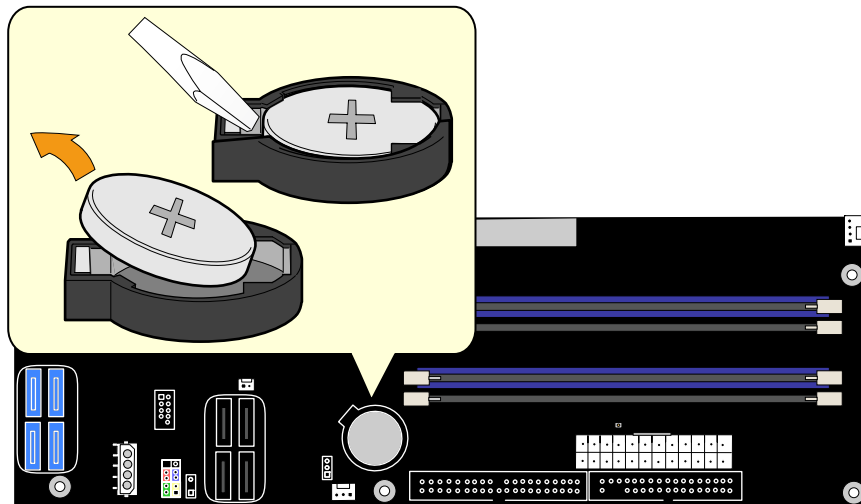

OM17607

Figure 32. Removing the Battery

3 BIOS

The BIOS Setup program is accessed by pressing the <F2> key after the Power-On Self-Test (POST) memory test begins and before the operating system boot begins.

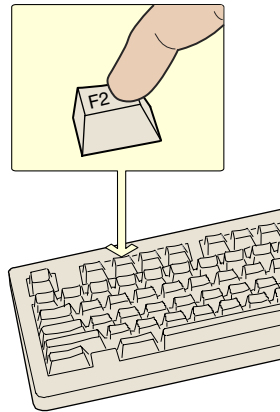

OM17050

Figure 33. F2 Key

For the latest BIOS Setup menu options, go to the Intel World Wide Web site:

<http://support.intel.com/support/motherboards/desktop/>

Updating the BIOS

The BIOS can be updated by either using the Intel Express BIOS Update utility or the Iflash Memory Update utility.

Updating the BIOS with the Intel® Express BIOS Update Utility

With the Intel Express BIOS Update utility you can update the system BIOS while in the Windows environment. The BIOS file is included in an automated update utility that combines the functionality of the Intel® Flash Memory Update Utility and the ease-of use of Windows-based installation wizards.

To update the BIOS with the Intel Express BIOS Update utility:

1. Go to the Intel World Wide Web site:
<http://support.intel.com/support/motherboards/desktop/>
2. Navigate to the D955XBK page, click “[view] Latest BIOS updates,” and select the Express BIOS Update utility file.
3. Download the file to your hard drive. (You can also save this file to a diskette. This is useful if you are updating the BIOS for multiple identical systems.)
4. Close all other applications. This step is required. Your system will be rebooted at the last Express BIOS Update window.

5. Double-click the executable file from the location on your hard drive where it was saved. This runs the update program.
6. Follow the instructions provided in the dialog boxes to complete the BIOS update.

Updating the BIOS with the Iflash Memory Update Utility

With the Iflash BIOS update utility you can update the system BIOS from a floppy disk or other bootable media. The utility available from the Web provides a simple method for creating a bootable flash memory update floppy that will automatically update your BIOS.

Obtaining the BIOS Update File

You can update to a new version of the BIOS by using the BIOS update file. The BIOS update file is a compressed self-extracting archive that contains all the files you need to update the BIOS. The BIOS update file contains:

- New BIOS files
- BIOS recovery files
- Intel Flash Memory Update Utility

You can obtain the BIOS update file through your computer supplier or by navigating to the Desktop Board D955XBK page on the Intel World Wide Web site at:

<http://support.intel.com/support/motherboards/desktop>

Navigate to the D955XBK page, click “[view] Latest BIOS updates,” and select the Iflash BIOS Update utility file.



NOTE

Review the instructions distributed with the update utility before attempting a BIOS update.

The Iflash Memory Update utility allows you to:

- Update the BIOS in flash memory
- Update the language section of the BIOS

Updating the BIOS



CAUTION

The AUTOEXEC.BAT file provided with the update files updates the BIOS. Do not interrupt the process or the system may not function.

1. Boot the computer with the BIOS update diskette in drive A. During system boot, the AUTOEXEC.BAT file provided with the update files will automatically run the BIOS update process.
2. When the update process is complete, the monitor will display a message telling you to remove the diskette and to reboot the system.
3. As the computer boots, check the BIOS identifier (version number) to make sure the update was successful. If a logo appears, press <Esc> to view the POST messages.

Recovering the BIOS

It is unlikely that anything will interrupt the BIOS update; however, if an interruption occurs, the BIOS could be damaged. The following steps explain how to recover the BIOS if an update fails. The following procedure uses recovery mode for the Setup program. See page 51 for more information on Setup modes.



NOTE

Because of the small amount of code available in the boot block area, there is no video support. You will not see anything on the screen during this procedure. Monitor the procedure by listening to the speaker and looking at the diskette drive LED.

1. Turn off the computer, disconnect the computer's power cord, and disconnect all external peripherals.
2. Remove the computer cover and locate the configuration jumper block (see Figure 30).
3. Remove the jumper from all pins as shown below to set recovery mode for Setup.
4. Insert the bootable BIOS update diskette into diskette drive A.
5. Replace the computer cover, connect the power cord, turn on the computer, and allow it to boot. The recovery process will take a few minutes.
6. Listen to the speaker:
 - Upon applying power, drive A will begin to show activity. In about a minute, two beeps are heard and drive A activity ceases (temporarily) indicating the successful recovery of the BIOS core. Drive A activity will begin again followed by two more beeps indicating the successful recovery of the boot block. This sequence of events indicates a successful BIOS recovery.
 - A series of continuous beeps indicates a failed BIOS recovery.
7. If recovery fails, return to step 1 and repeat the recovery process.
8. If recovery is successful, turn off the computer, and disconnect its power cord.
9. Remove the computer cover and continue with the following steps.
10. On the jumper block, reinstall the jumper back on pins 1-2 as shown below to set normal mode for Setup.
11. Leave the update diskette in drive A, replace the computer cover, and connect the computer's power cord.
12. Turn on the computer and continue with the BIOS update.

4 Configuring for RAID (Intel® Matrix Storage Technology)

Requires Microsoft Windows* XP or 2000 and SATA Hard Drive(s)

Configuring the BIOS for Intel Matrix Storage Technology

1. Assemble your system and attach two or more SATA hard drives to the black SATA connectors.
2. Enter system BIOS Setup by pressing the <F2> key after the Power-On-Self-Test (POST) memory tests begin.
3. Go to **Advanced** → **Drive Configuration** → **Configure SATA as**; ensure **RAID** is selected.
4. Then save your settings by pressing <F10>.

Creating Your RAID Set

1. Upon re-boot, you will see the following Intel® Matrix Storage Manager option ROM status message on the screen: Press <Ctrl-I> to enter the RAID Configuration Utility. Press <Ctrl-I> and enter the RAID Configuration Utility.
2. In the Intel Matrix Storage Manager option ROM Main Menu, select option #1: Create RAID Volume. Enter a volume name and press <Enter>.
NOTE: The RAID Volume name must be in English alphanumeric ASCII characters.
3. Use the arrow keys to select RAID 0 or RAID 1 (if only two SATA drives are available), RAID 5 and RAID 10 (these options will only appear if three or four SATA drives are installed respectively). Press <Enter> once you have selected the RAID LEVEL.
4. Select the drives to be used in the RAID array (only if there are more than two drives available) and press <Enter>.
5. Select the strip size, if necessary, and press <Enter>.
6. Enter the size of the volume (if you enter less than the maximum volume size, you can then create a second RAID array on the remaining portion of your volume) and press <Enter>.
7. Finally, press <Enter> to **Create Volume**.
8. Exit the Option ROM user interface by pressing <Esc> or going to the EXIT option in the MAIN MENU.

Loading the Intel Matrix Storage Technology RAID Drivers and Software

1. Begin Windows Setup by booting from the Windows installation CD.
2. At the beginning of Windows Setup, press <F6> to install a third-party SCSI or RAID driver. When prompted, insert the floppy disk labeled **RAID Driver**. Install the **Intel® 82801GR SATA RAID Controller** driver.
3. Finish the Windows installation and install all necessary drivers.
4. Install the Intel Matrix Storage Console software via the Intel Express Installer CD included with your desktop board or after downloading it from the Internet at <http://support.intel.com/support/motherboards/desktop/>. The Intel Matrix Storage Console software can be used to manage the RAID configuration.

Setting Up a “RAID Ready” System

The Intel Matrix Storage Technology Console software offers the flexibility to upgrade from a single Serial ATA drive to RAID without reinstalling the operating system, when a second SATA hard drive is added to the system.

Follow the steps described in the headings from this section: "**Configuring the BIOS for Intel Matrix Storage Technology**" and "**Loading the Intel Matrix Storage Technology RAID Drivers and Software**".

Once additional SATA drives have been added, open the Intel Matrix Storage Technology Console Software and follow the directions to update to a RAID setup.

A Error Messages and Indicators

Desktop Board D955XBK reports POST errors in two ways:

- By sounding a beep code
- By displaying an error message on the monitor

BIOS Beep Codes

The BIOS beep codes are listed in Table 11. The BIOS also issues a beep code (one long tone followed by two short tones) during POST if the video configuration fails (a faulty video card or no card installed) or if an external ROM module does not properly checksum to zero.

Table 11. Beep Codes

Beep	Description
3	No memory
Siren	CPU overheat (on reboot)

BIOS Error Messages

When a recoverable error occurs during the POST, the BIOS displays an error message describing the problem.

Table 12. BIOS Error Messages

Error Message	Explanation
PROCESSOR_THERMAL_TRIP_ERROR	CPU was previously shutdown due to a thermal event (overheating).
MULTI_BIT_ECC_ERROR	The firmware has detected that a Multi-Bit ECC Error occurred.
SINGLE_BIT_ECC_ERROR	The firmware has detected that a Single-Bit ECC Error occurred.
CMOS_BATTERY_ERROR	The firmware has detected that a CMOS battery failure occurred.
CMOS_CHECKSUM_ERROR	The firmware has detected that a CMOS Checksum Error occurred.
CMOS_TIMER_ERROR	The firmware has detected that the system date/time has not been set.
MEMORY_SIZE_DECREASE_ERROR	The firmware has detected that the system memory has decreased.
INTRUDER_DETECTION_ERROR	The system chassis was opened.
SPD_TOLER_ERROR	SERIAL PRESENCE DETECT (SPD) device data missing or inconclusive. Properly programmed SPD device data is required for reliable operation. DDR2 533 MHz memory assumed at slowest timings.
MEM_OPTIMAL_ERROR	The installed amount of memory in Channel A is not equal to the amount of memory in Channel B. Maximum memory performance is achieved with equal amounts of memory installed in each channel.

B Regulatory Compliance

This appendix contains the following regulatory compliance information for Desktop Board D955XBK:

- Safety regulations
- European Union Declaration of Conformity statement
- Product Ecology statements
- Electromagnetic Compatibility (EMC) regulations
- Product certification markings

Safety Regulations

Desktop Board D955XBK complies with the safety regulations stated in Table 13 when correctly installed in a compatible host system.

Table 13. Safety Regulations

Regulation	Title
UL 60950-1:2003/ CSA C22.2 No. 60950-1-03	Information Technology Equipment – Safety - Part 1: General Requirements (USA and Canada)
EN 60950-1:2002	Information Technology Equipment – Safety - Part 1: General Requirements (European Union)
IEC 60950-1:2001, First Edition	Information Technology Equipment – Safety - Part 1: General Requirements (International)

European Union Declaration of Conformity Statement

We, Intel Corporation, declare under our sole responsibility that the product Intel® Desktop Board D955XBK is in conformity with all applicable essential requirements necessary for CE marking, following the provisions of the European Council Directive 89/336/EEC (EMC Directive) and Council Directive 73/23/EEC (Safety/Low Voltage Directive).

The product is properly CE marked demonstrating this conformity and is for distribution within all member states of the EU with no restrictions.



This product follows the provisions of the European Directives 89/336/EEC and 73/23/EEC.

Čeština Tento výrobek odpovídá požadavkům evropských směrnic 89/336/EEC a 73/23/EEC.

Dansk Dette produkt er i overensstemmelse med det europæiske direktiv 89/336/EEC & 73/23/EEC.

Dutch Dit product is in navolging van de bepalingen van Europees Directief 89/336/EEC & 73/23/EEC.

Eesti Antud toode vastab Euroopa direktiivides 89/336/EEC ja 73/23/EEC kehtestatud nõuetele.

Suomi Tämä tuote noudattaa EU-direktiivin 89/336/EEC & 73/23/EEC määräyksiä.

Français Ce produit est conforme aux exigences de la Directive Européenne 89/336/EEC & 73/23/EEC.

Deutsch Dieses Produkt entspricht den Bestimmungen der Europäischen Richtlinie 89/336/EEC & 73/23/EEC.

Ελληνικά Το παρόν προϊόν ακολουθεί τις διατάξεις των Ευρωπαϊκών Οδηγιών 89/336/ΕΟΚ και 73/23/ΕΟΚ.

Magyar E termék megfelel a 89/336/EEC és 73/23/EEC Európai Irányelv előírásainak.

Icelandic Þessi vara stenst reglugerð Evrópska Efnahags Bandalagsins númer 89/336/ EEC & 73/23/EEC.

Italiano Questo prodotto è conforme alla Direttiva Europea 89/336/EEC & 73/23/EEC.

Latviešu Šis produkts atbilst Eiropas Direktīvu 89/336/EEC un 73/23/EEC noteikumiem.

Lietuvių Šis produktas atitinka Europos direktyvų 89/336/EEC ir 73/23/EEC nuostatas.

Malti Dan il-prodott hu konformi mal-provvedimenti tad-Direttivi Ewropej 89/336/EEC u 73/23/EEC.

Norsk Dette produktet er i henhold til bestemmelsene i det europeiske direktivet 89/336/ EEC & 73/23/EEC.

Polski Niniejszy produkt jest zgodny z postanowieniami Dyrektyw Unii Europejskiej 89/336/EWG i 73/23/EWG.

Portuguese Este produto cumpre com as normas da Diretiva Europeia 89/336/EEC & 73/23/EEC.

Español Este producto cumple con las normas del Directivo Europeo 89/336/EEC & 73/23/EEC.

Slovensky..Tento produkt je v súlade s ustanoveniami európskych direktív 89/336/EEC a 73/23/EEC.

Slovenščina Izdelek je skladen z določbami evropskih direktiv 89/336/EGS in 73/23/EGS.

Svenska Denna produkt har tillverkats i enlighet med EG-direktiv 89/336/EEC & 73/23/EEC.

Türkçe Bu ürün, Avrupa Birliği'nin 89/336/EEC ve 73/23/EEC yönergelerine uyar.

Product Ecology Statements

The following information is provided to address worldwide product ecology concerns and regulations.

Recycling Considerations

As part of its commitment to environmental responsibility, Intel has implemented the Intel Product Recycling Program to allow retail consumers of Intel's branded products to return used products to select locations for proper recycling.

Please consult the http://www.intel.com/intel/other/ehs/product_ecology/Recycling_Program.htm for the details of this program, including the scope of covered products, available locations, shipping instructions, terms and conditions, etc.

中文

作为其对环境责任之承诺的部分，英特尔已实施 Intel Product Recycling Program（英特尔产品回收计划），以允许英特尔品牌产品的零售消费者将使用过的产品退还至指定地点作恰当的重复使用处理。

请参考http://www.intel.com/intel/other/ehs/product_ecology/Recycling_Program.htm了解此计划的详情，包括涉及产品之范围、回收地点、运送指导、条款和条件等。

Deutsch

Als Teil von Intels Engagement für den Umweltschutz hat das Unternehmen das Intel Produkt-Recyclingprogramm implementiert, das Einzelhandelskunden von Intel Markenprodukten ermöglicht, gebrauchte Produkte an ausgewählte Standorte für ordnungsgemäßes Recycling zurückzugeben.

Details zu diesem Programm, einschließlich der darin eingeschlossenen Produkte, verfügbaren Standorte, Versandanweisungen, Bedingungen usw., finden Sie auf der http://www.intel.com/intel/other/ehs/product_ecology/Recycling_Program.htm.

Español

Como parte de su compromiso de responsabilidad medioambiental, Intel ha implantado el programa de reciclaje de productos Intel, que permite que los consumidores al detalle de los productos Intel devuelvan los productos usados en los lugares seleccionados para su correspondiente reciclado.

Consulte la http://www.intel.com/intel/other/ehs/product_ecology/Recycling_Program.htm para ver los detalles del programa, que incluye los productos que abarca, los lugares disponibles, instrucciones de envío, términos y condiciones, etc.

Français

Dans le cadre de son engagement pour la protection de l'environnement, Intel a mis en œuvre le programme Intel Product Recycling Program (Programme de recyclage des produits Intel) pour permettre aux consommateurs de produits Intel de recycler les produits usés en les retournant à des adresses spécifiées.

Visitez la page Web http://www.intel.com/intel/other/ehs/product_ecology/Recycling_Program.htm pour en savoir plus sur ce programme, à savoir les produits concernés, les adresses disponibles, les instructions d'expédition, les conditions générales, etc.

日本語

インテルでは、環境保護活動の一環として、使い終わったインテルブランド製品を指定の場所へ返送していただき、リサイクルを適切に行えるよう、インテル製品リサイクルプログラムを発足させました。

対象製品、返送先、返送方法、ご利用規約など、このプログラムの詳細情報は、http://www.intel.com/intel/other/ehs/product_ecology/Recycling_Program.htm (英語)をご覧ください。

Malay

Sebagai sebahagian daripada komitmennya terhadap tanggungjawab persekitaran, Intel telah melaksanakan Program Kitar Semula Produk untuk membenarkan pengguna-pengguna runcit produk jenama Intel memulangkan produk terguna ke lokasi-lokasi terpilih untuk dikitar semula dengan betul.

Sila rujuk http://www.intel.com/intel/other/ehs/product_ecology/Recycling_Program.htm untuk mendapatkan butir-butir program ini, termasuklah skop produk yang dirangkumi, lokasi-lokasi tersedia, arahan penghantaran, terma & syarat, dsb.

Portuguese

Como parte deste compromisso com o respeito ao ambiente, a Intel implementou o Programa de Reciclagem de Produtos para que os consumidores finais possam enviar produtos Intel usados para locais selecionados, onde esses produtos são reciclados de maneira adequada.

Consulte o site http://www.intel.com/intel/other/ehs/product_ecology/Recycling_Program.htm (em Inglês) para obter os detalhes sobre este programa, inclusive o escopo dos produtos cobertos, os locais disponíveis, as instruções de envio, os termos e condições, etc.

Russian

В качестве части своих обязательств к окружающей среде, в Intel создана программа утилизации продукции Intel (Product Recycling Program) для предоставления конечным пользователям марок продукции Intel возможности возврата используемой продукции в специализированные пункты для должной утилизации.

Пожалуйста, обратитесь на веб-сайт

http://www.intel.com/intel/other/ehs/product_ecology/Recycling_Program.htm за информацией об этой программе, принимаемых продуктах, местах приема, инструкциях об отправке, положениях и условиях и т.д.

Türkçe

Intel, çevre sorumluluğuna bağlılığının bir parçası olarak, perakende tüketicilerin Intel markalı kullanılmış ürünlerini belirlenmiş merkezlere iade edip uygun şekilde geri dönüştürmesini amaçlayan Intel Ürünleri Geri Dönüşüm Programı'nı uygulamaya koymuştur.

Bu programın ürün kapsamı, ürün iade merkezleri, nakliye talimatları, kayıtlar ve şartlar v.s dahil bütün ayrıntılarını öğrenmek için lütfen

http://www.intel.com/intel/other/ehs/product_ecology/Recycling_Program.htm

web sayfasına gidin.

Lead Free Desktop Board

The desktop board is lead free. Other box contents may contain lead.

Table 14. Lead Free Desktop Board

Description	Mark
<p>Lead-Free: The symbol is used to identify electrical and electronic assemblies and components in which the lead (Pb) concentration level in any of the raw materials and the end product is not greater than 0.1% by weight (1000 ppm). This symbol is also used to indicate conformance to lead-free requirements and definitions adopted under the European Union's Restriction on Hazardous Substances (RoHS) directive, 2002/95/EC.</p>	

EMC Regulations

Desktop Board D955XBK complies with the EMC regulations stated in Table 15 when correctly installed in a compatible host system.

Table 15. EMC Regulations

Regulation	Title
FCC Class B	Title 47 of the Code of Federal Regulations, Parts 2 and 15, Subpart B, Radio Frequency Devices. (USA)
ICES-003 (Class B)	Interference-Causing Equipment Standard, Digital Apparatus. (Canada)
EN55022: 1998 (Class B)	Limits and methods of measurement of Radio Interference Characteristics of Information Technology Equipment. (European Union)
EN55024: 1998	Information Technology Equipment – Immunity Characteristics Limits and methods of measurement. (European Union)
AS/NZS CISPR22 (Class B)	Australian Communications Authority, Standard for Electromagnetic Compatibility. (Australia and New Zealand)
CISPR 22, 3 rd Edition, (Class B)	Limits and methods of measurement of Radio Disturbance Characteristics of Information Technology Equipment. (International)
CISPR 24: 1997	Information Technology Equipment – Immunity Characteristics – Limits and Methods of Measurement. (International)
VCCI (Class B)	Voluntary Control for Interference by Information Technology Equipment (Japan)

Japanese Kanji statement translation: This is a Class B product based on the standard of the Voluntary Control Council for Interference from Information Technology Equipment (VCCI). If this is used near a radio or television receiver in a domestic environment, it may cause radio interference. Install and use the equipment according to the instruction manual.

この装置は、情報処理装置等電波障害自主規制協議会（VCCI）の基準に基づくクラスB情報技術装置です。この装置は、家庭環境で使用することを目的としていますが、この装置がラジオやテレビジョン受信機に近接して使用されると、受信障害を引き起こすことがあります。
取扱説明書に従って正しい取り扱いをして下さい。







Korean Class B statement translation: This is household equipment that is certified to comply with EMC requirements. You may use this equipment in residential environments and other non-residential environments.

이 기기는 가정용으로 전자파적합등록을 한 기기로서 주거지역에서는 물론 모든 지역에서 사용할 수 있습니다.

Product Certification Markings (Board Level)

Desktop Board D955XBK has the following product certification markings:

Table 16. Product Certification Markings

Description	Mark
UL joint US/Canada Recognized Component mark. Includes adjacent UL file number for Intel desktop boards: E210882.	
FCC Declaration of Conformity logo mark for Class B equipment. Includes Intel name and D955XBK model designation.	
CE mark. Declaring compliance to European Union (EU) EMC directive (89/336/EEC) and Low Voltage directive (73/23/EEC).	
Australian Communications Authority (ACA) C-tick mark. Includes adjacent Intel supplier code number, N-232.	
Japan VCCI (Voluntary Control Council for Interference) mark.	
S. Korea MIC (Ministry of Information and Communication) mark. For information about MIC certification, go to http://support.intel.com/support/motherboards/desktop/	
Taiwan BSMI (Bureau of Standards, Metrology and Inspections) mark. Includes adjacent Intel company number, D33025.	
Printed wiring board manufacturer's recognition mark. Consists of a unique UL recognized manufacturer's logo, along with a flammability rating (solder side).	V-0

