

# Intel<sup>®</sup> RAID Controller RS2PI008 Hardware User's Guide

Intel Order Number: E64395-001

INFORMATION IN THIS DOCUMENT IS PROVIDED IN CONNECTION WITH INTEL(R) PRODUCTS. NO LICENSE, EXPRESS OR IMPLIED, BY ESTOPPEL OR OTHERWISE, TO ANY INTELLECTUAL PROPERTY RIGHTS IS GRANTED BY THIS DOCUMENT. EXCEPT AS PROVIDED IN INTEL'S TERMS AND CONDITIONS OF SALE FOR SUCH PRODUCTS, INTEL ASSUMES NO LIABILITY WHATSOEVER, AND INTEL DISCLAIMS ANY EXPRESS OR IMPLIED WARRANTY, RELATING TO SALE AND/OR USE OF INTEL PRODUCTS INCLUDING LIABILITY OR WARRANTIES RELATING TO FITNESS FOR A PARTICULAR PURPOSE, MERCHANTABILITY, OR INFRINGEMENT OF ANY PATENT, COPYRIGHT OR OTHER INTELLECTUAL PROPERTY RIGHT. Intel products are not intended for use in medical, life saving, life sustaining applications. Intel may make changes to specifications and product descriptions at any time, without notice.

Intel is a trademark or registered trademark of Intel Corporation or its subsidiaries in the United States and other countries.

\*Other names and brands may be claimed as the property of others.

Copyright © 2009 by Intel Corporation. Portions Copyright 2005-2009 by LSI Corporation. All rights reserved.

# Preface

---

This is the primary hardware guide for the Intel® RAID Controller RS2PI008, for use with the SAS and SATA disk drives. It contains installation instructions and specifications.

For details on how to configure the storage adapters, and for an overview of the software drivers, see the *Intel® RAID Software User's Guide* on the Resource CD.

## Audience

This document assumes that you have some familiarity with RAID controllers and related support devices. The people who benefit from this book are:

- Engineers who are designing an Intel® RAID Controller RS2PI008 for a system.
- Anyone installing an Intel® RAID Controller RS2PI008 in a RAID system.

## Organization

This document includes the following chapters and appendixes:

- Chapter 1 provides a general overview of the Intel® RAID Controller RS2PI008.
- Chapter 2 describes the procedures for installing the RAID controller.
- Chapter 3 provides the characteristics and technical specifications for the Intel® RAID Controller RS2PI008.
- Appendix C explains drive roaming and how to do a drive migration.

## Related Publication

The *Intel® RAID Software User's Guide* is on the Resource CD that ships with the RAID controller.



# Table of Contents

---

<b>Preface</b> .....	<b>iii</b>
Audience .....	iii
Organization .....	iii
Related Publication .....	iii
<b>Chapter 1, Overview</b> .....	<b>1</b>
Benefits of SAS .....	1
Intel® RAID Controller RS2PI008 .....	2
Protocol Support .....	2
Operating System Support .....	2
Usability .....	3
SAS/SATA Features of the LSISAS2108 Controller .....	5
Beep Codes .....	5
<b>Chapter 2, Intel® RAID Controller RS2PI008 Hardware Installation</b> .....	<b>7</b>
Requirements .....	7
Installing the RAID Controller .....	7
Configuring the RAID Controller .....	9
Replacing a Controller .....	9
Resolving a Configuration Mismatch .....	9
<b>Chapter 3, Intel® RAID Controller RS2PI008 Characteristics</b> .....	<b>11</b>
Technical Specifications .....	12
Array Performance Features .....	13
Fault Tolerance .....	14
Safety Characteristics .....	15
<b>A. Installation / Assembly Safety Instructions</b> .....	<b>17</b>
English .....	19
Deutsch .....	20
Français .....	21
Español .....	23
Italiano .....	24
<b>B. Regulatory and Certification Information</b> .....	<b>27</b>
Electromagnetic Compatibility Notices .....	29
<b>C. Drive Roaming and Drive Migration Install</b> .....	<b>31</b>
Drive Roaming .....	31
Drive Migration .....	32



# List of Figures

---

Figure 1. Installing the Intel® RAID Controller RS2PI008 .....	8
Figure 2. Card Layout.....	11





# List of Tables

---

Table 1. Jumper Description .....	11
Table 2. Technical Specifications .....	12
Table 3. Array Performance Features .....	13
Table 4. Fault Tolerance Features .....	14
Table 5. Electrical Characteristics .....	15



# 1 Overview

---

The Intel® RAID Controller RS2PI008 is a high-performance, intelligent PCI Express\* 2.0-compliant SAS/SATA II RAID controller that offers reliability, high performance, and fault-tolerant disk subsystem management. This is a RAID solution that meets the external storage needs of workgroup, department, or enterprise systems to use cost-effective SATA or high-performance SAS media.

As a second-generation PCI Express\* RAID controller, the Intel® RAID Controller RS2PI008 addresses the growing demand for increased data throughput and scalability requirements across mid-range and enterprise-class server platforms.

The RAID controller controls eight external 6-Gb/s SAS/SATA ports through two SFF-8088 x4 Mini SAS connectors and allows the use of expanders to connect up to 240 devices. Note that all expander features will not be available at product launch. For more information about the use of expanders, see the *ANSI SAS Standard Specification, Version 2.0*.

SATA and SAS are serial, point-to-point device interfaces that use simplified cabling, smaller connectors, lower pin counts, and lower power requirements than parallel SCSI.

The optional Intel® RAID Smart Battery AXXRSBBU7 provides cached data protection for the RAID controller, even during system failures.

## Benefits of SAS

SAS is a serial, point-to-point, enterprise-level device interface that leverages the proven SCSI protocol set. SAS is a convergence of the advantages of SATA, SCSI, and Fibre Channel, and is the future mainstay of the enterprise and high-end workstation storage markets. SAS offers a higher bandwidth per pin than parallel SCSI and improves signal and data integrity.

The SAS interface uses the proven SCSI command set to ensure reliable data transfers, while providing the connectivity and flexibility of point-to-point serial data transfers. The serial transmission of SCSI commands eliminates clock skew challenges. The SAS interface provides improved performance, simplified cabling, smaller connectors, lower pin count, and lower power requirements than parallel SCSI.

SAS controllers leverage a common electrical and physical connection interface that is compatible with Serial ATA technology. The SAS and SATA protocols use a thin, 7-wire connector instead of the 68-wire SCSI cable or 40-wire ATA cable. The SAS/SATA connector and cable are easier to manipulate, connect to smaller devices, and do not inhibit airflow. The point-to-point SATA architecture eliminates difficulties created by the legacy ATA master-slave architecture while maintaining compatibility with existing ATA firmware.

# Intel® RAID Controller RS2PI008

The Intel® RAID Controller RS2PI008 is an intelligent, low-profile RAID adapter with an integrated LSI SAS2108 RAID-On-Chip chipset, providing both a SAS controller and RAID engine. With 512-MB RAM built onto the board and eight independent ports supporting 6Gb/s and 3Gb/s SAS data transfers using two SFF-8088 mini multi-lane connectors, this controller supports up to 240 enterprise-class SAS or SATA devices and 64 virtual drives. The PCI Express\* connector fits into an x8 or x16 PCI Express\* slot capable of performance up to 5 Gb/s per lane.

The SAS RAID controllers support the SAS protocol as described in the *Serial Attached SCSI Standard, Version 2.0*. The controllers also support the Serial ATA II (SATA II) protocol defined by the *Serial ATA Specification, Version 1.0a* and the *Serial ATA II: Extension to the Serial ATA Specification, Version 1.1*. SATA II is an extension to SATA 1.0a.

In addition, the SAS RAID controllers support the following SATA II features:

- 3Gb/s SATA II
- Staggered spin-up
- Hot plug
- Native command queuing
- Activity and fault indicators for each PHY
- Port selector (for dual-port drives)

## Protocol Support

Each port on the SAS controllers supports SAS devices, SATA II devices, or both using SSP, SMP, STP, and SATA II as follows:

- Serial SCSI Protocol (SSP) to enable communication with other SAS devices.
- SATA II Protocol to enable communication with other SATA II devices.
- Serial Management Protocol (SMP) to share topology management information with expanders.
- Serial Tunneling Protocol (STP) support for SATA II through expander interfaces.

## Operating System Support

- Microsoft Windows Server 2003\*, Microsoft Windows Server 2008\*, and Windows Vista\*.
- Red Hat\* Enterprise Linux 4.0, and 5.0.
- SuSE\* Linux Enterprise Server 10 and 11.

All operating systems supported by the RAID controller may not be supported by your server board. To verify compatibility, see the *Tested Operating System List* for your server board at <http://support.intel.com/support/motherboards/server/>.

To make sure the RAID controller supports your operating system, refer to the *Tested Hardware and Operating System List* for the Intel® RAID Controller RS2PI008.

## Usability

- The card ships with both a standard and a low-profile bracket.
- Upto 6.0 Gb/s serial, point-to-point data transfer rates
- Support for non-disk devices and mixed capacity drives
- Support for intelligent XOR RAID levels 0, 1, 5, 6, 10, 50, and 60
- Dedicated or global hot spare with auto rebuild if an array drive fails
- User-defined stripe size per drive: 8, 16, 32, 64, 128, 256, 512, or 1024 KB
- Advanced Array configuration and Management Utilities provides:
  - Online Capacity Expansion (OCE) adds space to existing drive or new drive. See Appendix A for limitations on OCE and RAID migration.
  - Online RAID level migration (upgrade of RAID mode may require OCE).
  - Drive migration
  - Drive roaming
  - No reboot necessary after expansion
  - Load Balancing
- Upgradeable Flash ROM interface
- Allows for staggered spin up, hot-plug, and lower power consumption
- User-specified rebuild rate (percent of system resources to use from 0-100%)

**Caution:** *Exceeding 50% rate may cause operating system errors due to waiting for controller access.*

- Background operating mode can be set for Rebuilds, Consistency Checks, Initialization (auto restarting Consistency Check on redundant volumes), Migration, OCE, and Patrol Read.
- Allows mixed connections to SAS targets or SATA II targets

**Note:** *Intel recommends that you carefully assess any decision to mix SAS and SATA drives within the same virtual drive. Although you can mix drives within the same virtual drive, Intel strongly discourages the practice. However, you should never mix SAS and SATA drives within the same enclosure.*

## Redundancy and Error Handling

- In-band SES2.
- Enclosure management support.
- Drive coercion (auto-resizing to match existing disks).
- Auto-detection of failed drives with transparent rebuild. There must be disk activity (I/O to the drive) for a missing drive to be marked as failed.
- Auto-resume on reboot of initialization or rebuild (must be enabled before virtual disk creation).
- Smart initialization automatically checks consistency of virtual disks if there are five or more disks in a RAID 5 array, which optimizes performance by enabling read-modify-write mode. RAID 5 arrays of only three or four drives use Peer Read mode.
- Dirty cache LED plus error reporting for cache write to disk.
- Smart Technology predicts failures of drives and electronic components.
- Patrol Read checks drives and maps bad sectors.
- Commands are retried at least four times.
- Firmware provides best effort to recognize an error and recover if possible.
- Failures are logged from controller and drive firmware, and SMART monitor.
- Failures are logged in NVRAM, viewable from OS Event Log, Intel® RAID Web Console 2; CIM, LEDs, and via alarm.
- Multiple cache options allow configuration-specific performance optimization:
  - Write-back: Faster because it does not wait for the disk but data will be lost if power is lost.
  - Write-through: Usually slower but ensures data is on the disk.
  - Read Ahead: Predicts next read will be sequential and buffers this data into the cache.
  - Non-Read Ahead: Always reads from the drive after determining exact location of each read.
  - Adaptive Read Ahead: Reads ahead and caches data only if doing sequential reads.
  - I/O setting: Determines whether read operations check the cache before reading from disks.
    - ✧ Cache I/O: Checks cache first; only reads disk if data is not in the cache.
    - ✧ Direct I/O: Reads data directly from disk (not cache).
- Redundancy through:
  - Configuration stored in non-volatile RAM and on the drives (COD).
  - Hot-swap support.
  - Optional battery backup for cache memory.

## SAS/SATA Features of the LSISAS2108 Controller

- Provides eight independent phys, each supporting 6Gb/s and 3Gb/s SAS data transfers per PHY.
- Scalable interface that supports up to 240 physical devices via expanders.
- Supports SSP to enable communication with other SAS devices.
- Supports SMP to communicate topology management information.
- Supports single PHY or wide ports consisting of 2, 3, or 4 PHYs within a single quad port.
- Allows addressing of multiple SATA targets through an expander if using SATA 2.0-compliant hard disk drives.
- Allows multiple initiators to address a single target (in a fail-over configuration) through an expander.

*Note:* All expander features will not be available at launch.

## Online Capacity Expansion and RAID Level Migration Rules

- Migration must occur to the same or larger capacity configuration.
- Migration cannot occur if there is more than one virtual disk in an array.
- Migration and OCE cannot be done on Spanned Arrays (RAID 10, 50, 60).
- Migrations supported are RAID 1 to RAID 0, RAID 5 to RAID 0, RAID 6 to RAID 5, and RAID 6 to RAID 0.
- With OCE, migrations supported are RAID 0 to RAID 1, RAID 0 to RAID 5, RAID 5 to RAID 6, RAID 1 to RAID 6, and RAID 1 to RAID 5.

## Beep Codes

- Short beep (1 second on, 1 second off): Array has degraded but no data has been lost.
- Long beep (3 seconds on, 1 second off): Array has failed and data has been lost.
- Short beep (1 second on, 3 seconds off): Using hot spare in rebuild; alarm will continue during rebuild with a different sound at completion.

To disable the alarm, choose Disable Alarm. To enable the alarm, choose Enable Alarm

To disable the alarm only until the next event or until next power cycle, choose Silence Alarm.





# 2 Intel® RAID Controller RS2PI008 Hardware Installation

---

## Requirements

- An Intel® RAID Controller RS2PI008
- A host system with an available x8 or x16 PCI-Express\* slot
- The Resource CD, which contains drivers and documentation
  - Note:* The Resource CD will not be shipped with the product at launch, but the files will be made available on Intel's support web site at <http://support.intel.com/support/motherboards/server/>.
- SAS or SATA 3.0 hard drives
  - Note:* SATA II is the only type of SATA supported by this RAID Controller.

In addition, Intel Corporation strongly recommends using an uninterruptible power supply (UPS).

## Installing the RAID Controller

To install the RAID Controller, follow these steps:

1. Turn off the power to the system, all drives, enclosures, and system components. Remove the power cord(s).
2. Remove the server system cover. For instructions, see the server system documentation.
3. If necessary, change the bracket on the RAID controller to fit the height of the server system.
4. Install the RAID controller into an available server system x8 or x16 PCI-Express\* slot (see [Figure 1](#)). To locate an appropriate slot and for instructions on installing an add-in card, see your server system documentation.

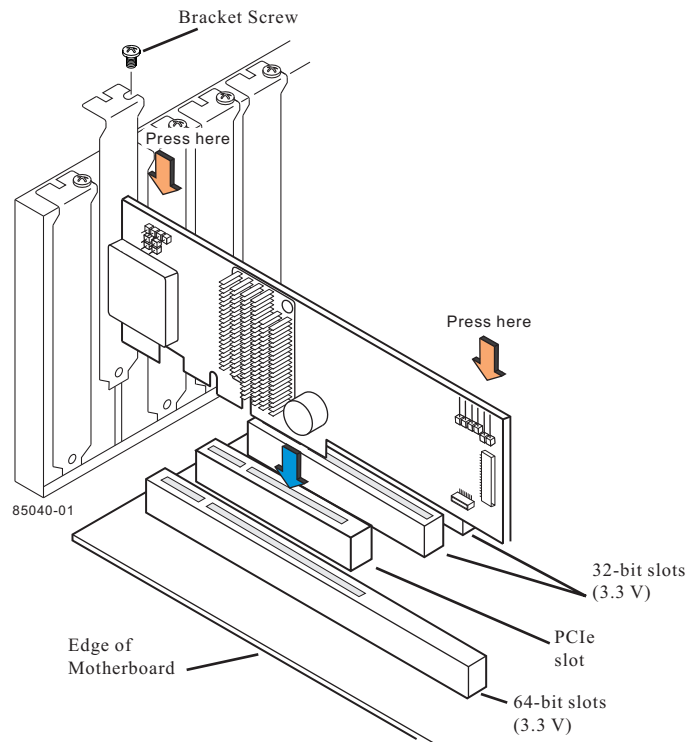

**Figure 1. Installing the Intel® RAID Controller RS2PI008**

5. Configure and install the SAS Devices, SATA II Devices, or both in the target external storage case. Refer to the documentation of the devices for any preinstallation configuration requirements.
6. Use SAS cables to connect the RAID controller to the target external storage case.
7. Install the server system cover and connect the power cords. For instructions, see your server system documentation.

## Configuring the RAID Controller

To configure the RAID Controller, follow these steps:

1. Turn on the system power and listen to be sure that the SATA devices power up before or at the same time as the system.
2. During the boot, a BIOS message displays to state the keys to press to enter the Intel® RAID BIOS Console 2, such as  
`Press <CTRL><G> to run BIOS Console 2.`  
This message times out after several seconds. If you miss it, you need to restart the system.  
After you press the keys to enter the Intel® RAID BIOS Console 2 software, the firmware takes several seconds to initialize and then display the Intel® RAID Controller RS2PI008 number and firmware version. The numbering of the RAID controller follows the PCI slot scanning order used by the server board.
3. See the *Quick Start User's Guide* and the *Software User's Guide* for instructions to configure the RAID controller and to install the operating system drivers.

## Replacing a Controller

To replace the RAID controller, see your server system documentation for instructions to remove and then install an add-in adapter.

## Resolving a Configuration Mismatch

If the newly installed RAID controller was previously configured, a message displays during POST, stating that there is a configuration mismatch because the configuration data in the NVRAM differs from that in the hard drives. Use these steps to resolve the mismatch:

1. Press <Ctrl> + <G> when prompted during boot up to access the BIOS Configuration Utility.
2. Select Configure > View/Add Configuration to see the NVRAM and drive configurations.
3. Since the drives contain the correct configuration, use configuration from the disks.
4. Press <Esc> and select YES to update the NVRAM.
5. Exit and reboot.



# 3 Intel® RAID Controller RS2PI008 Characteristics

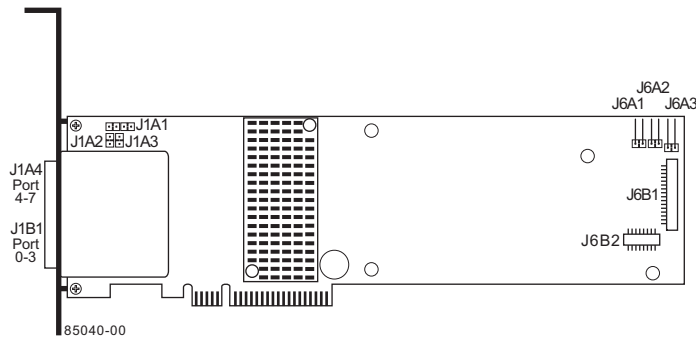

Figure 2. Card Layout

Table 1. Jumper Description

Jumper	Description	Type	Comments
J1A1	Universal Asynchronous Receiver/Transmitter (UART)	4-pin connector	For factory and debug use
J1A2	Test header	2-pin connector	Reserved for factory use only
J1A3	Set Factory Defaults Connector	2-pin connector	Resets the board settings to the defaults set in the factory
J1A4	External Mini SAS 4i Connector, Ports 4-7	SFF8088	Connection to SAS/SATA devices
J1B1	External Mini SAS 4i Connector, Ports 0-3	SFF8088	Connection to SAS/SATA devices
J6A1	Drive Fault LED Header	2-pin connector	LED signal for any drive fault
J6A2	Drive Activity LED Header	2-pin connector	LED signal for drive activity
J6A3	Dirty Cache LED Header	2-pin connector	For connection to enclosure LED. When lit, indicates the data in the cache has not been written to disk
J6B1	Remote Battery Backup Unit Connector	20-pin connector	Provides an interface to the remote battery backup unit
J6B2	Board-to-board Connector for Battery Backup Unit	20-pin connector	Provides an interface to the daughter card that contains the battery backup unit.

# Technical Specifications

**Table 2. Technical Specifications**

<b>Specification</b>	<b>Intel® RAID Controller RS2PI008</b>
RAID-on-Chip (ROC )	LSISAS2108 Integrated ROC, 800 MHz
Operating voltage	+3.3 V, +12 V
Card size	Low profile, extended half-length (6.6-inch, MD2)
Array interface to host	PCI Express* Revision 2.0, x8 lane width 5.0 Gb/s
SAS/SATA bus speed	Up to 6 Gb/s per port, point-to-point
SAS/SATA ports	2x4 external ports
Physical and virtual drive support	240 physical drives, 64 virtual drives, and 128 RAID arrays per controller
Cache	512 MB DDR2 800 MHz SDRAM, optional battery backup
Firmware	8 MB in reflashable flash ROM
Compatible devices	<ul style="list-style-type: none"><li>• 2.5-inch and 3.5-inch SAS or SATA II drives</li><li>• Non disk devices including expanders</li><li>• Can support drives of mixed capacity</li></ul>
Cabling	Shared connectors for multiple drives
Redundant configuration	32 KB NVRAM and config-on-disk (COD)
Enclosure management	In-band SES
Enclosure support	Assumes one SEP per enclosure

# Array Performance Features

**Table 3. Array Performance Features**

Specification	Intel® RAID Controller RS2PI008
Host data transfer rate	Up to 5.0 Gb/s per PCI Express* lane
Drive data transfer rate	Up to 6.0 Gb/s per phy
Maximum scatter / gather	80 elements
Maximum size of I/O requests	6.4 Mbytes in 64 Kbyte stripes
Maximum queue tags per drive	As many as the drive can accept
Stripe sizes	8, 16, 32, 64, 128, 256, 512, or 1024 KB
Maximum concurrent commands	1024-16
Support for multiple initiators	Yes
Performance	Native command queuing
Flexibility	<ul style="list-style-type: none"> <li>• Drive migration</li> <li>• RAID level migration</li> <li>• Drive Roaming</li> <li>• Online Capacity Expansion - without reboot</li> </ul>
Background services	<ul style="list-style-type: none"> <li>• Rebuild</li> <li>• Consistency Check</li> <li>• Migration</li> <li>• OCE</li> <li>• Patrol Read</li> </ul>
Cache options	<ul style="list-style-type: none"> <li>• Write-back or Write-through</li> <li>• Read Ahead, Adaptive Read Ahead, or Non-Read Ahead</li> <li>• Cache I/O or Direct I/O</li> </ul>

## Fault Tolerance

**Table 4. Fault Tolerance Features**

Specification	Intel® RAID Controller RS2PI008
Self Monitoring Analysis and Reporting Technology (SMART) support	<ul style="list-style-type: none"> <li>• Detects up to 70% of predictable disk drive failures</li> <li>• Monitors the internal performance of all motors, heads, and drive electronics.</li> </ul>
Optional Battery Backup	<ul style="list-style-type: none"> <li>• Intel® RAID Smart Battery AXRSBBU7 cache backup</li> <li>• Up to 72 hours of data retention, "Gas Gauge".</li> </ul>
Drive Replacement	<ul style="list-style-type: none"> <li>• Auto detection of failure</li> <li>• Hot plug</li> <li>• Hot swap</li> </ul>
Drive Rebuild Using Hot Spares	<ul style="list-style-type: none"> <li>• Automatic at fail</li> <li>• Dedicated per array</li> <li>• Global for any array</li> <li>• Auto-resume of initialization or rebuild on reboot</li> </ul>
Error Checking and Indication	<ul style="list-style-type: none"> <li>• Parity generation and checking, automatic consistency checking</li> <li>• Patrol reads</li> <li>• Activity and fault LEDs, alarm</li> <li>• Multiple retries</li> <li>• Logs in NVRAM, event log, CIM, Smart, Intel® RAID Web Console 2</li> </ul>



## Electrical Characteristics

**Table 5. Electrical Characteristics**

<b>Characteristic</b>	<b>Values</b>
PCI +12 V	1.0A
PCI +3.3 Aux	30 mA
PCI +3.3 V	773 mA
Temperature	
Non-operating	-30°C to +80°C without the optional battery / 0°C to 45°C with the optional battery
Operating	0°C to 60°C without the optional battery / 0°C to 45°C with the optional battery
Relative Humidity	
Operating	5%-90% non-condensing ( 20%-80% non-condensing for the RAID controllers)
Airflow	> 200 linear feet per minute (LFPM)

## Safety Characteristics

The Intel® RAID Controller RS2PI008 meets or exceeds the requirements of UL flammability rating 94 V0. Each bare board is marked with the supplier name or trademark, type, and UL flammability rating. For the boards installed in a PCI bus slot, all voltages are lower than the SELV 42.4 V limit.



# Appendix A: Installation / Assembly Safety Instructions

---

## **As you use your computer system, observe these safety guidelines:**

- Do not operate your computer system with any cover(s) (such as computer covers, bezels, filler brackets, and front panel inserts) removed.
- To help avoid damaging your computer, be sure the voltage selection switch on the power supply is set to match the alternating current (AC) power available at your location.
- To help avoid possible damage to the server board, wait five seconds after turning off the system before removing a component from the server board or disconnecting a peripheral device from the computer.
- To help prevent electric shock, plug the computer and peripheral power cables into properly grounded power sources. These cables are equipped with 3-prong plugs to ensure proper grounding. Do not use adapter plugs or remove the grounding prong from a cable. If you must use an extension cable, use a 3-wire cable with properly grounded plugs.
- To help protect your computer system from sudden, transient increases and decreases in electrical power, use a surge suppressor, line conditioner, or uninterruptible power supply.
- Be sure nothing rests on your computer system's cables and that the cables are not located where they can be stepped on or tripped over.
- Do not spill food or liquids on your computer. If the computer gets wet, consult the documentation that came with it.
- Do not push any objects into the openings of your computer. Doing so can cause fire or electric shock by shorting out interior components.
- Keep your computer away from radiators and heat sources. Also, do not block cooling vents. Avoid placing loose papers underneath your computer; do not place your computer in a closed-in wall unit or on a rug.

## **When working inside your computer:**

- Do not attempt to service the computer system yourself, except as explained in this guide and elsewhere in Intel documentation. Always follow installation and service instructions closely.
- Turn off your computer and any peripherals.
- Disconnect your computer and peripherals from their power sources. Also disconnect any telephone or telecommunications lines from the computer.

Doing so reduces the potential for personal injury or shock.

**Additional safety guidelines:**



- When you disconnect a cable, pull on its connector or on its strain-relief loop, not on the cable itself. Some cables have a connector with locking tabs; if you are disconnecting this type of cable, press in on the locking tabs before disconnect the cable. As you pull connectors apart, keep them evenly aligned to avoid bending any connector pins. Also, before you connect a cable, make sure both connectors are correctly oriented and aligned.
- Handle components and cards with care. Do not touch the components or contacts on a card. Hold a card by its edges or by its metal mounting bracket. Hold a component such as a microprocessor chip by its edges, not by its pins.

**Protecting against electrostatic discharge**

- Static electricity can harm delicate components inside your computer. To prevent static damage, discharge static electricity from your body before you touch any of your computer's electronic components, such as the microprocessor. You can do so by touching an unpainted metal surface, such as the metal around the card-slot openings at the back of the computer.
- As you continue to work inside the computer, periodically touch an unpainted metal surface to remove any static charge your body may have accumulated. In addition to the preceding precautions, you can also take the following steps to prevent damage from electrostatic discharge (ESD).
- When unpacking a static-sensitive component from its shipping carton, do not remove the component from the antistatic packing material until you are ready to install the component in your computer. Just before unwrapping the antistatic packaging, be sure to discharge static electricity from your body.
- When transporting a sensitive component, first place it in an antistatic container or packaging.
- Handle all sensitive components in a static-safe area. If possible, use antistatic floor pads and workbench pads.

# English

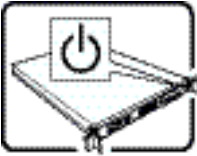
Read all caution and safety statements in this document before performing any of the instructions. See also *Intel® Server Boards and Server Chassis Safety Information* on the Resource CD and/or at <http://support.intel.com/support/motherboards/server/sb/cs-010770.htm>.

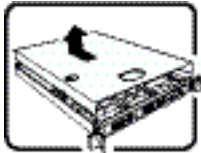
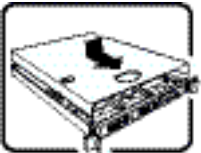
	<p>The power button on the system does not turn off system AC power. To remove AC power from the system, you must unplug each AC power cord from the wall outlet or power supply.</p> <p>The power cord(s) is considered the disconnect device to the main (AC) power. The socket outlet that the system plugs into shall be installed near the equipment and shall be easily accessible.</p>
	<p><b>SAFETY STEPS:</b> Whenever you remove the chassis covers to access the inside of the system, follow these steps:</p> <ol style="list-style-type: none"> <li>1. Turn off all peripheral devices connected to the system.</li> <li>2. Turn off the system by pressing the power button.</li> <li>3. Unplug all AC power cords from the system or from wall outlets.</li> <li>4. Label and disconnect all cables connected to I/O connectors or ports on the back of the system.</li> <li>5. Provide some electrostatic discharge (ESD) protection by wearing an antistatic wrist strap attached to chassis ground of the system-any unpainted metal surface-when handling components.</li> <li>6. Do not operate the system with the chassis covers removed.</li> </ol>
	<p>After you have completed the six SAFETY steps above, you can remove the system covers. To do this:</p> <ol style="list-style-type: none"> <li>1. Unlock and remove the padlock from the back of the system if a padlock has been installed.</li> <li>2. Remove and save all screws from the covers.</li> <li>3. Remove the cover(s).</li> </ol>
	<p>For proper cooling and airflow, always reinstall the chassis covers before turning on the system. Operating the system without the covers in place can damage system parts. To install the covers:</p> <ol style="list-style-type: none"> <li>1. Check first to make sure you have not left loose tools or parts inside the system.</li> <li>2. Check that cables, add-in cards, and other components are properly installed.</li> <li>3. Attach the covers to the chassis with the screws removed earlier, and tighten them firmly.</li> <li>4. Insert and lock the padlock to the system to prevent unauthorized access inside the system.</li> <li>5. Connect all external cables and the AC power cord(s) to the system.</li> </ol>

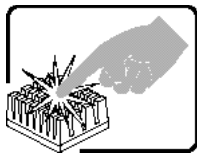

A microprocessor and heat sink may be hot if the system has been running. Also, there may be sharp pins and edges on some board and chassis parts. Contact should be made with care. Consider wearing protective gloves.

## Deutsch

Lesen Sie zunächst sämtliche Warn- und Sicherheitshinweise in diesem Dokument, bevor Sie eine der Anweisungen ausführen. Beachten Sie hierzu auch die *Sicherheitshinweise zu Intel-Serverplatinen und -Servergehäusen* auf der Ressourcen-CD oder unter <http://support.intel.com/support/motherboards/server/sb/cs-010770.htm>.

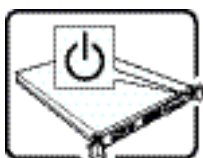

Der Wechselstrom des Systems wird durch den Ein-/Aus-Schalter für Gleichstrom nicht ausgeschaltet. Ziehen Sie jedes Wechselstrom-Netzkabel aus der Steckdose bzw. dem Netzgerät, um den Stromanschluß des Systems zu unterbrechen.

Die Stromkabel sind das "Unterbrechungsgerät" zur Hauptstromquelle. Die Steckdose, in die das System gesteckt wird, sollte sich in der Nähe des Gerätes befinden und leicht zugänglich sein.



**SICHERHEITSMASSNAHMEN:** Immer wenn Sie die Gehäuseabdeckung abnehmen um an das Systeminnere zu gelangen, sollten Sie folgende Schritte beachten:

1. Schalten Sie alle an Ihr System angeschlossenen Peripheriegeräte aus.
2. Schalten Sie das System mit dem Hauptschalter aus.
3. Ziehen Sie den Stromanschlußstecker Ihres Systems aus der Steckdose.
4. Auf der Rückseite des Systems beschrifteten und ziehen Sie alle Anschlußkabel von den I/O Anschlüssen oder Ports ab.
5. Tragen Sie ein geerdetes Antistatik Gelenkband, um elektrostatische Ladungen (ESD) über blanke Metallstellen bei der Handhabung der Komponenten zu vermeiden.
6. Schalten Sie das System niemals ohne ordnungsgemäß montiertes Gehäuse ein.

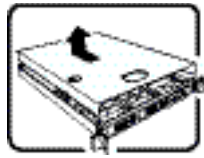

SICHERHEITSMASSNAHMEN: Immer wenn Sie die Gehäuseabdeckung abnehmen um an das Systeminnere zu gelangen, sollten Sie folgende Schritte beachten:

1. Schalten Sie alle an Ihr System angeschlossenen Peripheriegeräte aus.
2. Schalten Sie das System mit dem Hauptschalter aus.
3. Ziehen Sie den Stromanschlußstecker Ihres Systems aus der Steckdose.
4. Auf der Rückseite des Systems beschrifteten und ziehen Sie alle Anschlußkabel von den I/O Anschlüssen oder Ports ab.
5. Tragen Sie ein geerdetes Antistatik Gelenkband, um elektrostatische Ladungen (ESD) über blanke Metallstellen bei der Handhabung der Komponenten zu vermeiden.
6. Schalten Sie das System niemals ohne ordnungsgemäß montiertes Gehäuse ein.

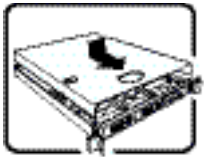

Zur ordnungsgemäßen Kühlung und Lüftung muß die Gehäuseabdeckung immer wieder vor dem Einschalten installiert werden. Ein Betrieb des Systems ohne angebrachte Abdeckung kann Ihrem System oder Teile darin beschädigen. Um die Abdeckung wieder anzubringen:

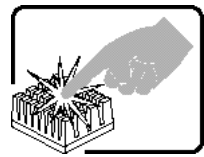

1. Vergewissern Sie sich, daß Sie keine Werkzeuge oder Teile im Innern des Systems zurückgelassen haben.
2. Überprüfen Sie alle Kabel, Zusatzkarten und andere Komponenten auf ordnungsgemäßen Sitz und Installation.
3. Bringen Sie die Abdeckungen wieder am Gehäuse an, indem Sie die zuvor gelösten Schrauben wieder anbringen. Ziehen Sie diese gut an.
4. Bringen Sie die Verschlusseinrichtung (Padlock) wieder an und schließen Sie diese, um ein unerlaubtes Öffnen des Systems zu verhindern.
5. Schließen Sie alle externen Kabel und den AC Stromanschlußstecker Ihres Systems wieder an.



Der Mikroprozessor und der Kühler sind möglicherweise erhitzt, wenn das System in Betrieb ist. Außerdem können einige Platinen und Gehäuseteile scharfe Spitzen und Kanten aufweisen. Arbeiten an Platinen und Gehäuse sollten vorsichtig ausgeführt werden. Sie sollten Schutzhandschuhe tragen.

## Français

Lisez attention toutes les consignes de sécurité et les mises en garde indiquées dans ce document avant de suivre toute instruction. Consultez *Intel® Server Boards and Server Chassis Safety Information* sur le CD Resource CD ou bien rendez-vous sur le site <http://support.intel.com/support/motherboards/server/sb/cs-010770.htm>

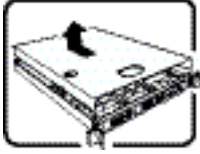
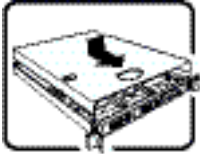
	<p>Notez que le commutateur CC de mise sous tension /hors tension du panneau avant n'éteint pas l'alimentation CA du système. Pour mettre le système hors tension, vous devez débrancher chaque câble d'alimentation de sa prise.</p> <p>C'est le câble d'alimentation qui est considéré comme le moyen de se déconnecter du CA. La prise à laquelle le système est branché doit se situer à proximité de l'équipement et être facilement accessible.</p>
	<p><b>CONSIGNES DE SÉCURITÉ</b> -Lorsque vous ouvrez le boîtier pour accéder à l'intérieur du système, suivez les consignes suivantes:</p> <ol style="list-style-type: none"> <li>1. Mettez hors tension tous les périphériques connectés au système.</li> <li>2. Mettez le système hors tension en mettant l'interrupteur général en position OFF (bouton-poussoir).</li> <li>3. Débranchez tous les cordons d'alimentation c.a. du système et des prises murales.</li> <li>4. Identifiez et débranchez tous les câbles reliés aux connecteurs d'E-S ou aux accès derrière le système.</li> <li>5. Pour prévenir les décharges électrostatiques lorsque vous touchez aux composants, portez une bande antistatique pour poignet et reliez-la à la masse du système (toute surface métallique non peinte du boîtier).</li> <li>6. Ne faites pas fonctionner le système tandis que le boîtier est ouvert.</li> </ol>
	<p>Une fois TOUTES les étapes précédentes accomplies, vous pouvez retirer les panneaux du système. Procédez comme suit:</p> <ol style="list-style-type: none"> <li>1. Si un cadenas a été installé sur à l'arrière du système, déverrouillez-le et retirez-le.</li> <li>2. Retirez toutes les vis des panneaux et mettez-les dans un endroit sûr.</li> <li>3. Retirez les panneaux.</li> </ol>
	<p>Afin de permettre le refroidissement et l'aération du système, réinstallez toujours les panneaux du boîtier avant de mettre le système sous tension. Le fonctionnement du système en l'absence des panneaux risque d'endommager ses pièces. Pour installer les panneaux, procédez comme suit:</p> <ol style="list-style-type: none"> <li>1. Assurez-vous de ne pas avoir oublié d'outils ou de pièces démontées dans le système.</li> <li>2. Assurez-vous que les câbles, les cartes d'extension et les autres composants sont bien installés.</li> <li>3. Revissez solidement les panneaux du boîtier avec les vis retirées plus tôt.</li> <li>4. Remettez le cadenas en place et verrouillez-le afin de prévenir tout accès non autorisé à l'intérieur du système.</li> <li>5. Rebranchez tous les cordons d'alimentation c. a. et câbles externes au système.</li> </ol>



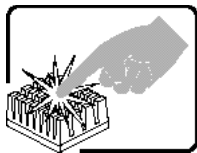

Le microprocesseur et le dissipateur de chaleur peuvent être chauds si le système a été sous tension. Faites également attention aux broches aiguës des cartes et aux bords tranchants du capot. Nous vous recommandons l'usage de gants de protection.

## Español

Lea todas las declaraciones de seguridad y precaución de este documento antes de realizar cualquiera de las instrucciones. Vea *Intel® Server Boards and Server Chassis Safety Information* en el CD Resource y/o en <http://support.intel.com/support/motherboards/server/sb/cs-010770.htm>

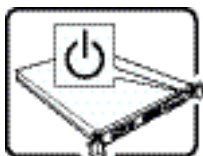

Nótese que el interruptor activado / desactivado en el panel frontal no desconecta la corriente alterna del sistema. Para desconectarla, deberá desenchufar todos los cables de corriente alterna de la pared o desconectar la fuente de alimentación.

Estos cables actúan como dispositivo de desconexión. La toma de corriente deberá estar situada cerca del equipo y ser de fácil acceso.



**INSTRUCCIONES DE SEGURIDAD:** Cuando extraiga la tapa del chasis para acceder al interior del sistema, siga las siguientes instrucciones:

1. Apague todos los dispositivos periféricos conectados al sistema.
2. Apague el sistema presionando el interruptor encendido / apagado.
3. Desconecte todos los cables de alimentación CA del sistema o de las tomas de corriente alterna.
4. Identifique y desconecte todos los cables enchufados a los conectores E/S o a los puertos situados en la parte posterior del sistema.
5. Cuando manipule los componentes, es importante protegerse contra la descarga electrostática (ESD). Puede hacerlo si utiliza una muñequera antiestática sujeta a la toma de tierra del chasis - o a cualquier tipo de superficie de metal sin pintar.
6. No ponga en marcha el sistema si se han extraído las tapas del chasis.

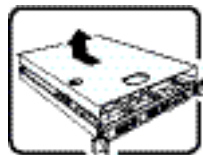

Después de completar las seis instrucciones de SEGURIDAD mencionadas, ya puede extraer las tapas del sistema. Para ello:

1. Desbloquee y extraiga el bloqueo de seguridad de la parte posterior del sistema, si se ha instalado uno.
2. Extraiga y guarde todos los tornillos de las tapas. Extraiga las tapas.

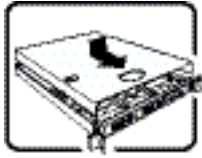

Para obtener un enfriamiento y un flujo de aire adecuados, reinstale siempre las tapas del chasis antes de poner en marcha el sistema. Si pone en funcionamiento el sistema sin las tapas bien colocadas puede dañar los componentes del sistema. Para instalar las tapas:

1. Asegúrese primero de no haber dejado herramientas o componentes sueltos dentro del sistema.
2. Compruebe que los cables, las placas adicionales y otros componentes se hayan instalado correctamente.
3. Incorpore las tapas al chasis mediante los tornillos extraídos anteriormente, tensándolos firmemente.
4. Inserte el bloqueo de seguridad en el sistema y bloquéelo para impedir que pueda accederse al mismo sin autorización.
5. Conecte todos los cables externos y los cables de alimentación CA al sistema.

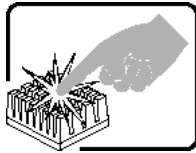

Si el sistema ha estado en funcionamiento, el microprocesador y el disipador de calor pueden estar aún calientes. También conviene tener en cuenta que en el chasis o en el tablero puede haber piezas cortantes o punzantes. Por ello, se recomienda precaución y el uso de guantes protectores.

## Italiano

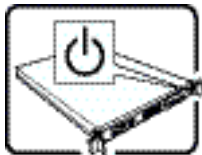

L'interruttore attivato / disattivato nel pannello anteriore non interrompe l'alimentazione in c.a. del sistema. Per interromperla, è necessario scollegare tutti i cavi di alimentazione in c.a. dalle prese a muro o dall'alimentazione di corrente.

Il cavo è considerato il dispositivo d'interruzione dell'alimentazione principale (in c.a.). La presa alla quale si collega il sistema deve essere installata vicino all'unità e deve essere facilmente accessibile.

	<p><b>PASSI DI SICUREZZA:</b> Qualora si rimuovano le coperture del telaio per accedere all'interno del sistema, seguire i seguenti passi:</p> <ol style="list-style-type: none"> <li>1. Spegner tutti i dispositivi periferici collegati al sistema.</li> <li>2. Spegner il sistema, usando il pulsante spento / acceso dell'interruttore del sistema.</li> <li>3. Togliere tutte le spine dei cavi del sistema dalle prese elettriche.</li> <li>4. Identificare e sconnettere tutti i cavi attaccati ai collegamenti I/O od alle prese installate sul retro del sistema.</li> <li>5. Qualora si tocchino i componenti, proteggersi dallo scarico elettrostatico (SES), portando un cinghia anti-statica da polso che è attaccata alla presa a terra del telaio del sistema - qualsiasi superficie non dipinta - .</li> <li>6. Non far operare il sistema quando il telaio è senza le coperture.</li> </ol>
	<p>Dopo aver seguito i sei passi di SICUREZZA sopracitati, togliere le coperture del telaio del sistema come segue:</p> <ol style="list-style-type: none"> <li>1. Aprire e rimuovere il lucchetto dal retro del sistema qualora ve ne fosse uno installato.</li> <li>2. Togliere e mettere in un posto sicuro tutte le viti delle coperture.</li> <li>3. Togliere le coperture.</li> </ol>
	<p>Per il giusto flusso dell'aria e raffreddamento del sistema, rimettere sempre le coperture del telaio prima di riaccendere il sistema. Operare il sistema senza le coperture al loro proprio posto potrebbe danneggiare i componenti del sistema. Per rimettere le coperture del telaio:</p> <ol style="list-style-type: none"> <li>1. Controllare prima che non si siano lasciati degli attrezzi o dei componenti dentro il sistema.</li> <li>2. Controllare che i cavi, dei supporti aggiuntivi ed altri componenti siano stati installati appropriatamente.</li> <li>3. Attaccare le coperture al telaio con le viti tolte in precedenza e avvitarle strettamente.</li> <li>4. Inserire e chiudere a chiave il lucchetto sul retro del sistema per impedire l'accesso non autorizzato al sistema.</li> <li>5. Ricollegare tutti i cavi esterni e le prolunghie AC del sistema.</li> </ol>
	<p>Se il sistema è stato a lungo in funzione, il microprocessore e il dissipatore di calore potrebbero essere surriscaldati. Fare attenzione alla presenza di piedini appuntiti e parti taglienti sulle schede e sul telaio. È consigliabile l'uso di guanti di protezione.</p>



# Appendix B: Regulatory and Certification Information

---

This RAID Controller Card complies with the following safety and electromagnetic compatibility (EMC) regulations.

## Product Safety Compliance

- UL 1950 - CSA 950 (US/Canada)
- EN 60 950 (European Union)
- IEC60 950 (International)
- CE - Low Voltage Directive (2006/95/EEC) (European Union)

## Product EMC Compliance - Class A







- FCC / ICES-003 (USA/Canada)
- CISPR 22 (International)
- EN55022 (Europe)
- EN55024 (Europe)
- CE - EMC Directive 2004/108//EEC (Europe)
- VCCI (Japan) - Verification Only
- AS/NZS 3548 (Australia / New Zealand)
- BSMI CNS13438 (Taiwan)
- KCC Certification (Korea)

## Product Regulatory Compliance Markings

The RAID Controller Card is with the following compliance markings. Some marking information may be provided on the packaging and/or in the product documentation due to limited marking space on the product. Some markings and warnings may be provided in the literature if no room was deemed on product for marking.

- ETL or NRTL Mark (US/Canada)
- FCC (US)
- ICES-003 (Canada)
- CE Mark (Europe)
- KCC Mark (Korea)

- BSMI DOC Mark (Taiwan)
- ACS C-Tick Mark (Australia)

Regulatory Compliance	Country	Marking
NRTL Certification Marking	USA/Canada	 OR 
CE Mark	Europe	
FCC Marking (Class A)	USA	This device complies with Part 15 of the FCC Rules. Operation of this device is subject to the following two conditions: (1) This device may not cause harmful interference, and (2) This device must accept any interference received, including interference that may cause undesired operation.
EMC Marking (Class A)	Canada	CANADA ICES-003 CLASS A CANADA NMB-003 CLASSE A
BSMI Marking (Class A) and Class A EMC Warning	Taiwan	 警告使用者： 這是甲類的資訊產品，在居住的環境中使用時，可能會造成射頻干擾，在這種情況下，使用者會被要求採取某些適當的對策
KCC Mark	Korea	
C-Tick Mark	Australia	

# Electromagnetic Compatibility Notices

FCC Verification Statement (USA) :

This device complies with Part 15 of the FCC Rules. Operation is subject to the following two conditions: (1) This device may not cause harmful interference, and (2) this device must accept any interference received, including interference that may cause undesired operation.

Intel Corporation  
5200 N.E. Elam Young Parkway  
Hillsboro, OR 97124-6497  
Phone: 1-800-628-8686

This equipment has been tested and found to comply with the limits for a Class A digital device, pursuant to Part 15 of the FCC Rules. These limits are designed to provide reasonable protection against harmful interference in a commercial installation. This equipment generates, uses, and can radiate radio frequency energy and, if not installed and used in accordance with the instructions, may cause harmful interference to radio communications. However, there is no guarantee that interference will not occur in a particular installation. If this equipment does cause harmful interference to radio or television reception, which can be determined by turning the equipment off and on, the user is encouraged to try to correct the interference by one or more of the following measures:

- Reorient or relocate the receiving antenna.
- Increase the separation between the equipment and the receiver.
- Connect the equipment into an outlet on a circuit different from that to which the receiver is connected.
- Consult the dealer or an experienced radio/TV technician for help.

Intel is not responsible for any radio or television interference caused by unauthorized modification of this equipment for substitution or attachment of connecting cables and equipment other than those specified by Intel. The correction of interferences caused by such unauthorized modification, substitution, or attachment will be the responsibility of the user.

This RAID Controller has been tested to comply with FCC standards for office use.

- ICES-003 (Canada) This digital apparatus does not exceed the Class A limits for radio noise emissions from digital apparatus set out in the interference-causing equipment standard entitled "Digital Apparatus," ICES-003 of the Canadian Department of Communications.

Cet appareil numérique respecte les limites bruits radioélectriques applicables aux appareils numériques de Classe A prescrites dans la norme sur le matériel brouilleur: "Appareils Numériques", NMB-003 dictée par le Ministre Canadien des Communications.

- Europe (CE Declaration of Conformity) This product has been tested in accordance too, and complies with the Low Voltage Directive (73/23/EEC)

and EMC Directive (89/336/EEC). The product has been marked with the CE Mark to illustrate its compliance.



# Appendix C: Drive Roaming and Drive Migration Install

---

## Drive Roaming

Drive roaming occurs when the hard drives are changed to different ports on the same controller. When the drives are placed on different ports, the controller detects the RAID configuration from the configuration data on the drives.

**Note:** *If you move a drive that is currently being rebuilt, the rebuild operation will restart, not resume.*

To use drive roaming, follow these steps:

1. Turn off the power to the system, all drives, enclosures, and system components. Remove the power cord(s).
2. Remove the server system cover. For instructions, see your server system documentation.
3. Move the drives to different positions on the backplane to change the targets. For instructions to install and remove drives, see your server documentation.
4. Determine the target requirements.
5. Make sure the drives are inserted properly.
6. Install the server system cover. For instructions, see your server system documentation.
7. Plug in and power on the system.

The controller detects the RAID configuration from the configuration data on the drives (COD).

# Drive Migration

Drive migration moves a configured set of hard drives from one controller to another. The drives must remain on the same port and be reinstalled in the same order as in the original configuration. The controller to which you migrate the drives cannot have an existing configuration.

**Note:** *Only complete configurations can be migrated; individual virtual disks cannot be migrated. Drive roaming and drive migration cannot be supported at the same time.*

To migrate drives, follow these steps:

1. Clear the configuration on the system to which you migrate the drives. This prevents a configuration data mismatch between the hard drives and the NVRAM.
2. Turn off the power to the system, all drives, enclosures, and system components. Remove the power cord(s).
3. Remove the server system cover. For instructions, see your server system documentation.
4. Disconnect the cables from the drives to be migrated.
5. Remove the hard drives from the first system and install them into the second system. For instructions to install and remove drives, see your server documentation.
6. Connect the data cables to the hard drives in the second system in the same order as they were connected in the first system. Make sure all the cables meet specifications.
7. Determine the drive target requirements.
8. Make sure all cables are properly attached and the RAID controller is properly installed.
9. Install the server system cover. For instructions, see your server system documentation.
10. Plug in and power on the system.

When you start the system, the controller detects the RAID configuration from the configuration data on the drives.