



Intel[®] Server Boards S3000AHLX, S3000AH, and S3000AHV

Technical Product Specification

Intel Order Number: D72579-003

Revision 1.4

November 2008

Enterprise Platforms and Services Division

Revision History

Date	Revision Number	Modifications
August 2006	1.0	Initial external release.
December 2006	1.1	<ul style="list-style-type: none"> - Removed AHCI from BIOS setup menu. - Added "SPI/FWH Selection Header" section. - Revised memory section. - Updated S3000AH and S3000AHV SKU NIC controller from 82573V to 82573E. - Updated "Clear CMOS and System Maintenance Mode Jumpers" section. - Added Intel® Matrix Storage Technology feature support.
March 2008	1.2	<ul style="list-style-type: none"> - Added 1333FSB processor support notification(page 16) - Added notification for SATA device when enabling RAID option(page 65)
April 2008	1.3	- Added reference documents and correct error
November 2008	1.4	<ul style="list-style-type: none"> - Corrected MCH Memory Sub-System Overview section. - Modified Server Board Mechanical Drawings PCI slot voltage error.

Disclaimers

Information in this document is provided in connection with Intel® products. No license, express or implied, by estoppel or otherwise, to any intellectual property rights is granted by this document. Except as provided in Intel's Terms and Conditions of Sale for such products, Intel assumes no liability whatsoever, and Intel disclaims any express or implied warranty, relating to sale and/or use of Intel products including liability or warranties relating to fitness for a particular purpose, merchantability, or infringement of any patent, copyright or other intellectual property right. Intel products are not intended for use in medical, life saving, or life sustaining applications. Intel may make changes to specifications and product descriptions at any time, without notice.

Designers must not rely on the absence or characteristics of any features or instructions marked "reserved" or "undefined." Intel reserves these for future definition and shall have no responsibility whatsoever for conflicts or incompatibilities arising from future changes to them.

The Intel® Server Boards S3000AHLX, S3000AH, and S3000AHV may contain design defects or errors known as errata that may cause the product to deviate from published specifications. Current characterized errata are available on request.

Intel Corporation server baseboards support peripheral components and contain a number of high-density VLSI and power delivery components that need adequate airflow to cool. Intel's own chassis are designed and tested to meet the intended thermal requirements of these components when the fully integrated system is used together. It is the responsibility of the system integrator that chooses not to use Intel developed server building blocks to consult vendor datasheets and operating parameters to determine the amount of air flow required for their specific application and environmental conditions. Intel Corporation cannot be held responsible if components fail or the server board does not operate correctly when used outside any of their published operating or non-operating limits.

Intel, Pentium®, Itanium, and Xeon are trademarks or registered trademarks of Intel Corporation.

*Other brands and names may be claimed as the property of others.

Copyright © Intel Corporation 2006 - 2008.

Table of Contents

1. Introduction	1
1.1 Chapter Outline.....	1
1.2 Server Board Use Disclaimer	1
2. Server Board Overview.....	2
2.1 Server Board Feature Set.....	2
2.2 Server Board Layout.....	5
2.2.1 Connector and Component Locations	6
2.2.2 Server Board Mechanical Drawings	12
3. Functional Architecture	15
3.1 Processor Sub-System	16
3.1.1 Processor Voltage Regulator Down (VRD).....	16
3.1.2 Reset Configuration Logic	16
3.2 Intel® 3000 Chipset	17
3.2.1 Memory Controller Hub (MCH).....	17
3.2.2 PCI-X* Hub (PXH).....	19
3.2.3 I/O Controller Hub.....	20
3.3 Memory Sub-System	23
3.3.1 Memory Configuration	23
3.3.2 Memory DIMM Support.....	26
3.4 I/O Sub-System	26
3.4.1 PCI Subsystem	26
3.4.2 Interrupt Routing	28
3.5 On-Board Components.....	33
3.5.1 Video Support.....	33
3.5.2 Network Interface Controller (NIC)	34
3.5.3 Super I/O Chip.....	35
3.5.4 BIOS Flash	36
3.5.5 System Health Support.....	36
3.6 Replacing the Back-Up Battery.....	37
4. System BIOS.....	38
4.1 BIOS Identification String.....	38
4.2 Logo or Diagnostic Window	39

4.3	BIOS Setup Utility	39
4.3.1	Operation	39
4.3.2	Server Platform Setup Screens	42
4.4	Loading BIOS Defaults	63
4.5	Multiple Boot Blocks	63
4.6	Recovery Mode.....	63
4.7	Intel® Matrix Storage Manager.....	64
4.8	Intel® Embedded Server RAID Technology	64
5.	Error Reporting and Handling	65
5.1	Error Handling and Logging.....	65
5.1.1	Error Sources and Types.....	65
5.1.2	Error Logging via SMI Handler	66
5.1.3	SMBIOS Type 15.....	66
5.1.4	Logging Format Conventions.....	66
5.2	Error Messages and Error Codes	68
5.2.1	Diagnostic LEDs	68
5.2.2	POST Code Checkpoints.....	69
5.2.3	POST Error Messages and Handling	72
5.2.4	POST Error Beep Codes	73
5.2.5	POST Error Pause Option	73
6.	Connectors and Jumper Blocks	74
6.1	Power Connectors	74
6.1.1	Main Power Connector	74
6.2	Intel® Adaptive Slot	75
6.3	SMBus Connector.....	79
6.4	IDE Connector	79
6.5	Front Panel Connector.....	80
6.6	I/O Connectors.....	80
6.6.1	VGA Connector.....	80
6.6.2	NIC Connectors	80
6.6.3	SATA Connectors	82
6.6.4	Floppy Controller Connector.....	82
6.6.5	Serial Port Connectors.....	83
6.6.6	Keyboard and Mouse Connector	83
6.6.7	USB Connector.....	84

6.7	Fan Headers	84
6.8	Miscellaneous Headers and Connectors	85
6.8.1	Back Panel I/O Connectors	85
6.8.2	Chassis Intrusion Header	86
6.8.3	HDD ACTIVE LED Header	86
6.9	Jumper Blocks	87
6.9.1	NIC1 NVM Protect	87
6.9.2	Clear CMOS and System Maintenance Mode Jumpers	87
6.9.3	SPI/FWH Selection Header	88
7.	Absolute Maximum Ratings	89
7.1	Mean Time Between Failures (MTBF) Test Results	89
7.2	Calculated MTBF	89
8.	Design and Environmental Specifications.....	90
8.1	Power Budget	90
8.2	Power Supply Specifications	91
8.2.1	Power Timing Requirements	91
8.2.2	Dynamic Loading	94
8.2.3	AC Line Transient Specification.....	94
8.2.4	AC Line Fast Transient (EFT) Specification	95
8.3	Product Regulatory Compliance	95
8.3.1	Product Safety Compliance	95
8.3.2	Product EMC Compliance – Class A Compliance	96
8.3.3	Certifications / Registrations / Declarations	96
8.3.4	RoHS	96
8.3.5	Product Regulatory Compliance Markings	97
8.4	Electromagnetic Compatibility Notices	98
8.4.1	FCC (USA).....	98
8.4.2	ICES-003 (Canada)	99
8.4.3	Europe (CE Declaration of Conformity)	99
8.4.4	VCCI (Japan).....	99
8.4.5	Taiwan Declaration of Conformity (BSMI).....	99
8.4.6	Korean Compliance (RRL).....	100
8.4.7	CNCA (CCC-China).....	100
8.5	Mechanical Specifications	101
9.	Hardware Monitoring	104

9.1 Monitored Components 104

 9.1.1 Fan Speed Control..... 105

9.2 Chassis Intrusion 105

Glossary..... 106

Reference Documents 109

List of Figures

Figure 1. Intel® Server Board S3000AH.....	5
Figure 2. Intel® Server Board S3000AHLX Layout.....	6
Figure 3. Intel® Server Board S3000AHLX Diagram.....	8
Figure 4. Intel® Server Board S3000AHV SKU Diagram	10
Figure 5. Intel® Server Board S3000AHLX – Hole and Component Positions (1 of 2)	12
Figure 6. Intel® Server Board S3000AHLX – Hole and Component Positions (2 of 2)	13
Figure 7. Intel® Server Board S3000AHLX – Restricted Areas.....	14
Figure 8. Server Board Block Diagram	15
Figure 9. Memory Bank Label Definition	25
Figure 10. Interrupt Routing Diagram	30
Figure 11. Intel® ICH7R Interrupt Routing Diagram	31
Figure 12. PXH-V Interrupt Routing Diagram	32
Figure 13. Setup Utility — Main Screen Display	42
Figure 14. Setup Utility — Advanced Screen Display	44
Figure 15. Setup Utility — Processor Configuration Screen Display	45
Figure 16. Setup Utility — Memory Configuration Screen Display.....	46
Figure 17. Setup Utility — IDE Controller Configuration Screen Display.....	47
Figure 18. Setup Utility — Serial Port Configuration Screen Display.....	49
Figure 19. Setup Utility — USB Configuration Screen Display	50
Figure 20. Setup Utility — PCI Configuration Screen Display	51
Figure 21. Setup Utility — Boot Configuration Screen Display	53
Figure 22. Setup Utility — Hardware Monitor Screen Display	53
Figure 23 Setup Utility — Hardware Monitor Screen Display	54
Figure 24 Setup Utility — Hardware Monitor Screen Display	54
Figure 25. Setup Utility — Security Configuration Screen Display	55
Figure 26. Setup Utility — Server Management Configuration Screen Display	56
Figure 27. Setup Utility — View Event Log	57
Figure 28. Setup Utility — Console Redirection Screen Display	58
Figure 29. Setup Utility — Server Management System Information Screen Display	59
Figure 30. Setup Utility — Boot Options Display	60
Figure 31. Setup Utility — Boot Manager Display.....	61
Figure 32. Setup Utility — Error Manager Screen Display.....	61

Figure 33. Setup Utility — Exit Screen Display 62

Figure 34. Intel® Server Board S3000AHLX Back Panel I/O connectors 85

Figure 35. Intel® Server Board S3000AH Back Panel I/O connectors 85

Figure 36. Intel® Server Board S3000AHV Back Panel I/O connectors 86

Figure 37. Output Voltage Timing 92

Figure 38. Turn On/Off Timing (Power Supply Signals)..... 93

Figure 39. Intel® Server Board S3000AH Mechanical Drawing 101

Figure 40. Pedestal Mount I/O Shield Mechanical Drawing for Intel® Server Board S3000AHV
Figure 41. Pedestal Mount I/O Shield Mechanical Drawing for Intel® Server Boards S3000AH
and S3000AHLX..... 102

Figure 42. Fan Speed Control Block Diagram 105

List of Tables

Table 1. Intel® Server Board S3000AHLX Layout Reference	7
Table 2. Intel® Server Board S3000AHLX Layout Reference	9
Table 3. Processor Support Matrix	17
Table 4. Segment F Connections	18
Table 5. Supported DDR2 Modules	19
Table 6. Segment E Configuration IDs	20
Table 7. Segment D Arbitration Connections.....	20
Table 8. Memory Bank Labels and DIMM Population Order.....	24
Table 9. Characteristics of Dual/Single Channel Configuration with or without Dynamic Mode .	25
Table 10. PCI Bus Segment Characteristics.....	26
Table 11. Segment A Configuration IDs	27
Table 12. Segment A Arbitration Connections.....	27
Table 13. PCI AND PCI-X* Interrupt Routing/Sharing	28
Table 14. Interrupt Definitions.....	29
Table 15. Video Modes	33
Table 16. Intel® 82573E (NIC 1).....	35
Table 17. Intel® 82541PI Gigabit Ethernet Controller (NIC 2).....	35
Table 18. Serial A Header Pin-out	36
Table 19. BIOS Setup Page Layout.....	40
Table 20. BIOS Setup: Keyboard Command Bar.....	41
Table 21. Setup Utility — Main Screen Fields	42
Table 22. Setup Utility — Processor Configuration Screen Fields.....	45
Table 23. Setup Utility — Memory Configuration Screen Fields.....	46
Table 24. Setup Utility — ATA Controller Configuration Screen Fields	48
Table 25. Setup Utility — Serial Ports Configuration Screen Fields	49
Table 26. Setup Utility — USB Configuration Screen Fields	50
Table 27. Setup Utility — PCI Configuration Screen Fields.....	51
Table 28. Setup Utility — Power Screen Fields.....	52
Table 29. Setup Utility — Boot Configuration Screen Fields	53
Table 30. Setup Utility — Security Configuration Screen Fields.....	55
Table 31. Setup Utility — Server Management Configuration Screen Fields	56
Table 32. Setup Utility — Console Redirection Configuration Fields.....	58

Table 33. Setup Utility — Server Management System Information Fields	59
Table 34. Setup Utility — Boot Options Display.....	60
Table 35. Setup Utility — Error Manager Screen Fields	61
Table 36. Setup Utility — Error Manager Screen Fields	61
Table 37. Setup Utility — Exit Screen Fields	62
Table 38. Event List	65
Table 39. SMBIOS Type 15 Event Log record format.....	67
Table 40. Event Type Definition Table.....	67
Table 41. POST Progress Code LED Example	69
Table 42. POST Code Checkpoints.....	69
Table 43. POST Error Messages and Handling.....	73
Table 44. POST Error Beep Codes	73
Table 45. Power Connector Pin-out (J4G1).....	74
Table 46. Auxiliary CPU Power Connector Pin-out (J9B2)	74
Table 47. Intel® Adaptive Slot Pin-out (J4B2)	75
Table 48. SMBus Connector Pin-out (J1E1).....	79
Table 49. ATA 40-pin Connector Pin-out (J3J2)	79
Table 50. Front Panel 24-Pin Header Pin-out (J1J3).....	80
Table 51. VGA Connector Pin-out (J8A1).....	80
Table 52. NIC2-Intel® 82541PI (10/100/1000) Connector Pin-out (JA6A1)	81
Table 53. NIC1- Intel® 82573E (10/100/1000) Connector Pin-out (JA5A1)	81
Table 54. SATA Connector Pin-out (J1G2, J1H1, J1J2, J2J1).....	82
Table 55. Legacy 34-pin Floppy Connector Pin-out (J2J3).....	82
Table 56. External DB-9 Serial A Port Pin-out (J8A1)	83
Table 57. Keyboard and Mouse PS/2 Connectors Pin-out (J9A1).....	83
Table 58. USB Connectors Pin-out (JA5A1).....	84
Table 59. Optional USB Connection Header Pin-out (J1F2)	84
Table 60. Four-pin Fan Headers Pin-out (J7J1, J8D1, J4J1, and J6B1, J6J1).....	84
Table 61. Chassis Intrusion Header (J6J2) Pin-out	86
Table 62. HDD LED Header (J1H2) Pin-out	86
Table 63. NIC1 NVM Protect Mode (J4A1).....	87
Table 64. System Maintenance Mode (J1H3).....	87
Table 65. Clear CMOS Jumper Options (J1G3)	88
Table 66. SPI/FWH Selection Header (J1F1).....	88
Table 67. Absolute Maximum Ratings	89

Table 68. MTBF Data..... 89

Table 69. Power Budget 90

Table 70. Server Board Power Supply Voltage Specification 91

Table 71. Output Voltage Timing 91

Table 72. Turn On/Off Timing 93

Table 73. Transient Load Requirements..... 94

Table 74. AC Line Sag Transient Performance 94

Table 75. AC Line Surge Transient Performance 95

Table 76. Product Certification Markings 97

Table 77. Monitored Components..... 104

< This page intentionally left blank. >

1. Introduction

This Technical Product Specification (TPS) provides a high-level technical description for the Intel® Server Boards S3000AHLX, S3000AH, and S3000AHV. It details the architecture and feature set for all the functional sub-systems of the server boards.

Note: This document uses the term “server board” throughout which applies to all three boards. When exceptions occur, the specific board is called out by name.

1.1 Chapter Outline

This document includes the following chapters:

- Chapter 1 – Introduction
- Chapter 2 – Server Board Overview
- Chapter 3 – Functional Architecture
- Chapter 4 – System BIOS
- Chapter 5 – Platform Management Architecture
- Chapter 6 – Error Reporting and Handling
- Chapter 7 – Connectors and Jumper Blocks
- Chapter 8 – Absolute Maximum Ratings
- Chapter 9 – Design and Environmental Specifications
- Chapter 10 – Hardware Monitoring
- Appendix A – Integration and Usage Tips
- Glossary
- Reference Documents

1.2 Server Board Use Disclaimer

Intel® server boards support add-in peripherals and contain a number of high-density VLSI and power delivery components that need adequate airflow to cool. Intel ensures through its own chassis development and testing that when Intel server building blocks are used together, the fully integrated system will meet the intended thermal requirements of these components. It is the responsibility of the system integrator who chooses not to use Intel developed server building blocks to consult vendor datasheets and operating parameters to determine the amount of airflow required for their specific application and environmental conditions. Intel Corporation cannot be held responsible if components fail or the server board does not operate correctly when used outside any of their published operating or non-operating limits.

2. Server Board Overview

The Intel® Server Boards S3000AHLX, S3000AH, and S3000AHV are monolithic printed circuit boards (PCBs) with features designed to support the entry server market.

2.1 Server Board Feature Set

The server board supports the following feature set:

- Processor and Front Side Bus (FSB) support
 - Supports Dual-Core Intel® Xeon® processor 3000 series, Dual-Core Intel® Xeon® processor 3200 series, Intel® Pentium® processor Extreme Edition (S3000AHLX and S3000AH only), Intel® Pentium® D processors, Intel® Pentium® 4 processors, and Intel® Celeron® D processors in the Intel® LGA775 package
 - Supports Intel® dual-core technology
 - Supports Hyper-Threading Technology
 - Supports Intel® Extended Memory System 64 Technology (Intel® EM64T)
- Intel® 3000 Chipset components
 - Intel® 3000 MCH Memory Controller Hub
 - Intel® ICH7R I/O Controller
 - Intel® 6702 PXH-V PCI-X* Hub (S3000AHLX SKU only)
 - 12-deep In-order Queue
- Memory System
 - Four DIMM sockets supporting DDR2 533/667MHz DIMMs
 - Data bandwidth per channel of 4.2 GB/s or 8.4 GB/s in dual channel when using DDR2 667MHz
 - Support for up to two DDR2 channels for a total of four DIMMs (two DIMMs / Channel) providing up to 8 GB max memory capacity
 - Support for 256 MB, 512 MB, 1 GB, and 2 GB DRAM modules
- I/O Subsystem
 - Intel® Server Board S3000AHLX I/O Subsystem (six independent PCI buses):
 - Segment A: Two PCI 32-bit/33-MHz 3.3V Universal connectors supporting full length PCI add-in cards (*adapters that support 5 V only are not supported*) and one embedded Intel® 10/100/1000 82541PI Gigabit Ethernet Controller (supports *PCI Specification, Rev 2.3*) and one embedded ATI* ES1000 video controller
 - Segment B: One x1 PCI Express* resource implemented as a single x4 PCI Express* connector supporting x1/x2/x4 PCI Express* add-in cards
 - Segment C: One x1 PCI Express* resource implemented as an embedded Intel® 10/100/1000 82573E Gigabit Ethernet Controller
 - Segment D: One x4 PCI Express* resource supporting a PXH-V PCI-X* Hub.
 - Segment E: PXH-V supports one dedicated PCI-X* 66/100MHz slot and the PCI-X portion of the Intel® Adaptive Slot

- Segment F: One x8 PCI Express* resource supporting the PCI Express* portion of the Intel® Adaptive Slot. Supports x1/x2/x4/x8 PCI Express* add-in cards via a riser card
- Intel® Server Board S3000AH I/O Subsystem (Five independent PCI buses):
 - Segment A: Two PCI 32-bit/33-MHz 3.3V Universal connectors supporting full length PCI add-in cards (*adapters which support 5V only are not supported*) and one embedded Intel® 10/100/1000 82541PI Gigabit Ethernet Controller (supports *PCI Specification, Rev 2.3*) and one embedded ATI* ES1000 video controller
 - Segment B: One x1 PCI Express* resource implemented as a single x4 PCI Express connector supporting x1/x2/x4 PCI Express add-in cards
 - Segment C: One x1 PCI Express* resource implemented as an embedded Intel® 10/100/1000 82573E Gigabit Ethernet Controller
 - Segment D: One x4 PCI Express* resource implemented as a single x8 PCI Express connector supporting x1/x2/x4/x8 PCI Express add-in cards
 - Segment F: One x8 PCI Express* resource implemented as a single x8 PCI Express connector supporting x1/x2/x4/x8 PCI Express add-in cards
- Intel® Server Board S3000AHV I/O Subsystem (Four independent PCI Buses):
 - Segment A: Two PCI 32-bit/33-MHz 3.3V Universal connectors supporting full length PCI add-in cards (*adapters which support 5V only are not supported*) and one embedded ATI ES1000 video controller
 - Segment C: One x1 PCI Express* resource implemented as an embedded Intel® 10/100/1000 82573E Gigabit Ethernet Controller
 - Segment D: One x4 PCI Express* resource implemented as a single x8 PCI Express connector supporting x1/x2/x4/x8 PCI Express add-in cards
 - Segment F: One x8 PCI Express* resource implemented as a single x8 PCI Express connector supporting x1/x2/x4/x8 PCI Express add-in cards
- Serial ATA host controller
 - Four independent SATA ports support data transfer rates up to 3.0 Gb/s (300 MB/s) per port
- IDE controller
 - One IDE connector, supporting a maximum of two ATA-100 compatible devices
- Universal Serial Bus 2.0 (USB)
 - Two external USB ports (located at the rear panel) with an additional internal header providing two optional USB ports for front panel support
 - Supports wake-up from sleeping states S1 and S4 (S3 not supported)
 - Supports legacy keyboard and mouse connections when using a PS/2-USB dongle
- LPC (Low Pin Count) bus segment with one embedded device
 - Super I/O controller (SMSC* SCH5027D) providing all PC-compatible I/O (floppy, serial, keyboard, mouse, and two serial com ports) and integrated hardware monitoring
- SSI-compliant connectors for SSI interface support
- Standard 24-pin SSI front panel, 2x12 main power connector, and 2x4 CPU power connector
- Fan Support

- Five general purpose 4-pin fan headers
 - One 4-pin processor fan header (active heat sink required)
 - Four 4-pin system fan headers: SYS FAN1, SYS FAN2, and SYS FAN3 for Intel high density applications to support Intel® Server System SR1530AH; SYS FAN4 is used in the Intel® Entry Server Chassis SC5295-E
- Diagnostic LEDs to display POST code indicators during boot
- On-board SATA RAID
 - Intel® Matrix Storage Technology supports software SATA RAID 0, 1, 5, and 10.
 - Microsoft Windows* driver support only
 - Intel® Embedded Server RAID Technology and the LSI Logic SATA controller support software SATA RAID 0, 1, and 10
 - Driver support available for all supported operating systems

2.2 Server Board Layout

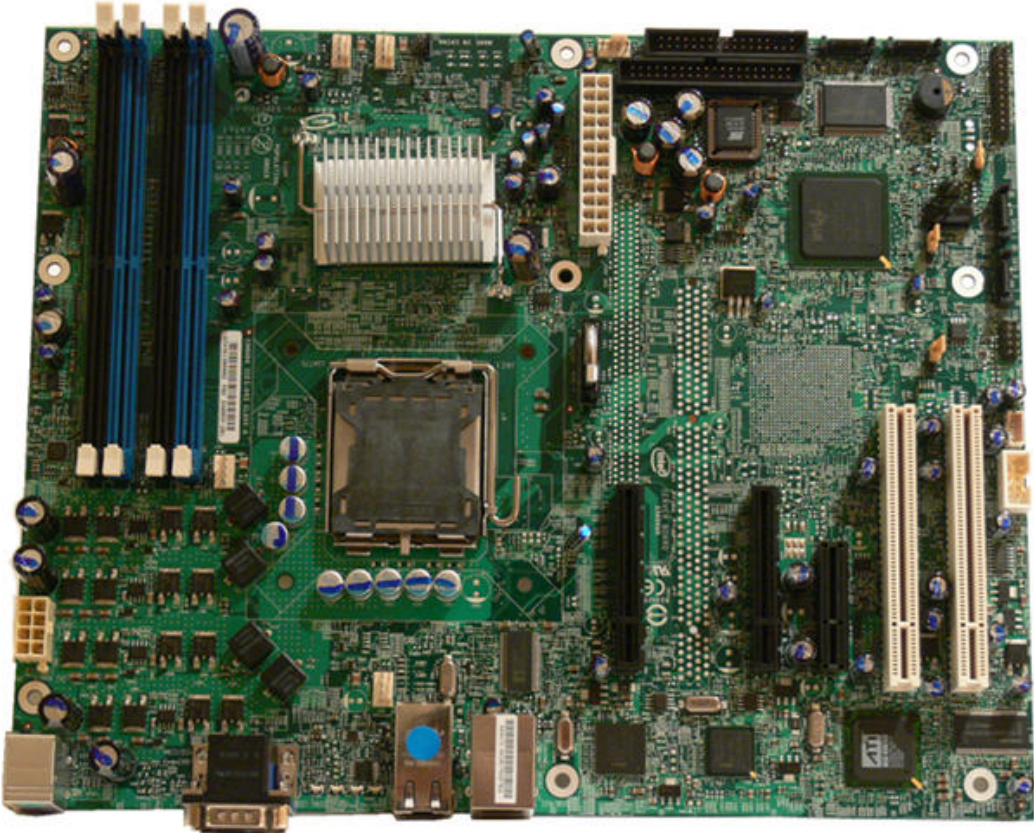

Figure 1. Intel® Server Board S3000AH

2.2.1 Connector and Component Locations

The following figure shows the board layout of the Intel® Server Board S3000AHLX. A letter identifies each connector and major component and the description is included in Table 1.

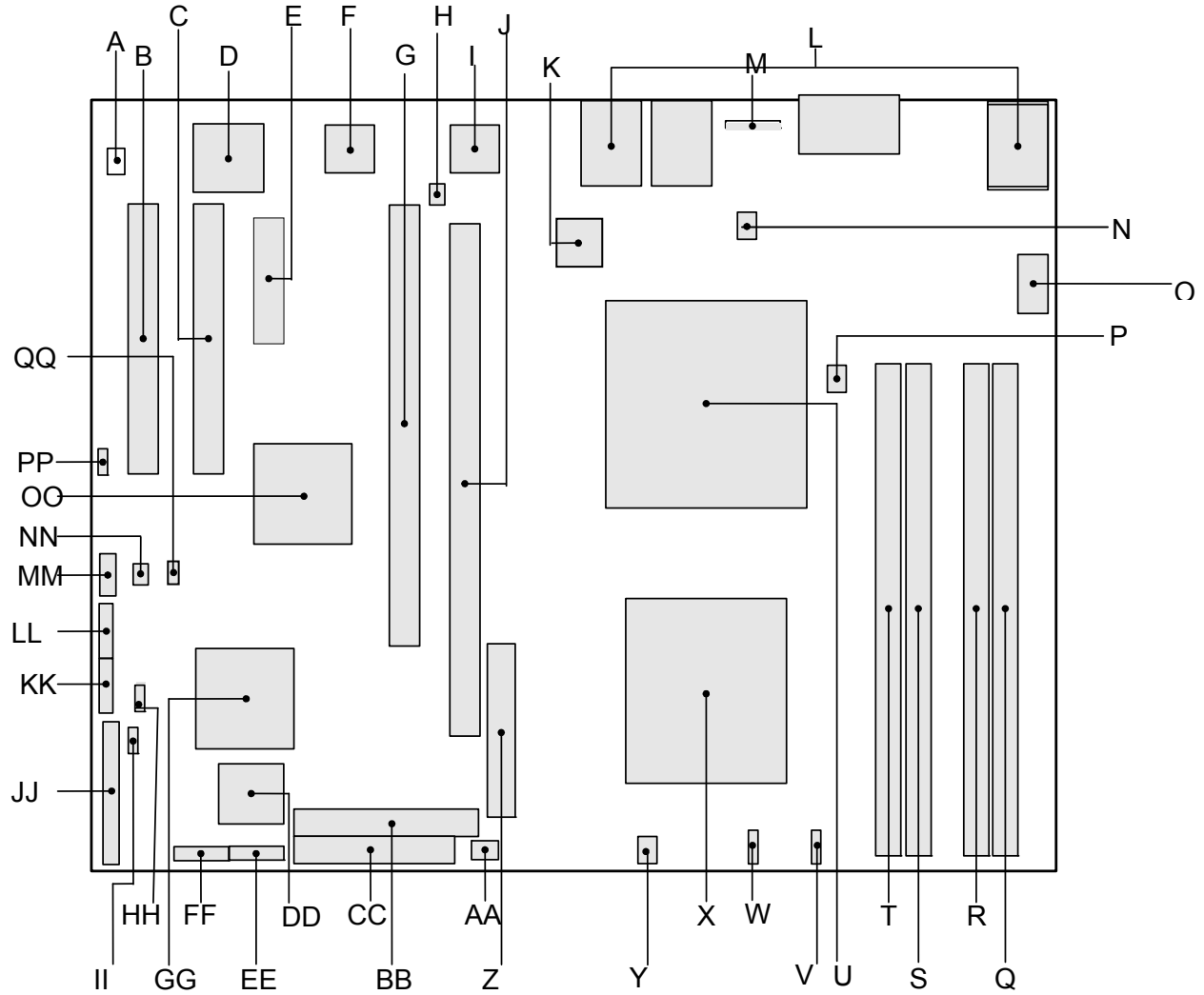

Figure 2. Intel® Server Board S3000AHLX Layout

Table 1. Intel® Server Board S3000AHLX Layout Reference

Ref	Description	Ref	Description	Ref	Description
A	Video Memory	P	CPU FAN	EE	SATA Port 3
B	PCI (32-bit/33 MHz) Slot 1	Q	Memory Slot DIMM 2B	FF	SATA Port 2
C	PCI (32-bit/33 MHz) Slot 2	R	Memory Slot DIMM 1B	GG	Intel® 82801GR (ICH7R)
D	ATI ES1000 Video Controller	S	Memory Slot DIMM 2A	HH	Clear CMOS Jumper
E	PCI Express* x4 (x1 Lane) Slot 3	T	Memory Slot DIMM 1A	II	System Maintenance Mode Jumper
F	Intel® 82541PI NIC Controller	U	775 Land (LGA) CPU Socket	JJ	Front Panel Connector
G	PCI-X* (64-bit/133 MHz) Slot 5	V	SYS FAN2	KK	SATA Port 1
H	NIC SPI Flash	W	SYS FAN1	LL	SATA Port 0
I	Intel® 82573E NIC Controller	X	Intel® 3000 MCH	MM	External USB Connector
J	Intel® Adaptive Slot, Slot 6	Y	Chassis Intrusion Header	NN	BIOS SPI Flash
K	Clock Generator	Z	2 x 12 Main Power Connector	OO	Intel® 6702 PXH-V Controller
L	Back Panel Connectors	AA	SYS FAN3	PP	SMBus Connector
M	Diagnostic POST LEDs	BB	PATA IDE Connector	QQ	SPI/FWH Select Header
N	SYS Fan4	CC	Floppy Connector		
O	2 x 4 CPU Power Connector	DD	SMsC SH5027 SIO		

The following figure shows the board layout of the Intel® Server Board S3000AHLX. A letter identifies each connector and major component and the description is included in Table 2.

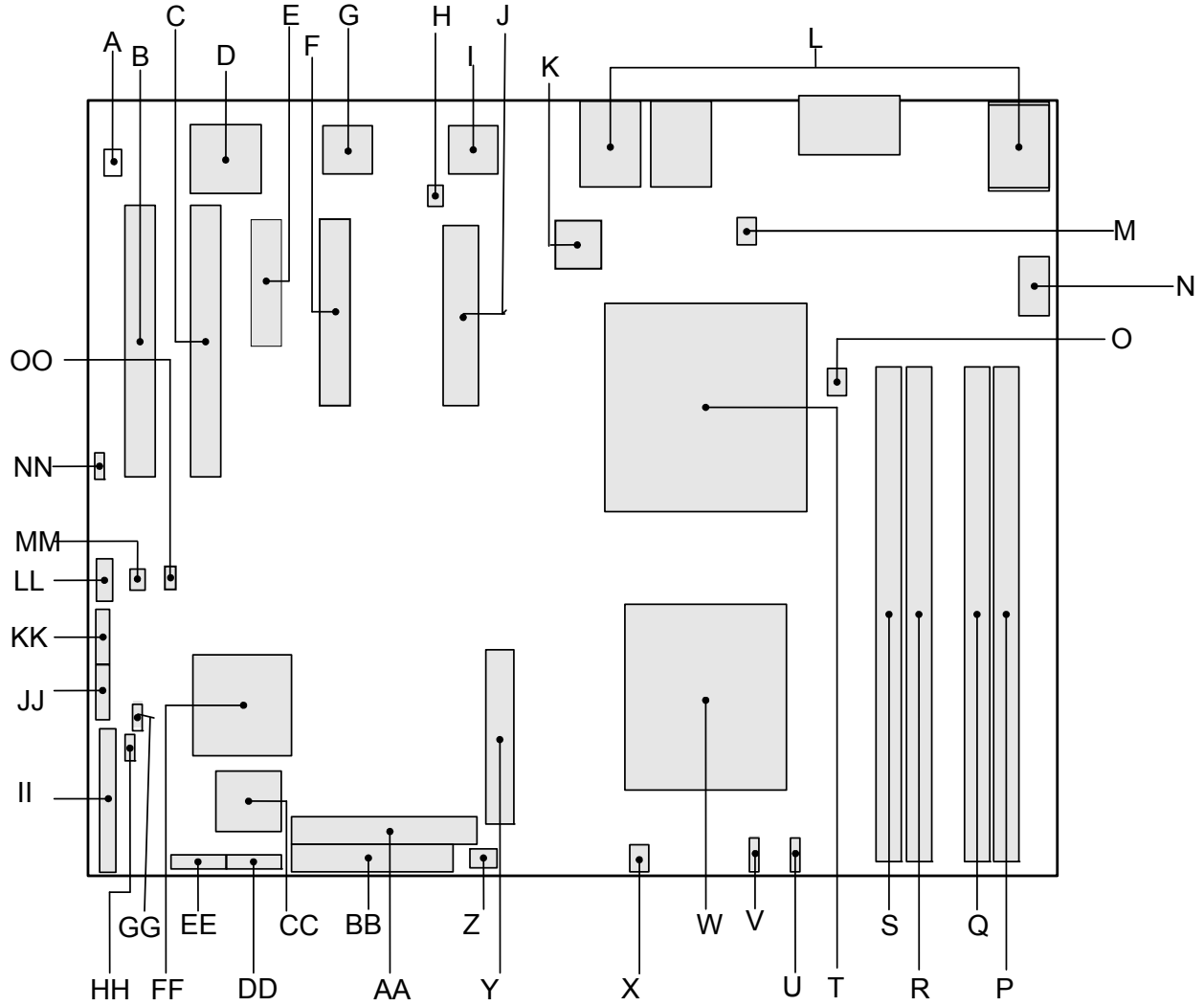

Figure 3. Intel® Server Board S3000AHLX Diagram

Table 2. Intel® Server Board S3000AHLX Layout Reference

Ref	Description	Ref	Description	Ref	Description
A	Video Memory	O	CPU FAN	CC	SMSC* SH5027 SIO
B	PCI (32-bit/33 MHz) Slot 1	P	Memory Slot DIMM 2B	DD	SATA Port 3
C	PCI (32-bit/33 MHz) Slot 2	Q	Memory Slot DIMM 1B	EE	SATA Port 2
D	ATI ES1000 Video Controller	R	Memory Slot DIMM 2A	FF	Intel® 82801GR (ICH7R)
E	PCI Express* x4 (x1 Lane) Slot 3	S	Memory Slot DIMM 1A	GG	Clear CMOS Jumper
F	PCI Express* x8 (x4 lane)	T	775 Land (LGA) CPU Socket	HH	System Maintenance Mode Jumper
G	Intel® 82541PI NIC Controller	U	Intel® 3000 MCH	II	Front Panel Connector
H	NIC SPI Flash	V	SYS FAN2	JJ	SATA Port 1
I	Intel® 82573E NIC Controller	W	SYS FAN1	KK	SATA Port 0
J	PCI Express* x8 (x8 lane)	X	Chassis Intrusion Header	LL	External USB Connector
K	Clock Generator	Y	2 x 12 Main Power Connector	MM	BIOS SPI Flash
L	Back Panel Connectors	Z	SYS FAN3	NN	SMBus Connector
M	SYS FAN4	AA	PATA IDE Connector	OO	SPI/FWH Select Header
N	2 x 4 CPU Power Connector	BB	Floppy Connector		

The following figure shows the board layout of the Intel® Server Board S3000AHV. A letter identifies each connector and major component and the description is included in Table 3.

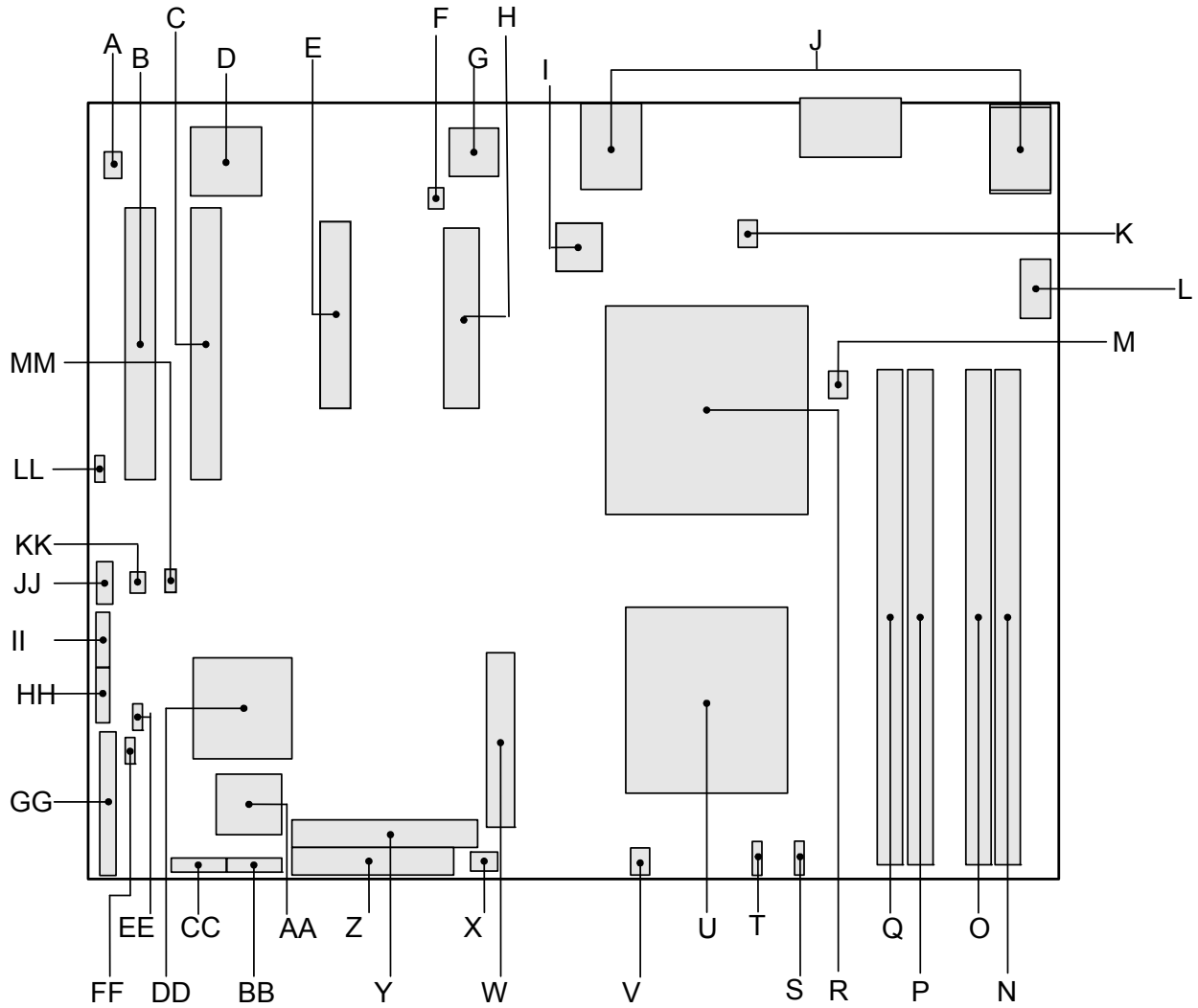

Figure 4. Intel® Server Board S3000AHV SKU Diagram

Table3. Intel® Server Board S3000AHV Layout Reference

Ref	Description	Ref	Description	Ref	Description
A	Video Memory	N	Memory Slot DIMM 2B	AA	SMSC SH5027 SIO
B	PCI (32-bit/33 MHz) Slot 1	O	Memory Slot DIMM 1B	BB	SATA Port 3
C	PCI (32-bit/33 MHz) Slot 2	P	Memory Slot DIMM 2A	CC	SATA Port 2
D	ATI ES1000 Video Controller	Q	Memory Slot DIMM 1A	DD	Intel® 82801GR (ICH7R)
E	PCI Express* x8 (x4 lane)	R	775 Land (LGA) CPU Socket	EE	Clear CMOS Jumper
F	NIC SPI Flash	S	SYS FAN2	FF	System Maintenance Mode Jumper
G	Intel® 82573E NIC Controller	T	SYS FAN1	GG	Front Panel Connector
H	PCI Express* x8 (x8 lane)	U	Intel® 3000 MCH	HH	SATA Port 1
I	Clock Generator	V	Chassis Intrusion Header	II	SATA Port 0
J	Back Panel Connectors	W	2 x 12 Main Power Connector	JJ	External USB Connector
K	SYS FAN4	X	SYS FAN3	KK	BIOS SPI Flash
L	2 x 4 CPU Power Connector	Y	PATA IDE Connector	LL	SMBus Connector
M	CPU FAN	Z	Floppy Connector	MM	SPI/FWH Select Header

2.2.2 Server Board Mechanical Drawings

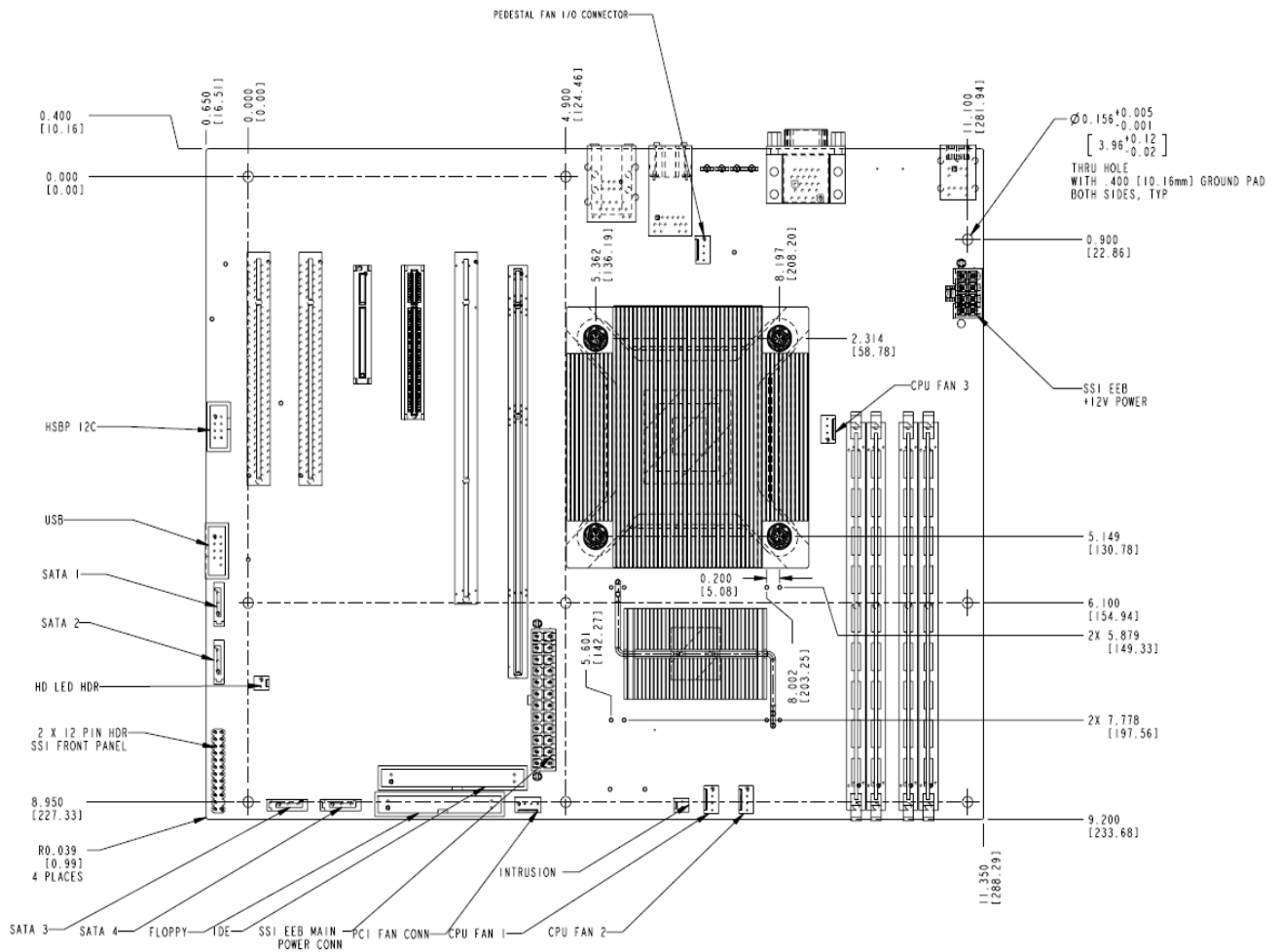

Figure 5. Intel® Server Board S3000AHLX – Hole and Component Positions (1 of 2)

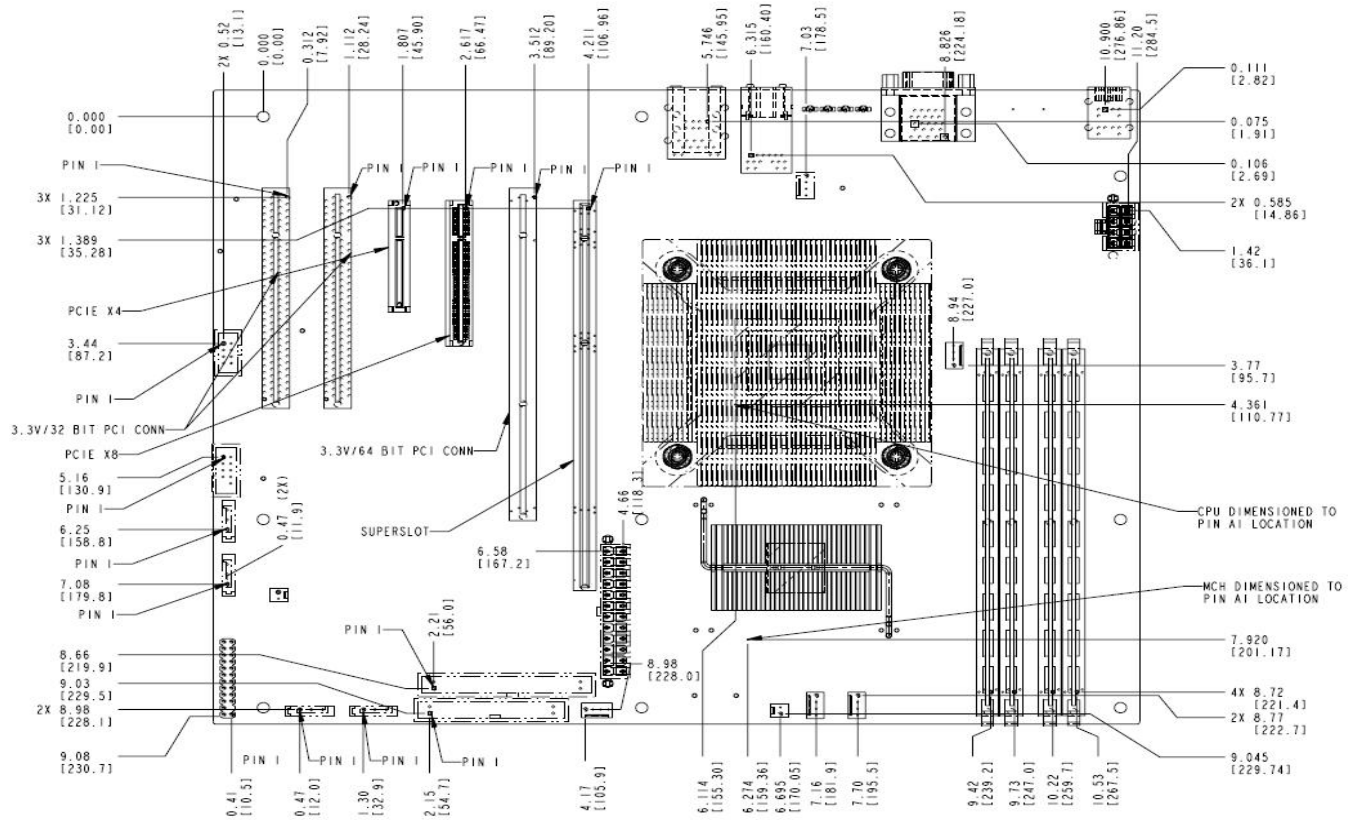

Figure 6. Intel® Server Board S3000AHLX – Hole and Component Positions (2 of 2)

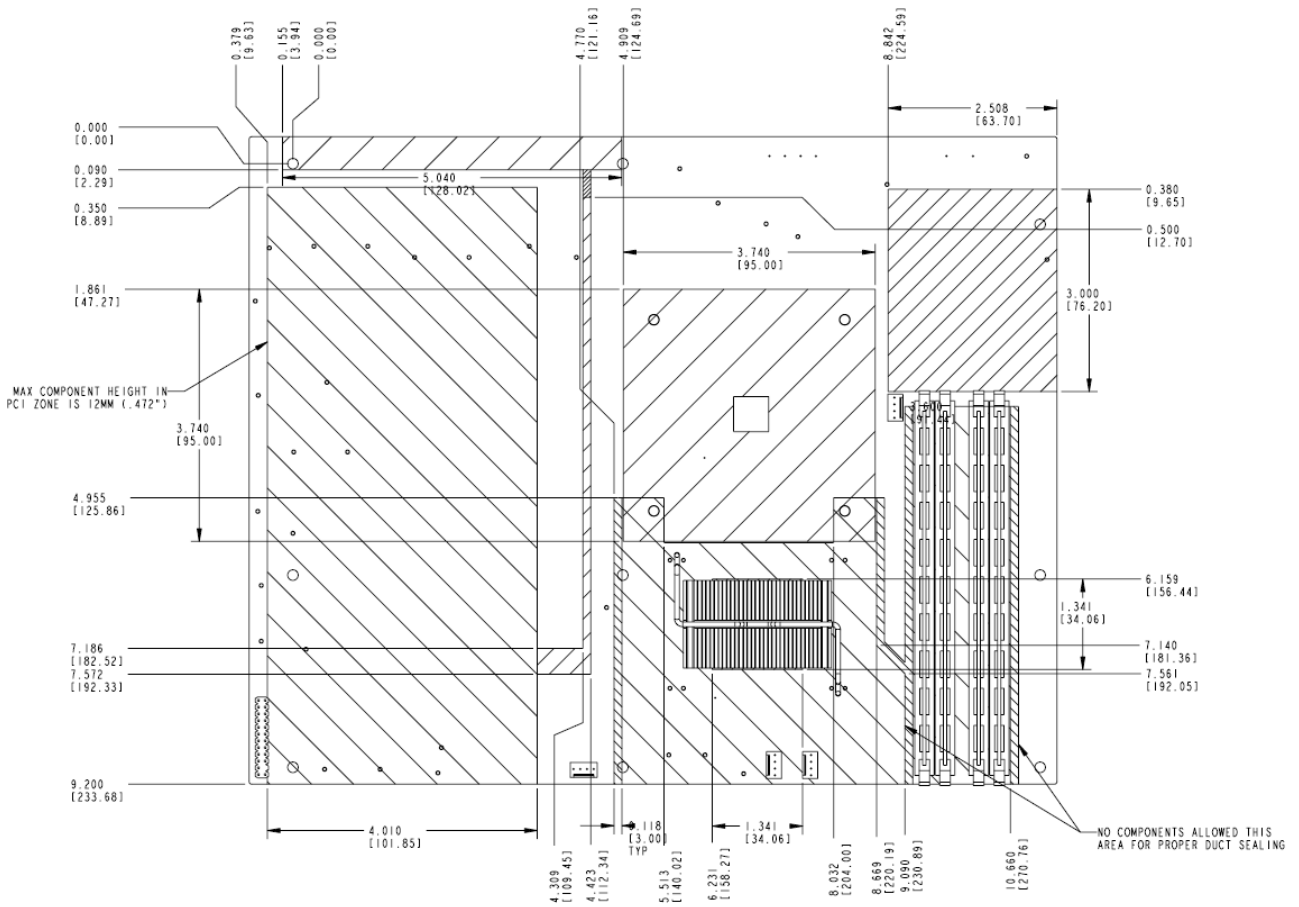

Figure 7. Intel® Server Board S3000AHLX – Restricted Areas

3. Functional Architecture

This chapter provides a high-level description of the functionality associated with the architectural blocks that make up the Intel® Server Boards S3000AHLX, S3000AH, and S3000AHV.

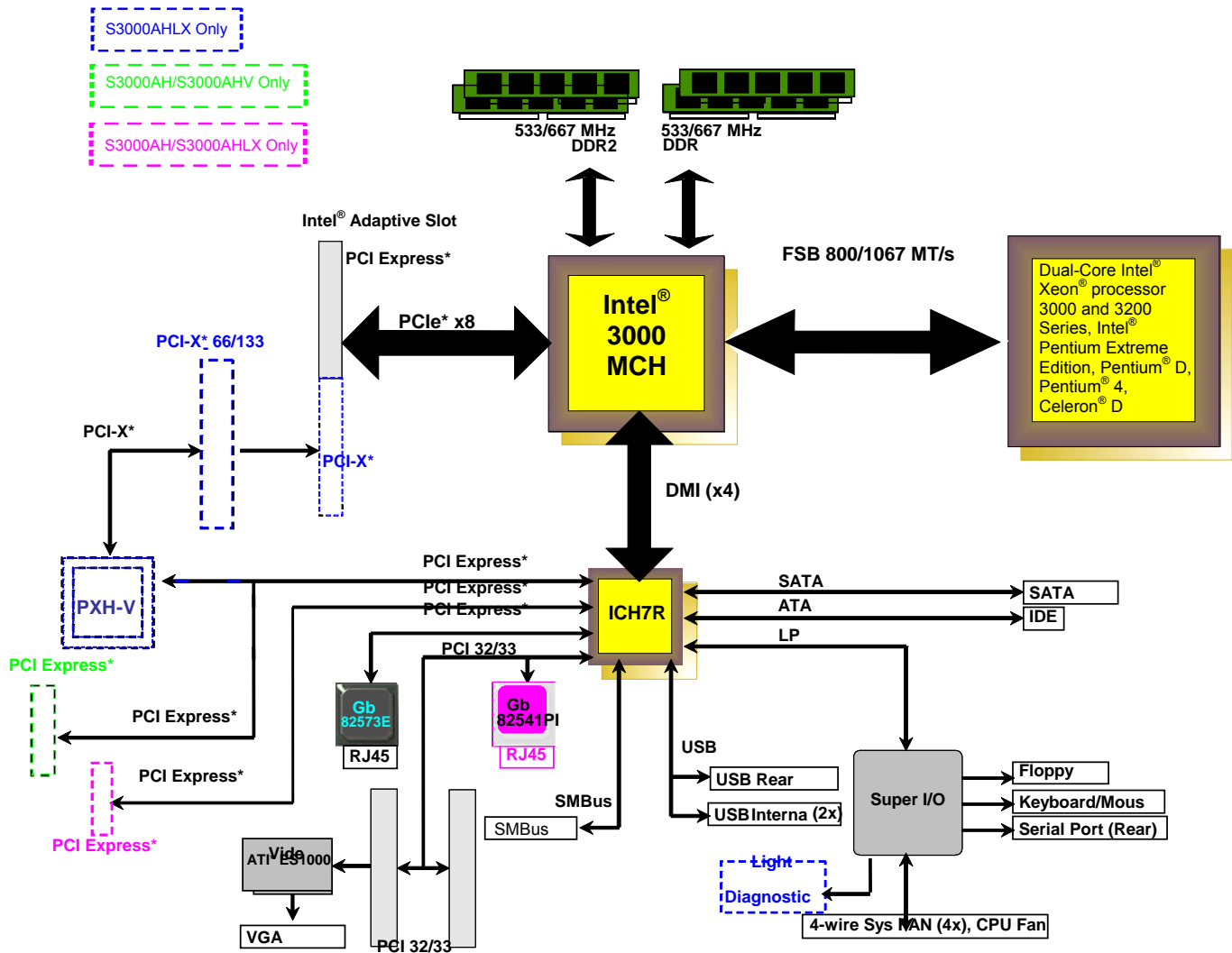

Figure 8. Server Board Block Diagram

3.1 Processor Sub-System

The server board supports the following processors:

- Dual-Core Intel® Xeon® processor 3000 series
Note: The 1333 FSB processor is not supported.
- Dual-Core Intel® Xeon® processor 3200 series
Note: The 1333 FSB processor is not supported.
- Intel® Pentium® processor Extreme Edition (S3000AHLX and S3000AH SKUs only)
- Intel® Pentium® D Processor
- Intel® Pentium® 4 Processor
- Intel® Celeron® D Processor

The processors built on 90nm and 65nm process technology in the 775-land package use Flip-Chip Land Grid Array (FC-LGA4) package technology, and plug into a 775-land LGA socket, referred to as the Intel® LGA775 socket.

The processors in the 775-land package are based on the same Pentium® 4 micro-architecture. They maintain compatibility with 32-bit software written for the IA-32 instruction set, while supporting 64-bit native mode operation when coupled with supported 64-bit operating systems and applications.

Note: The Intel® Celeron® D processor is not available with Intel® dual-core technology, Hyper-Threading Technology, or Intel® EM64T.

3.1.1 Processor Voltage Regulator Down (VRD)

The server board has a VRD (Voltage Regulator Down) to support one processor. It is compliant with the *VRD 11 DC-DC Converter Design Guide Line* and provides a maximum of 125 A.

The board hardware monitors the processor VTEN (Output enable for VTT) pin before turning on the VRD. The Power ON Logic will not turn on the VRD if the VTEN pin of the processors is not asserted.

3.1.2 Reset Configuration Logic

The BIOS determines the processor stepping and processor cache size through the CPUID instruction. The processor information is read at every system power-on.

Note: The processor speed is the processor power-on reset default value. No manual processor speed setting options exist either in the form of a BIOS setup option or jumpers.

Table 3. Processor Support Matrix

Process Name	Socket	Core Frequency	Cache size	FSB Frequency
Dual-Core Intel® Xeon® processor 3000 series	Intel® LGA775	1.86 GHz – 2.66 GHz	2 MB or 4 MB	1006 MHz
Dual-Core Intel® Xeon® processor 3200 series	Intel® LGA775	2.13 GHz – 2.40 GHz	8 MB	1006 MHz
Intel® Pentium® 4 processor Extreme Edition	Intel® LGA775	3.73 GHz	2 MB L2	1066 MHz
Intel® Pentium® D	Intel® LGA775	3.2 – 4.0 GHz	2 x 1 MB L2	800 MHz
Intel® Pentium® 4	Intel® LGA775	3.2 – 4.0 GHz	1 MB or 2 MB L2	800 MHz
Intel® Celeron® D	Intel® LGA775	2.26 – 3.2 GHz	256 K L2	533 MHz

Note: For a complete list of all supported processors, refer to the Intel® Server Board S3000AH support site located at the following URL:

<http://support.intel.com/support/motherboards/server/S3000AH>

3.2 Intel® 3000 Chipset

The Intel® Server Board S3000AH is designed around the Intel® 3000 Chipset. The chipset provides an integrated I/O bridge and memory controller, and a flexible I/O subsystem core (PCI Express*). The following lists the three primary components of the chipset.

3.2.1 Memory Controller Hub (MCH)

3.2.1.1 Intel® 3000 Chipset MCH: Memory Control Hub

The MCH accepts access requests from the host (processor) bus and directs those accesses to memory or to one of the PCI Express* or PCI buses. The MCH monitors the host bus, examining addresses for each request. One of the following queues directs the access request:

- Memory request queue: Provides subsequent forwarding to the memory subsystem.
- Outbound request queue: Provides subsequent forwarding to one of the PCI Express* or PCI buses

The MCH also accepts inbound requests from the Intel® ICH7R. The MCH is responsible for generating the appropriate controls to control data transfer to and from memory.

The MCH is a 1210-ball FC-BGA device and uses the proven components of the following previous generations:

- Hub interface unit
- PCI Express* interface unit
- DDR2 memory interface unit

The MCH incorporates an integrated PCI Express* interface. The PCI Express interface allows the MCH and PCI Express devices to communicate directly. The MCH also increases the main memory interface bandwidth and maximum memory configuration with a 64-bit wide memory interface.

The MCH integrates the following main functions:

- An integrated high performance main memory subsystem
- A PCI Express* bus which provides an interface to the PCI Express* devices (fully compliant to the *PCI Express* Base Specification, Rev 1.0a*)
- A DMI which provides an interface to the Intel® ICH7R

Other features provided by the MCH include the following:

- Full support of ECC on the processor bus
- Twelve deep in-order queue, two deep defer queue
- Full support of un-buffered DDR2 ECC DIMMs
- Support for 512 MB, 1 GB, and 2 GB DDR2 memory modules

3.2.1.2 Segment F PCI Express* x8

The MCH PCI Express* Lanes 0-7 provide a x8 PCI Express connection directly to the MCH. This resource can support x1, x4, x 8 PCI Express add-in cards with PCI-E slot or through the I/O riser when using the Intel® Adaptive Slot.

Table 4. Segment F Connections

Lane	Device
Lane 0-7	Slot 6 or Super Slot (PCI Express* x8)

3.2.1.3 MCH Memory Sub-System Overview

The MCH integrates a system memory DDR2 controller with two 64-bit wide interfaces. Only Double Data Rate 2 (DDR2) memory is supported; consequently, the buffers support only SSTL_1.8 V signal interfaces. The memory controller interface is fully configurable through a set of control registers.

3.2.1.3.1 DDR2 Configurations

The DDR2 interface supports up to 8 GB of main memory and supports single- and double-density DIMMs. The DDR2 can be any industry-standard DDR2. The following table shows the DDR2 DIMM technology supported.

Table 5. Supported DDR2 Modules

DDR2-533/667 Un-buffered SDRAM Module Matrix					
DIMM Capacity	DIMM Organization	SDRAM Density	SDRAM Organization	# SDRAM Devices/rows/Banks	# Address bits rows/Banks/column
512 MB	64 M x 72	256 Mbit	32 M x 8	18 / 2 / 4	13 / 2 / 10
512 MB	64 M x 72	512 Mbit	64 M x 8	9 / 1 / 4	14 / 2 / 10
1 GB	128 M x 72	512 Mbit	64 M x 8	18 / 2 / 4	14 / 2 / 10
1 GB	128 M x 72	1 Gbit	128 M x 8	9 / 1 / 8	14 / 4 / 10
2 GB	256 M x 72	2 GB	128 M x 8	18 / 2 / 8	14 / 8 / 10

3.2.2 PCI-X* Hub (PXH)

PXH-V: PCI-X* Hub (S3000AHLX SKU Only) The PXH-V hub is a peripheral chip that performs PCI/PCI-X* bridging functions between the PCI Express* interface and the PCI/PCI-X bus. The PXH-V contains two PCI bus interfaces that can be independently configured to operate in PCI (33 or 66 MHz), PCI-X Mode1 (66MHz, 100MHz, and 133MHz), for either 32 or 64 bits.

3.2.2.1 Segment E 64-bit/133 MHz PCI-X* Subsystem

One 64-bit PCI-X* bus segment is directed through the PXH-V. This PCI-X segment, segment E, provides the following:

- One 3.3V 64-bit PCI-X slots
- One 3.3V 64-bit PCI-X riser slot (S3000AHLX SKU only)

On Segment E, PCI-X is capable of speeds up to 133 MHz operation and supports full-length PCI and PCI-X adapters. For slot 6, the Intel® Adaptive Slot, the PCI-X bus can run at a maximum 100MHz speed with a PCI-X riser card.

3.2.2.1.1 Device IDs (IDSEL)

Each device under the PCI-X* hub bridge has its IDSEL signal connected to one bit of AD [31:16], which acts as a chip select on the PCI-X bus segment in configuration cycles. This determines a unique PCI-X device ID value for use in configuration cycles. The following table shows the bit attached to each IDSEL signal for P64-C devices and a corresponding device description.

Table 6. Segment E Configuration IDs

IDSEL Value	Device
18	PCI-X* Slot 5 (64-bit/66-133 MHz) (S3000AHLX SKU only)
17	Super Slot 6 (64-bit/66-100 MHz) (riser, S3000AHLX SKU only)

3.2.2.1.2 Segment E Arbitration

PXH-V supports two PCI masters: two PCI-X* slots or one riser slot. All PCI masters must arbitrate for PCI access using resources supplied by the PXH-V. The host bridge PCI interface (PXH-V) arbitration lines REQx* and GNTx* are a special case because they are internal to the host bridge. The following table defines the arbitration connections.

Table 7. Segment D Arbitration Connections

Baseboard Signals	Device
PCIX REQ_N1/GNT_N1	PCI-X* Slot 5 (64-bit/66-133 MHz) (S3000AHLX SKU only)
PCIX REQ_N0/GNT_N0	Super Slot 6 (64-bit/66-100 MHz) (riser, S3000AHLX SKU only)

3.2.3 I/O Controller Hub

3.2.3.1 Intel® ICH7R: I/O Controller Hub 7R

The Intel® ICH7R controller has several components. It provides the interface for a 32-bit/33 MHz PCI bus. The Intel® ICH7R can be both a master and a target on that PCI bus. The Intel® ICH7R includes a USB 2.0 controller and an IDE controller. The Intel® ICH7R is responsible for much of the power management functions with ACPI control registers built in. The Intel® ICH7R also provides a number of General Purpose I/O (GPIO) pins and has the Low Pin Count (LPC) bus to support low speed Legacy I/O.

The MCH and Intel® ICH7R chips provide the pathway between the processor and the I/O systems. The MCH is responsible for accepting access requests from the host (processor) bus, and directing all I/O accesses to one of the PCI buses or Legacy I/O locations. If the cycle is directed to one of the PCI Express* segments, the MCH communicates with the PCI Express Devices (add-in card, on board devices) through the PCI Express interface. If the cycle is directed to the Intel® ICH7R, the cycle is output on the MCH's DMI bus. All I/O for the board, including PCI and PC-compatible I/O, is directed through the MCH and then through the Intel® ICH7R provided PCI buses.

The Intel® ICH7R is a multi-function device, housed in a 609-pin mBGA device. It provides the following:

- A DMI bus
- A PCI 32-bit/33 MHz interface
- An IDE interface
- An integrated Serial ATA Host controller
- A USB controller
- A PCI Express* x4 interface
- Two PCI Express* x1 interfaces
- A power management controller

Each function within the Intel® ICH7R has its own set of configuration registers. Once configured, each appears to the system as a distinct hardware controller sharing the same PCI bus interface.

The primary role of the Intel® ICH7R is providing the gateway to all PC-compatible I/O devices and features. The board uses the following the Intel® ICH7R features:

- PCI 32-bit/33 MHz interface for PCI slots 1 and 2 and Intel® 82541PI Gigabit Ethernet Controllers, and an ATI ES1000 video controller
- LPC bus interface
- x4 PCI Express* interface for PXH-V device (supplies PCI-X* on the LX SKU only)
- x1 PCI Express* resource for dedicated x4 PCI Express* slot
- x1 PCI Express* interface for Intel® 82573E Gigabit Ethernet Controller
- DMI (Direct Media Interface)
- IDE interface, with Ultra ATA 100/66/33 capability
- Integrated quad-port Serial ATA Host controller
- Universal Serial Bus (USB) 2.0 interface
- PC-compatible timer/counter and DMA controllers
- APIC and 82C59 interrupt controller
- Power management
- System RTC
- SMBus 2.0 Specification support
- General purpose I/O (GPIO)

3.2.3.2 PCI Express*

3.2.3.2.1 PCI Express* x4 Subsystem

The Intel® ICH7R supports one PCI Express* x4-lane interface that can also be configured as a single x1 or x4-lane port. The PCI Express interface allows direct connection with the PXH-V or dedicated PCI Express devices (fully compliant to the *PCI Express* Base Specification, Rev 1.0a*).

3.2.3.2.2 PCI Express* x1 Subsystem

The Intel® ICH7R supports two x1 PCI Express* buses. One supports a dedicated x4 PCI Express slot. The other supports the Intel® 82573E Gigabit Ethernet controller.

3.2.3.3 PCI

One 32-bit PCI bus segment is directed through the Intel® ICH7R Interface defined as segment A. This PCI Segment A supports two PCI connectors, one embedded Intel® 82541PI LAN controller, and one ATI ES1000 video controller. For more details on this segment, refer to chapter 3.4.1.

3.2.3.4 IDE Interface (Bus Master Capability and Synchronous DMA Mode)

The Intel® ICH7R acts as a PCI-based Ultra ATA 100/66/33 IDE controller that supports programmed I/O transfers and bus master IDE transfers. The Intel® ICH7R supports one IDE channel, supporting two drives each (drives 0 and 1). The server board provides a 40-pin (2x20) IDE connector to access the IDE functionality.

The IDE interface supports Ultra ATA 100/66/33 Synchronous DMA Mode transfers on the 40-pin connector.

3.2.3.5 SATA Controller

The Intel® ICH7R contains four SATA ports. The data transfer rates up to 300 Mbyte/s per port.

3.2.3.6 Compatibility Modules (DMA Controller, Timer/Counters, Interrupt Controller)

The Intel® ICH7R provides the functionality of two-cascaded 82C59 modules with the capability to handle 15 interrupts. It also supports processor system bus interrupts.

3.2.3.7 Advanced Programmable Interrupt Controller (APIC)

The APICs in the Intel® ICH7R send interrupt generation and notification to the processor using messages on the front side bus.

3.2.3.8 Universal Serial Bus (USB) Controller

The Intel® ICH7R contains one EHCI USB 2.0 controller and can support four USB ports. The USB controller moves data between main memory and up to four USB connectors. All ports function identically and with the same bandwidth.

The server board provides two external USB ports on the rear panel of the server board. The dual-stack USB connector is located within the standard ATX I/O panel area. The *Universal Serial Bus Specification, Revision 1.1*, defines the external connectors.

The third/fourth USB port is optional and can be accessed by cabling from an internal 9-pin connector located on the base board to an external USB port located either in front or the rear of a given chassis.

3.2.3.9 Enhanced Power Management

One of the embedded functions of the Intel® ICH7R is a power management controller that provides ACPI-compliant power management features. The server board supports sleep states S1, S4, and S5.

3.3 Memory Sub-System

The server board supports up to four DIMM slots for a maximum memory capacity of 8 GB. The DIMM organization is x72, which includes eight ECC check bits. The memory interface runs at 533/667 MTs. The memory controller supports the following:

- Single-bit error correction
- Multiple-bit error detection
- Memories using 512 Mbit, 1 Gbit, 2 Gbit DRAM based on memory technology

Memory can be implemented with either single-sided (one row) or double-sided (two row) DIMMs.

3.3.1 Memory Configuration

The memory interface between the MCH and the DIMMs is 72-bit (ECC) wide interface.

There are two banks of DIMMs, labeled 1 and 2. Bank 1 contains DIMM socket locations DIMM_1A and DIMM_2A. Bank 2 contains DIMM socket locations DIMM_1B and DIMM_2B. The sockets associated with each bank or “channel” are located next to each other and the DIMM socket identifiers are marked on the server board silkscreen, near the DIMM socket. Bank 1 is associated with Memory Channel A while Bank 2 is associated with Memory Channel B. When only two DIMM modules are used, the population order must be DIMM_1A, DIMM_1B to ensure dual channel operating mode.

For dual channel dynamic paging mode to function, the following conditions must be met:

- Two identical DIMMs are installed, one each in DIMM_1A and DIMM_1B
- Four identical DIMMs are installed (one in each socket location)

Note: Do not install only three DIMMS on the board. Do not use DIMMs that are not “matched” (same type and speed). Use of identical memory parts is preferred.

See Figure 9 for more information.

The system is designed to populate any rank on either channel, including either degenerate single channel case.

DIMM and memory configurations must adhere to the following requirements:

- DDR2 533/667 MHz, unbuffered, DDR2 DIMM modules
- DIMM organization: x64 non-ECC or x72 ECC
- Pin count: 240
- DIMM capacity: 512 MB, 1 GB and 2 GB DIMMs
- Serial PD: JEDEC Rev 2.0
- Voltage options: 1.8 V
- Interface: SSTL2

Table 8. Memory Bank Labels and DIMM Population Order

Location	DIMM Label	Channel	Population Order
J8J1	(DIMM_1A)	A	1
J8J2	(DIMM_2A)	A	3
J9J1	(DIMM_1B)	B	2
J9J2	(DIMM_2B)	B	4

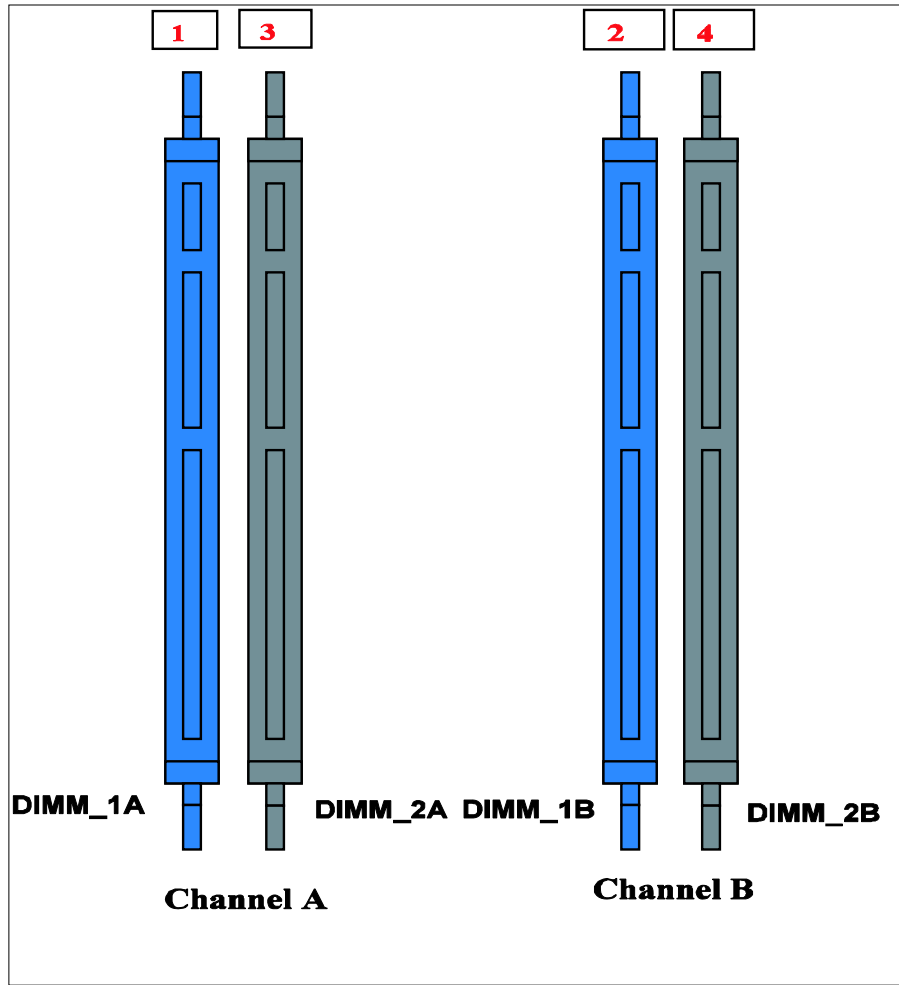

Figure 9. Memory Bank Label Definition

Table 9. Characteristics of Dual/Single Channel Configuration with or without Dynamic Mode

Throughput Level	Configuration	Characteristics
Highest	Dual channel with dynamic paging mode	All DIMMs matched
	Dual channel without dynamic paging mode	DIMMs matched from Channel A to Channel B DIMMs not matched within channels
	Single channel with dynamic paging mode	Single DIMM or DIMMs matched within a channel
Lowest	Single channel without dynamic paging mode	DIMMs not matched

3.3.2 Memory DIMM Support

The board supports unbuffered (not registered) DDR2 533/667 MHz ECC or Non-ECC DIMMs operating at 533/667MT/s. This board only supports DIMMs tested and qualified by Intel or a designated memory test vendor. A list of qualified DIMMs is available at <http://support.intel.com/support/motherboards/server/S3000AH>. Although all DIMMs are supported by design, the board only supports fully qualified DIMMs.

The minimum supported DIMM size is 512 MB. Therefore, the minimum main memory configuration is 1 x 512 MB or 512 MB. The largest size DIMM supported is 2 GB and as such, the maximum main memory configuration is 8 GB implemented by 4 x 2 GB DIMMs.

- Supports unbuffered DDR2 533/667 MHz compliant, ECC x8 and Non-ECC x8 or x16 memory DIMMs.
- Detects and corrects ECC single-bit errors (SBE). Detects multiple-bit errors (MBE).
- The maximum memory capacity is 8 GB via four 2 GB DIMM modules.
- The minimum memory capacity is 512 MB via a single 512 MB DIMM module.

3.4 I/O Sub-System

3.4.1 PCI Subsystem

The primary I/O buses for the server board are five independent PCI bus segments providing PCI, PCI Express* and PCI-X* resources (S3000AHLX SKU only). The PCI buses comply with the *PCI Local Bus Specification, Rev 2.3*.

PCI Segments A, B, C, and D are directed through the Intel® ICH7R. PCI Segment E is independently configured to PXH-V that is through Intel® ICH7R by the PCI Express* x4 interface. The PCI Express X8 interface directs PCI Segment F through the MCH. The following table lists the characteristics of the three PCI bus segments.

Table 10. PCI Bus Segment Characteristics

PCI Bus Segment	Voltage	Width	Speed	Type	PCI I/O Card Slots
A	3.3V	32 bits	33 MHz	PCI 32	Slot 1, Slot 2, NIC 2, video
B	3.3V	1 lane	2.5 GHz	X1 PCI Express*	Slot 3, X4 physical connector
C	3.3V	1 lane	2.5 GHz	X1 PCI Express*	NIC 1
D	3.3V	4 lane	2.5 GHz	X4 PCI Express*	Slot 4, PXH, X8 physical connector
E	3.3V	64 bits	66/100/133 MHz	PCI-64	Slot 5, Slot 6 through riser card
F	3.3V	8 lanes	2.5 GHz	x8 PCI Express*	Slot 6, X8 physical connector

3.4.1.1 P32-A: 32-bit, 33-MHz PCI Subsystem

The Intel® ICH7R provides a Legacy 32-bit PCI subsystem and acts as the central resource on this PCI interface. P32-A supports the following embedded devices and connectors:

- One Intel® 82541PI Fast Ethernet Controller
- One ATI ES1000 Video Controller
- Two slots capable of supporting full-length PCI add-in cards operating at 33 MHz

3.4.1.1.1 Device IDs (IDSEL)

Each device under the PCI hub bridge has its IDSEL signal connected to one bit of AD (31:16), which acts as a chip select on the PCI bus segment in configuration cycles. This determines a unique PCI device ID value for use in configuration cycles. The following table shows the Segment A IDSEL signal and bits and the corresponding device description.

Table 11. Segment A Configuration IDs

IDSEL Value	Device
21	Intel® 82541PI LAN (NIC2)
20	ATI ES1000 Video Controller
17	PCI Slot 1(32-bit/33 MHz)
16	PCI slot 2(32-bit/33 MHz)

3.4.1.1.2 Segment A Arbitration

PCI Segment A supports two PCI devices: the Intel® ICH7R and one PCI bus master (NIC). All PCI masters must arbitrate for PCI access, using resources supplied by the Intel® ICH7R. The host bridge PCI interface (ICH7R) arbitration lines REQx* and GNTx* are a special case in that they are internal to the host bridge. The following table defines the arbitration connections.

Table 12. Segment A Arbitration Connections

Baseboard Signals	Device
PCI REQ_N5/GNT_N5	Intel® 82541PI LAN (NIC2)
PCI REQ_N1/GNT_N1	PCI Slot 1(32-bit/33 MHz)
PCI REQ_N0/GNT_N0	PCI Slot 2(32-bit/33 MHz)

3.4.1.2 PCI Interface for Video subsystem

The Intel® ICH7R uses a 32/33MHz PCI bus to connect to the server board graphics subsystem.

3.4.2 Interrupt Routing

The board interrupt architecture accommodates both PC-compatible PIC mode and APIC mode interrupts through the use of the integrated I/O APICs in the Intel® ICH7R.

3.4.2.1 Legacy Interrupt Routing

For PC-compatible mode, the Intel® ICH7R provides two 82C59-compatible interrupt controllers. The two controllers are cascaded with interrupt levels 8-15 entering on level 2 of the primary interrupt controller (standard PC configuration). The processor receives a single interrupt signal, which the processor responds to for servicing. The Intel® ICH7R contains configuration registers that define which interrupt source logically maps to I/O APIC INTx pins.

The Intel® ICH7R handles both PCI and IRQ interrupts. The Intel® ICH7R translates these to the APIC bus. The numbers in the following table indicate the Intel® ICH7R PCI interrupt input pin to which the associated device interrupt (INTA, INTB, INTC, INTD, INTE, INTF, INTG, INTH for PCI bus and PXIRQ0, PXIRQ1, PXIRQ2, and PXIRQ3 for PCI-X* bus) is connected. The Intel® ICH7R I/O APIC exists on the I/O APIC bus with the processor.

Table 13. PCI AND PCI-X* Interrupt Routing/Sharing

Interrupt	INT A	INT B	INT C	INT D
Intel® 82541PI LAN (NIC2)	PIRQB			
ATI ES1000 Video Controller	PIRQC			
PCI Slot 1 (PCI 32-bit/33 MHz)	PIRQG	PIRQF	PIRQE	PIRQH
PCI Slot 2 (PCI 32-bit/33 MHz)	PIRQF	PIRQG	PIRQH	PIRQE
PCI-X* Slot 5 (64-bit/133 MHz) (LX SKU only)	PXIRQ5	PXIRQ6	PXIRQ7	PXIRQ4
PCI-X* Slot 6 (64-bit/133 MHz) (Riser, LX SKU only)	PXIRQ0	PXIRQ1	PXIRQ2	PXIRQ3

3.4.2.2 APIC Interrupt Routing

For APIC mode, the server board interrupt architecture incorporates three Intel® I/O APIC devices to manage and broadcast interrupts to local APICs in each processor. The Intel® I/O APICs monitor each interrupt on each PCI device including PCI slots in addition to the ISA compatibility interrupts IRQ (0-15).

When an interrupt occurs, a three-wire serial interface sends a message corresponding to the interrupt to the local APICs. The APIC bus minimizes interrupt latency time for compatibility interrupt sources. The I/O APICs can also supply greater than 16 interrupt levels to the processor(s). This APIC bus consists of an APIC clock and two bi-directional data lines.

3.4.2.3 Legacy Interrupt Sources

The following table recommends the logical interrupt mapping of interrupt sources on the board. The actual interrupt map is defined using configuration registers in the Intel® ICH7R.

Table 14. Interrupt Definitions

ISA Interrupt	Description
INTR	Processor interrupt
NMI	NMI to processor
IRQ0	System timer
IRQ1	Keyboard interrupt
IRQ2	Slave PIC
IRQ3	Serial port 1 interrupt from Super I/O device, user configurable
IRQ4	Serial port 1 interrupt from Super I/O device, user configurable
IRQ5	N/A
IRQ6	Floppy disk
IRQ7	Generic
IRQ8_L	Active low RTC interrupt
IRQ9	SCI*
IRQ10	Generic
IRQ11	Generic
IRQ12	Mouse interrupt
IRQ13	Floating processor
IRQ14	Compatibility IDE interrupt from primary channel IDE devices 0 and 1
IRQ15	Secondary IDE cable
SMI*	System Management Interrupt (general purpose indicator sourced by the Intel® ICH7R to the processor)

3.4.2.4 Serialized IRQ Support

The server board supports a serialized interrupt delivery mechanism. Serialized Interrupt Requests (SERIRQ) consists of a start frame, a minimum of 17 IRQ / data channels, and a stop frame. Any slave device in the quiet mode may initiate the start frame. While in the continuous mode, the start frame is initiated by the host controller.

3.4.3 PCI Error Handling

The PCI bus defines two error pins, PERR# and SERR#, for reporting PCI parity errors and system errors, respectively. In the case of PERR#, the PCI bus master has the option to retry the offending transaction or to report it using SERR#. SERR# reports all other PCI-related errors. SERR# is routed to NMI if enabled by BIOS.

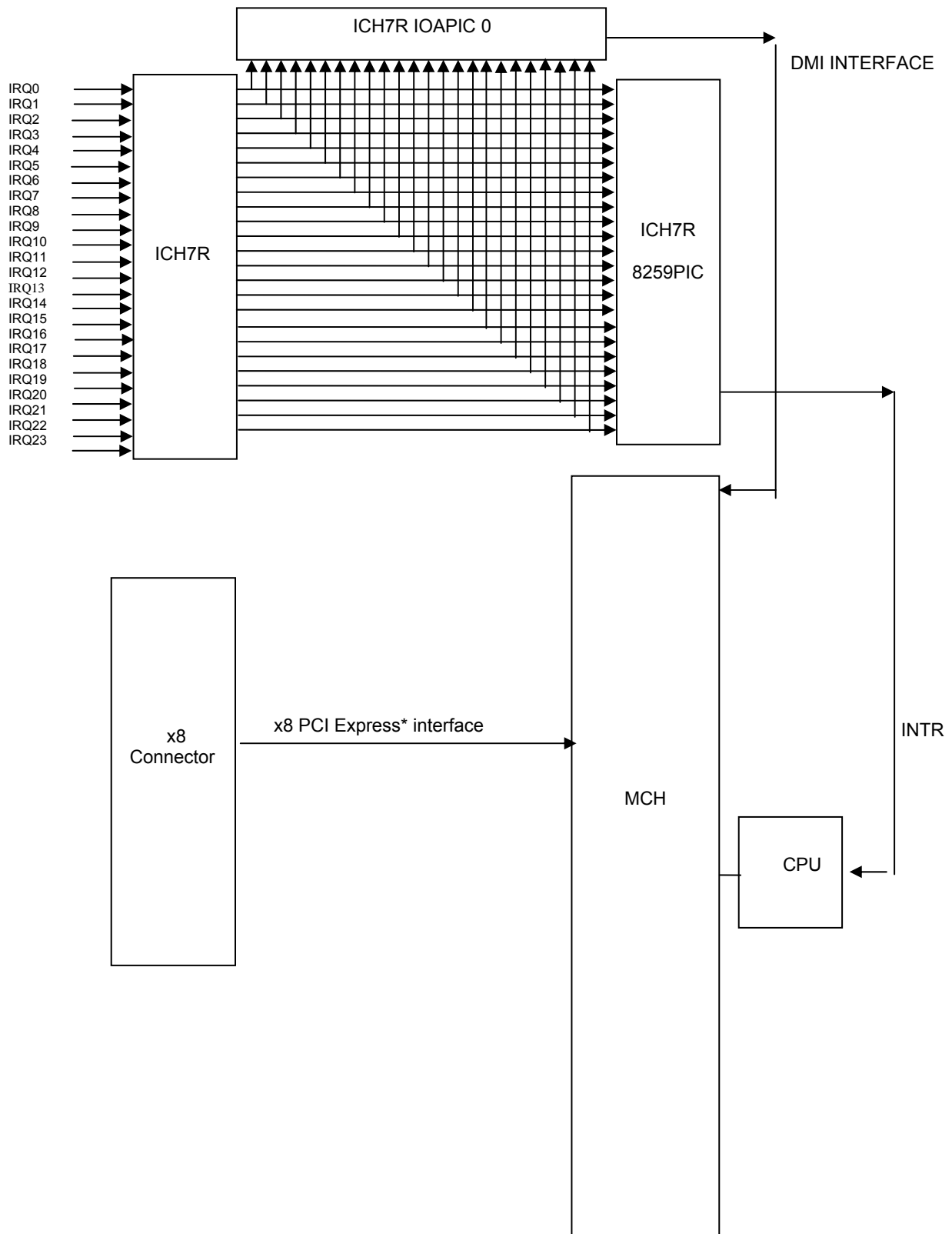

Figure 10. Interrupt Routing Diagram

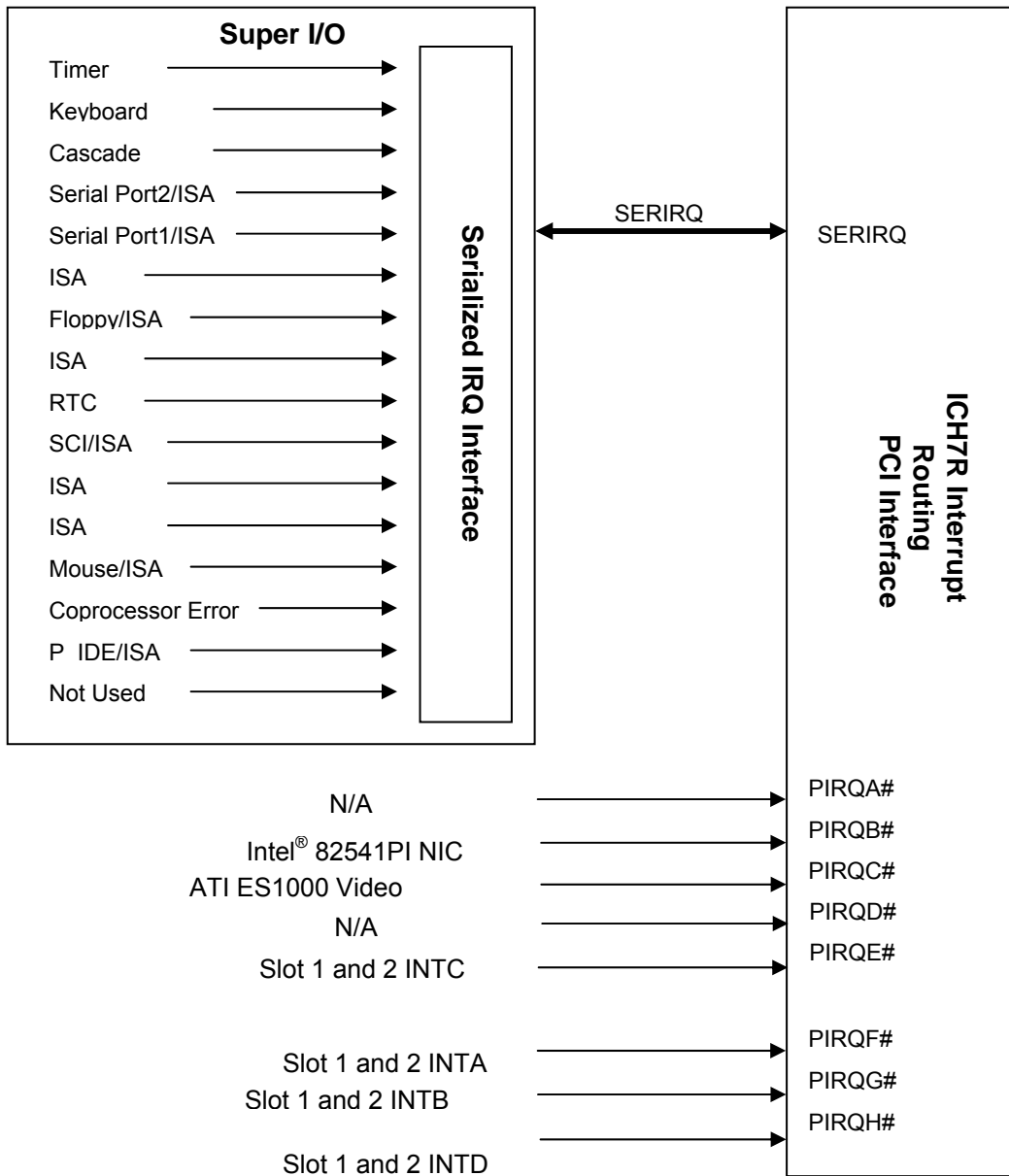

Figure 11. Intel® ICH7R Interrupt Routing Diagram

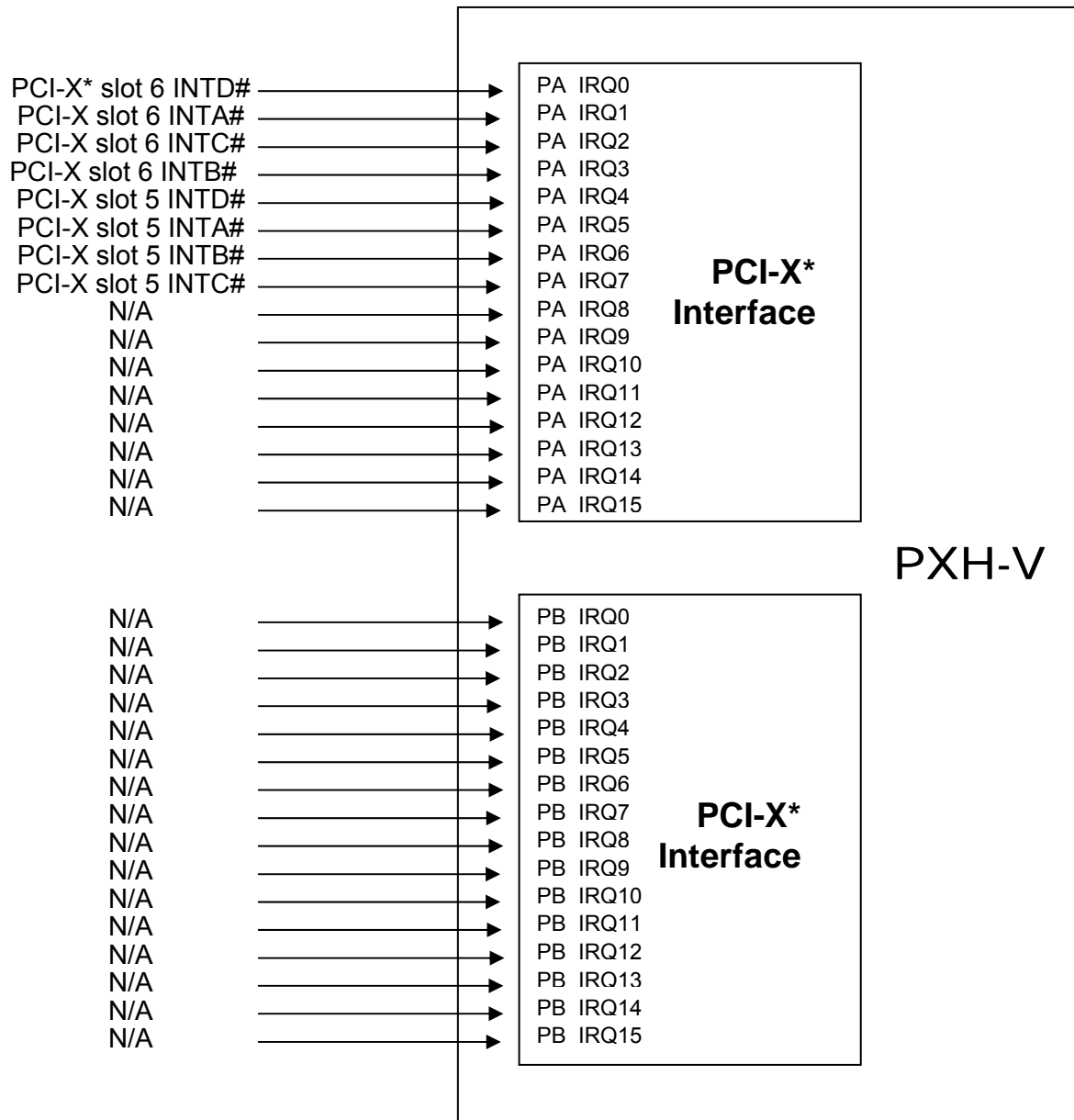

Figure 12. PXH-V Interrupt Routing Diagram

3.5 On-Board Components

3.5.1 Video Support

The server board includes an integrated stand-alone ATI ES1000 graphics engine that supports standard VGA drivers with analog display capabilities. The graphics subsystem has 16 MB of dedicated memory to support the on-board video controller. The baseboard provides a standard 15-pin VGA connector at the rear of the system in the standard ATX I/O opening area. The video controller is disabled by default in BIOS Setup when an off-board video adapter is detected in either the PCI Express* or PCI slots.

3.5.1.1 Video Modes

Table 15. Video Modes

2D Mode	Refresh Rate (Hz)	2D Video Mode Support			
		8 bpp	16 bpp	24 bpp	32 bpp
640x480	60, 72, 75, 90, 100	Supported	Supported	Supported	Supported
800x600	60, 70, 75, 90, 100	Supported	Supported	Supported	Supported
1024x768	60, 72, 75, 90, 100	Supported	Supported	Supported	Supported
1280x1024	43, 60	Supported	Supported	Supported	Supported
1280x1024	70, 72	Supported	–	Supported	Supported
1600x1200	60, 66	Supported	Supported	Supported	Supported
1600x1200	76, 85	Supported	Supported	Supported	–
3D Video Mode Support with Z Buffer Enabled					
3D Mode	Refresh Rate (Hz)	3D Video Mode Support with Z Buffer Enabled			
		8 bpp	16 bpp	24 bpp	32 bpp
640x480	60,72,75,90,100	Supported	Supported	Supported	Supported
800x600	60,70,75,90,100	Supported	Supported	Supported	Supported
1024x768	60,72,75,90,100	Supported	Supported	Supported	Supported
1280x1024	43,60,70,72	Supported	Supported	–	–
1600x1200	60,66,76,85	Supported	–	–	–
3D Video Mode Support with Z Buffer Disabled					
3D Mode	Refresh Rate (Hz)	3D Video Mode Support with Z Buffer Disabled			
		8 bpp	16 bpp	24 bpp	32 bpp
640x480	60,72,75,90,100	Supported	Supported	Supported	Supported
800x600	60,70,75,90,100	Supported	Supported	Supported	Supported
1024x768	60,72,75,90,100	Supported	Supported	Supported	Supported
1280x1024	43,60,70,72	Supported	Supported	Supported	–
1600x1200	60,66,76,85	Supported	Supported	–	–

3.5.1.2 Dual Video

The on-board graphics controller does not support dual video mode. When an add-in video card is populated, the on-board video controller is automatically disabled.

3.5.2 Network Interface Controller (NIC)

The server board supports two 10/100/1000Base-T network interfaces.

- NIC 1 is an Intel® 82573E gigabit Ethernet controller resourced with an x1 PCI Express* interface from the Intel® ICH7R (PCI Segment C).
- NIC2 is an Intel® 82541PI Gigabit Ethernet Controller is resourced with a 32-bit/33 MHz PCI Segment from the Intel® ICH7R (PCI Segment A) on the S3000AHLX and S3000AH SKU only.

Both the Intel® 82573E and Intel® 82541PI Gigabit Ethernet Controllers are single, compact components with an integrated gigabit Ethernet Media Access Control (MAC) and physical layer (PHY) function. The Intel® 82573E and Intel® 82541PI Gigabit Ethernet Controller allow for a gigabit Ethernet implementation in a very small area that is footprint compatible with current generation 10/100 Mbps Fast Ethernet designs. The Intel® 82541PI Gigabit Ethernet Controller and Intel® 82573E integrate the fourth and fifth generation (respectively) gigabit MAC design with fully integrated, physical layer circuitry to provide a standard IEEE 802.3 Ethernet interface for 1000BASE-T, 100BASE_TX, and 10BASE-T applications (802.3, 802.3u, and 802.3ab). The controller is capable of transmitting and receiving data at rates of 1000 Mbps, 100 Mbps, or 10 Mbps. In addition to managing MAC and PHY layer functions, the 82541PI controller provides a 32-bit wide direct Peripheral Component Interconnect (PCI) 2.3 compliant interface capable of operating at 33-or 66-MHz while the 82573E provides a PCI Express* x1 interface.

Both the Intel® 82573E and Intel® 82541PI Gigabit Ethernet Controllers can be disabled and enabled by GPIO pins from the Intel® ICH7R, which is controlled through the BIOS. Both NIC controllers support the Wake ON LAN (WOL) function to wake the system from S1 and S4 sleep states(S3 is not supported).

The Intel® 82573E Gigabit Ethernet controller supports Intel® AMT technology, which is in conflict with teaming implementations. Therefore, the Intel® 82573E Ethernet controller does not support teaming.

3.5.2.1 NIC Connector and Status LEDs

The NICs drive two LEDs located on each network interface connector; the NIC LEDs are compliant with Tables 16 and 17.

Table 16. Intel® 82573E (NIC 1)

LED	Color	LED State	Condition
Left	Green	Off	LAN link is not established
		On	LAN link is established
		Blinking	LAN activity is occurring
Right	N/A	Off	10 Mbit/sec data rate is selected
	Green	On	100 Mbit/sec data rate is selected
	Yellow	On	1000 Mbit/sec data rate is selected

Table 17. Intel® 82541PI Gigabit Ethernet Controller (NIC 2)

LED	Color	LED State	Condition
Left	Green	Off	LAN link is not established
		On	LAN link is established
		Blinking	LAN activity is occurring
Right	N/A	Off	10 Mbit/sec data rate is selected
	Green	On	100 Mbit/sec data rate is selected
	Yellow	On	1000 Mbit/sec data rate is selected

3.5.3 Super I/O Chip

The SMsC SCH5027D Super I/O devices contain all of the necessary circuitry to control the serial ports, parallel ports, floppy disk, PS/2-compatible keyboard, mouse, and hardware monitor controller. The server board implements the following features:

- GPIOs
- One serial port
- Floppy controller
- Keyboard and mouse
- Local hardware monitoring
- Wake up control
- System health support

3.5.3.1 Serial Ports

The server board provides a single serial port implemented as a stand-alone external 9-pin serial port. The following sections provide details on the use of the serial port.

3.5.3.1.1 Serial Port A

Serial Port A is a standard DB9 interface located at the rear I/O panel of the server board—below the video connector. Serial A is designated by “Serial A” on the server board silkscreen. The reference designator is J8A1.

Table 18. Serial A Header Pin-out

Pin	Signal Name	Serial Port A Header Pin-out
1	DCD	
2	DSR	
3	RX	
4	RTS	
5	TX	
6	CTS	
7	DTR	
8	RI	
9	GND	

3.5.3.2 Floppy Disk Support

The floppy disk controller (FDC) in the super I/O is functionally compatible with floppy disk controllers in the DP8473 and N844077. The super I/O integrates all FDC functions including analog data separator and 16-byte FIFO. The server board provides a standard 34-pin interface for the floppy disk controller.

3.5.3.3 Keyboard and Mouse Support

Two external PS/2 ports at the back of the server board allow access to keyboard or mouse functions.

3.5.3.4 Wake-up Control

The super I/O contains functionality that allows various events to control system power-on and power-off.

3.5.4 BIOS Flash

The server board incorporates an SPI flash memory, which can work with 16 Mbit SPI serial flash devices that provide 1024K x 8 or 512K x 8 of BIOS and non-volatile storage space. The Intel ICH7R connects to the flash device through the SPI bus.

3.5.5 System Health Support

SMBus 2.0 is the interface connected to the system health sensors of the super I/O.

- Three PWM-based fan controls
- Software or local temperature feedback control
- Voltage measurement and monitor
- Chassis intrusion detection

3.6 Replacing the Back-Up Battery

The lithium battery on the server board powers the RTC for up to ten years in the absence of power. When the battery starts to weaken, it loses voltage, and the server settings stored in CMOS RAM in the RTC (for example, the date and time) may be wrong. Contact your customer service representative or dealer for a list of approved devices.



WARNING

There is a danger of explosion if the battery is incorrectly replaced. Replace only with the same or equivalent type recommended by the equipment manufacturer. Discard used batteries according to manufacturer's instructions.



ADVARSEL!

Lithiumbatteri - Eksplosionsfare ved fejlagtig håndtering. Udskiftning må kun ske med batteri af samme fabrikat og type. Levér det brugte batteri tilbage til leverandøren.



ADVARSEL

Lithiumbatteri - Eksplosjonsfare. Ved utskifting benyttes kun batteri som anbefalt av apparatfabrikanten. Brukt batteri returneres apparatleverandøren.



WARNING

Explosionsfara vid felaktigt batteribyte. Använd samma batterityp eller en ekvivalent typ som rekommenderas av apparattillverkaren. Kassera använt batteri enligt fabrikantens instruktion.



VAROITUS

Paristo voi räjähtää, jos se on virheellisesti asennettu. Vaihda paristo ainoastaan laitevalmistajan suosittelemaan tyyppiin. Hävitä käytetty paristo valmistajan ohjeiden mukaisesti.

4. System BIOS

4.1 BIOS Identification String

The BIOS Identification string uniquely identifies the revision of the BIOS used on the server. The string has the following format:

```
BoardFamilyID.OEMID.MajorRev.MinorRev.BuildID.BuildDateTime
```

Where:

- BoardFamilyID = String name for this board family
- OEMID = Three-character OEM ID (several Intel® server boards use “86B”)
- MajorRev = Two decimal digits
- MinorRev = Two decimal digits
- BuildID = Four decimal digits
- BuildDateTime = Build date and time in MMDDYYYYHHMM format:
 - MM = Two-digit month
 - DD = Two-digit day of month
 - YYYY = Four-digit year
 - HH = Two-digit hour using a 24-hour clock
 - MM = Two-digit minute

For example, Intel® Server Board S3000AH BIOS Build 3, generated on Jan 21, 2006 at 11:59 AM displays the following BIOS ID string in the POST diagnostic screen:

```
S3000.86B.01.00.0003.012120061159
```

The BIOS version in the Setup Utility is:

```
S3000.86B.01.00.0003
```

The BIOS ID identifies the BIOS image. It does not designate the board ID S3000AH or the BIOS phase (Alpha, Beta, and so forth). The Board ID is available in the SMBIOS type 2 structure. The phase of the BIOS can be determined from the release notes associated with the image. The Board ID is also available via setup.

Support for INT15H, Function DA8Ch (Get BIOSID) was removed. The BIOS ID is available from the SMBIOS type 0 structure.

4.2 Logo or Diagnostic Window

The Logo or Diagnostic window may take one of two forms. In quiet boot mode, a logo splash screen appears. In verbose mode, a system summary and diagnostic screen is displayed. The default is to display the logo in quiet boot mode. If no logo is present in the flash ROM, or if quiet boot mode is disabled in the system configuration, the summary and diagnostic screen is displayed.

The diagnostic screen consists of the following information:

- BIOS ID
- Total memory detected (total size of all installed DIMMs)
- Processor information (Intel branded string, speed, and number of physical processors identified)
- Types of keyboards detected if plugged in (PS/2 and/or USB)
- Types of mouse devices detected if plugged in (PS/2 and/or USB)

4.3 BIOS Setup Utility

The BIOS Setup utility is a text-based utility that allows the user to configure the system and view current settings and environment information for the platform devices. The Setup utility controls built-in devices in the platform.

The BIOS Setup interface consists of a number of pages or screens. Each page contains information or links to other pages. The first page in Setup displays a list of general categories as links. These links lead to pages containing specific category's configuration.

The following sections describe the look and behavior for platform Setup.

4.3.1 Operation

BIOS Setup is functional via console redirection over various terminal emulation standards. This may limit some functionality for compatibility (for example color usage, some keys or key sequences, or support of pointing devices). The BIOS is only available in English.

4.3.1.1 Setup Page Layout

The setup page layout has different functional areas. Each area displays on the screen and has a specific function. The following table lists and describes each functional area.

Table 19. BIOS Setup Page Layout

Functional Area	Description
Title Bar	The title bar is located at the top of the screen and displays the title of the current form (page). It can also display navigational information.
Setup Item List	The Setup Item List is a set of controllable and informational items. Each item in the list occupies the left and center columns in the middle of the screen. The left column, the "Setup Item", is the subject of the item. The middle column, the "Option", contains an informational value or choices. A Setup Item may also be a hyperlink used to navigate form sets (pages). A Setup Item only occupies the "Setup Item" column when it is a hyperlink.
Item Specific Help Area	The Item Specific Help Area is located on the right side of the screen and contains help text for the highlighted Setup Item. Help information includes the meaning and usage of the item, allowable values, effects of the options, and so forth.
Keyboard Command Bar	The Keyboard Command Bar is located at the bottom right of the screen and continuously displays help for keyboard special keys and navigation keys. The keyboard command bar is context-sensitive—it displays keys relevant to the current page and mode.
Status Bar	The Status Bar occupies the bottom line of the screen. This line displays the BIOS ID.

4.3.1.2 Entering BIOS Setup

Start the BIOS Setup by pressing <F2> when the OEM or Intel logo appears.

When Quiet Boot is disabled, the message "Press <F2> to enter setup" displays on the diagnostics screen.

4.3.1.3 Keyboard Commands

The bottom right portion of the Setup screen provides a list of commands used to navigate through the Setup utility. These commands are available at all times.

Each Setup menu page contains a number of features. Each feature is associated with a value field except those used for informative purposes. This field contains user-selectable parameters. Depending on the security option chosen and loaded by the password, a menu feature's value may or may not be changeable. If a value is non-changeable, the feature's value field is inaccessible. It appears "grayed out."

The Keyboard Command Bar supports the following:

Table 20. BIOS Setup: Keyboard Command Bar

Key	Option	Description
<Enter>	Execute Command	The <Enter> key activates the sub-menus when the selected feature is a sub-menu, or to display a pick list if a selected option has a value field, or to select a sub-field for multi-valued features like time and date. If a pick list is displayed, the <Enter> key will select the currently highlighted item, undo the pick list, and return the focus to the parent menu.
<Esc>	Exit	The <Esc> key provides a mechanism for backing out of any field. This key will undo pressing the Enter key. Using the <Esc> key while editing any field or selecting features of a menu causes the parent menu to reload. Using the <Esc> key in any sub-menu causes the parent menu to reload. Using the <Esc> key in any major menu causes the exit confirmation window to load and the user can choose whether to discard changes. If “No” is selected and the <Enter> key is pressed, or if the <Esc> key is pressed, the user is returned to where he/she was before the <Esc> key was pressed, without affecting any existing settings. If “Yes” is selected and the <Enter> key is pressed, the setup is closed and the main BIOS System Options Menu screen appears.
↑	Select Item	Use the up arrow to select the previous value in a pick list, or the previous option in a menu. Press the <Enter> key to activate the selected item.
↓	Select Item	Use the down arrow to select the next value in a menu list, or a value field’s pick list. Press <Enter> to activate the selected item.
←→	Select Menu	Use the left and right arrow keys to move between the major menu pages. The keys have no effect in a sub-menu or pick list.
<Tab>	Select Field	Use the <Tab> key to move between fields. For example, use <Tab> to move from hours to minutes in the time item in the main menu.
-	Change Value	Use the minus key on the keypad to change the value of the current item to the previous value. This key scrolls through the values in the associated pick list without displaying the full list.
+	Change Value	Use the plus key on the keypad to change the value of the current menu item to the next value. This key scrolls through the values in the associated pick list without displaying the full list. On 106-key Japanese keyboards, the plus key has a different scan code than the plus key on the other keyboard, but it will have the same effect.
<F9>	Setup Defaults	Pressing <F9> causes the following message to appear: <div style="border: 1px solid black; padding: 5px; text-align: center;">Load Optimized defaults? (Y/N)</div> If the <Y> key is pressed, all Setup fields are set to their default values. If the <N> or <Esc> keys are pressed, the user is returned to where they were before <F9> was pressed without affecting any existing field values
<F10>	Save and Exit	Pressing <F10> causes the following message to appear: <div style="border: 1px solid black; padding: 5px; text-align: center;">Save Configuration and Reset? (Y/N)</div> If the <Y> key is pressed, all changes are saved and Setup is exited. If the <N> or <Esc> keys are pressed, the user is returned to where they were before <F10> was pressed without affecting any existing field values.

4.3.1.4 Menu Selection Bar

The Menu Selection Bar is located at the top of the screen. It displays the major menu selections available to the user.

4.3.2 Server Platform Setup Screens

The following sections describe the screens available for the configuration of a server platform. In these sections, tables describe the contents of each screen. These tables use the following guidelines:

- The text and values in the Setup Item, Options, and Help columns display in the BIOS Setup screens.
- Bold text in the Options column of the tables indicates default values. The bold text in this document serves as a reference point. These values do not appear with bold text in the setup screen.
- The Comments column provides additional information if it is available. This information does not display in the BIOS Setup screens.
- Information in the screen shots enclosed in brackets (< >) indicates text that varies, depending on the option(s) installed. For example, the actual date replaces <Current Date>.
- Information enclosed in square brackets ([]) in the tables indicates areas where the user needs to type in text instead of selecting from a provided option.

4.3.2.1 Main Screen

The Main screen is the screen displayed when BIOS Setup starts.

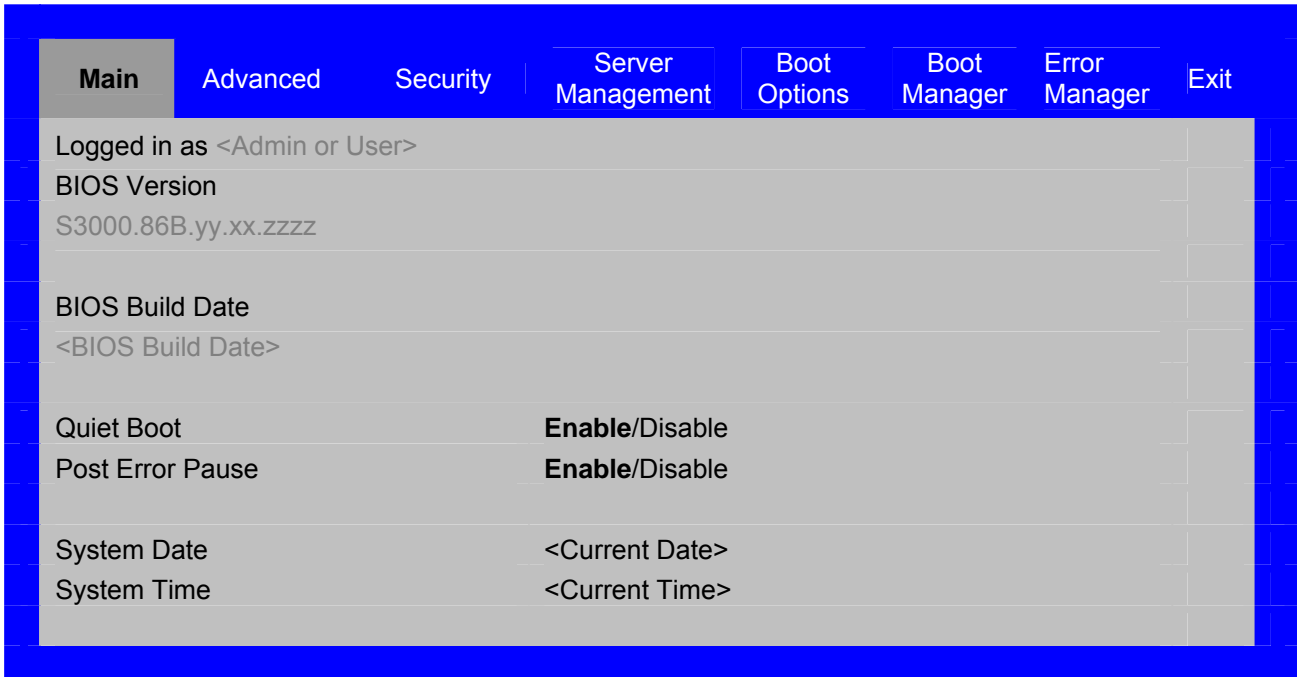

Figure 13. Setup Utility — Main Screen Display

Table 21. Setup Utility — Main Screen Fields

Setup Item	Options	Help Text	Comment
BIOS Version	No entry allowed	N/A	Displays the current BIOS version. yy = major version xx = minor version zzzz = build number
BIOS Build Date	No entry allowed		Displays the current BIOS build date.
Quiet Boot	Enable Disable	If enabled, the BIOS splash screen displays. If disabled, the BIOS POST messages display.	
POST Error Pause	Enable Disable	If enabled, the system waits for user intervention on critical POST errors. If disabled, the system will boot without intervention if possible.	The POST pause the system to load the error manager to review the errors.
System Date	[MM/DD/YYYY]	Month valid values are 1 to 12. Day valid values are 1 to 31. Year valid values are 1998 to 2099.	Help text depends on the subfield selected (Month, Day, or Year).
System Time	[HH:MM:SS]	Hours valid values are 0 to 23. Minutes valid values are 0 to 59. Seconds valid values are 0 to 59.	Help text depends on the subfield selected (Hours, Minutes, or Seconds).

4.3.2.2 Advanced Screen

The Advanced screen provides an access point to configure several options. Configurations are performed on the selected screen—not directly on the Advanced screen.

To access this screen from the Main screen, select Advanced.

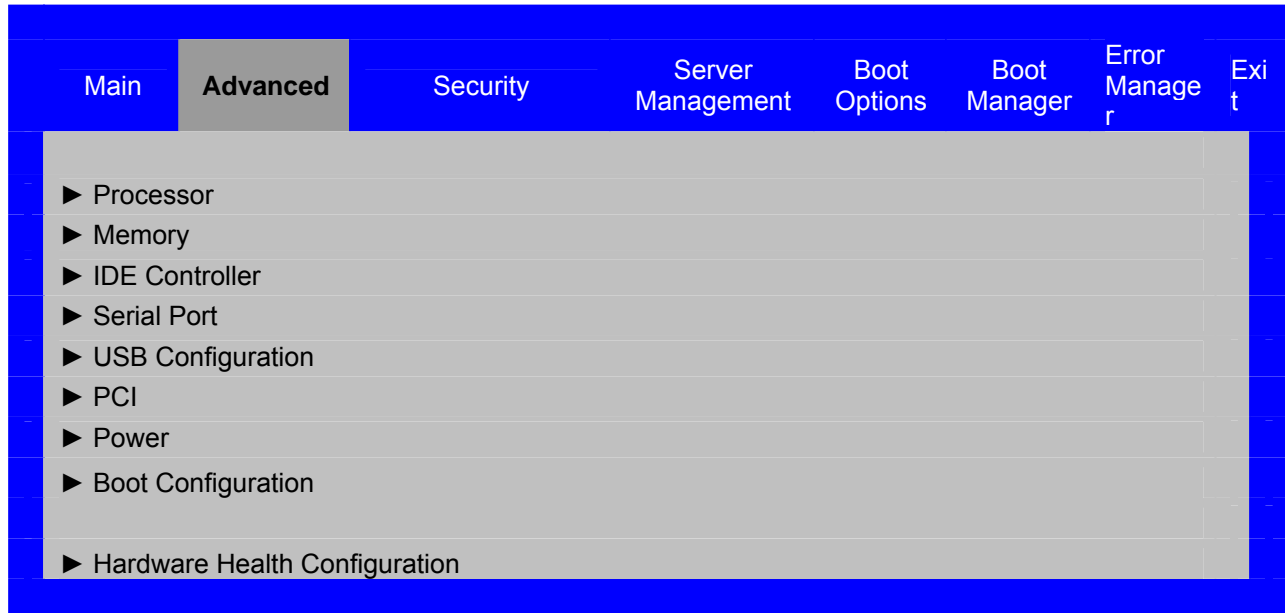

Figure 14. Setup Utility — Advanced Screen Display

4.3.2.2.1 Processor Screen

The Processor screen allows the user to view the processor core frequency, system bus frequency, and enable or disable several processor options. The user can view information about a specific processor.

To access this screen from the Main screen, select Advanced | Processor.

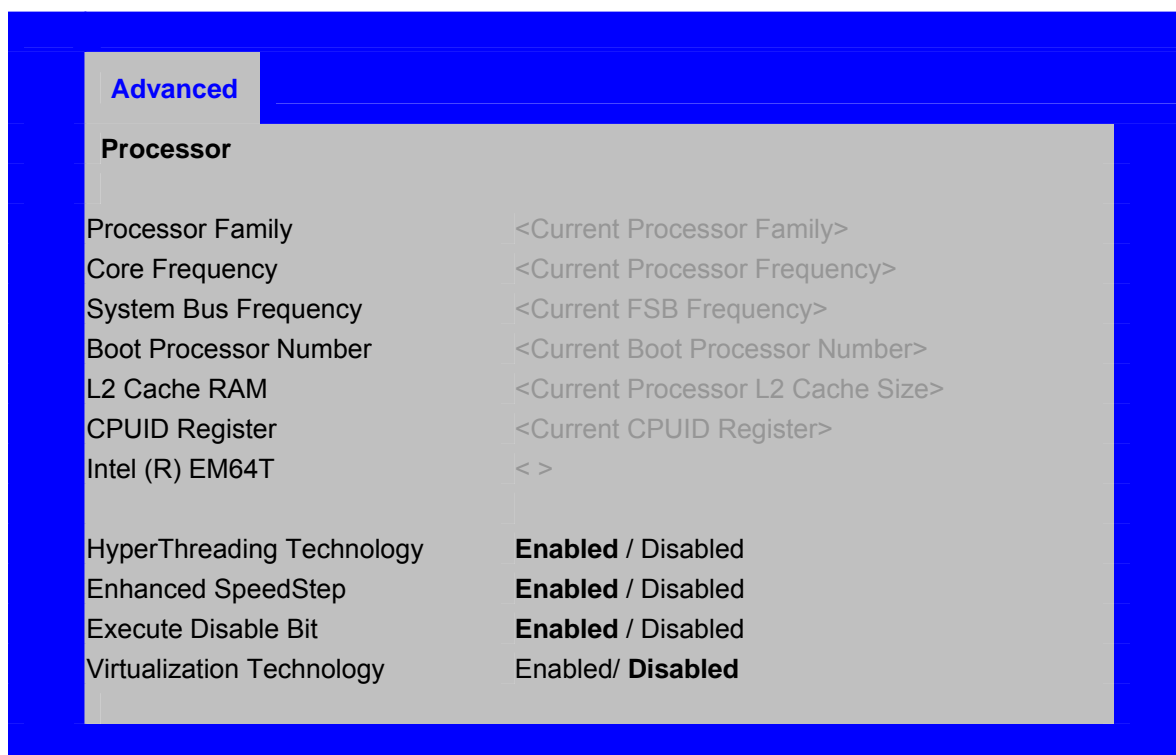

Figure 15. Setup Utility — Processor Configuration Screen Display

Table 22. Setup Utility — Processor Configuration Screen Fields

Setup Item	Options	Help Text	Comment
Processor Family	No entry allowed	N/A	Information only.
Core Frequency	No entry allowed	Frequency at which the processors currently run.	Information only.
System Bus Frequency	No entry allowed	Current frequency of the processor front side bus.	Information only.
Boot Processor Number	No entry allowed		Information only.
L2 Cache RAM	No entry allowed		Information only.
CPUID Register	No entry allowed		Information only.
Intel® EM64T	No entry allowed		Information only.
Hyper-Threading Technology	Enable Disable	Enables or disables Hyper-Threading Technology on the processors. Select Disabled for the Windows 2000 Operation System.	
Enhanced SpeedStep®	Enable Disable	Enhanced Intel SpeedStep® Technology. Select Enable to allow the OS to reduce power consumption.	
Intel® Virtualization Technology	Enable Disable	When enabled, a Virtual Machine Monitor can utilize the additional hardware capabilities provided by Intel® Virtualization Technology.	Only available when the processor has the Intel® VT function.

Setup Item	Options	Help Text	Comment
Execute Disable Bit	Enable Disable	Execute Disable Bit feature (XD bit). Select Enabled to prevent data pages from being used by malicious software to execute code.	

4.3.2.2.2 Memory Screen

The Memory screen provides a place for the user to view details about the installed system memory. On this screen, the user can select an option to open the Configure Memory RAS and Performance screen.

To access this screen from the Main screen, select Advanced | Memory.

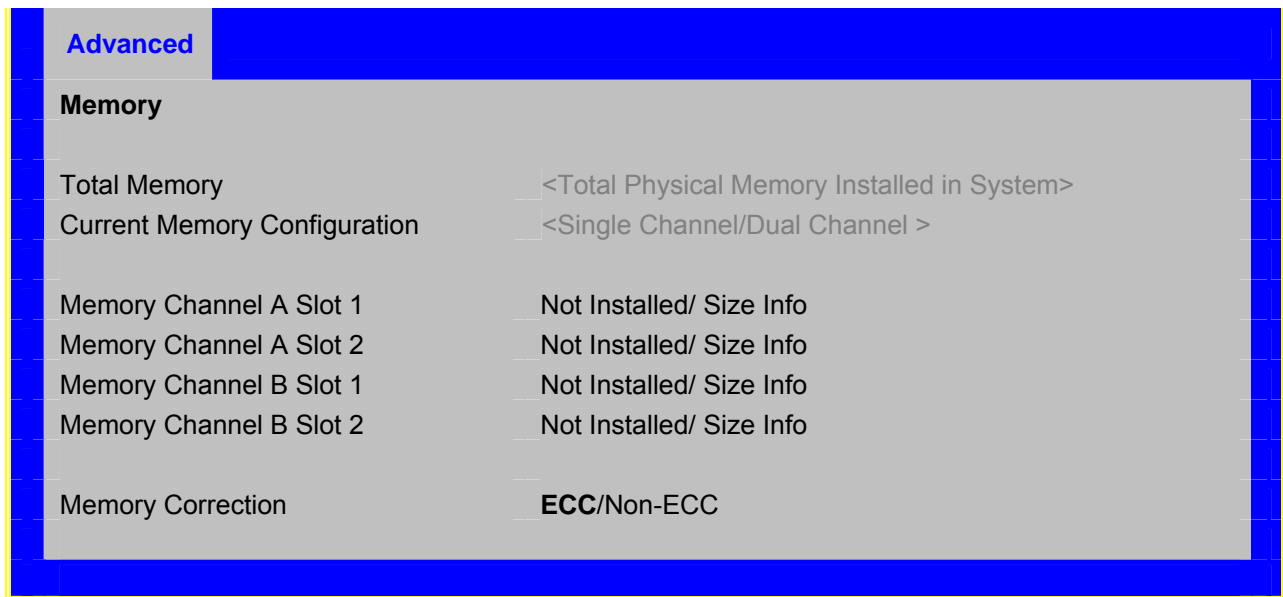

Figure 16. Setup Utility — Memory Configuration Screen Display

Table 23. Setup Utility — Memory Configuration Screen Fields

Setup Item	Options	Help Text	Comment
Total Memory	No entry allowed	N/A	Displays the amount of memory available in the system from the installed DIMMs in units of MB or GB.
Current Configuration	No entry allowed	N/A	Displays one of the following: <ul style="list-style-type: none"> • Single Channel • Dual Channel

Setup Item	Options	Help Text	Comment
DIMM #	No entry allowed	N/A	Displays the state of each DIMM slot present on the board. Each DIMM slot field reflects one of the following possible states: <ul style="list-style-type: none"> • Size Info: There is a DIMM installed in this slot; displays the size information. • Not Installed: No DIMM is installed in this slot.
Memory Correction	ECC Non-ECC	N/A	<ul style="list-style-type: none"> • ECC • Non-ECC

4.3.2.2.3 IDE Controller Screen

The IDE Controller screen provides fields to configure PATA and SATA hard disk drives. It also provides information on the installed hard drives.

To access this screen from the Main screen, select Advanced | IDE Controller.

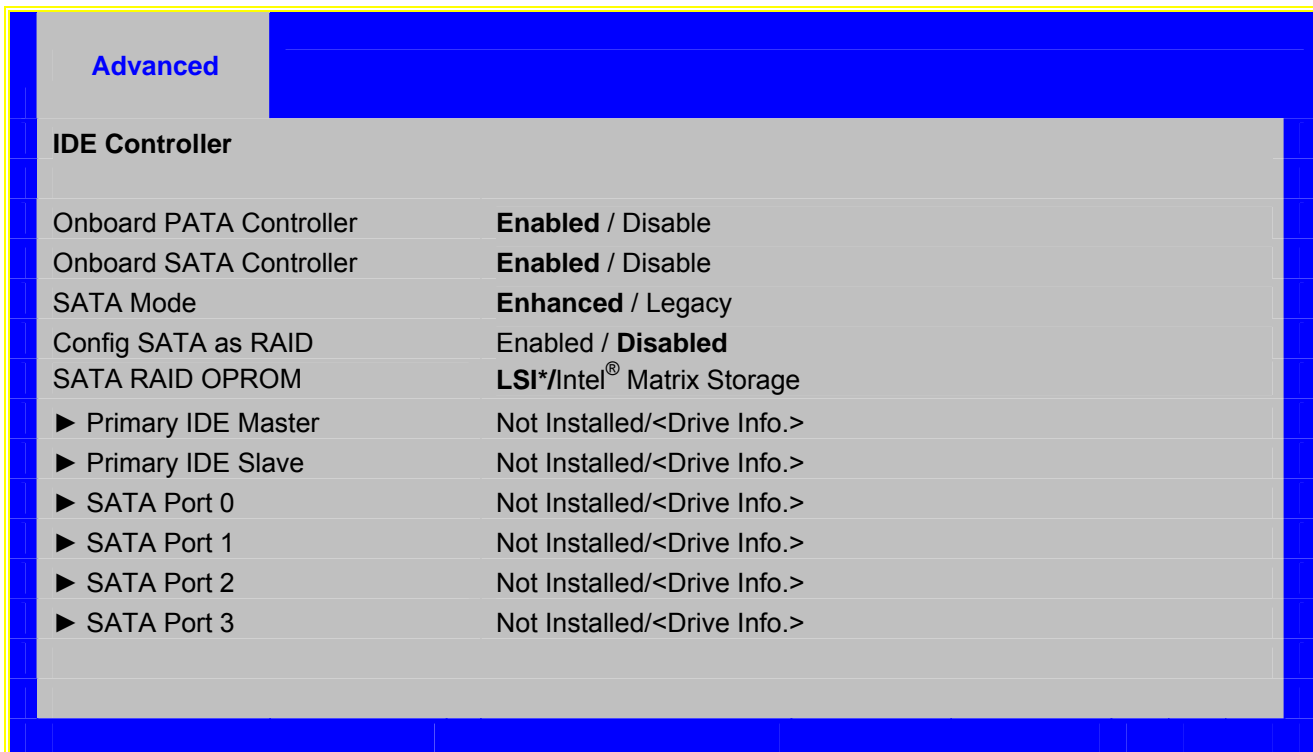

Figure 17. Setup Utility — IDE Controller Configuration Screen Display

Table 24. Setup Utility — ATA Controller Configuration Screen Fields

Setup Item	Option	Help Text	Comment
Onboard PATA Controller	Enable / Disable	Help: Onboard PATA Controller	N/A
Onboard SATA Controller	Enable / Disable	Help: Onboard SATA Controller	When enabled, the SATA controller provides IDE, RAID Mode support.
SATA Mode	Enhanced / Legacy	Help: SATA Mode	<p>In Legacy Mode, the BIOS can enumerate only four drives. It provides four options to choose a mix of SATA and PATA drives.</p> <ul style="list-style-type: none"> - "SATA only": Supports four SATA drives. - "PATA Only": Supports two IDE drives. - "PATA Primary, SATA Secondary": PATA will be the primary channel and SATA Ports 1 and 3 will emulate Secondary ATA channel Master/Slave. - "SATA Primary, PATA secondary": Supports SATA Ports 0, 2 and both IDE ports. <p>In Enhanced Mode, the BIOS is not limited to legacy PATA four-drive limitations, and can enumerate the two PATA drives and four SATA drives (totaling six drives), and can list/boot to the remaining two SATA drives.</p> <p>RAID Mode only supported in "Enhanced" SATA Mode.</p>
Config SATA as RAID	Enable / Disable	Help: Configure SATA as RAID	Only available in Enhanced mode.
SATA RAID OPROM	LSI/Intel® Matrix Storage	Help: Select SATA RAID OPROM	Only available with the "Config SATA as RAID" option
Primary IDE Master	Disabled / Drive information		Information only
Primary IDE Slave	Disabled / Drive information		Information only
SATA Port 0	Disabled / Drive information		This field is unavailable with RAID Mode enabled
SATA Port 1	Disabled / Drive information		This field is unavailable with RAID Mode enabled
SATA Port 2	Disabled / Drive information		This field is unavailable with RAID Mode enabled
SATA Port 3	Disabled / Drive information		This field is unavailable with RAID Mode enabled

4.3.2.2.4 Serial Ports Screen

The Serial Ports screen provides fields to configure the Serial A [COM 1] port.

To access this screen from the Main screen, select Advanced | Serial Port.

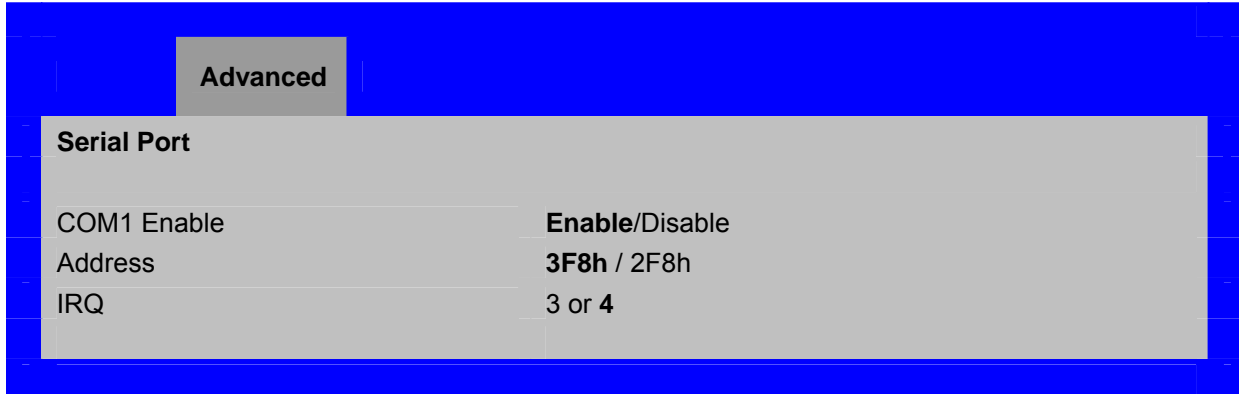

Figure 18. Setup Utility — Serial Port Configuration Screen Display

Table 25. Setup Utility — Serial Ports Configuration Screen Fields

Setup Item	Option	Help Text	Comment
COM1 Enable	Enabled Disabled	Enables or disables the COM1 port.	N/A
Address	3F8h / 2F8h	Selects the base I/O address for COM1.	N/A
IRQ	3 / 4	Selects the Interrupt Request line for COM1.	N/A

4.3.2.2.5 USB Configuration Screen

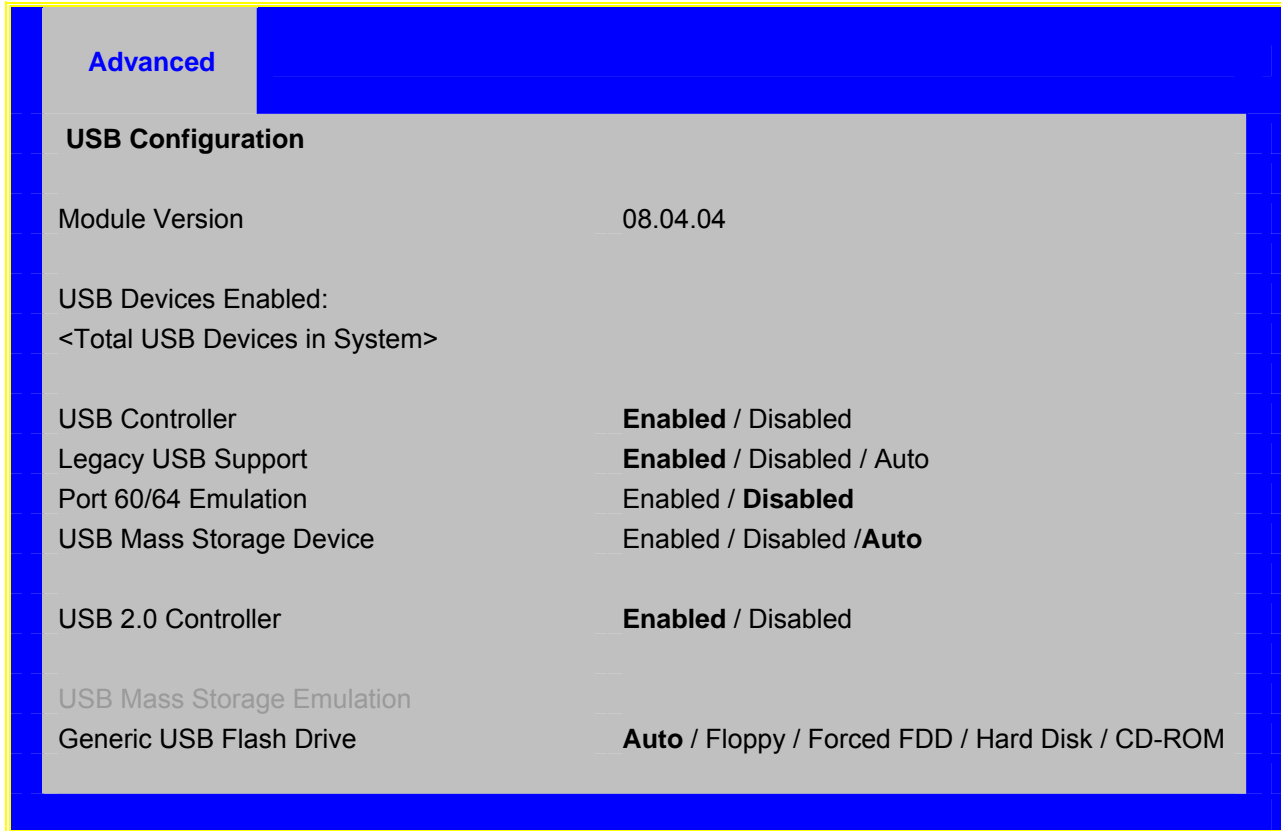

Figure 19. Setup Utility — USB Configuration Screen Display

Table 26. Setup Utility — USB Configuration Screen Fields

Setup Item	Option	Help Text	Comment
Module Version		USB Driver version	Information only
USB Devices Enabled		Displays the number of USB devices in the system	Information only
USB Controller	Enabled Disabled	If Disabled, all the USB controllers power off and are inaccessible by the OS.	N/A
Legacy USB Support	Enabled Disabled Auto	Provides Legacy USB support when enabled. Auto option disables legacy support if no USB devices are connected.	N/A
Port 60/64 Emulation	Enabled / Disabled	Enables I/O Port 60h/64h emulation support. Provides USB keyboard legacy support for non-USB aware OSs	N/A
USB 2.0 Controller	Enabled Disabled	If Disabled the USB 2.0 controllers power off and are inaccessible by the OS.	N/A

Generic USB Flash Drive	Auto Floppy Forced FDD Hard Disk CD-ROM	With the Auto option, a USB device with less than 530MB loads as a floppy drive. The forced FDD option can be used to force an HDD formatted drive to boot as a FDD (i.e.: ZIP drive)	N/A
-------------------------	--	---	-----

4.3.2.2.6 PCI Screen

The PCI Screen provides fields to configure the onboard NIC controllers.

To access this screen from the Main screen, select Advanced | PCI

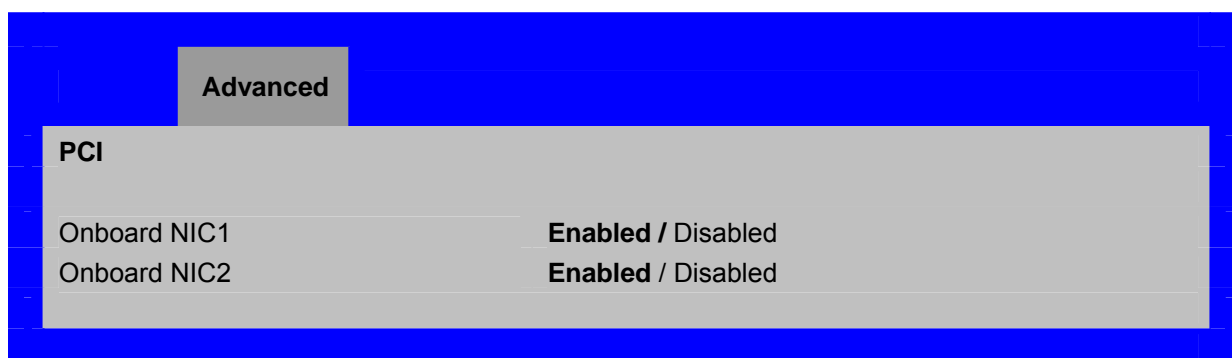

Figure 20. Setup Utility — PCI Configuration Screen Display

Table 27. Setup Utility — PCI Configuration Screen Fields

Setup Item	Option	Help Text	Comment
Onboard NIC1	Enabled Disabled	Enables or Disables the primary Network controller. The name for Onboard NIC1 will be automatically updated according to different SKUs: It is shown as "Intel® 82573E GbE"	N/A
Onboard NIC2	Enabled Disabled	Enables or Disables the secondary Network controller. The name for Onboard NIC2 will be automatically updated according to different SKUs: For LC sku: "Intel® 82541PI GbE". For LX sku: "Intel® 82541PI GbE". The V sku does not have NIC2.	N/A

4.3.2.2.7 Power

The System Power configuration screen provides fields to configure the power state.

To access this screen from the Main screen, select Advanced | Power.

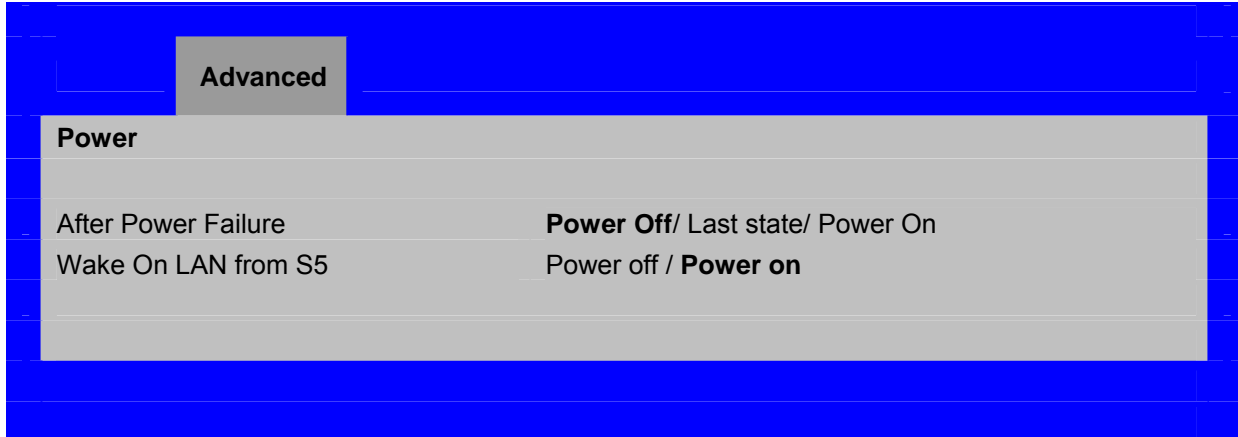

Figure 25. Setup Utility — Power Screen Display

Table 28. Setup Utility — Power Screen Fields

Setup Item	Option	Help Text	Comment
After Power Failure	Power Off Last state Power On	Determines the mode of operation if a power loss occurs. Power off: system will remain off once power is restored. Last state: Restores the system to the state it was in before power failed.	N/A
Wake On LAN from S5	Power off Power on	Determines the action taken when the system power is off and a PCI Power Management wake up event occurs.	N/A

4.3.2.2.8 Boot Configuration

The Boot Configuration screen provides information on the boot devices.

To access this screen from the Main screen, select Advanced | Boot Configuration.

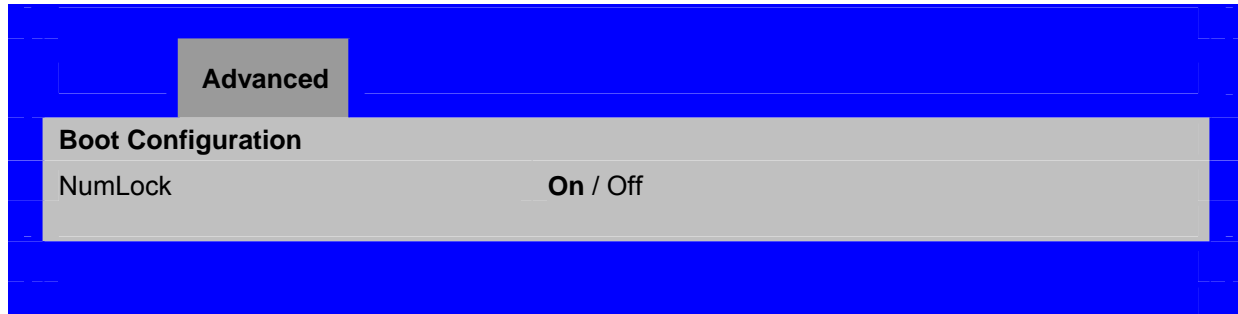

Figure 21. Setup Utility — Boot Configuration Screen Display

Table 29. Setup Utility — Boot Configuration Screen Fields

Setup Item	Option	Help Text	Comment
NumLock	On, Off	Turns keyboard Numlock on or off	System boot with NumLock set to ON or OFF.

4.3.2.2.9 Hardware Monitor

The Hardware Monitor screen provides the configuration and status of the Hardware Monitor.

To access this screen from the Main screen, select Advanced | Hardware Monitor.

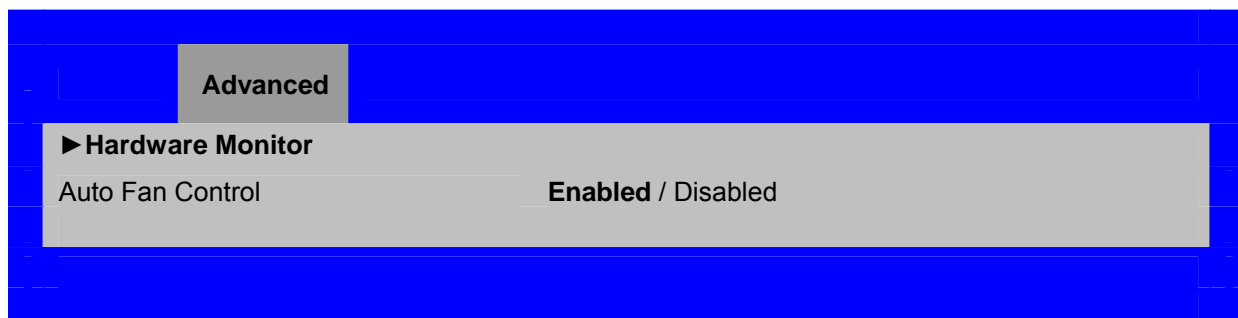

Figure 22. Setup Utility — Hardware Monitor Screen Display

Figure 23 Setup Utility — Hardware Monitor Screen Display

Setup Item	Option	Help Text	Comment
Hardware Monitor	N/A	View the Hardware Monitor information.	See section 4.3.2.3
Auto Fan Control	Enabled / Disabled	Enable / disable auto fan control. If enabled, fan speed are adjusted automatically according to the temperature. If disabled, all fans will run at full speed.	N/A

4.3.2.3 Hardware Status Monitor Screen

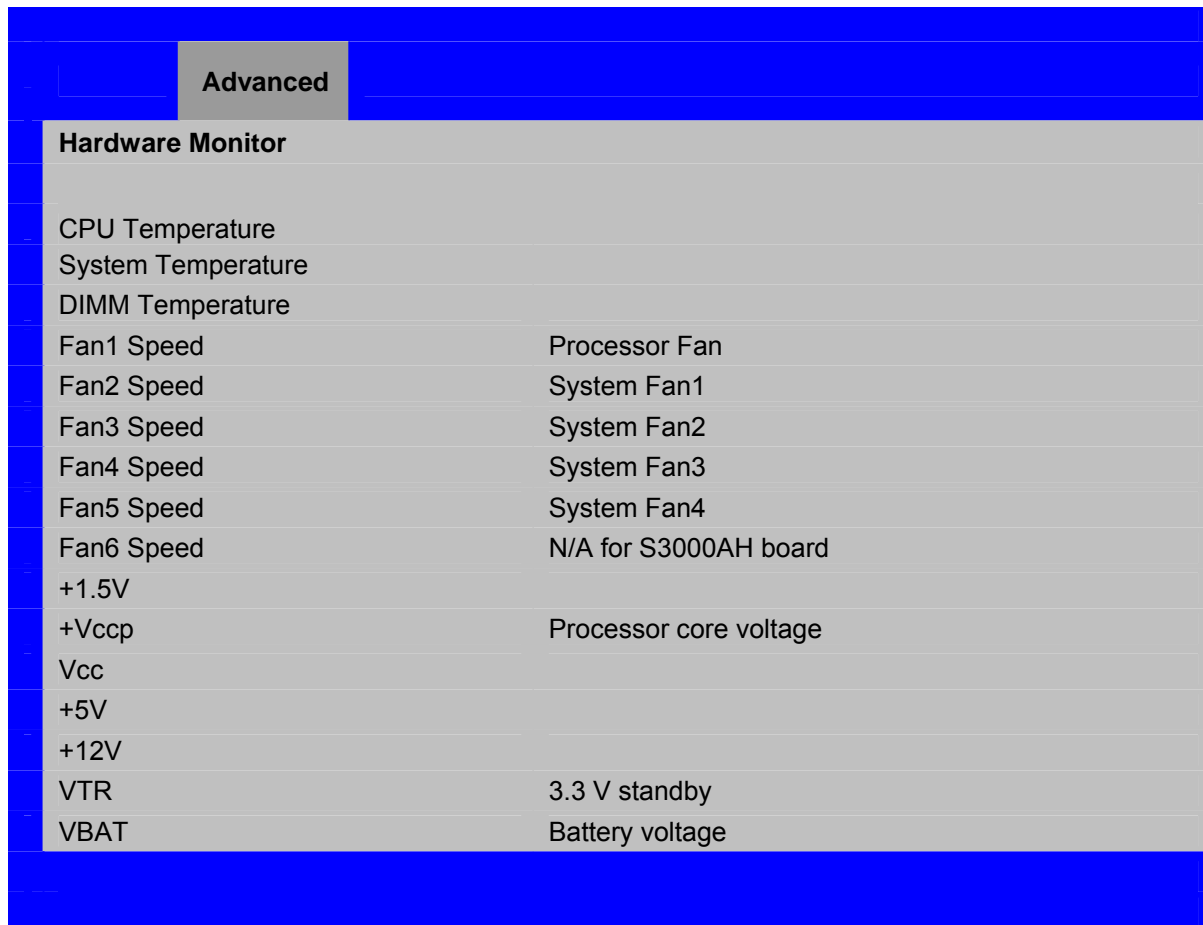

Figure 24 Setup Utility — Hardware Monitor Screen Display

4.3.2.4 Security Screen

The Security screen provides fields to enable and set the user and administrative password.

To access this screen from the Main screen, select the Security option.

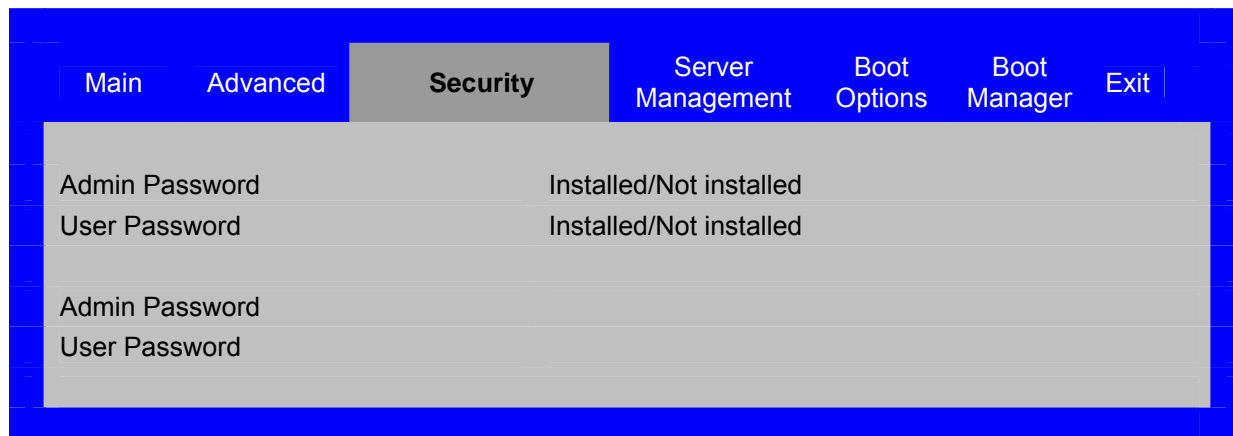

Figure 25. Setup Utility — Security Configuration Screen Display

Table 30. Setup Utility — Security Configuration Screen Fields

Setup Item	Option	Help Text	Comment
Admin Password	Installed Not Installed	Indicates the status of the administrator password	Disabled if the password is blank.
User Password	Installed Not Installed	Indicates the status of the user password	Disabled if the password is blank.
Admin Password	N/A	Sets Administrative password with maximum length of 7 characters	This option provides access to the password setup. Administrator has full access to all setup items. Clearing the Administrator password will also clear the user password. To clear the Administrator password hit the “enter” key and then confirm.
User Password	N/A	Sets personal password with minimum length of 7 characters	Activated with the Administrator Password. This option only protects setup. The User password has limited access.

4.3.2.5 Server Management Screen

The Server Management screen provides fields to configure several server management features. It also provides an access point to the screens for configuring console redirection and displaying system information.

To access this screen from the Main screen, select the Server Management option.

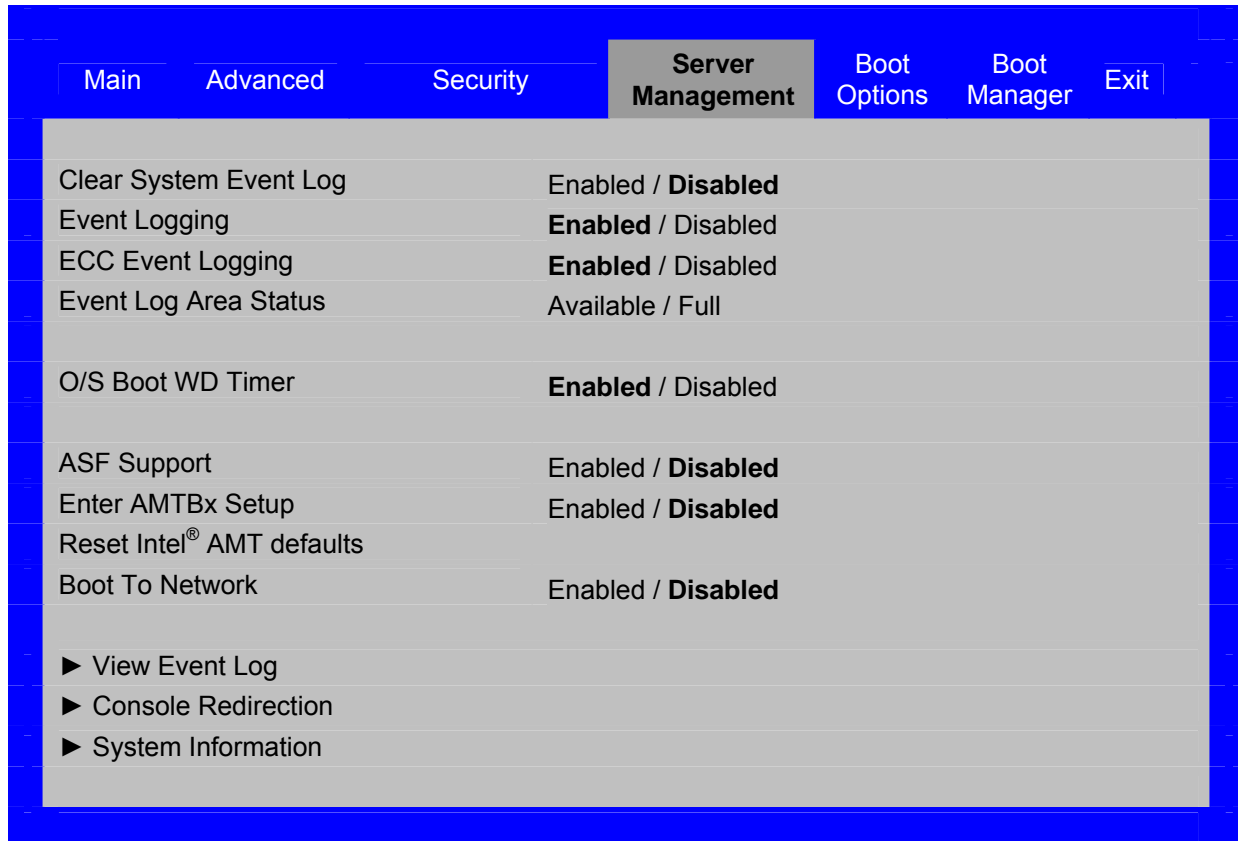

Figure 26. Setup Utility — Server Management Configuration Screen Display

Table 31. Setup Utility — Server Management Configuration Screen Fields

Setup Item	Option	Help Text	Comment
Clear System Event Log	Enabled / Disabled	Clear System Event Log. Reset to Disabled after reboot.	N/A
Event Logging	Enabled / Disabled	Enable / Disable Event Logging	N/A
ECC Event Logging	Enabled / Disabled	Enable / Disable ECC Event Logging	N/A
Event Log Area Status			Information only
O/S Boot WD Timer	Enabled / Disabled	O/S Boot Watchdog Timer	N/A
ASF Support	Enabled / Disabled	Enable ASF Support or not	N/A
Enter AMTBx Setup	Enabled / Disabled	Enable Intel® AMT (Active ManagementTechnology)	This item is unavailable for non-Intel® AMT skus (LC and V skus).
Reset Intel® AMT defaults	N/A	Reset Intel® AMT to its default state.	This item only shows up when “ASF Support” is enabled. Selecting this item will reset the Intel® AMT password.
Boot to Network	Enabled / Disabled	Enable Boot to Network (PXE) or not	N/A

Setup Item	Option	Help Text	Comment
View Event Log	N/A	View the system event log.	Please refer to section 4.3.2.5.1
Console Redirection	N/A	Console Redirection	Please refer to section 4.3.2.5.2
System Information	N/A	System Information	Please refer to section 4.3.2.5.3

4.3.2.5.1 View Event Log

The View Event Log screen displays logged events. Refer to Chapter 6 for events displayed on the screen. The Time of Occurrence displays the last occurrence of one specific event.

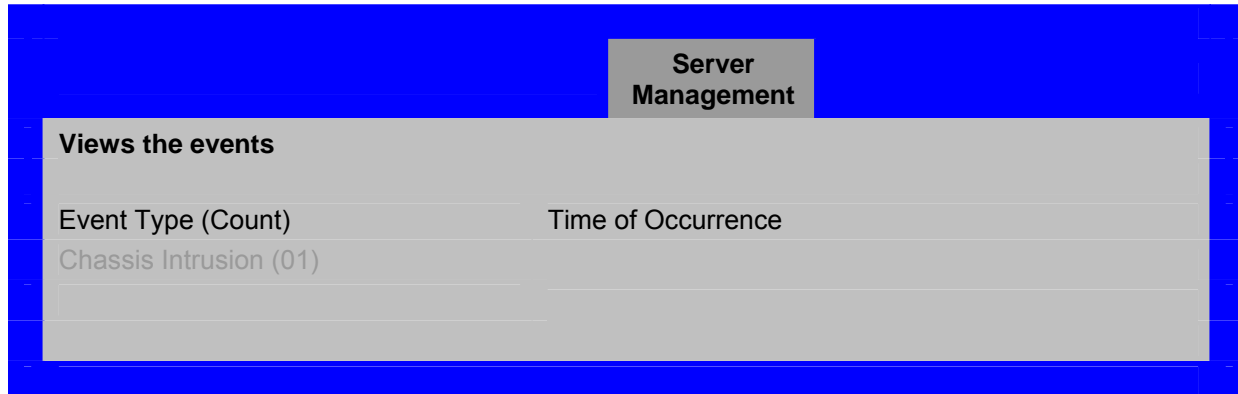

Figure 27. Setup Utility — View Event Log

4.3.2.5.2 Console Redirection Screen

The Console Redirection screen provides a way to enable or disable console redirection and to configure the connection options for this feature.

To access this screen from the Main screen, select Server Management. Select the Console Redirection option from the Server Management screen.

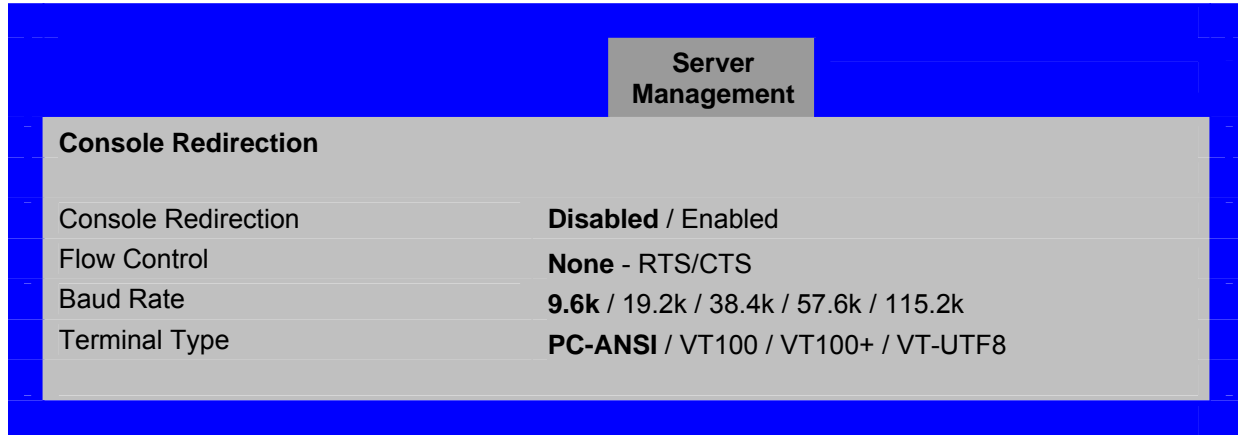

Figure 28. Setup Utility — Console Redirection Screen Display

Table 32. Setup Utility — Console Redirection Configuration Fields

Setup Item	Option	Help Text	Comment
Console Redirection	Disabled Enabled	N/A	Enables or disables the ability to redirect screen data across serial connection
Flow Control	None RTS/CTS	N/A	Sets the handshake protocol the BIOS should expect from the remote console redirection application
Baud Rate	9.6K 19.2K 36.4K 57.6K 115.2K	N/A	Sets the communication speed for the redirection data
Terminal Type	VT100 VT100+ VT-UTF8 PC-ANSI	N/A	Sets the character formatting for the console redirection screen

4.3.2.5.3 Server Management System Information Screen

The Server Management System Information screen provides a place to check system, board and chassis's vendor name, version, and so forth.

To access this screen from the Main screen, select Server Management. Select the System Information option from the Server Management screen.

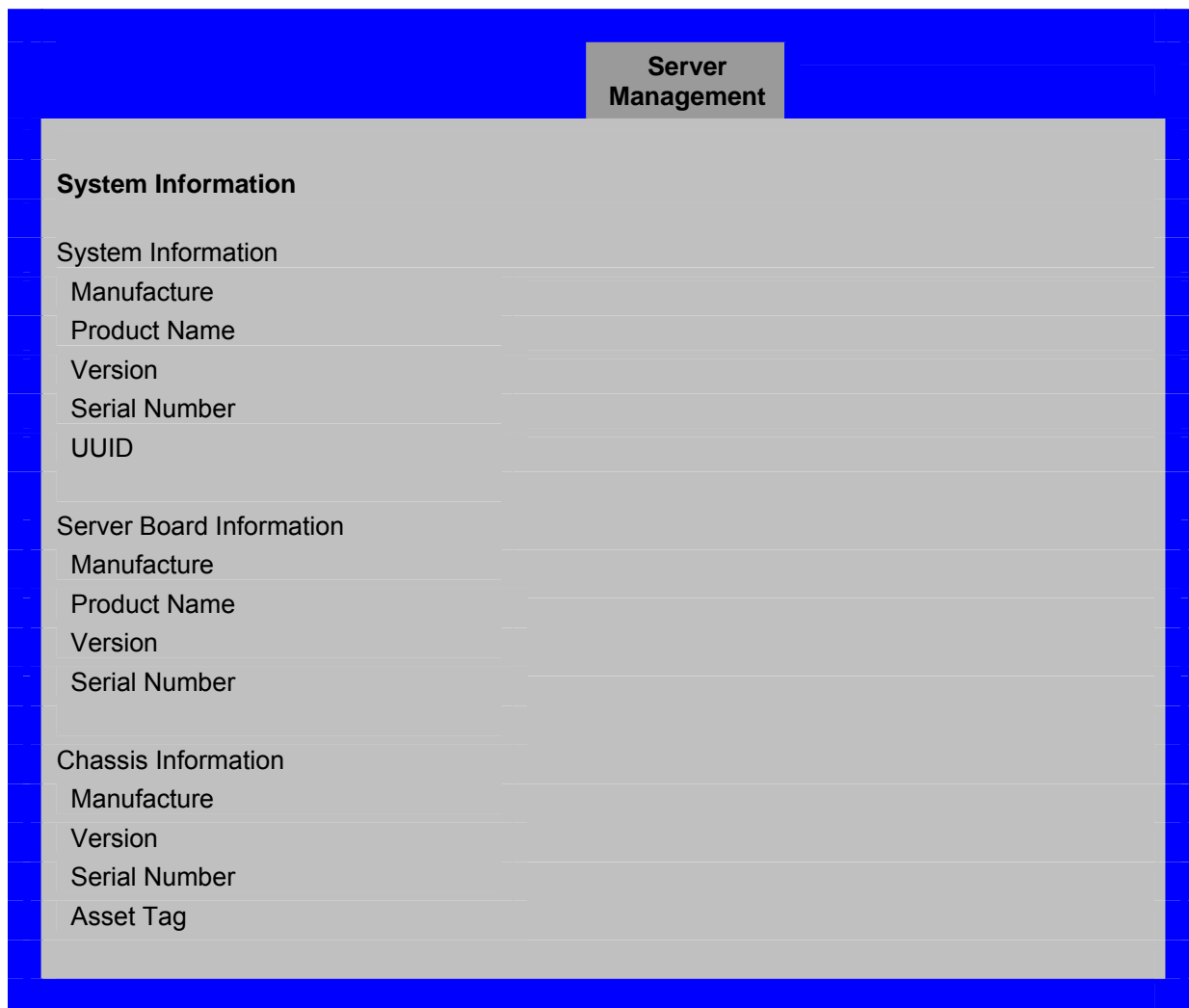

Figure 29. Setup Utility — Server Management System Information Screen Display

Table 33. Setup Utility — Server Management System Information Fields

Setup Item	Option	Help Text	Comment
System Information			Informational Display
Manufacture	Information Only	N/A	N/A
Product Name	Information Only	N/A	N/A
Version	Information Only	N/A	N/A
Serial Number	Information Only	N/A	N/A
UUID	Information Only	N/A	N/A
Server Board Information			Informational Display
Manufacture	Information Only	N/A	N/A
Product Name	Information Only	N/A	N/A

Setup Item	Option	Help Text	Comment
Version	Information Only	N/A	N/A
Serial Number	Information Only	N/A	N/A
Chassis Information			Informational Display
Manufacture	Information Only	N/A	N/A
Version	Information Only	N/A	N/A
Serial Number	Information Only	N/A	N/A
Asset Tag	Information Only	N/A	N/A

4.3.2.6 Boot Options

The Boot Options screen displays all the boot devices and provides the user the ability to set the order of boot options.

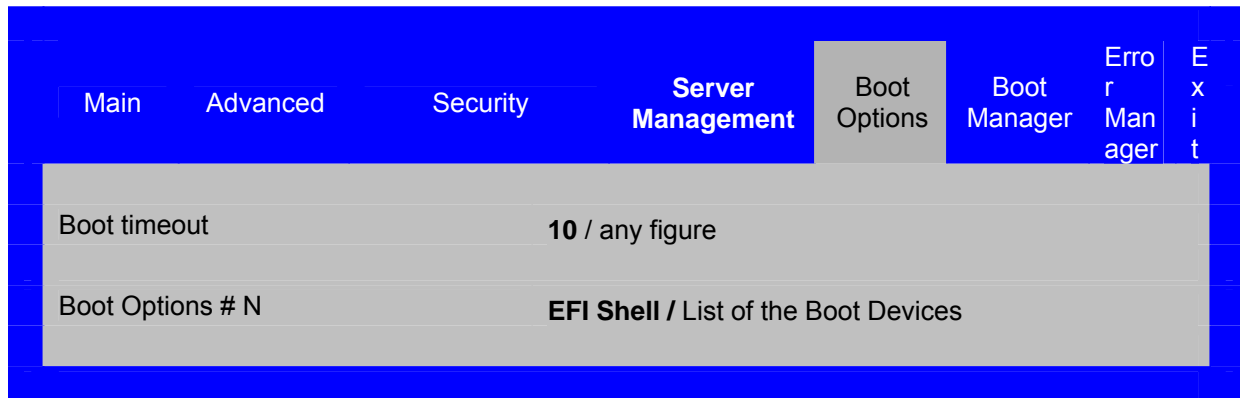

Figure 30. Setup Utility — Boot Options Display

Table 34. Setup Utility — Boot Options Display

Setup Item	Option	Help Text	Comment
Boot Timeout	10	Set the default timeout before system boot. A value of 65535 will disable the timeout completely.	User is able to set the time by simply typing in a figure.
Boot Option #N	EFI Shell / List of the Boot Devices	Set the system boot order	

4.3.2.7 Boot Manager

The Boot Manager screen displays all boot devices. You can access each device without restarting the system or interrupting the boot process.

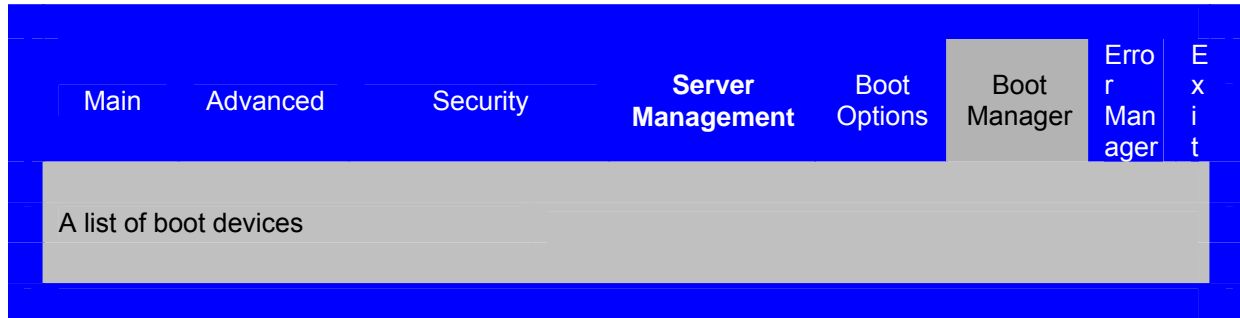

Figure 31. Setup Utility — Boot Manager Display

Table 35. Setup Utility — Error Manager Screen Fields

Setup Item	Option	Help Text	Comment
A List of boot devices	N/A	Boot system using the selected item	Select the boot device and press <Enter>

4.3.2.8 Error Manager Screen

The Error Manager screen displays any errors encountered during POST.

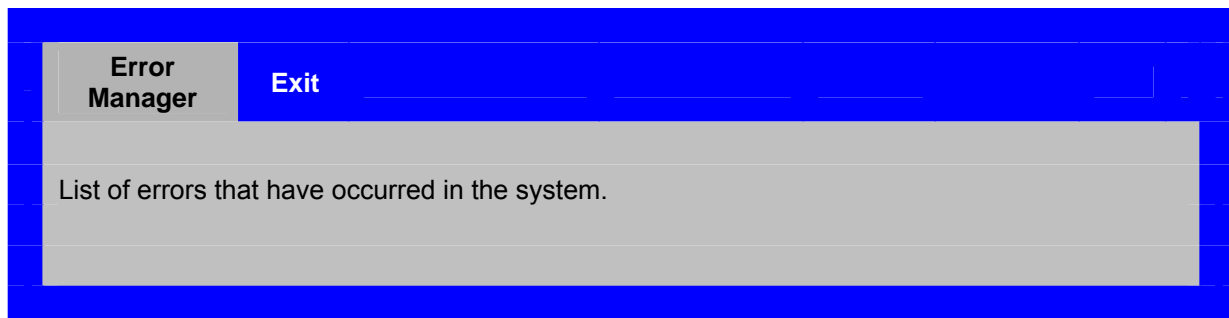

Figure 32. Setup Utility — Error Manager Screen Display

Table 36. Setup Utility — Error Manager Screen Fields

Setup Item	Option	Help Text	Comment
Displays System Errors	N/A	N/A	N/A

4.3.2.9 Exit Screen

The Exit screen allows the user to choose to save or discard the configuration changes made on the other screens. It also provides a method to restore the server to the factory defaults or to save or restore a set of user defined default values. Selecting Restore Defaults restores the system to the default settings, noted in bold in the tables in this chapter. Selecting Restore User Default Values restores the system to the default values that the user saved earlier, instead of the factory defaults.

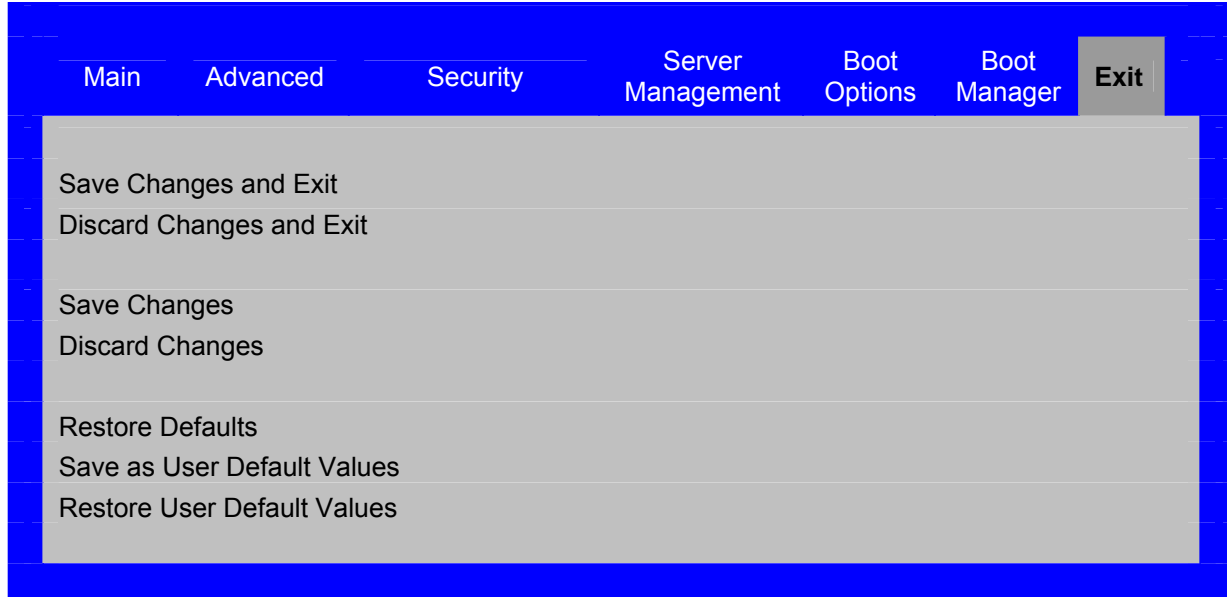

Figure 33. Setup Utility — Exit Screen Display

Table 37. Setup Utility — Exit Screen Fields

Setup Item	Option	Help Text	Comment
Save Changes and Exit	N/A	Apply current Setup values and exit BIOS Setup	User asked for confirmation to make changes
Discard Changes and Exit	N/A	Ignore changes made to values and exit BIOS Setup	User asked for confirmation to make changes
Save Changes	N/A	Apply current values and continue BIOS Setup	User asked for confirmation to make changes
Discard Changes	N/A	Undo changes made to values and continue BIOS Setup	User asked for confirmation to make changes
Restore Defaults	N/A	Restore default BIOS Setup values	User asked for confirmation to make changes
Save User Default Values	N/A	Save current values for restoration later.	N/A
Restore User Default Values	N/A	Restore previously saved user default	User asked for confirmation to make changes

4.4 Loading BIOS Defaults

Different mechanisms exist for resetting the system configuration to the default values. When a request to reset the system configuration is detected, the BIOS loads the default system configuration values during the next POST. To reset the system to the defaults:

- Use the BIOS System Configuration Utility (Setup) to reset the system configuration.
- Generate a reset system configuration request by moving the clear system configuration jumper.

4.5 Multiple Boot Blocks

Two boot blocks are available on this server board. Multiple Boot Blocks fault tolerant realization requires BIOS to:

- Recognize the second boot block and dispatch modules within it.
- Provide a flash update interface (for the utility) that has a fault-tolerant flash update algorithm embedded that provides a set of boot blocks to recover the system settings if the flash update fails.

4.6 Recovery Mode

You can initiate a recovery process by setting the recovery jumper (called Force Recovery), which can be invoked because of flash damage.

To complete a BIOS recover, use an ATAPI-CD. Use the EI-Torito format image to create an ATAPI-CD image for recovery. For more information, refer to Bios release notes.

The recovery media must contain the image file FV_MAIN.FV. The system should also contain a DOS bootable disk (HD, USB drives, CD-ROM, and so forth) which must include the following image files:

- IFLASH32.EXE
- *.CAP
- AUTOEXEC.BAT

The BIOS starts the recovery process by first loading and booting to the recovery image file (FV_MAIN.FV) on the root directory of the inserted ATAPI-CD. This process takes place before any video or console is available. Once the system boots to this recovery image file (FV_MAIN.FV), the user must select the option to boot from the DOS disk, which contains the files in the list above. The process continues by loading and executing the AUTOEXEC.BAT file and the flash update application (IFLASH32.EXE). IFLASH32.EXE requires the supporting BIOS Capsule image file (*.CAP).

Once the recovery process is complete, the user must switch the recovery jumper back to normal operation and restart the system with a power cycle.

Perform the following steps to complete the recovery process:

1. Insert recovery media with the FV_MAIN.FV in the root directory.
2. Insert the disk with the required files (IFLASH32.EXE, AUTOEXEC.BAT, *.CAP).
Note: To save time, combine the files for Steps 1 and 2 onto one disk.
3. Change the recovery mode jumper (BIOS RECV) from normal operation to recovery operation. The details of the jumper are available in the server board EPS.
4. Power on the system.
5. The BIOS POST screen appears and displays the progress. The BIOS continues to boot to DOS from the media.
6. The AUTOEXEC.BAT file loads and initiates the flash update (IFLASH32.EXE) with new capsule file (*.CAP). If the flash update succeeds or fails, a message displays.
7. Once the flash update is completed, put the recovery jumper back to the default position for normal operation.
8. Perform the power cycle.

4.7 Intel® Matrix Storage Manager

Intel® Matrix Storage Manager provides software support for high-performance SATA RAID 0 arrays, fault-tolerant SATA RAID 1 arrays, high-capacity and fault-tolerant SATA RAID 5 arrays, and high performance and fault-tolerant SATA RAID 10 arrays on select supported chipsets using select operating systems. Intel® Matrix Storage Manager is the software that enables Intel® Matrix Storage Technology.

For detailed information and supported operating systems, refer to the following Web site:
<http://support.intel.com/support/chipsets/imsm/>

4.8 Intel® Embedded Server RAID Technology

Intel® Embedded Server RAID Technology supports four SATA ports, which provides a cost-effective way to achieve higher transfer rates and reliability. Intel® Embedded Server RAID Technology supports

- RAID level 0 data striping for improved performance
- RAID level 1 data mirroring for improved data reliability
- RAID level 10 data striping and mirroring for high data transfer rates and data redundancy

Note: You cannot use normal SATA devices when the RAID option is enabled.

5. Error Reporting and Handling

This chapter defines the following error handling features:

- Error Handling and Logging
- Error Messages and Beep Codes

5.1 Error Handling and Logging

This section defines how errors are handled by the system BIOS. It also includes a description of error-logging techniques and error beep codes.

5.1.1 Error Sources and Types

One of the major requirements of server management is to handle system errors correctly and consistently. You can enable and disable system errors individually or as a group. The errors fall into one of the following categories:

- PCI bus errors
- Memory single- and multi-bit errors
- Errors detected during POST, logged as POST errors

The following table shows an error event list.

Table 38. Event List

Event Name	Description	When Error Is Caught
Processor thermal trip of last boot	Processor thermal trip happened on last boot	POST
Memory channel A Multi-bit ECC error	DIMM channel A Multi-bit ECC error	POST / Runtime
Memory channel A Single-bit ECC error	DIMM channel A Single-bit ECC error	POST / Runtime
Memory channel B Multi-bit ECC error	DIMM channel B Multi-bit ECC error	POST / Runtime
Memory channel B Single-bit ECC error	Single-bit ECC error happened on DIMM channel B	POST / Runtime
CMOS battery failure	CMOS battery failure or CMOS clear jumper is set to clear CMOS	POST
CMOS checksum error	CMOS data crushed	POST
CMOS time not set	CMOS time is not set	POST
Keyboard not found	PS/2 KB is not found during POST	POST
Memory size decrease	Memory size is decreased compared with last boot	POST
Chassis intrusion detected	Chassis is open	POST
Bad SPD tolerance	Some fields of the DIMM SPD may not be supported, but could be tolerant by the Memory Reference	POST

Event Name	Description	When Error Is Caught
	Code	
PCI PERR error	PERR error happens on PCI bus	POST / Runtime
PCI SERR error	SERR error happens on PCI bus	POST / Runtime

5.1.2 Error Logging via SMI Handler

The SMI handler handles and logs system level events. The SMI handler pre-processes all system errors, even those that normally generate an NMI.

The SMI handler logs the event to NVRAM. For example, the BIOS programs the hardware to generate SMI on a single-bit memory error and logs the error in the NVRAM in the terms of SMBIOS Type 15. After the BIOS finishes logging the error, it asserts the NMI if needed.

5.1.2.1 PCI Bus Error

The PCI bus defines two error pins, PERR# and SERR#. They report PCI parity errors and system errors, respectively.

In the case of PERR#, the PCI bus master has the option to retry the offending transaction or to report it using SERR#. SERR# reports all other PCI-related errors. All PCI-to-PCI bridges generate SERR# on the primary interface whenever there is SERR# on the secondary side. For more information on the format of the data bytes, refer to Section 5.1.4.

5.1.2.2 PCI Express* Errors

All uncorrectable PCI Express* errors are logged as PCI system errors and promoted to an NMI. All correctable PCI Express errors are logged as PCI parity errors.

5.1.2.3 Memory Errors

The hardware is programmed to generate an SMI on correctable data errors in the memory array. The SMI handler records the error to the NVRAM. The uncorrectable errors may have corrupted the contents of SMRAM. If the SMRAM contents are still valid, the SMI handler logs the error to the NVRAM. For more information on the format of the data bytes, refer to Section 5.1.4.

5.1.3 SMBIOS Type 15

Errors are logged to NVRAM in the terms of SMBIOS Type 15 (System Event Log). Refer to the SMBIOS Specification, version 2.4 for more information. The following section reviews the format of the records.

5.1.4 Logging Format Conventions

The BIOS logs an error into the NVRAM area with record format described in the following table. For more information, refer to the SMBIOS Specification, version 2.4.

Table 39. SMBIOS Type 15 Event Log record format

Offset	Name	Length	Description
00h	EventType	Byte	Specifies the "Type" of event noted in an event-log entry as defined in table
01h	Length	Byte	Specifies the byte length of the event record, including the record's Type and Length fields
02h	Year	Byte	Indicates the time when error is logged
03h	Month	Byte	
04h	Day	Byte	
05h	Hour	Byte	
06h	Minute	Byte	
07h	Second	Byte	
08h	EventData1	DWORD	EFI_STATUS_CODE_TYPE
0Ch	EventData2	DWORD	EFI_STATUS_CODE_VALUE

Table 40. Event Type Definition Table

Value	Description	Used by this platform (Y/N)
00h	Reserved	N
01h	Single-bit ECC memory error	Y
02h	Multi-bit ECC memory error	Y
03h	Parity memory error	N
04h	Bus time-out	N
05h	I/O channel check	N
06h	Software NMI	N
07h	POST memory resize	N
08h	POST error	Y
09h	PCI parity error	Y
0Ah	PCI system error	Y
0Bh	CPU failure	N
0Ch	EISA FailSafe timer time-out	N
0Dh	Correctable memory log disabled	N
0Eh	Logging disabled for a specific Event Type – too many errors of the same type received in a short amount of time	N
0Fh	Reserved	N
10h	System limit exceeded (i.e.: voltage or temperature threshold exceeded)	Y
11h	Asynchronous hardware timer expired and issued a system reset	N
12h	System configuration information	N
13h	Hard disk information	N
14h	System reconfigured	N

15h	Uncorrectable CPU-complex error	N
16h	Log area reset/cleared	Y
17h	System boot (if implemented, this log entry is guaranteed to be the first one written on any system boot)	N
18h-7Fh	Unused (available for assignment by SMBIOS Specification Version 2.3.4)	N
80h-FEh	Available for system and OEM-specific assignments	Y
FFh	End-of-log. When an application searches through the event-log records the end of the log is identified when a log record with this type is found.	Y

For information on the `EFI_STATUS_CODE_TYPE` and `EFI_STATUS_CODE_VALUE` definitions, refer to the *Intel Platform Innovation Framework for EFI Status Codes Specification*, version 0.92.

The errors displayed on the BIOS Setup screen in Server Management / View EventLog menu display in the following format:

```
EventName (times)      Time of Occurrence
```

Table 38 lists the possible Event Names. The Time of Occurrence is the last time the event occurred.

5.2 Error Messages and Error Codes

The system BIOS displays error messages on the video screen. Before video initialization, beep codes inform the user of errors. POST error codes appear in the event log. The BIOS displays POST error codes on the video monitor.

5.2.1 Diagnostic LEDs

During the system boot process, the BIOS executes several platform configuration processes, each of which is assigned a specific hex POST code number. As each configuration routine is started, the BIOS displays the POST code on the POST code diagnostic LEDs found on the back edge of the server board. To assist in troubleshooting a system hang during the POST process, you can use the diagnostic LEDs to identify the last POST process executed.

Each POST code is represented by a combination of colors from the four LEDs. The LEDs are capable of displaying three colors: green, red, and amber. The POST codes are divided into an upper nibble and a lower nibble. A red LED represents each bit in the upper nibble and a green LED represents each bit in the lower nibble. If both bits are set in the upper and lower nibbles then both red and green LEDs light up, resulting in an amber color. If both bits are clear, then the LED is off.

In the following example below, the BIOS sends a value of ACh to the diagnostic LED decoder. The LEDs are decoded as follows:

- Red bits = 1010b = Ah
- Green bits = 1100b = Ch

Since the red bits correspond to the upper nibble and the green bits correspond to the lower nibble, the two together become ACh.

Table 41. POST Progress Code LED Example

LEDs	8h		4h		2h		1h	
	Red	Green	Red	Green	Red	Green	Red	Green
ACh	1	1	0	1	1	0	0	0
Result	Amber		Green		Red		Off	
	MSB				LSB			

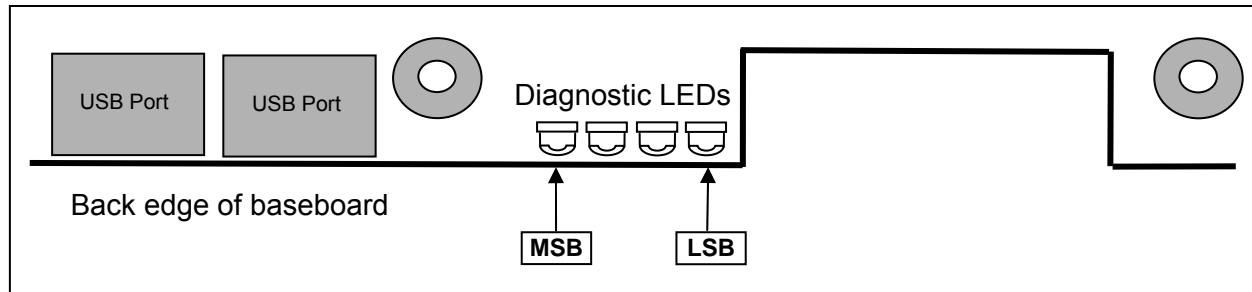

Figure 19. Location of Diagnostic LEDs on Server Board

5.2.2 POST Code Checkpoints

Table 42. POST Code Checkpoints

Checkpoint	Diagnostic LED Decoder				Description
	G=Green, R=Red, A=Amber				
	MSB			LSB	
Host Processor					
0x10h	OFF	OFF	OFF	R	Power-on initialization of the host processor (bootstrap processor)
0x11h	OFF	OFF	OFF	A	Host processor cache initialization (including AP)
0x12h	OFF	OFF	G	R	Starting application processor initialization
0x13h	OFF	OFF	G	A	SMM initialization
Chipset					
0x21h	OFF	OFF	R	G	Initializing a chipset component
Memory					
0x22h	OFF	OFF	A	OFF	Reading configuration data from memory (SPD on DIMM)
0x23h	OFF	OFF	A	G	Detecting presence of memory
0x24h	OFF	G	R	OFF	Programming timing parameters in the memory controller
0x25h	OFF	G	R	G	Configuring memory parameters in the memory controller

Checkpoint	Diagnostic LED Decoder				Description
	G=Green, R=Red, A=Amber				
	MSB			LSB	
0x26h	OFF	G	A	OFF	Optimizing memory controller settings
0x27h	OFF	G	A	G	Initializing memory, such as ECC init
0x28h	G	OFF	R	OFF	Testing memory
PCI Bus					
0x50h	OFF	R	OFF	R	Enumerating PCI bus
0x51h	OFF	R	OFF	A	Allocating resources to PCI buses
0x52h	OFF	R	G	R	Hot-Plug PCI controller initialization
0x53h	OFF	R	G	A	Reserved for PCI bus
0x54h	OFF	A	OFF	R	Reserved for PCI bus
0x55h	OFF	A	OFF	A	Reserved for PCI bus
0x56h	OFF	A	G	R	Reserved for PCI bus
0x57h	OFF	A	G	A	Reserved for PCI bus
USB					
0x58h	G	R	OFF	R	Resetting USB bus
0x59h	G	R	OFF	A	Reserved for USB devices
ATA / ATAPI / SATA					
0x5Ah	G	R	G	R	Begin PATA / SATA bus initialization
0x5Bh	G	R	G	A	Reserved for ATA
SMBUS					
0x5Ch	G	A	OFF	R	Resetting SMBUS
0x5Dh	G	A	OFF	A	Reserved for SMBUS
Local Console					
0x70h	OFF	R	R	R	Resetting the video controller (VGA)
0x71h	OFF	R	R	A	Disabling the video controller (VGA)
0x72h	OFF	R	A	R	Enabling the video controller (VGA)
Remote Console					
0x78h	G	R	R	R	Resetting the console controller
0x79h	G	R	R	A	Disabling the console controller
0x7Ah	G	R	A	R	Enabling the console controller
Keyboard (PS/2 or USB)					
0x90h	R	OFF	OFF	R	Resetting the keyboard
0x91h	R	OFF	OFF	A	Disabling the keyboard
0x92h	R	OFF	G	R	Resetting the keyboard
0x93h	R	OFF	G	A	Enabling the keyboard
0x94h	R	G	OFF	R	Clearing keyboard input buffer
0x95h	R	G	OFF	A	Instructing keyboard controller to run Self Test (PS/2 only)
Mouse (PS/2 or USB)					
0x98h	A	OFF	OFF	R	Resetting the mouse
0x99h	A	OFF	OFF	A	Detecting the mouse
0x9Ah	A	OFF	G	R	Detecting the presence of mouse
0x9Bh	A	OFF	G	A	Enabling the mouse
Fixed Media					

Checkpoint	Diagnostic LED Decoder				Description
	G=Green, R=Red, A=Amber				
	MSB			LSB	
0xB0h	R	OFF	R	R	Resetting fixed media device
0xB1h	R	OFF	R	A	Disabling fixed media device
0xB2h	R	OFF	A	R	Detecting presence of a fixed media device (IDE hard drive detection, etc.)
0xB3h	R	OFF	A	A	Enabling / configuring a fixed media device
Removable Media					
0xB8h	A	OFF	R	R	Resetting removable media device
0xB9h	A	OFF	R	A	Disabling removable media device
0xBAh	A	OFF	A	R	Detecting presence of a removable media device (IDE CD-ROM detection, etc.)
0xBCh	A	G	R	R	Enabling / configuring a removable media device
Boot Device Selection					
0xD0	R	R	OFF	R	Trying boot device selection
0xD1	R	R	OFF	A	Trying boot device selection
0xD2	R	R	G	R	Trying boot device selection
0xD3	R	R	G	A	Trying boot device selection
0xD4	R	A	OFF	R	Trying boot device selection
0xD5	R	A	OFF	A	Trying boot device selection
0xD6	R	A	G	R	Trying boot device selection
0xD7	R	A	G	A	Trying boot device selection
0xD8	A	R	OFF	R	Trying boot device selection
0xD9	A	R	OFF	A	Trying boot device selection
0XDA	A	R	G	R	Trying boot device selection
0xDB	A	R	G	A	Trying boot device selection
0xDC	A	A	OFF	R	Trying boot device selection
0xDE	A	A	G	R	Trying boot device selection
0xDF	A	A	G	A	Trying boot device selection
Pre-EFI Initialization (PEI) Core					
0xE0h	R	R	R	OFF	Started dispatching an PEIM
0xE1h	R	R	R	G	Completed dispatching an PEIM
0xE2h	R	R	A	OFF	Initial memory found, configured, and installed correctly
0xE3h	R	R	A	G	Reserved for initialization module use (PEIM)
Driver Execution Environment (DXE) Core					
0xE4h	R	A	R	OFF	Entered EFI driver execution phase (DXE)
0xE5h	R	A	R	G	Reserved for DXE core use
0xE6h	R	A	A	OFF	Started connecting drivers
0xEBh	A	R	A	G	Started dispatching a driver
0xECh	R	A	A	OFF	Completed dispatching a driver
DXE Drivers					
0xE7h	R	A	A	G	Waiting for user input
0xE8h	A	R	R	OFF	Checking password
0xE9h	A	R	R	G	Entering BIOS setup
0xEAh	A	R	A	OFF	Flash Update

Checkpoint	Diagnostic LED Decoder				Description
	G=Green, R=Red, A=Amber				
	MSB			LSB	
0xEEh	A	A	A	OFF	Calling Int 19 (one beep unless silent boot is enabled)
0xEFh	A	A	A	G	Reserved for DXE Drivers use
Runtime Phase / EFI Operating System Boot					
0xF4h	R	A	R	R	Entering Sleep state
0xF5h	R	A	R	A	Exiting Sleep state
0xF8h	A	R	R	R	Operating system has requested EFI to close boot services (ExitBootServices () has been called)
0xF9h	A	R	R	A	Operating system has switched to virtual address mode (SetVirtualAddressMap () has been called)
0xFAh	A	R	A	R	Operating system has requested the system to reset (ResetSystem () has been called)
Pre-EFI Initialization Module (PEIM) / Recovery					
0x30h	OFF	OFF	R	R	Crisis recovery has been initiated because of a user request
0x31h	OFF	OFF	R	A	Crisis recovery has been initiated by software (corrupt flash)
0x34h	OFF	G	R	R	Loading crisis recovery capsule
0x35h	OFF	G	R	A	Handing off control to the crisis recovery capsule
0x3Fh	G	G	A	A	Unable to complete crisis recovery

5.2.3 POST Error Messages and Handling

Whenever possible, the BIOS outputs the current boot progress codes on the video screen. Progress codes are 32-bit quantities plus optional data. The 32-bit numbers include class, subclass, and operation information. The class and subclass fields point to the type of hardware to initialize. The operation field represents the specific initialization activity. Based on the data bit availability to display progress codes, a progress code can be customized to fit the data width. The higher the data bit, the higher the granularity of information that can be sent on the progress port. The progress codes may be reported by the system BIOS or option ROMs.

The Response section in the following table includes two types:

- **Pause:** The Error Manager displays the message, an error may be logged to the NVRAM, and user input is required to continue. The user can take immediate corrective action or choose to continue booting.
- **Halt:** The Error Manager displays the message, an error is logged to the NVRAM and the system cannot boot unless the error is resolved. The user needs to replace the faulty part and restart the system.

Table 43. POST Error Messages and Handling

Error Message	Response	Log Error
CMOS date / time not set	Pause	Y
Configuration cleared by jumper	Pause	Y
Configuration default loaded	Pause	N
Password check failed	Halt	N
PCI resource conflict	Pause	N
Insufficient memory to shadow PCI ROM	Pause	N
Processor thermal trip error on last boot	Pause	Y

5.2.4 POST Error Beep Codes

The following table lists POST error beep codes. Prior to system Video initialization, BIOS uses these beep codes to inform users of error conditions. The beep code is followed by a user visible code on POST Progress LEDs.

Table 44. POST Error Beep Codes

Beeps	Error Message	Description
3	Memory error	System detects a fatal error related to the memory stops the Post progress

5.2.5 POST Error Pause Option

When a "Pause" POST error occurs, the BIOS enters the error manager and waits for the user to press an appropriate key before booting the operating system or entering BIOS Setup.

The user can override this option by setting "POST Error Pause" to "disabled" in the BIOS setup Main menu page. When the "POST Error Pause" option is set to "disabled", the system boots the operating system without user-intervention. The default value is set to "enabled".

6. Connectors and Jumper Blocks

6.1 Power Connectors

6.1.1 Main Power Connector

The following table defines the pin-out of the main power connector.

Table 45. Power Connector Pin-out (J4G1)

Pin	Signal	18 AWG Color	Pin	Signal	18 AWG Color
1*	+3.3VDC 3.3V RS	Orange Orange (24AWG)	13	+3.3VDC	Orange
2	+3.3VDC	Orange	14	-12VDC	Blue
3*	COM COM RS	Black Black (24AWG)	15	COM	Black
4*	+5VDC 5V RS	Red Red (24AWG)	16	PSON#	Green
5	COM	Black	17	COM	Black
6	+5VDC	Red	18	COM	Black
7	COM	Black	19	COM	Black
8	PWR OK	Gray	20	Reserved	N.C.
9	5 VSB	Purple	21	+5VDC	Red
10	+12V3	Yellow	22	+5VDC	Red
11	+12V3	Yellow	23	+5VDC	Red
12	+3.3VDC	Orange	24	COM	Black

Table 46. Auxiliary CPU Power Connector Pin-out (J9B2)

Pin	Signal	18 AWG color	Pin	Signal	18 AWG Color
1	COM	Black	5*	+12V1 12V1 RS	White Yellow (24AWG)
2	COM	Black	6	+12V1	White
3	COM	Black	7	+12V2	Brown
4	COM	Black	8*	+12V2 12V2 RS	Brown Yellow (24AWG)

6.2 Intel® Adaptive Slot

The Intel® Adaptive super slot supports one PCI Express* x8 and one PCI-X* 66/100 interface. PCI x8 is available as a standard slot or through a PCI Express riser card. PCI-X is only available through a PCI-X riser card, which is only available on the S3000AHLX SKU.

Table 47. Intel® Adaptive Slot Pin-out (J4B2)

Pin-Side B	PCI Spec Signal	Description	Pin-Side A	PCI Spec Signal	Description
1	12V	N/A	1	Presnt1#	
2	12V	N/A	2	12V	
3	12V	N/A	3	12V	
4	GND	N/A	4	GND	
5	SMCLK	N/A	5	JTAG-TCK	
6	SMDATA	N/A	6	JTAG-TDI	
7	GND	N/A	7	JTAG-TDO	
8	3.3V	N/A	8	JTAG-TMS	
9	JTAG-TRST#	N/A	9	3.3V	
10	3.3VAux	N/A	10	3.3V	
11	Wake#	N/A	11	PERST#	
KEY	KEY	N/A	KEY	KEY	
KEY	KEY	N/A	KEY	KEY	
12	RSVD	N/A	12	GND	
13	GND	N/A	13	REFCLK1+	
14	HSOp(0)	N/A	14	REFCLK1+	
15	HSOn(0)	N/A	15	GND	
16	GND	N/A	16	HSIp(0)	
17	Present2#	N/A	17	HSIn(0)	
18	GND	1X end	18	GND	
19	HSOp(1)	N/A	19	RSVD	
20	HSOn(1)	N/A	20	GND	
21	GND	N/A	21	HSIp(1)	
22	GND	N/A	22	HSIn(1)	
23	HSOp(2)	N/A	23	GND	
24	HSOn(2)	N/A	24	GND	
25	GND	N/A	25	HSIp(2)	
26	GND	N/A	26	HSIn(2)	
27	HSOp(3)	N/A	27	GND	
28	HSOn(3)	N/A	28	GND	
29	GND	N/A	29	HSIp(3)	
30	RSVD	N/A	30	HSIn(3)	
31	PRSENT2#	N/A	31	GND	
32	GND	4X end	32	REFCLK2+	Second x4 clock
33	HSOp(4)	N/A	33	REFCLK2+	Second x4 clock

Intel® Server Boards S3000AHLX, S3000AH, and S3000AHV TPS

Pin-Side B	PCI Spec Signal	Description	Pin-Side A	PCI Spec Signal	Description
34	HSON(4)	N/A	34	GND	
35	GND	N/A	35	HSIp(4)	
36	GND	N/A	36	HSIn(4)	
37	HOp(5)	N/A	37	GND	
38	HSON(5)	N/A	38	GND	
39	GND	N/A	39	HSIp(5)	
40	GND	N/A	40	HSIn(5)	
41	HOp(6)	N/A	41	GND	
42	HSON(6)	N/A	42	GND	
43	GND	N/A	43	HSIp(6)	
44	GND	N/A	44	HSIn(6)	
45	HOp(7)	N/A	45	GND	
46	HSON(7)	N/A	46	GND	
47	GND	N/A	47	HSIp(7)	
48	PRSNT2#	N/A	48	HSIn(7)	
49	GND	8X end	49	GND	
KEY	KEY	Blocks a x16 PCI Express* board	KEY	KEY	Allows a x8 to be used instead
KEY	KEY	Blocks a x16 PCI Express* board	KEY	KEY	
50	-12V	N/A	50	12V	
51	+5V	N/A	51	INTB#	
52	INTD#	N/A	52	+5V	
53	+5V	N/A	53	+5V	
54	+5V	N/A	54	+5V	
55	INTA#	N/A	55	INTC#	
56	GND	N/A	56	GND	
57	CLK3	N/A	57	REQ3#	
58	GND	N/A	58	GND	
59	CLK2	N/A	59	GNT3#	
60	GND	N/A	60	GND	
61	REQ2#	N/A	61	RST#	
62	GND	N/A	62	+5V	
63	GND	N/A	63	RSVD	
64	CLK1	N/A	64	GND	
65	GND	N/A	65	GNT2#	
66	REQ1#	N/A	66	+3.3V	
67	+3.3V	N/A	67	GNT1#	
68	PME2#	N/A	68	GND	
69	AD[31]	N/A	69	PME1#	
70	AD[29]	N/A	70	PME3#	
71	GND	N/A	71	AD[30]	
72	AD[27]	N/A	72	+3.3V	

Pin-Side B	PCI Spec Signal	Description	Pin-Side A	PCI Spec Signal	Description
73	AD[25]	N/A	73	AD[28]	
74	+3.3V	N/A	74	AD[26]	
75	C/BE[3]#	N/A	75	GND	
76	AD[23]	N/A	76	AD[24]	
77	GND	N/A	77	AD[22]	
78	AD[21]	N/A	78	+3.3V	
79	AD[19]	N/A	79	AD[20]	
80	+3.3V	N/A	80	AD[18]	
81	AD[17]	N/A	81	GND	
82	C/BE[2]#	N/A	82	AD[16]	
83	GND	N/A	83	PCI-XCAP	
84	IRDY#	N/A	84	+3.3V	
85	+3.3V	N/A	85	FRAME#	
86	DEVSEL#	N/A	86	GND	
87	GND	N/A	87	TRDY#	
88	LOCK#	N/A	88	GND	
89	PERR#	N/A	89	STOP#	
90	+3.3V	N/A	90	+3.3V	
91	3.3V	N/A	91	SERR#	
92	C/BE[1]#	N/A	92	GND	
93	AD[14]	N/A	93	PAR	
94	GND	N/A	94	AD[15]	
95	AD[12]	N/A	95	+3.3V	
96	AD[10]	N/A	96	AD[13]	
97	M66EN	N/A	97	AD[11]	
98	GND	N/A	98	GND	
99	GND	N/A	99	AD[09]	
100	AD[08]	N/A	100	C/BE[0]#	
101	AD[07]	N/A	101	+3.3V	
102	+3.3V	N/A	102	AD[06]	
103	AD[05]	N/A	103	AD[04]	
104	AD[03]	N/A	104	GND	
105	GND	N/A	105	AD[02]	
106	AD[01]	N/A	106	AD[00]	
107	+3.3V	N/A	107	+3.3V	
108	ACK64#	N/A	108	REQ64#	
109	+5V	N/A	109	+5V	
110	+5V	N/A	110	+5V	
111	GND	N/A	111	C/BE[7]#	

Intel® Server Boards S3000AHLX, S3000AH, and S3000AHV TPS

Pin-Side B	PCI Spec Signal	Description	Pin-Side A	PCI Spec Signal	Description	
112	C/BE[6]#	N/A	112	C/BE[5]#		
113	C/BE[4]#	N/A	113	GND		
114	GND	N/A	114	PAR64		
115	AD[63]	N/A	115	AD[62]		
116	AD[61]	N/A	116	3.3V		
117	3.3V	N/A	117	AD[60]		
118	AD[59]	N/A	118	AD[58]		
119	AD[57]	N/A	119	GND		
120	GND	N/A	120	AD[56]		
121	AD[55]	N/A	121	AD[54]		
122	AD[53]	N/A	122	3.3V		
123	GND	N/A	123	AD[52]		
124	AD[51]	N/A	124	AD[50]		
125	AD[49]	N/A	125	GND		
126	3.3V	N/A	126	AD[48]		
127	AD[47]	N/A	127	AD[46]		
128	AD[45]	N/A	128	GND		
129	GND	N/A	129	AD[44]		
130	AD[43]	N/A	130	AD[42]		
131	AD[41]	N/A	131	3.3V		
132	GND	N/A	132	AD[40]		
133	AD[39]	N/A	133	AD[38]		
134	AD[37]	N/A	134	GND		
135	3.3V	N/A	135	AD[36]		
136	AD[35]	N/A	136	AD[34]		
137	AD[33]	N/A	137	GND		
138	GND	N/A	138	AD[32]		
139	Type1	Type(1:0)	139	GND		
		(1U)00 = PCIe*				
		(1U)01 = PCI				
		(1U)10 = N/A				
		(1U)11 = N/A				
140	Type0	(2U)00=2xPCIe* + PCI	140	Size	0=1U, 1=2U	
		(2U)01=3x PCI				
		(2U)10=PXH 3 PCI-X*				
		(2U)11=No Riser				
	Special Riser Signals					

6.3 SMBus Connector

Table 48. SMBus Connector Pin-out (J1E1)

Pin	Signal Name	Description
1	SMB_DAT_5V_BP	Data Line
2	GND	GROUND
3	SMB_CLK_5V_BP	Clock Line
4	TP_BP_I2C_HRD_4	Test Point

6.4 IDE Connector

The board provides one 40-pin ATA-100 IDE connector.

Table 49. ATA 40-pin Connector Pin-out (J3J2)

Pin	Signal Name	Pin	Signal Name
1	RESET#	2	GND
3	IDE_DD7	4	IDE_DD8
5	IDE_DD6	6	IDE_DD9
7	IDE_DD5	8	IDE_DD10
9	IDE_DD4	10	IDE_DD11
11	IDE_DD3	12	IDE_DD12
13	IDE_DD2	14	IDE_DD13
15	IDE_DD1	16	IDE_DD14
17	IDE_DD0	18	IDE_DD15
19	GND	20	KEY
21	IDE_DMAREQ	22	GND
23	IDE_IOW#	24	GND
25	IDE_IOR#	26	GND
27	IDE_IORDY	28	GND
29	IDE_DMAACK#	30	GND
31	IRQ_IDE	32	Test Point
33	IDE_A1	34	DIAG
35	IDE_A0	36	IDE_A2
37	IDE_DCS0#	38	IDE_DCS1#
39	IDE_HD_ACT#	40	GND

6.5 Front Panel Connector

A standard SSI 24-pin header is provided to support a system front panel. The header contains reset, NMI, power control buttons, and LED indicators. The following table details the pin-out of this header.

Table 50. Front Panel 24-Pin Header Pin-out (J1J3)

Signal Name	Pin	Signal Name	Pin
FP_PWR_LED_P1	1	P3V3_STBY	2
KEY	3	P5V_STBY	4
FP_GPIO_GRN_BLNK_HDR	5	FP_ID_LED_N	6
P3V3	7	TP_SSI_PIN8	8
LED_HD_N	9	TP_SSI_PIN10	10
FP_SW_ON_HDR_N	11	FP_NIC1_ACT_LED_R_N	12
GND	13	NIC1_LINK_1_N	14
FP_RST_FPHDR_N	15	TP_SSI_PIN16	16
GND	17	TP_SSI_PIN18	18
FP_ID_BTN_N	19	FP_Intruder_HDR_N	20
TP_FM_ONE_WIRE_TEMP_SENSOR	21	FP_NIC2_ACT_LED_R_N	22
TP_SSI_PIN23	23	NIC2_LINK_UP_N	24

6.6 I/O Connectors

6.6.1 VGA Connector

The following table details the pin-out of the VGA connector. This connector is stacked with the COM1 connector.

Table 51. VGA Connector Pin-out (J8A1)

Signal Name	Pin	Signal Name	Pin
RED	B1	Fused VCC (+5V)	B9
GREEN	B2	GND	B10
BLUE	B3	NC (no connect)	B11
NC	B4	DDCDAT	B12
GND	B5	HSY	B13
GND	B6	VSY	B14
GND	B7	DDCCLK	B15
GND	B8		

6.6.2 NIC Connectors

The server board supports two NIC RJ-45 connectors. The following tables detail the pin-out of the connectors.

Table 52. NIC2-Intel® 82541PI (10/100/1000) Connector Pin-out (JA6A1)

Signal Name	Pin	Signal Name	Pin
P1V8_NIC_RC	1	NIC1_DMI0_DN	10
NIC2_DMI2_DN	2	NIC1_DMI0_DNP	11
NIC2_DMI2_DP	3	P1V8_NIC_RC	12
NIC1_DMI2_DP	4	NIC2_LINK1000_N	13
NIC1_DMI2_DN	5	NIC2_LINK100_N	14
P1V8_NIC_RC	6	NIC2_ACT_LED_N	15
P1V8_NIC_RC	7	NIC2_LINK_UP_N	16
NIC1_DMI3_DP	8	GND	MP1
NIC1_DMI3_DN	9	GND	MP2

Table 53. NIC1- Intel® 82573E (10/100/1000) Connector Pin-out (JA5A1)

Signal Name	Pin	Signal Name	Pin
P2V5_NIC1	9	P3V3_AUX	20
NIC1_MDI0_DP	10	NIC1_LINK_0_N	21
NIC1_MDI0_DN	11	NIC1_LINK_2_N	22
NIC1_MDI1_DP	12	GND	MP1
NIC1_MDI1_DN	13	GND	MP2
NIC1_MDI2_DP	14	GND	MP3
NIC1_MDI2_DN	15	GND	MP4
NIC1_MDI3_DP	16	GND	MP5
NIC1_MDI3_DN	17	GND	MP6
GND	18	GND	MP7
NIC1_LINK_1_N	19	GND	MP8

6.6.3 SATA Connectors

Refer to the following table for the pin-out for the four SATA connectors.

Table 54. SATA Connector Pin-out (J1G2, J1H1, J1J2, J2J1)

Pin	Signal Name
1	GND
2	SATA0_TX_P
3	SATA0_TX_N
4	GND
5	SATA0_RX_N
6	SATA0_RX_P
7	GND

6.6.4 Floppy Controller Connector

The board provides a standard 34-pin interface to the floppy drive controller. The following table details the pin-out of the 34-pin floppy connector.

Table 55. Legacy 34-pin Floppy Connector Pin-out (J2J3)

Signal Name	Pin	Signal Name	Pin
GND	1	FDDENSEL	2
GND	3	Unused	4
KEY	5	FDDRATE0	6
GND	7	FDINDEX#	8
GND	9	FDMTR0#	10
GND	11	FDR1#	12
GND	13	FDR0#	14
GND	15	FDMTR1#	16
Unused	17	FDDIR	18
GND	19	FDSTEP#	20
GND	21	FDWDATA#	22
GND	23	FDWGATE#	24
GND	25	FDTRK0#	26
Unused	27	FLWP#	28
GND	29	FRDATA#	30
GND	31	FHDSEL#	32
GND	33	FDSKCHG#	34

6.6.5 Serial Port Connectors

The server board has one serial port. A standard, external DB-9 serial connector is located on the back edge of the server board to supply a serial interface. This connector is stacked with VGA connector (J8A1)

Table 56. External DB-9 Serial A Port Pin-out (J8A1)

Signal Name	Pin	Signal Name	Pin
DCD-P	T1	DSR-P	T6
RXD-P	T2	RTS-P	T7
TXD-P	T3	CTS-P	T8
DTR-P	T4	RI-P	T9
GND	T5		

6.6.6 Keyboard and Mouse Connector

The server board has two PS/2 ports to support a keyboard and a mouse. The following table details the pin-out of the PS/2 connectors.

Table 57. Keyboard and Mouse PS/2 Connectors Pin-out (J9A1)

PS/2 Connectors	Pin	Signal Name
Keyboard	K1	RKBDATA
	K2	NC
	K3	GND
	K4	P5V_KB_MS
	K5	RKBCLK
	K6	NC
Mouse	M1	MSEDATA
	M2	NC
	M3	GND
	M4	P5V_KB_MS
	M5	RMSCLK
	M6	NC

6.6.7 USB Connector

The following table provides the pin-out for the dual external USB connectors. This connector is stacked with an RJ-45 (connected to NIC1 LAN signals).

Table 58. USB Connectors Pin-out (JA5A1)

Pin	Signal Name
U1	P5V_USB_BP_MJ
U2	USB_BACK5_R_DN
U3	USB_BACK5_R_DP
U4	GND
U5	P5V_USB_BP_MJ
U6	USB_BACK4_R_DN
U7	USB_BACK4_R_DP
U8	GND

A header on the server board provides an option to support two additional USB connectors. The following table shows the details of the pin-out of the header.

Table 59. Optional USB Connection Header Pin-out (J1F2)

Signal Name	Pin	Signal Name	Pin
NC	1	Key	2
GND	3	GND	4
USB_FRONT1_INDUCTOR_DP	5	USB_FRONT2_INDUCTOR_DP	6
USB_FRONT1_INDUCTOR_DN	7	USB_FRONT2_INDUCTOR_DN	8
USB_FNT_PWR	9	USB_FNT_PWR	10

6.7 Fan Headers

The server board supports five general-purpose fan headers. All fan headers are 4-pin fan headers (J7J1, J8D1, J4J1, and J6B1, J6J1) and have the same pin-out.

Table 60. Four-pin Fan Headers Pin-out (J7J1, J8D1, J4J1, and J6B1, J6J1)

Pin	Signal Name	Type	Description
1	Ground	Power	The power supply ground
2	Fan Power	Power	Fan Power pin
3	Fan Tach	Out	The signal works with the Heceta to monitor the fan speed
4	PWM	Control	Pulse Width Modulation – Fan Speed Control signal

6.8 Miscellaneous Headers and Connectors

6.8.1 Back Panel I/O Connectors

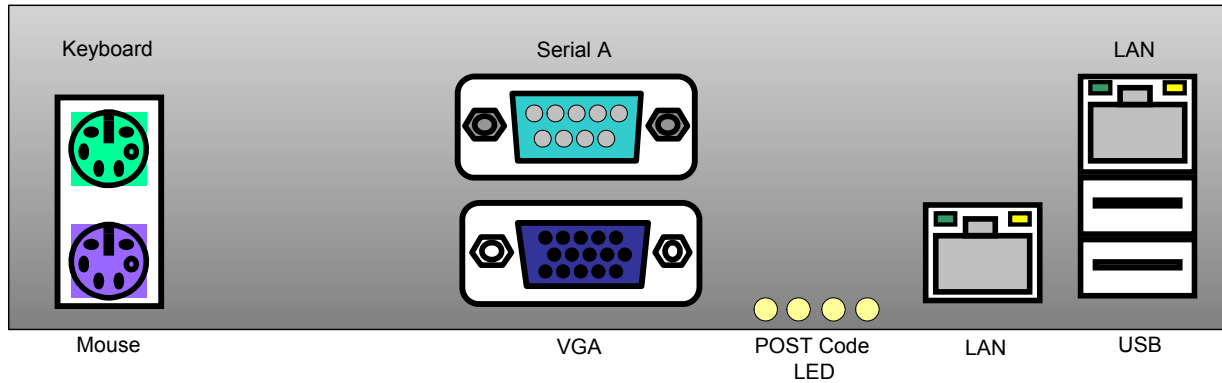

Figure 34. Intel® Server Board S3000AHLX Back Panel I/O connectors

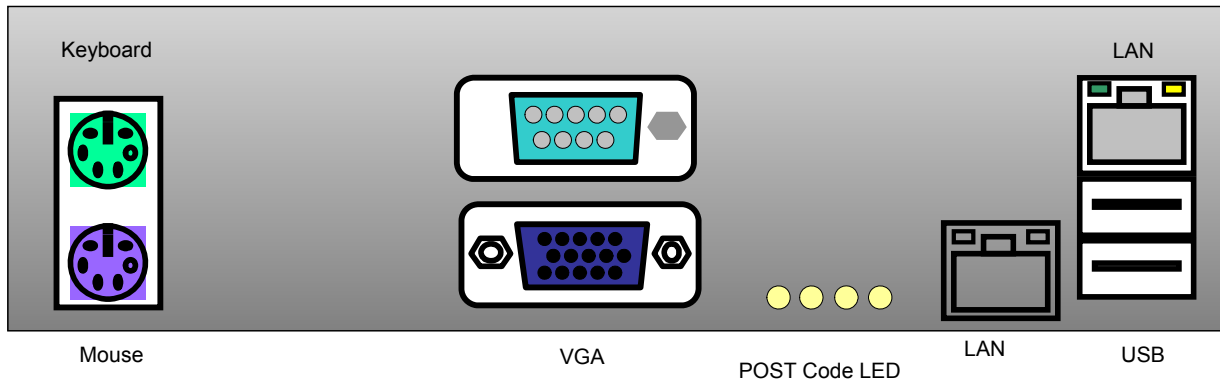

Figure 35. Intel® Server Board S3000AH Back Panel I/O connectors

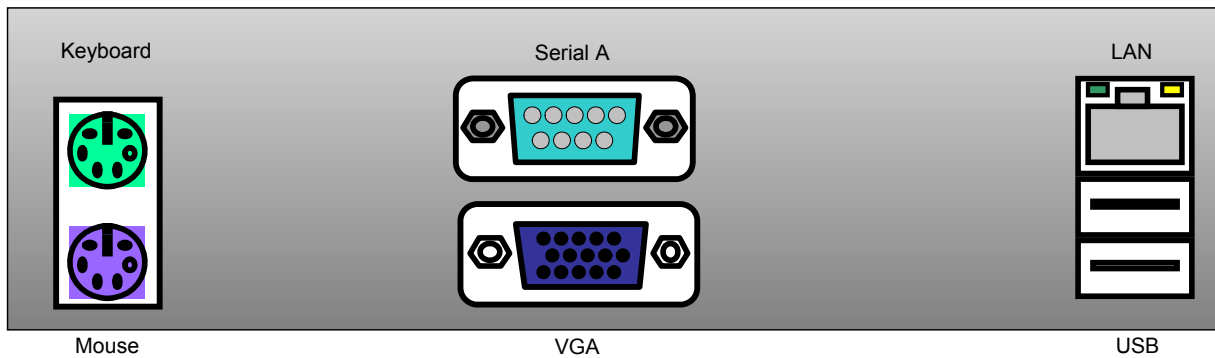

Figure 36. Intel® Server Board S3000AHV Back Panel I/O connectors

6.8.2 Chassis Intrusion Header

A 1x2 pin header (J6J2) is used in chassis that support a chassis intrusion switch. The Intel® ICH7R monitors this header. For more information, see the pin-out definition for the following header.

Table 61. Chassis Intrusion Header (J6J2) Pin-out

Pin	Signal Name
1	FP_INTRUDER_HDR_P1
2	FP_INTRUDER_HDR_N

6.8.3 HDD ACTIVE LED Header

There is a 1x2-pin header for the HDD LED connection. This jumper is reserved for PCI add-in cards that support the SCSI or SATA interface with an external HDD LED activity cable.

Table 62. HDD LED Header (J1H2) Pin-out

Pin	Signal Name
1	FM_SIO_SCSI_ACT_N
2	TP_SCSI_ACT_PIN2

6.9 Jumper Blocks

This section describes the configuration jumper options on the server board.

6.9.1 NIC1 NVM Protect

The server board provides a 3-pin jumper block to perform Intel® 82573E firmware protected and unprotected options. The factory default is set to protected mode. Refer to the following table for the pin-out options.

Table 63. NIC1 NVM Protect Mode (J4A1)

Name	Pin – Pin	Function	Description
Default	1-2	Protected	The default jumper position does not allow the Intel® 82573E firmware to be programmed.
Update	2-3	Unprotected	The update jumper position allows the Intel® 82573E firmware to be programmed.

6.9.2 Clear CMOS and System Maintenance Mode Jumpers

Both the CMOS Clear and the System Maintenance Mode jumpers consist of 3-pin headers (CMOS Clear = J1G3, Maintenance Mode = J1H3) located just beside the front panel and SATA 1 connectors. The server board provides two 3-pin jumper blocks to clear the NVRAM, system BIOS recovery, and system maintenance mode options. The factory defaults are set to normal mode for each function.

The following tables describe each jumper option.

Table 64. System Maintenance Mode (J1H3)

Name	Pin – Pin	Function	Description
Normal	1-2	Normal Operation	Allows normal system operation with correct BIOS settings. System will POST normally.
Maintenance Mode	2-3	Maintenance Mode	Intel® AMT setting/password reset.
Recovery Boot	Off	BIOS Recovery Mode	Used to recover the system when the BIOS is corrupted. Bootable media with a valid BIOS ROM is required.

Table 65. Clear CMOS Jumper Options (J1G3)

Name	Pin – Pin	Function	Description
Normal	1-2	Normal Operation	Jumper in normal position allows system to successfully POST and boot to the operating system environment. BIOS settings remain intact.
CMOS Clear	2-3	Clears CMOS (NVRAM)	Jumper in clear position clears CMOS following POST. A system message confirms the CMOS/NVRAM clear operation was successful. This setting enforces default BIOS settings. Select <F2> to enter setup and change the settings. Exit setup by selecting <F10> and saving changes.

6.9.3 SPI/FWH Selection Header

Table 66. SPI/FWH Selection Header (J1F1)

Name	Pin – Pin	Function	Description
Default	1-2	Select SPI	The jumper should always be connected on the default pins
<u>FWH</u>	2-3	Select FWH	The FWH part is removed In production boards

7. Absolute Maximum Ratings

Operating the server board at conditions beyond those shown in the following table may cause permanent damage to the system. The table provides information for stress testing purposes only. Exposure to absolute maximum rating conditions for extended periods may affect system reliability.

Table 67. Absolute Maximum Ratings

Operating Temperature	5 °C to 50 °C ¹
Storage Temperature	-55 °C to +150 °C
Voltage on any signal with respect to ground	-0.3 V to Vdd (supply voltage for the device) + 0.3V ²
3.3 V Supply Voltage with respect to ground	-0.3 V to 3.63 V
5 V Supply Voltage with respect to ground	-0.3 V to 5.5 V

Note: The Chassis design must provide proper airflow to avoid exceeding the processor maximum case temperature.

7.1 Mean Time Between Failures (MTBF) Test Results

This section provides results of MTBF testing done by a third party testing facility. MTBF is a standard measure for the reliability and performance of the board under extreme working conditions. The MTBF was measured at TBD hours at 35 degrees C.

7.2 Calculated MTBF

The MTBF for the server boards with a default factory configuration is shown in the following table.

Table 68. MTBF Data

Product Code	Calculated MTBF	Operating Temperature
Intel® Server Board S3000AH	282569 Hours	35 degrees Celcius
Intel® Server Board S3000AH	111326 Hours	55 degrees Celcius
Intel® Server Board S3000AHLX	265866 Hours	35 degrees Celcius
Intel® Server Board S3000AHLX	104745 Hours	55 degrees Celcius

8. Design and Environmental Specifications

8.1 Power Budget

The following table shows the power consumed on each supply line for a server board configured with one processor (128 W max). This configuration includes four 1 GB DDR2 DIMMs stack burst at 70% max. The numbers in the following table provides a reference for power budgeting. Different hardware configurations produce different numbers. The numbers in the table reflect a common usage model operating at a higher than average stress level.

Table 69. Power Budget

Watts			Power Supply Rail Voltages						Units
Functional Unit	Utilization	Power	AMPS						
			3.3 V	5 V	12 V	12 V VRM	-12 V	5 VSB	
Baseboard Input Totals		290.73W	6.26 W	8.47W	6.38W	9.28 W	0.05W	1.67	
Baseboard Discrete Totals	50%	32.02W	1.51	1.17	0.00	0.00	0.00	0.00	
Baseboard Converters	Efficiency	41.90W	3.24	7.29	0.00	9.28	0.00	1.67	
Baseboard Config Totals		246.80W	1.52	0.00	6.38	0.00	0.05	0.00	
System Components		49W	0.00	3A	2.8 A	0.00	0.00	0.00	
System Components – SR1530		87W	0.00	2.1 A	6.4 A	0.00	0.00	0.00	
System Totals		335.85W	6.26	10.87	9.14	9.28	0.05	1.67	Amps
System Totals – Intel® Server Chassis SR1530		N/A	N/A	N/A	N/A	N/A	N/A	N/A	
3.3v/5v Combined Power		N/A	N/A	N/A	N/A	N/A	N/A	N/A	
Power Supply Requirements – Intel® Server Chassis SC5295-E		350W	22A	21A	10A + 16A=26A		0.8A	2A	
Power supply Requirements – 350W EPS1U		350W peak	N/A	N/A	N/A		N/A	N/A	
3.3V/5V Combined Power		130W	1Amin	1Amin	2Amin	2Amin	0Amin	1Amin	

8.2 Power Supply Specifications

This section provides power supply design guidelines for the server board including voltage and current specifications, and power supply on/off sequencing characteristics.

Table 70. Server Board Power Supply Voltage Specification

Parameter	Tolerance	Min	Nom	Max	Units
+ 3.3V	- 5% / +5%	+3.14	+3.30	+3.46	Vrms
+ 5V	- 5% / +5%	+4.75	+5.00	+5.25	Vrms
+ 12V	- 5% / +5%	+11.40	+12.00	+12.60	Vrms
- 12V	- 10% / +10%	-11.40	-12.00	-13.08	Vrms
+ 5VSB	- 5% / +5%	+4.75	+5.00	+5.25	Vrms

8.2.1 Power Timing Requirements

These are the timing requirements for the power supply operation. The output voltages must rise from 10% to within regulation limits (Tvout_rise) within 5 to 70ms, except for 5V SB, which can rise from 1.0 to 70 ms. The +3.3 V, +5 V and +12 V output voltages should start to rise approximately at the same time. **All outputs must rise monotonically.** The +5 V output needs to be greater than the +3.3V output during any point of the voltage rise. The +5 V output must never be greater than the +3.3V output by more than 2.25V. Each output voltage should reach regulation within 50ms (Tvout_on) of each other during turn on of the power supply. Each output voltage should fall out of regulation within 400msec (Tvout_off) of each other during turn off. Refer to the following table for the timing requirements to turn the power supply on and off via the AC input, with PSON held low and the PSON signal, and with the AC input applied.

Table 71. Output Voltage Timing

Item	Description	MIN	MAX	UNITS
Tvout_rise	Output voltage rise time from each main output	5.0 *	70 *	msec
Tvout_on	All main output must be within regulation of each other within this time	N/A	50	msec
Tvout_off	All main outputs must leave regulation within this time	N/A	400	msec

The 5VSB output voltage rise time will be from 1.0ms to 25.0ms

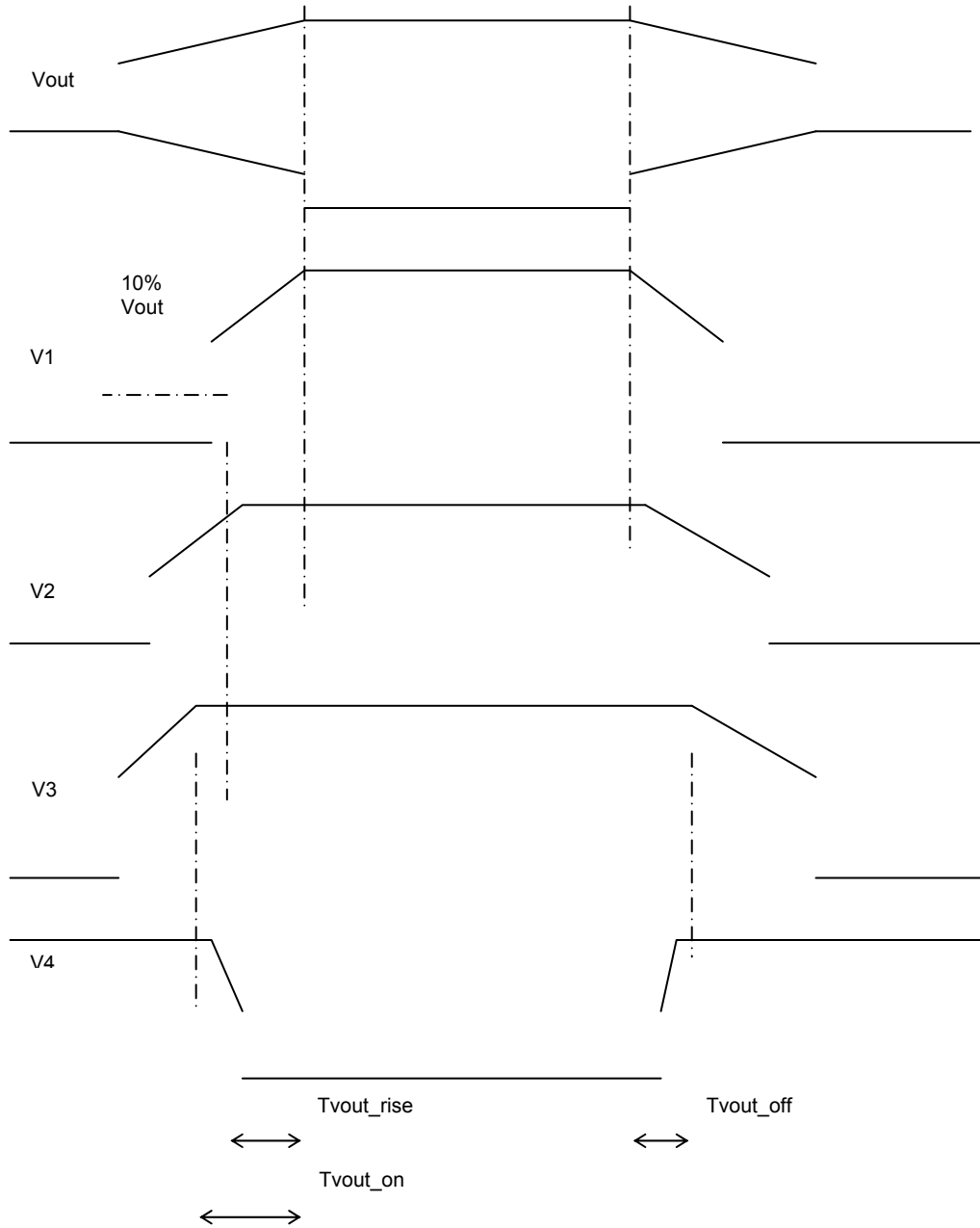

Figure 37. Output Voltage Timing

Table 72. Turn On/Off Timing

Item	Description	Min	Max	Units
Tsb_on_delay	Delay from AC applied to 5VSB within regulation	N/A	1500	msec
T ac_on_delay	Delay from AC applied to all output voltages being within regulation	N/A	2500	msec
Tvout_holdup	Time all output voltages stay within regulation after loss of AC	21		msec
Tpwok_holdup	Delay from loss of AC to de-assertion of PWOK	20		msec
Tpson_on_delay	Delay from PSON# active to output voltages within regulation limits	5	400	msec
T pson_pwok	Delay from PSON# deactivate to PWOK being de-asserted		50	msec
Tpwok_on	Delay from output voltages within regulation limits to PWOK asserted at turn on	100	1000	msec
T pwok_off	Delay from PWOK de-asserted to output voltages (3.3V, 5V, 12V, -12V) dropping out of regulation limits	1	200	msec
Tpwok_low	Duration of PWOK in the de-asserted state during an off/on cycle using AC or the PSON signal	100		msec
Tsb_vout	Delay from 5VSB in regulation to O/Ps in regulation at AC turn on	50	1000	msec
T5VSB_holdup	Time the 5VSB output voltage stays within regulation after loss of AC	70		msec

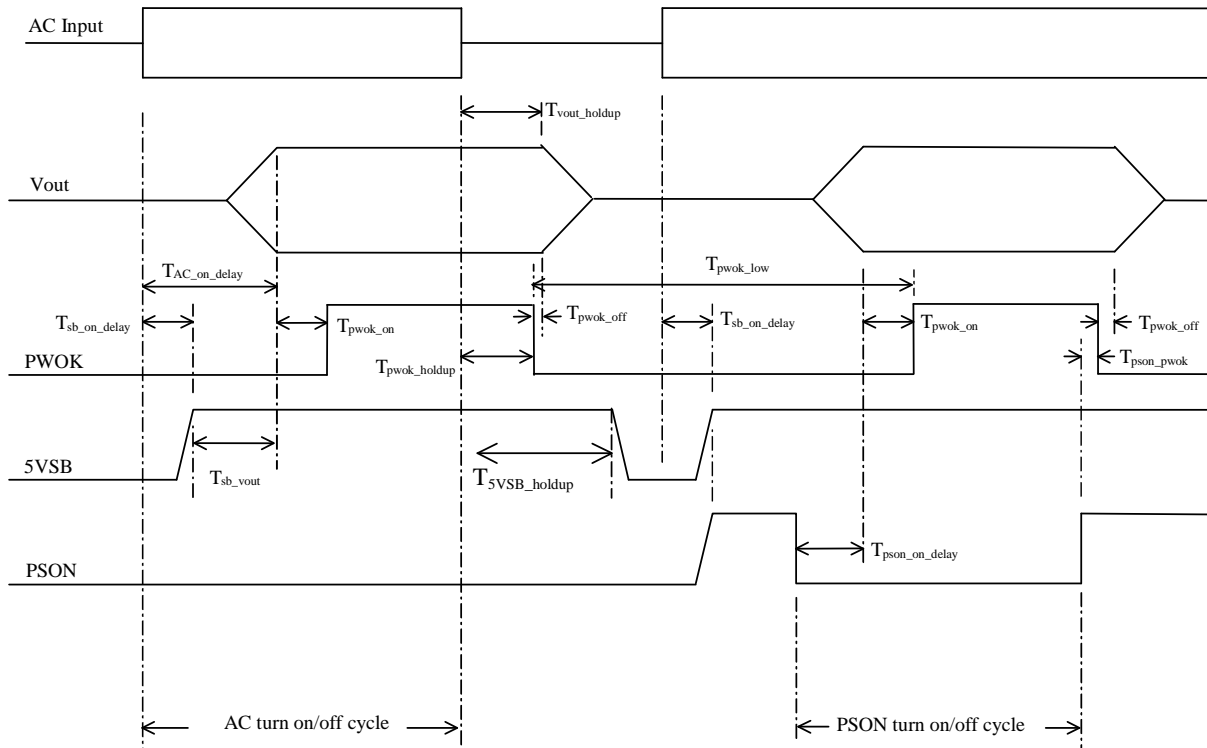

Figure 38. Turn On/Off Timing (Power Supply Signals)

8.2.2 Dynamic Loading

The output voltages should remain within limits specified for the step loading and capacitive loading specified in the following table. The load transient repetition rate is tested between 50 Hz and 5 kHz at duty cycles ranging from 10%-90%. The load transient repetition rate is only a test specification. The Δ step load may occur anywhere within the MIN load to the MAX load conditions.

Table 73. Transient Load Requirements

Output	Δ Step Load Size (See note 2)	Load Slew Rate	Test capacitive Load
+3.3V	5.0A	0.25 A/ μ sec	250 μ F
+5V	6.0A	0.25 A/ μ sec	400 μ F
12V	9.0A	0.25 A/ μ sec	500 μ F
+5VSB	0.5A	0.25 A/ μ sec	20 μ F

Note: Step loads on each 12 V output may happen simultaneously.

Note: For Load Range 2 (light system loading), the tested step load size should be 60% of those listed.

8.2.3 AC Line Transient Specification

AC line transient conditions are defined as “sag” and “surge” conditions. “Sag” conditions are commonly referred to as “brownout”; these conditions are defined as the AC line voltage dropping below nominal voltage conditions. “Surge” refers to conditions when the AC line voltage rises above nominal voltage.

The power supply meets the requirements under AC line sag and surge conditions listed in the following table.

Table 74. AC Line Sag Transient Performance

AC Line Sag				
Duration	Sag	Operating AC Voltage	Line Frequency	Performance Criteria
Continuous	10%	Nominal AC Voltage ranges	50/60Hz	No loss of function or performance
0 to 1 AC cycle	95%	Nominal AC Voltage ranges	50/60Hz	No loss of function or performance
> 1 AC cycle	>30%	Nominal AC Voltage ranges	50/60Hz	Loss of function acceptable, self recoverable

Table 75. AC Line Surge Transient Performance

AC Line Surge				
Duration	Surge	Operating AC Voltage	Line Frequency	Performance Criteria
Continuous	10%	Nominal AC Voltages	50/60Hz	No loss of function or performance
0 to ½ AC cycle	30%	Mid-point of nominal AC Voltages	50/60Hz	No loss of function or performance

8.2.4 AC Line Fast Transient (EFT) Specification

The power supply meets the *EN61000-4-5* directive and any additional requirements in *IEC1000-4-5:1995* and the Level 3 requirements for surge-withstand capability with the following conditions and exceptions:

- These input transients must not cause any out-of-regulation conditions, such as overshoot and undershoot, or cause any nuisance trips for any of the power supply protection circuits.
- The surge-withstand test must not produce damage to the power supply.
- The supply must meet surge-withstand test conditions under maximum and minimum DC-output load conditions.

8.3 Product Regulatory Compliance

This product was evaluated as Information Technology Equipment (ITE), which may be installed in offices, schools, computer rooms, and similar commercial type locations. The suitability of this product for other product categories and environments, other than an ITE application (such as medical, industrial, telecommunications, NEBS, residential, alarm systems, test equipment, and so forth) may require further evaluation. This is an FCC Class A device. Integration into a Class B chassis does not result in a Class B device.

8.3.1 Product Safety Compliance

The server board complies with the following safety requirements:

- UL60950 – CSA 60950(USA / Canada)
- EN60950 (Europe)
- IEC60950 (International)
- CB Certificate and Report, IEC60950 (report to include all country national deviations)
- CE - Low Voltage Directive 73/23/EEE (Europe)

8.3.2 Product EMC Compliance – Class A Compliance

Note: The product is sold commercially and must comply with Class A emission requirements.

- FCC /ICES-003 - Emissions (USA/Canada) Verification
- CISPR 22 – Class A Emissions (International)
- EN55022 – Class A Emissions (Europe)
- EN55024 - Immunity (Europe)
- CE – EMC Directive 89/336/EEC (Europe)
- VCCI, Class A Emissions (Japan)
- AS/NZS 3548 Class A Emissions (Australia / New Zealand)
- BSMI CNS13438 Emissions (Taiwan)
- RRL MIC Notice No. 1997-41 (EMC) and 1997-42 (EMI) (Korea)

8.3.3 Certifications / Registrations / Declarations

- UL Certification (US/Canada)
- CB Certification (International)
- CE Declaration of Conformity (CENELEC Europe)
- FCC/ICES-003 Class A Attestation (USA/Canada)
- C-Tick Declaration of Conformity (Australia)
- MED Declaration of Conformity (New Zealand)
- BSMI Declaration (Taiwan)
- RRL Certification (Korea)

8.3.4 RoHS

Intel restricts the use of banned substances in accordance with the European Directive 2002/95/EC. Compliance requires that RoHS banned materials either are below all applicable substance threshold limits or exempt under an approved/pending RoHS exemption.

Note: RoHS implementation details are not fully defined and may change.







Listed below are the threshold limits and banned substances.

- Quantity limit of 0.1% by mass (1000 PPM) for:
 - Lead
 - Mercury
 - Hexavalent Chromium
 - Polybrominated Biphenyls Diphenyl Ethers (PBDE)
- Quantity limit of 0.01% by mass (100 PPM) for:
 - Cadmium

8.3.5 Product Regulatory Compliance Markings

This product is marked with the following Product Certification Markings:

Table 76. Product Certification Markings

Regulatory Compliance	Region	Marking
UL Mark	USA/Canada	 C US E139761
CE Mark	Europe	
EMC Marking (Class A)	Canada	CANADA ICES-003 CLASS A CANADA NMB-003 CLASSE A
BSMI Marking (Class A)	Taiwan	 D33025 <div style="border: 1px solid black; padding: 5px; margin-top: 5px;"> <p>警告使用者： 這是甲類的資訊產品，在居住的環境中使用時，可能會造成射頻干擾，在這種情況下，使用者會被要求採取某些適當的對策</p> </div>
Ctick Marking	Australia / New Zealand	 N232
RRL MIC Mark	Korea	 인증번호: CPU-S3000AH (A)
Country of Origin	Exporting Requirements	MADE IN xxxxx
PB Free Marking	Environmental Requirements	 2nd lvl intct 

8.4 Electromagnetic Compatibility Notices

8.4.1 FCC (USA)

This device complies with Part 15 of the FCC Rules. Operation is subject to the following two conditions: (1) this device may not cause harmful interference, and (2) this device must accept any interference received, including interference that may cause undesired operation.

For questions related to the EMC performance of this product, contact:

Intel Corporation
5200 N.E. Elam Young Parkway
Hillsboro, OR 97124-6497
1-800-628-8686

This equipment has been tested and found to comply with the limits for a Class A digital device, pursuant to Part 15 of the FCC Rules. These limits provide reasonable protection against harmful interference in a residential installation. This equipment generates, uses, and can radiate radio frequency energy and, if not installed and used in accordance with the instructions, may cause harmful interference to radio communications. However, there is no guarantee that interference will not occur in a particular installation. If this equipment does cause harmful interference to radio or television reception, which can be determined by turning the equipment off and on, the user is encouraged to try to correct the interference by one or more of the following measures:

- Reorient or relocate the receiving antenna.
- Increase the separation between the equipment and the receiver.
- Connect the equipment to an outlet on a circuit other than the one to which the receiver is connected.
- Consult the dealer or an experienced radio/TV technician for help.

Any changes or modifications not expressly approved by the grantee of this device could void the user's authority to operate the equipment. The customer is responsible for ensuring compliance of the modified product.

Only peripherals (computer input/output devices, terminals, printers, etc.) that comply with FCC Class A or B limits may be attached to this computer product. Operation with noncompliant peripherals is likely to result in interference to radio and TV reception.

All cables used to connect to peripherals must be shielded and grounded. Operation with cables, connected to peripherals that are not shielded and grounded may result in interference to radio and TV reception.

8.4.2 ICES-003 (Canada)

Cet appareil numérique respecte les limites bruits radioélectriques applicables aux appareils numériques de Classe B prescrites dans la norme sur le matériel brouilleur: "Appareils Numériques", NMB-003 édictée par le Ministre Canadien des Communications.

English translation of the notice above:

This digital apparatus does not exceed the Class B limits for radio noise emissions from digital apparatus set out in the interference-causing equipment standard entitled "Digital Apparatus," ICES-003 of the Canadian Department of Communications.

8.4.3 Europe (CE Declaration of Conformity)

This product has been tested in accordance too, and complies with the Low Voltage Directive (73/23/EEC) and EMC Directive (89/336/EEC). The product has been marked with the CE Mark to illustrate its compliance.

8.4.4 VCCI (Japan)

この装置は、情報処理装置等電波障害自主規制協議会（VCCI）の基準に基づくクラスB情報技術装置です。この装置は、家庭環境で使用することを目的としていますが、この装置がラジオやテレビジョン受信機に近接して使用されると、受信障害を引き起こすことがあります。
取扱説明書に従って正しい取り扱いをして下さい。

English translation of the notice above:

This is a Class B product based on the standard of the Voluntary Control Council for Interference (VCCI) from Information Technology Equipment. If this is used near a radio or television receiver in a domestic environment, it may cause radio interference. Install and use the equipment according to the instruction manual.

8.4.5 Taiwan Declaration of Conformity (BSMI)

警告使用者：
這是甲類的資訊產品，在居住的環境中使用時，可能會造成射頻干擾，在這種情況下，使用者會被要求採取某些適當的對策

The BSMI Certification Marking and EMC warning is located on the outside rear area of the product.

8.4.6 Korean Compliance (RRL)



1. 기기의 명칭(모델명) :
2. 인증번호 :
3. 인증받은 자의 상호 :
4. 제조년월일 :
5. 제조자/제조국가 :

English translation of the notice above:

Type of Equipment (Model Name): On License and Product

Certification No.: On RRL certificate. Obtain certificate from local Intel representative

Name of Certification Recipient: Intel Corporation

Date of Manufacturer: Refer to date code on product

Manufacturer/Nation: Intel Corporation/Refer to country of origin marked on product

8.4.7 CNCA (CCC-China)

The CCC Certification Marking and EMC warning is located on the outside rear area of the product.

声明

此为 A 级产品，在生活环境中，该产品可能会造成无线电干扰。在这种情况下，可能需要用户对其干扰采取可行的措施。

8.5 Mechanical Specifications

The following figure shows the Intel® Server Board S3000AH mechanical drawing. This drawing will be updated in a future revision of this document.

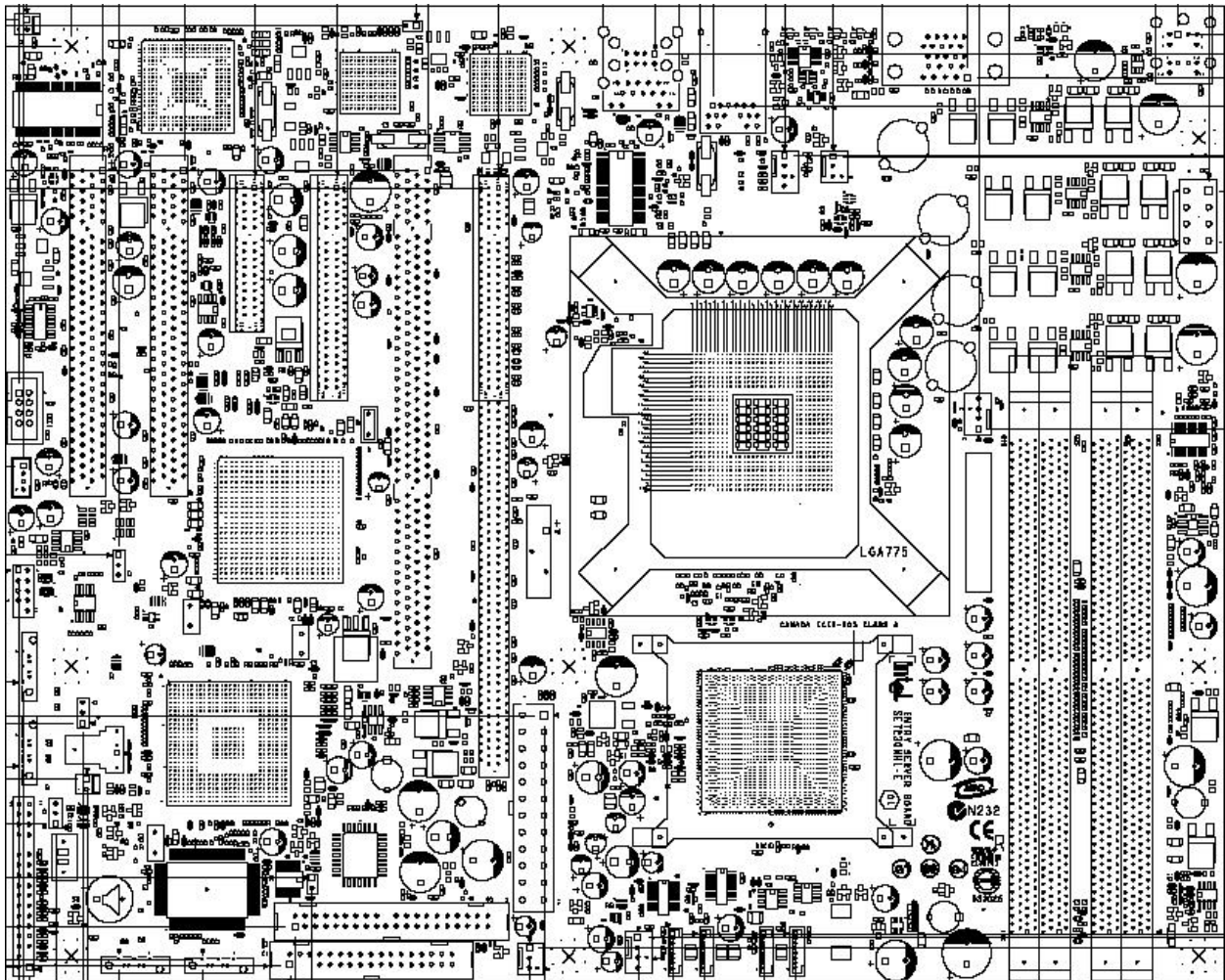

Figure 39. Intel® Server Board S3000AH Mechanical Drawing

The following figures show the I/O shield mechanical drawings for use in pedestal mount applications, such as the Intel® Entry Server Chassis SC5295-E, for the three board SKUs. The Intel® Server Board S3000AH and Intel® Server Board S3000AHLX share the same I/O shield, and Intel® Server Board S3000AHV employs a different I/O shield.

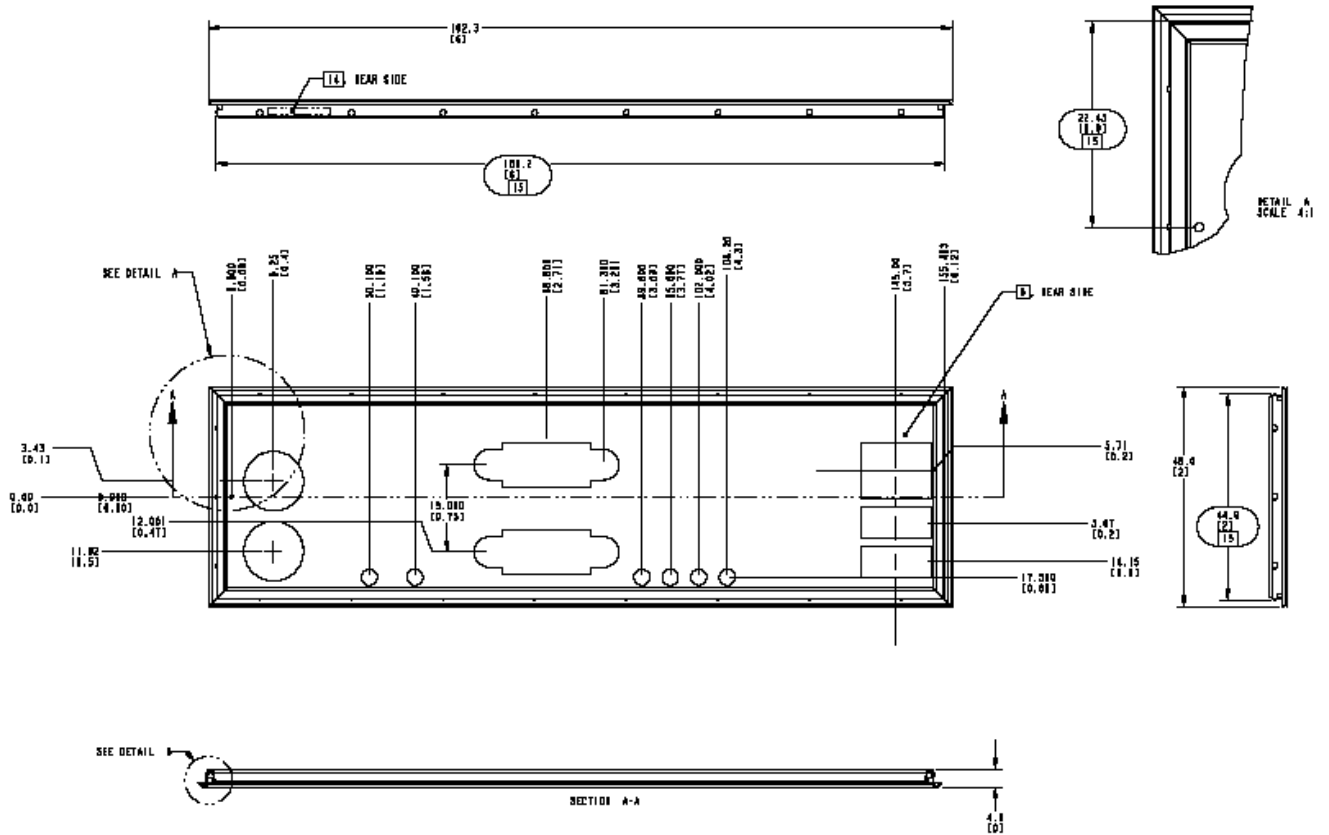

Figure 40. Pedestal Mount I/O Shield Mechanical Drawing for Intel® Server Board S3000AHV

Intel® Server Boards S3000AHLX, S3000AH, and S3000AHV TPS

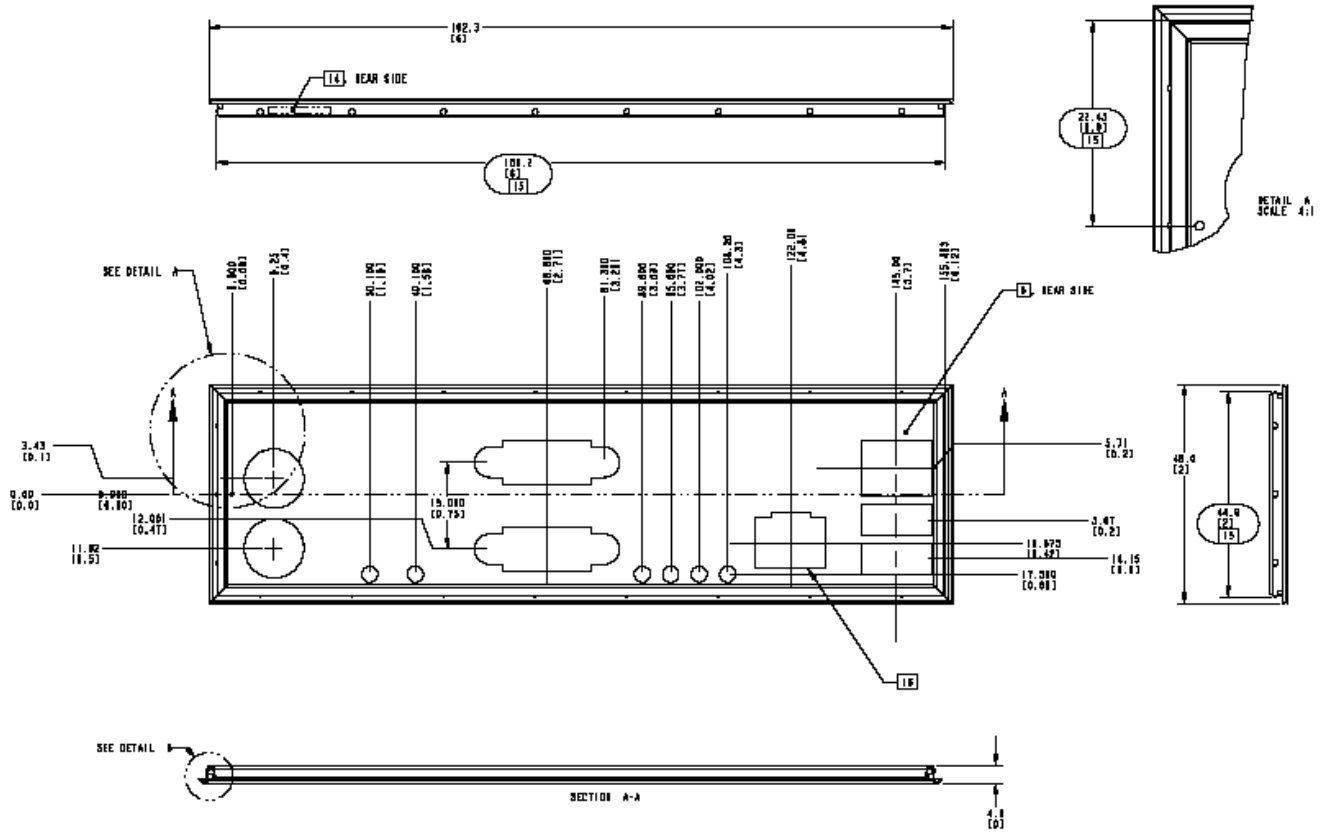

Figure 41. Pedestal Mount I/O Shield Mechanical Drawing for Intel® Server Boards S3000AH and S3000AHLX

9. Hardware Monitoring

9.1 Monitored Components

The server board has implemented hardware monitoring function into the Super I/O SCH5027 chip. The chip provides basic server hardware monitoring which alerts a system administrator if a hardware problem occurs on the board. The [SMSC®](#) SCH5027 chip has implemented some FAN speed control/monitor pins. Below is a table of monitored headers and sensors on the server board.

Table 77. Monitored Components

	Item	Description	
Voltage	VCCP (PIN #127)	Monitors processor voltage	Super I/O
	P12V (PIN #1)	Monitors +12Vin for system +12V supply	Super I/O
	P1V5 (PIN #128)	Monitors chipset 1.5V core voltage for MCH/ICH/PXH	Super I/O
	P5V (PIN #2)	Monitors +5V	Super I/O
Fan Speed	PWM1 (PIN #111)	Controls SYS FAN2 (J7J1)	Super I/O
	PWM2 (PIN #110)	Controls SYS FAN4 and SYS FAN3 (J6B1 and J4J1)	Super I/O
	PWM3 (PIN #109)	Controls CPU FAN and SYS FAN1 (J8D1 and J6J1)	Super I/O
	TACH1 (PIN #115)	Monitors CPU FAN (J8D1)	Super I/O
	TACH2 (PIN #114)	Monitors SYS FAN2 (J7J1)	Super I/O
	TACH3 (PIN #113)	Monitors SYS FAN1 (J6J1)	Super I/O
	TACH4 (PIN #112)	Monitors SYS FAN3 (J4J1)	Super I/O
	TACHA (PIN #79)	Monitors SYS FAN4 (J6B1)	Super I/O
Temperature	CPU_THEMP_DA/C (PIN# 125/126)	Monitors processor temperature	Super I/O
	SE_ZONE_DN/DP (PIN# 123/124)	Monitors DIMM voltage	Super I/O

9.1.1 Fan Speed Control

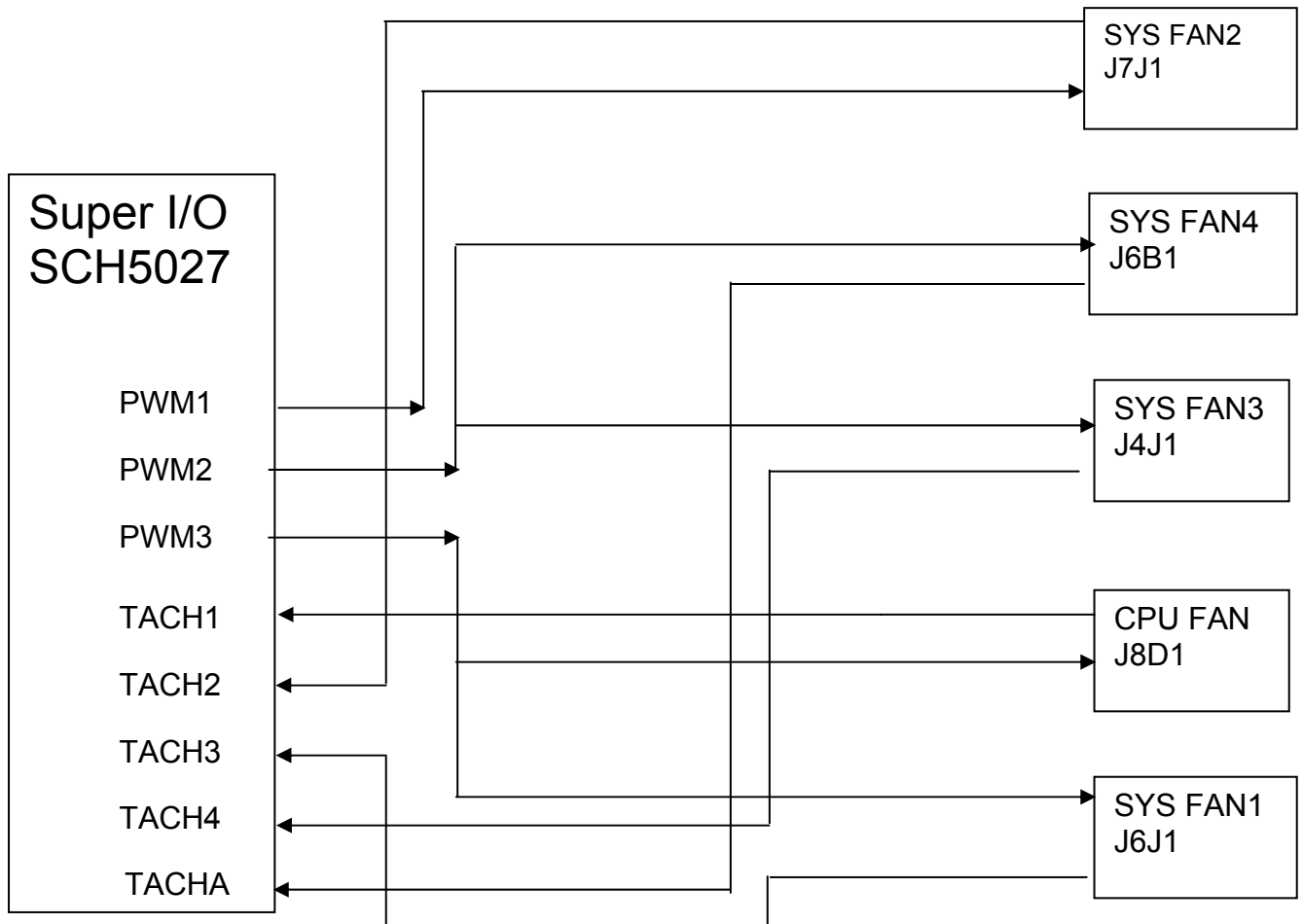

Figure 42. Fan Speed Control Block Diagram

9.2 Chassis Intrusion

The server board supports a chassis security feature that detects the removal of the chassis cover. The chassis power supply must be connected to AC power for the chassis intrusion circuit to function. The security feature uses a mechanical switch on the chassis that attaches to the chassis intrusion connector. When the chassis cover is removed, the mechanical switch is in the open position.

Glossary

This appendix contains important terms used in the preceding chapters. For ease of use, numeric entries are listed first (for example, “82460GX”) with alpha entries following (for example, “AGP 4x”). Acronyms are then entered in their respective place, with non-acronyms following.

Term	Definition
ACPI	Advanced Configuration and Power Interface
ANSI	American National Standards Institute
AP	Application Processor
ASIC	Application Specific Integrated Circuit
ASR	Asynchronous Reset
BGA	Ball-grid Array
BIOS	Basic input/output system
Byte	8-bit quantity
CMOS	In terms of this specification, this describes the PC-AT compatible region of battery-backed 128 bytes of memory, which normally resides on the server board
DCD	Data Carrier Detect
DMA	Direct Memory Access
DMTF	Distributed Management Task Force
ECC	Error Correcting Code
EMC	Electromagnetic Compatibility
EPS	External Product Specification
ESCD	Extended System Configuration Data
FDC	Floppy Disk Controller
FIFO	First-In, First-Out
FRU	Field replaceable unit
GB	1024 MB
GPIO	General purpose I/O
GUID	Globally Unique ID
Hz	Hertz (1 cycle/second)
HDG	Hardware Design Guide
I ² C	Inter-integrated circuit bus
IA	Intel® architecture
ICMB	Intelligent Chassis Management Bus
IERR	Internal error
IMB	Inter Module Bus
IP	Internet Protocol
IRQ	Interrupt Request
ITP	In-target probe
KB	1024 bytes
KCS	Keyboard Controller Style
LAN	Local area network
LBA	Logical Block Address
LCD	Liquid crystal display

Term	Definition
LPC	Low pin count
LSB	Least Significant Bit
MB	1024 KB
MBE	Multi-Bit Error
Ms	milliseconds
MSB	Most Significant Bit
MTBF	Mean Time Between Failures
Mux	Multiplexor
NIC	Network Interface Card
NMI	Non-maskable Interrupt
OEM	Original equipment manufacturer
Ohm	Unit of electrical resistance
PBGA	Pin Ball Grid Array
PERR	Parity Error
PIO	Programmable I/O
PMB	Private Management Bus
PMC	Platform Management Controller
PME	Power Management Event
PnP	Plug and Play
POST	Power-on Self Test
PWM	Pulse-Width Modulator
RAIDIOS	RAID I/O Steering
RAM	Random Access Memory
RI	Ring Indicate
RISC	Reduced instruction set computing
RMCP	Remote Management Control Protocol
ROM	Read Only Memory
RTC	Real Time Clock
SBE	Single-Bit Error
SCI	System Configuration Interrupt
SDR	Sensor Data Record
SDRAM	Synchronous Dynamic RAM
SEL	System event log
SERIRQ	Serialized Interrupt Requests
SERR	System Error
SM	Server Management
SMI	Server management interrupt (the highest priority non-maskable interrupt)
SMM	System Management Mode
SMS	System Management Software
SNMP	Simple Network Management Protocol
SPD	Serial Presence Detect
SSI	Server Standards Infrastructure
TPS	Technical Product Specification
UART	Universal asynchronous receiver and transmitter

Term	Definition
USB	Universal Serial Bus
VGA	Video Graphic Adapter
VID	Voltage Identification
VRM	Voltage Regulator Module
Word	16-bit quantity
ZCR	Zero Channel RAID

Reference Documents

Refer to the following documents for additional information:

- Intel® 3000 Series Chipsets Server Board Family Datasheet
- Intel® Server Board S3000AH/S3000AHLX Tested Hardware and OS List
- Intel® Server Board S3000AH/S3000AHLX / Intel® Server System SR1530AH/SR1530AHLX Spares/Parts List and Configuration Guide
- Intel® Server Board S3000AH/S3000AHLX Tested memory list
- Intel® Server Board S3000AH/S3000AHLX Server hard driver validation test report