

Intel® Server Boards S3200SH/S3210SH

Technical Product Specification

Intel Order Number: E14960-009

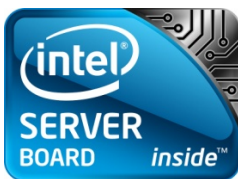

Revision 1.8

May, 2010

Enterprise Platforms and Services Division

Revision History

Date	Revision Number	Modifications
Sept. 2007	1.0	Initial release.
Oct. 2007	1.1	Added new updates.
Jan. 2008	1.2	Corrected some document errors.
Apr. 2008	1.3	Added Intel® Embedded Server RAID Technology.
July 2008	1.4	Added CMOS Clear instructions
Sept. 2008	1.5	Updated Diagnostic LEDs graphic
Jan. 2009	1.6	Grammatical corrections.
Feb. 2009	1.7	Grammatical corrections and minor updates.
May 2010	1.8	Removed CCC.

Disclaimers

Information in this document is provided in connection with Intel® products. No license, express or implied, by estoppel or otherwise, to any intellectual property rights is granted by this document. Except as provided in Intel's Terms and Conditions of Sale for such products, Intel assumes no liability whatsoever, and Intel disclaims any express or implied warranty, relating to sale and/or use of Intel products including liability or warranties relating to fitness for a particular purpose, merchantability, or infringement of any patent, copyright or other intellectual property right. Intel products are not intended for use in medical, life saving, or life sustaining applications. Intel may make changes to specifications and product descriptions at any time, without notice.

Designers must not rely on the absence or characteristics of any features or instructions marked "reserved" or "undefined." Intel reserves these for future definition and shall have no responsibility whatsoever for conflicts or incompatibilities arising from future changes to them.

This document contains information on products in the design phase of development. Do not finalize a design with this information. Revised information will be published when the product is available. Verify with your local sales office that you have the latest datasheet before finalizing a design.

The Intel Server boards Snow Hill family may contain design defects or errors known as errata which may cause the product to deviate from published specifications. Current characterized errata are available on request.

This document and the software described in it is furnished under license and may only be used or copied in accordance with the terms of the license. The information in this manual is furnished for informational use only, is subject to change without notice, and should not be construed as a commitment by Intel Corporation. Intel Corporation assumes no responsibility or liability for any errors or inaccuracies that may appear in this document or any software that may be provided in association with this document.

Except as permitted by such license, no part of this document may be reproduced, stored in a retrieval system, or transmitted in any form or by any means without the express written consent of Intel Corporation.

Intel, Pentium, Itanium, and Xeon are trademarks or registered trademarks of Intel Corporation.

*Other brands and names may be claimed as the property of others.

Copyright © Intel Corporation 2007-2010.

Table of Contents

1. Introduction	1
1.1 Chapter Outline.....	1
1.2 Server Board Use Disclaimer	1
2. Server Board Overview.....	2
2.1 Server Board Feature Set.....	2
2.2 Server Board Layout.....	10
2.2.1 Server Board Mechanical Drawings	11
3. Functional Architecture	13
3.1 Processor Sub-System	15
3.1.1 Processor Voltage Regulator Down (VRD).....	15
3.1.2 Reset Configuration Logic	15
3.2 Intel® 3200/3210 Chipset	16
3.2.1 Intel® 3200/3210 Chipset MCH: Memory Control Hub.....	16
3.2.2 PCI-X Hub (LX board SKU only).....	19
3.2.3 Intel® ICH9R: I/O Controller Hub 9R.....	20
3.3 Memory Sub-System	26
3.3.1 Memory Configuration	26
3.3.2 Memory DIMM Support.....	28
3.4 I/O Sub-System	28
3.4.1 PCI Subsystem	28
3.4.2 Interrupt Routing	30
3.5 BMC Controller	36
3.6 PCI Express* to PCI-X Bridge 6702PXH (PXH-V) (LX Board SKU Only).....	38
3.7 Clock Generator.....	38
3.8 Super I/O	38
3.9 GigE Controller 82541PI.....	39
3.10 GigE PHY	39
3.11 On-Board Components.....	39
3.11.1 Video Support.....	39
3.12 Replacing the Back-Up Battery.....	42
4. System BIOS.....	43
4.1 BIOS Identification String.....	43
4.2 Logo / Diagnostic Window	44

4.3	BIOS Setup Utility	44
4.3.1	Operation	44
4.3.2	Server Platform Setup Screens	47
4.4	Loading BIOS Defaults	75
4.5	Multiple Boot Blocks	75
4.6	Recovery Mode.....	75
4.7	Intel® Matrix Storage Manager.....	76
4.8	Intel® Embedded Server RAID Technology II Support.....	76
5.	Error Reporting and Handling	77
5.1	Error Handling and Logging.....	77
5.1.1	Error Sources and Types.....	77
5.1.2	Error Logging via SMI Handler	78
5.1.3	SMBIOS Type 15.....	78
5.1.4	Logging Format Conventions.....	78
5.2	Error Messages and Error Codes	80
5.2.1	Diagnostic LEDs	80
5.2.2	POST Code Checkpoints.....	81
5.2.3	POST Error Messages and Handling	84
5.2.4	POST Error Beep Codes	85
5.2.5	POST Error Pause Option	85
6.	Connectors and Jumper Blocks	86
6.1	Power Connectors	86
6.1.1	Main Power Connector	86
6.2	Intel® Riser Card for L SKU.....	87
6.3	SMBus Connector.....	87
6.4	Front Panel Connector.....	87
6.5	I/O Connectors.....	88
6.5.1	VGA Connector.....	88
6.5.2	NIC Connectors	88
6.5.3	SATA Connectors	89
6.5.4	Floppy Controller Connector.....	89
6.5.5	Serial Port Connectors.....	90
6.5.6	Keyboard and Mouse Connector	91
6.5.7	USB Connector.....	91
6.6	Fan Headers	92

6.7	Miscellaneous Headers and Connectors	92
6.7.1	Back Panel I/O Connectors	92
6.7.2	Chassis Intrusion Header	93
6.7.3	HDD Active LED Header	93
6.7.4	IPMB	93
6.7.5	HSBP	93
6.7.6	SATA SGPIO	94
6.8	Jumper Blocks	94
6.8.1	CMOS Clear and Password Reset Usage Procedure	94
6.8.2	BMC Force Update Procedure	95
7.	Absolute Maximum Ratings	96
7.1	Mean Time Between Failures (MTBF) Test Results	96
7.2	Calculated Mean Time Between Failures (MTBF)	96
8.	Design and Environmental Specifications.....	97
8.1	Power Budget	97
8.2	Power Supply Specifications	98
8.2.1	Power Timing Requirements	98
8.2.2	Dynamic Loading	101
8.2.3	AC Line Transient Specification.....	101
8.2.4	AC Line Fast Transient (EFT) Specification	102
8.3	Product Regulatory Compliance	102
8.3.1	Product Safety Compliance	102
8.3.2	Product EMC Compliance – Class A Compliance	103
8.3.3	Certifications / Registrations / Declarations	103
8.3.4	Product Regulatory Compliance Markings	105
8.4	Electromagnetic Compatibility Notices	106
8.4.1	FCC (USA).....	106
8.4.2	ICES-003 (Canada)	107
8.4.3	Europe (CE Declaration of Conformity)	107
8.4.4	VCCI (Japan).....	107
8.4.5	Taiwan Declaration of Conformity (BSMI).....	107
8.4.6	Korean Compliance (RRL).....	108
8.5	Mechanical Specifications	109
9.	Hardware Monitoring	112
9.1	Chassis Intrusion	112

Glossary 113

Reference Documents..... 116

List of Figures

Figure 1. Intel® Server Board S3210SHLX Diagram.....	7
Figure 2. Intel® Server Board S3210SHLC Diagram.....	8
Figure 3. Intel® Server Board S3200SH-L/S3200SH-V SKU Diagram.....	9
Figure 4. Intel® Server Board S3210SHLC	10
Figure 5. Intel® Server Board S3210SHLX – Hole and Component Positions.....	11
Figure 6. Intel® Server Boards S3210SHLC/S3200SHL/S3200SHV – Hole and Component Positions.....	12
Figure 7. Intel® Server Boards S3200SH/S3210SH LC/L/V SKU–Block Diagram.....	13
Figure 8. Intel® Server Systems S3200SH/S3210SH LX SKU–Block Diagram	14
Figure 9. Memory Bank Label Definition.....	27
Figure 10. Interrupt Routing Diagram	33
Figure 11. Intel® ICH9R Interrupt Routing Diagram	34
Figure 12. PXH-V Interrupt Routing Diagram	35
Figure 13. Setup Utility — Main Screen Display	48
Figure 14. Setup Utility — Advanced Screen Display.....	50
Figure 15. Setup Utility — Processor Configuration Screen Display	51
Figure 16. Setup Utility — Memory Configuration Screen Display.....	53
Figure 17. Setup Utility — ATA Controller Configuration Screen Display.....	55
Figure 18. Setup Utility — Serial Port Configuration Screen Display.....	57
Figure 19. Setup Utility — USB Controller Configuration Screen Display	58
Figure 20. Setup Utility — PCI Configuration Screen Display	60
Figure 21. Setup Utility — Security Configuration Screen Display	61
Figure 22. Setup Utility — Server Management Configuration Screen Display.....	62
Figure 23. Setup Utility — Console Redirection Screen Display	64
Figure 24. Setup Utility — Server Management System Information Screen Display	65
Figure 25. Setup Utility — Boot Options Screen Display.....	66
Figure 26. Setup Utility — Hard Disk Order Screen Display.....	67
Figure 27. Setup Utility — CDROM Order Screen Display	69
Figure 28. Setup Utility — Floppy Order Screen Display.....	69
Figure 29. Setup Utility — Network Device Order Screen Display.....	70
Figure 30. Setup Utility — BEV Device Order Screen Display.....	71
Figure 31. Setup Utility — Boot Manager Screen Display	72
Figure 32. Setup Utility — Error Manager Screen Display.....	72

Figure 33. Setup Utility — Exit Screen Display	73
Figure 34. Example of Diagnostic LEDs on Server Board	81
Figure 35. Intel® Server Board S3210SHLX / S3210SHLC / S3200SHL Back Panel I/O Connectors	92
Figure 36. Intel® Server Board S3200SHV Back Panel I/O Connectors	93
Figure 37. Output Voltage Timing	99
Figure 38. Turn On/Off Timing (Power Supply Signals).....	100
Figure 39. Intel® Server Board S3200SH Mechanical Drawing	109
Figure 40. Pedestal Mount I/O Shield Mechanical Drawing for the Intel® Server Board S3200SH- V	110
Figure 41. Pedestal Mount I/O Shield Mechanical Drawing for Intel® Server Boards S3200SH- L/S3210SH-LX	111

List of Tables

Table 1. Intel® Server Board S3210SHLX Board SKU Layout Reference	7
Table 2. Intel® Server Board S3210SHLC Layout Reference	8
Table 3. Processor Support Matrix	16
Table 4. Segment F Connections	17
Table 5. Supported DDR2 Modules	18
Table 6. Segment E Configuration IDs	19
Table 7. Segment D Arbitration Connections.....	19
Table 8. Boot BIOS Destination Selection	23
Table 9. SPI Required Command Codes.....	23
Table 10. Memory Bank Labels and DIMM Population Order.....	27
Table 11. Characteristics of Dual/Single Channel Configuration with or without Dynamic Mode	28
Table 12. PCI Bus Segment Characteristics.....	29
Table 13. Segment A Configuration IDs	29
Table 14. Segment A Arbitration Connections.....	30
Table 15. PCI AND PCI-X Interrupt Routing/Sharing.....	30
Table 16. Interrupt Definitions.....	31
Table 17. Video Modes	41
Table 18. BIOS Setup Page Layout.....	45
Table 19. BIOS Setup: Keyboard Command Bar.....	46
Table 20. Setup Utility — Main Screen Fields	49
Table 21. Setup Utility — Advanced Screen Display Fields	51
Table 22. Setup Utility — Processor Configuration Screen Fields.....	52
Table 23. Setup Utility — Memory Configuration Screen Fields.....	53
Table 24. Setup Utility — ATA Controller Configuration Screen Fields	56
Table 25. Setup Utility — Serial Ports Configuration Screen Fields	57
Table 26. Setup Utility — USB Controller Configuration Screen Fields.....	59
Table 27. Setup Utility — PCI Configuration Screen Fields.....	60
Table 28. Setup Utility — Security Configuration Screen Fields.....	61
Table 29. Setup Utility — Server Management Configuration Screen Fields	62
Table 30. Setup Utility — Console Redirection Configuration Fields.....	64
Table 31. Setup Utility — Server Management System Information Fields	65
Table 32. Setup Utility — Boot Options Screen Fields	67
Table 33. Setup Utility — Hard Disk Order Fields.....	68

Table 34. Setup Utility — CDROM Order Fields	69
Table 35. Setup Utility — Floppy Order Fields.....	70
Table 36. Setup Utility — Network Device Order Fields	70
Table 37. Setup Utility — BEV Device Order Fields	71
Table 38. Setup Utility — Boot Manager Screen Fields.....	72
Table 39. Setup Utility — Error Manager Screen Fields	73
Table 40. Setup Utility — Exit Screen Fields	73
Table 41. Event List	77
Table 42. SMBIOS Type 15 Event Log record format.....	79
Table 43. Event Type Definition Table	79
Table 44. POST Progress Code LED Example	81
Table 45. POST Code Checkpoints.....	81
Table 46. POST Error Messages and Handling.....	84
Table 47. POST Error Beep Codes	85
Table 48. Power Connector Pin-out (J4G1).....	86
Table 49. Auxiliary CPU Power Connector Pin-out (J9B2)	86
Table 50. SMBus Connector Pin-out (J1E1).....	87
Table 51. Front Panel 24-Pin Header Pin-out (J1K2)	87
Table 52. VGA Connector Pin-out (J8B1).....	88
Table 53. NIC2-Intel® 82541PI (10/100/1000) Connector Pin-out (J5B1).....	88
Table 54. NIC1- Intel® 82566E (10/100/1000) Connector Pin-out (J6B1).....	89
Table 55. SATA Connector Pin-out (J2K1, J1K1, J1J3, J1H3, J1H2, J1H1).....	89
Table 56. Legacy 34-pin Floppy Connector Pin-out (J3K1).....	89
Table 57. External DB9 Serial A Port Pin-out (J8B1).....	90
Table 58. Keyboard and Mouse PS/2 Connectors Pin-out (J9A1).....	91
Table 59. USB Connectors Pin-out (J5B1)	91
Table 60. Optional USB Connection Header Pin-out (J1G1).....	92
Table 61. Four-pin Fan Headers Pin-out (J4D1, J1K2, J7K1, and J4K1J6B2).....	92
Table 62. Chassis Intrusion Header (J1B2) Pin-out.....	93
Table 63. HDD LED Header (J1J1) Pin-out.....	93
Table 64. Absolute Maximum Ratings	96
Table 65. MTBF Data.....	96
Table 66. Power Budget	97
Table 67. Server Board Power Supply Voltage Specification	98
Table 68. Output Voltage Timing	98

Table 69. Turn On/Off Timing 100

Table 70. Transient Load Requirements..... 101

Table 71. AC Line Sag Transient Performance 101

Table 72. AC Line Surge Transient Performance 102

Table 73. Product Certification Markings 105

< This page intentionally left blank. >

1. Introduction

This Technical Product Specification (TPS) provides a high-level technical description for the Intel® Server Boards S3200SH/S3210SH. It details the architecture and feature set for all functional sub-systems that make up the server boards.

Note: The document uses the term “server board” throughout and it applies to all four board SKUs. When exceptions occur, the document calls out the specific board by name.

1.1 Chapter Outline

This document contains the following chapters:

- Chapter 1 – Introduction
- Chapter 2 – Server Board Overview
- Chapter 3 – Functional Architecture
- Chapter 4 – System BIOS
- Chapter 5 – Error Reporting and Handling
- Chapter 6 – Connectors and Jumper Blocks
- Chapter 7 – Absolute Maximum Ratings
- Chapter 8 – Design and Environmental Specifications
- Chapter 9 – Hardware Monitoring
- Glossary
- Reference Documents

1.2 Server Board Use Disclaimer

Intel Corporation server boards support add-in peripherals and contain a number of high-density VLSI and power delivery components that need adequate airflow to cool. Intel ensures through its own chassis development and testing that when Intel server building blocks are used together, the fully integrated system will meet the intended thermal requirements of these components. It is the responsibility of the system integrator who chooses not to use Intel developed server building blocks to consult vendor datasheets and operating parameters to determine the amount of airflow required for their specific application and environmental conditions. Intel Corporation cannot be held responsible if components fail or the server board does not operate correctly when used outside any of the published operating or non-operating limits.

2. Server Board Overview

The Intel® Server Boards S3210SHLX, S3200SHL, S3200SHV, and S3210SHLC are monolithic printed circuit boards (PCBs) with features designed to support the entry server market.

2.1 Server Board Feature Set

- All board SKUs are based on the Intel® 3200/3210 Chipset
- Supports processors in LGA775 package
- 800/1066/1333 MHz Front Side Bus (FSB) speed
- Four DDR2 667/800MHz unbuffered DIMM memory sockets with or without ECC
- Supports the Intel® ICH9R I/O Controller, interfaced with MCH via DMI
- LX board SKU supports the following I/O slots:
 - One PCI Express* x16 connector to be used as a x16 link from chipset (If a VGA adapter is inserted into this slot, the VGA card will only work at PCI Express* x1 speed; this is a chipset limitation.)
 - One PCI Express* x8 connector to be used as a PCI Express* x8 link from the chipset
 - Two PCI-X 133 MHz, 64-bit connectors
 - One PCI 5 V, 32-bit, 33 MHz connector
- LC board SKU supports following I/O slots:
 - One PCI Express* x16 connector to be used as a x16 link from chipset (If a VGA adapter is inserted into this slot, the VGA card only works at PCI Express* x1 speed; this is a chipset limitation.)
 - One PCI Express* x8 connector to be used as a PCI Express* x8 link from the chipset
 - One PCI Express* x8 connector routed to PCI Express* x4 bus from the ICH9R
 - Two PCI 5 V, 32-bit, 33 MHz connectors
- L and V board SKUs support the following I/O slots:
 - One PCI Express* x16 connector to be used as a x8 link from chipset (If a VGA adapter is inserted into this slot, the VGA card only works at PCI Express* x1 speed; this is a chipset limitation.)
 - One PCI Express* x8 connector routed to the PCI Express* x4 bus from the ICH9R
 - Two PCI 5 V, 32-bit, 33 MHz connectors
- On-board ServerEngines* LLC Pilot II controller (Integrated BMC) supports the following functions:
 - Integrated 2-D video controller on PCI Express* x1
 - Super I/O on LPC
 - Baseboard Management Controller (BMC) based on ARM946E-S

- Winbond* PC8374L super I/O chip interfaced to the Intel® ICH9R through LPC supports the following:
 - PS/2 keyboard/mouse
 - Floppy disk drive (FDD)
 - Six SATA II connectors
- Five USB 2.0 ports: two ports on USB/LAN combo connectors at the rear of the server board, two ports via on-board headers, and one port on an internal vertical connector
- Two Gigabit (Gbit) Ethernet devices interfaced to the Intel® ICH9R to support two rear panel RJ-45 connectors with integrated magnetics; one is through PCI Express* x1, the other one is through PCI32
- ACPI (Advanced Configuration and Power Interface) power management
- System monitoring (temperature, voltage, and fans)
- VRD11 for processor

The server board supports the following feature set:

- Processor and FSB support
 - Supports Intel® Xeon® processor 3000 series, Intel® Xeon® processor 3100 series, Intel® Xeon® processor 3200 series, and Intel® Xeon® processor 3300 series.
 - Supports Intel® dual-core technology
 - Supports Intel® Extended Memory System 64 Technology (Intel® EM64T)
- Intel® 3200/3210 Chipset components
 - Intel® 3200/3210 Memory Controller Hub (MCH)
 - Intel® ICH9R I/O Controller
 - Intel® 6702 PXH-V PCI-X Hub (LX board SKU only)
- Memory System
 - Four DIMM sockets supporting DDR2 667/800MHz DIMMs
 - Data bandwidth per channel of 4.2 GB/s or 8.4 GB/s in dual channel when using DDR2 667 MHz
 - Support for up to two DDR2 channels for a total of four DIMMs (two DIMMs / channel) providing up to 8 GB max memory capacity
 - Support for 512 MB, 1 GB, and 2 GB DRAM modules

Notes: 1. The server board does not support DDR2-533 DIMMs.

2. The server board does not support 256 MB DIMMs.

- I/O Subsystem
- Clock
 - CK-505 compliant System Clock Generator

- Video
- ServerEngines* Integrated BMC (Baseboard management controller)
- External 32 MB (or greater) DDR2 533 MHz memory
- VGA Video external connector
- Peripheral Interface (PCI Express* and PCI)
 - Two different PCI Express* configurations on a single board, dependent on board SKU
 - LX board SKU: One PCI Express* x16 and one PCI Express* x8 slot, connected to the PCI Express* ports of the MCH
 - LC board SKU: One PCI Express* x16 and one PCI Express* x8 slot, connected to the PCI Express* ports of the MCH; one PCI Express* x8 slot, connected to PCI Express* x4 interface of the ICH
 - L and V board SKUs: Two PCI Express* x8 slots, one connected to the PCI Express* x8 interface of the MCH and the other connected to the PCI Express* x4 interface of the ICH
- HDD Interface
 - Six SATA II ports, 300 MB/s
- USB
 - Two USB 2.0 ports connected to the server rear panel
 - Two USB 2.0 ports connected to headers on the server board
 - One USB 2.0 port connected to an internal vertical connector
- LAN
 - One Gigabit Ethernet device (82541PI, MAC + PHY) connect to PCI interfaces on the Intel® ICH9R
 - One Gigabit Ethernet PHY (82566DM) connected to the Intel® ICH9R through GLC/LCI interface (not in V board SKU)
 - Two 10/100/1000 Base-TX interfaces through RJ-45 connectors with integrated magnetics
 - Link and speed LEDs on the RJ-45 connector
- Power Supply
 - SSI EEB (Server System Infrastructure Electronic Bay) Power Connectors
 - On-board Power generation
 - VRD 11 processor core voltage
 - 1.2 V regulator for FSB VTT
 - 1.25 V regulator for MCH core and I/Osf
 - 1.05 V regulator for ICH9R core
 - 1.5 V regulator for the ICH9R I/O
 - 1.8 V for DDR2 and 0.9 V for DDR2 termination
 - 3.3 V SB voltage regulator
 - 1.8 V AUX, 1.2 V AUX, and 0.9 V AUX for Integrated BMC and the DDR2 memory supporting it

- System Management
 - Processor on die temperature monitoring through PECI (Platform Environment Control Interface)
 - Board temperature measurement
 - Fan speed monitoring and control
 - Voltage monitoring
 - IPMI-based (Intelligent Platform Management Interface) server management
- Battery
 - Socketed, Lithium coin cell-3 V
- Sockets
 - One LGA775 processor (Socket-T)
 - Four DDR2 DIMM Sockets
 - One battery (CR2032)
- Legacy Interfaces
 - Serial
 - Floppy
 - PS/2 keyboard
 - PS/2 mouse
- Power Management Modes Supported (ACPI [Advanced Configuration and Power Interface] Sleep states)
 - S0 – Full on
 - S1 – Power-on-suspend
 - S4 – Suspend to Disk
 - S5 – Soft on/off
- Connectors List
 - Four 240-Pin DDR2 DIMM connectors
 - PCI Express*, PCI-X, and PCI connectors (see SKU specific information)
 - One RJ-45 Connectors with magnetics and LEDs
 - One stacked RJ-45 with magnetics and LEDs and two-USB combo connector
 - 34-pin floppy drive connector
 - One serial port headers
 - Dual-stacked PS/2 keyboard and mouse connector
 - USB connectors (two stacked on the rear panel and three on the server board headers)
 - SSI-EEB ATX power connectors
 - One 4-pin auxiliary power connector
 - One stacked DB-15 VGA/DB-9 serial port connector
 - Six 7-pin SATA II connectors
 - 60-pin XDP connector
 - Four 4-pin, 0.10-inch pitch fan headers
 - 24-Pin, SSI-EEB, front panel connector

- One 4-pin SATA RAID Key
- One 2-pin intrusion detection
- BIOS
 - EFI BIOS
- Power Management
 - Support for Power Management of all capable components
 - ACPI-compliant motherboard and BIOS
 - Sleep Switch and dual mode LED indicator
- Manufacturing
 - Surface mount technology. Single-sided assembly for LC/V board SKUs and double-sided assembly for the LX board SKU
 - Six-layer PCB
- Form Factor
 - ATX 2.0, 12-inches x 9.6-inches, 1U thermally optimized, and SSI TEB Rev 2.11 compatible.
- Universal Serial Bus 2.0 (USB)
 - Two external USB ports (located at the rear panel) with an additional internal header providing two optional USB ports for front panel support
 - Supports wake-up from ACPI sleeping states S1 and S4 (S3 is not supported)
 - Supports legacy keyboard/mouse connections when using a PS/2-USB dongle
- LPC (Low Pin Count) bus segment with one embedded device
 - Super I/O controller (SMSC* SCH5027D) providing all PC-compatible I/O (floppy, serial, keyboard, mouse, two serial com ports) and integrated hardware monitoring.
- SSI-compliant connectors for SSI interface support
- Standard 24-pin SSI front panel, 2x12 main power connector, and 2x4 CPU power connector
- Fan Support
 - Five general purpose 4-pin fan headers
 - One 4-pin processor fan header (active heat sink required)
 - Four 4-pin system fan headers (3-pin fans are compatible with all fan headers. You should only use 4-pin fans with Sys Fan 1 and Sys Fan 2; Sys Fan 3 and Sys Fan 4 are connected to the PWM processor, which is programmed to work with the 4-pin active heat sink fan.)
- Diagnostic LEDs to display POST (Power-on Self-Test) code indicators during boot
- Onboard SATA RAID
 - Intel® Matrix Storage Technology supports software SATA RAID 0, 1, 10 and 5; Microsoft Windows* driver support only.

The following figure shows the board layout of the LX board SKU. A letter (shown in Table 1) identifies each connector and major component.

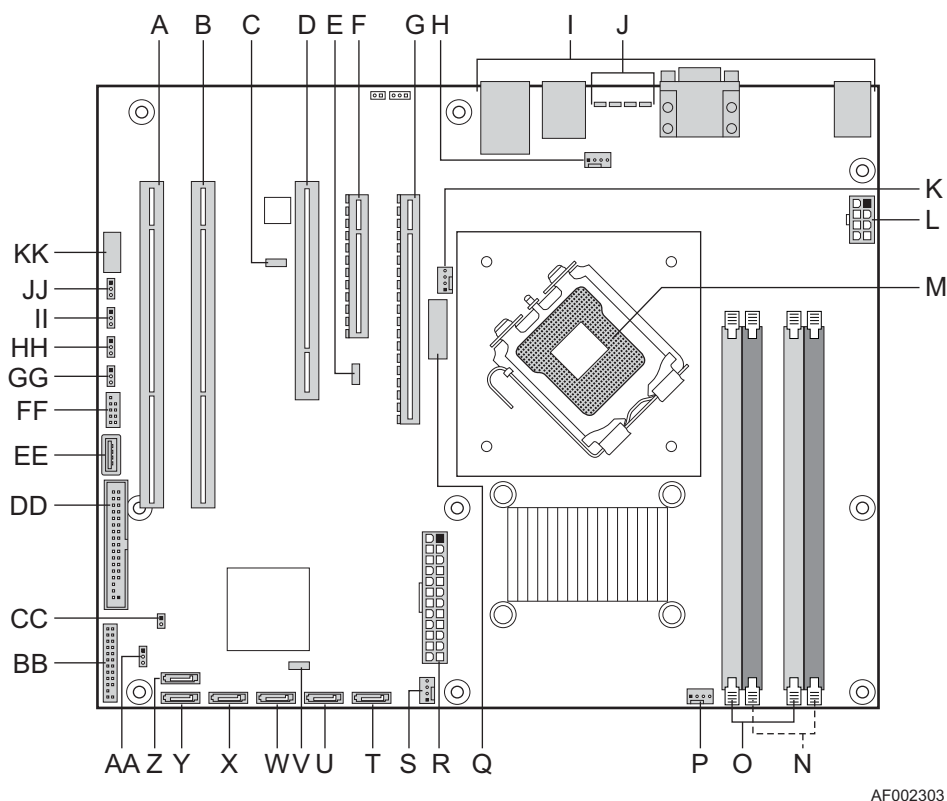

AF002303

Figure 1. Intel® Server Board S3210SHLX Diagram

Table 1. Intel® Server Board S3210SHLX Board SKU Layout Reference

Ref	Description	Ref	Description	Ref	Description
A	PCI-X (64-bit/133 MHz) Slot 1	N	Channel 2 DIMM Sockets	AA	Password Clear Jumper
B	PCI-X (64-bit/133 MHz) Slot 2	O	Channel 1 DIMM Sockets	BB	Front Panel Connector
C	IPMB	P	Processor Fan 2 Connector	CC	Chassis Intrusion Jumper
D	PCI 5 V (32-bit/33 MHz) Slot 3	Q	Battery	DD	Floppy Connector
E	HSBP	R	Main Power Connector	EE	Internal USB
F	PCI Express* x8	S	System Fan 2 Connector	FF	External USB
G	PCI Express* x16	T	SATA 0	GG	CMOS Clear Jumper
H	System Fan 1 Connector	U	SATA 1	HH	BMC Force Update Jumper
I	Back Panel Connectors	V	SGPIO	II	BIOS Recovery Jumper
J	Diagnostic LEDs	W	SATA 2	JJ	BMC Boot Block WP Jumper
K	Processor Fan 1 Connector	X	SATA 3	KK	Serial Port Connector
L	2X4 Aux Power Connector	Y	SATA 4		
M	Processor Socket	Z	SATA 5		

The following figure shows the board layout of the LC board SKU. A letter identifies each connector and major component (shown in Table 2).

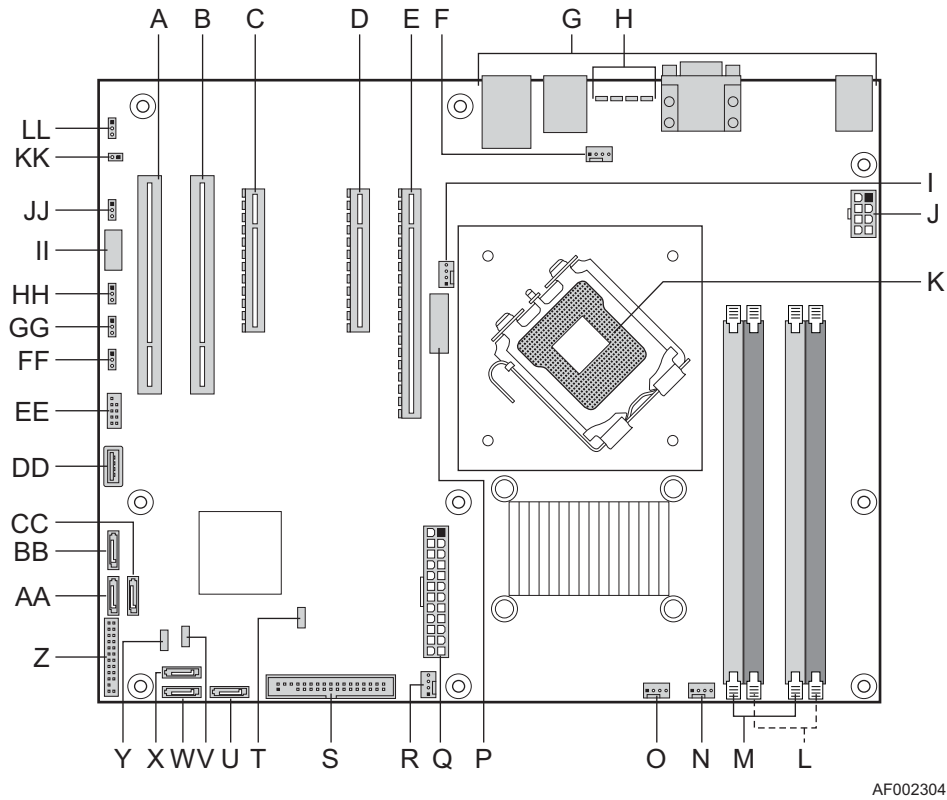
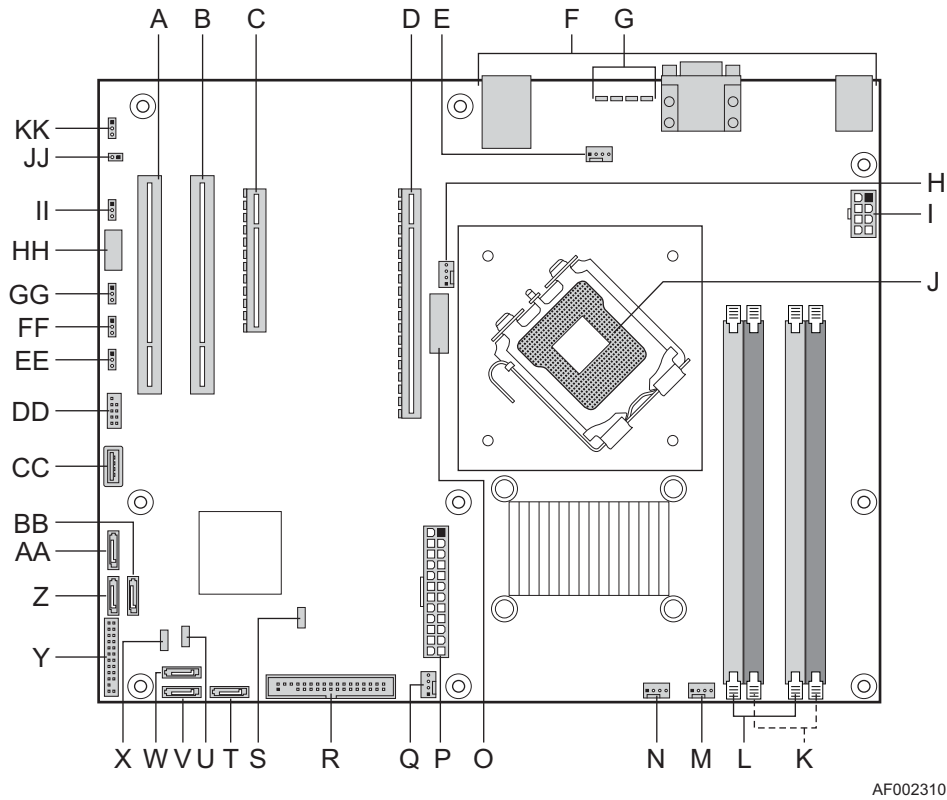

Figure 2. Intel® Server Board S3210SHLC Diagram

Table 2. Intel® Server Board S3210SHLC Layout Reference

Ref	Description	Ref	Description	Ref	Description
A	PCI (32-bit/33 MHz) Slot 1	N	System Fan4 Connector	AA	SATA 4
B	PCI (32-bit/33 MHz) Slot 2	O	System Fan3 Connector	BB	SATA 5
C	PCI Express* x8 (x8 lane)	P	Battery	CC	SATA 3
D	PCI Express* x8 (x4 lane)	Q	Main Power Connector	DD	Internal USB
E	PCI Express* x16	R	System Fan2	EE	External USB
F	System Fan 1 Connector	S	Floppy Connector	FF	CMOS Clear Jumper
G	Back Panel Connectors	T	SGPIO	GG	Password Clear Jumper
H	Diagnostic LEDs	U	SATA 0	HH	Recovery Mode Jumper
I	Processor Fan 1 Connector	V	HSBP	II	Serial Port
J	2X4 Aux Power Connector	W	SATA1	JJ	BMC Boot Block WP Jumper
K	Processor Socket	X	SATA2	KK	Chassis Intrusion
L	Channel 2 DIMM Sockets	Y	IPMB	LL	BMC Force Update Jumper
M	Channel 1 DIMM Sockets	Z	Front Panel Connector		

The following figure shows the board layout of the Intel® Server Boards S3200SHL/S3200SHV. A letter identifies each connector and major component (shown in Table 3).



AF002310

Figure 3. Intel® Server Board S3200SH-L/S3200SH-V SKU Diagram

Table3. Intel® Server Boards S3200SH-L/S3200SH-V Component Layout Reference

Ref	Description	Ref	Description	Ref	Description
A	PCI (32-bit/33 MHz) Slot 1	M	System Fan4 Connector	Y	Front Panel Header
B	PCI (32-bit/33 MHz) Slot 2	N	System Fan3 Connector	Z	SATA 4
C	PCI Express* x8 (x4 lane)	O	Battery	AA	SATA 5
D	PCI Express* x16 (x8 lane)	P	Main Power Connector	BB	SATA 3
E	System Fan 1 Connector	Q	System Fan2	CC	Internal USB
F	Back Panel Connectors	R	Floppy Connector	DD	External USB
G	Diagnostic LEDs	S	SGPIO	EE	CMOS Clear Jumper
H	Processor Fan 1 Connector	T	SATA 0	FF	Password Clear Jumper
I	2X4 Aux Power Connector	U	HSBP	GG	Recovery Mode Jumper
J	Processor Socket	V	SATA1	HH	Serial Port
K	Channel 2 DIMM Sockets	W	SATA2	II	BMC Boot Block WP Jumper
L	Channel 1 DIMM Sockets	X	IPMB	JJ	Chassis Intrusion
				KK	BMC Force Update Jumper

2.2 Server Board Layout

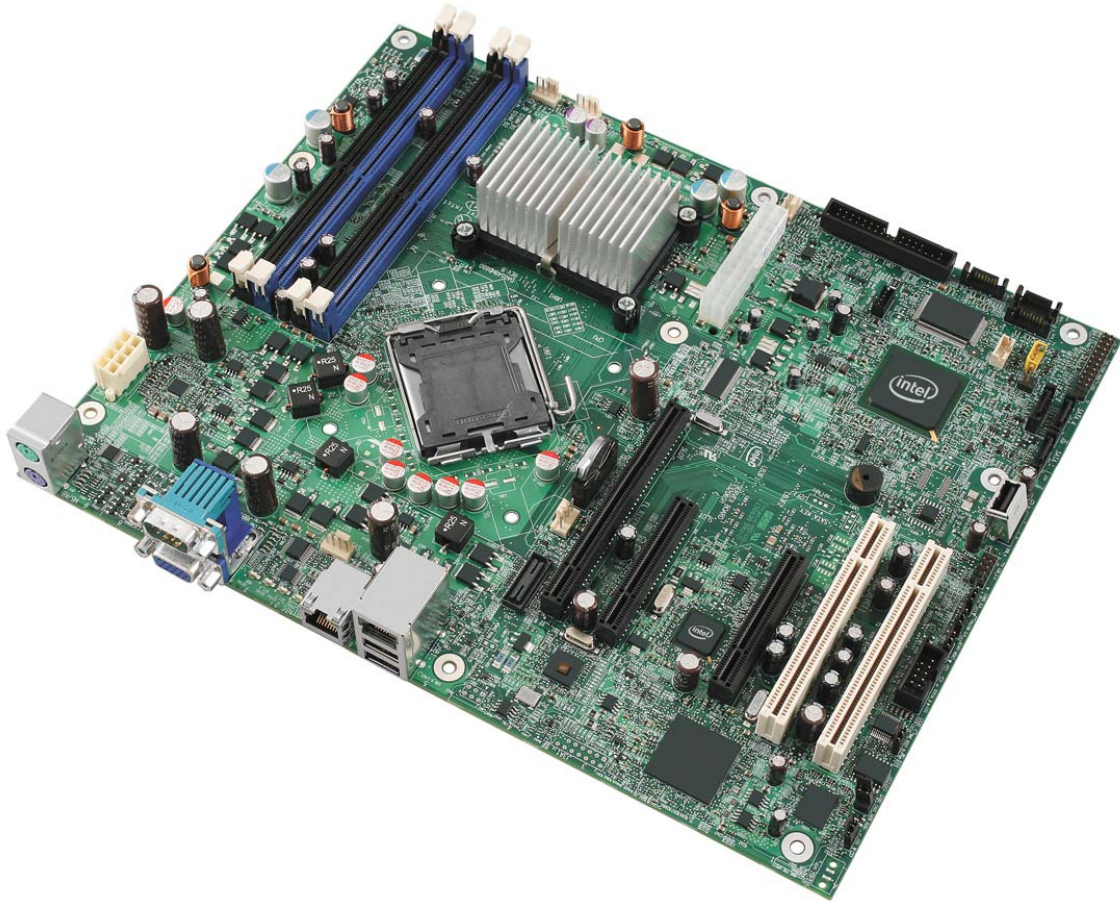

Figure 4. Intel® Server Board S3210SHLC

2.2.1 Server Board Mechanical Drawings

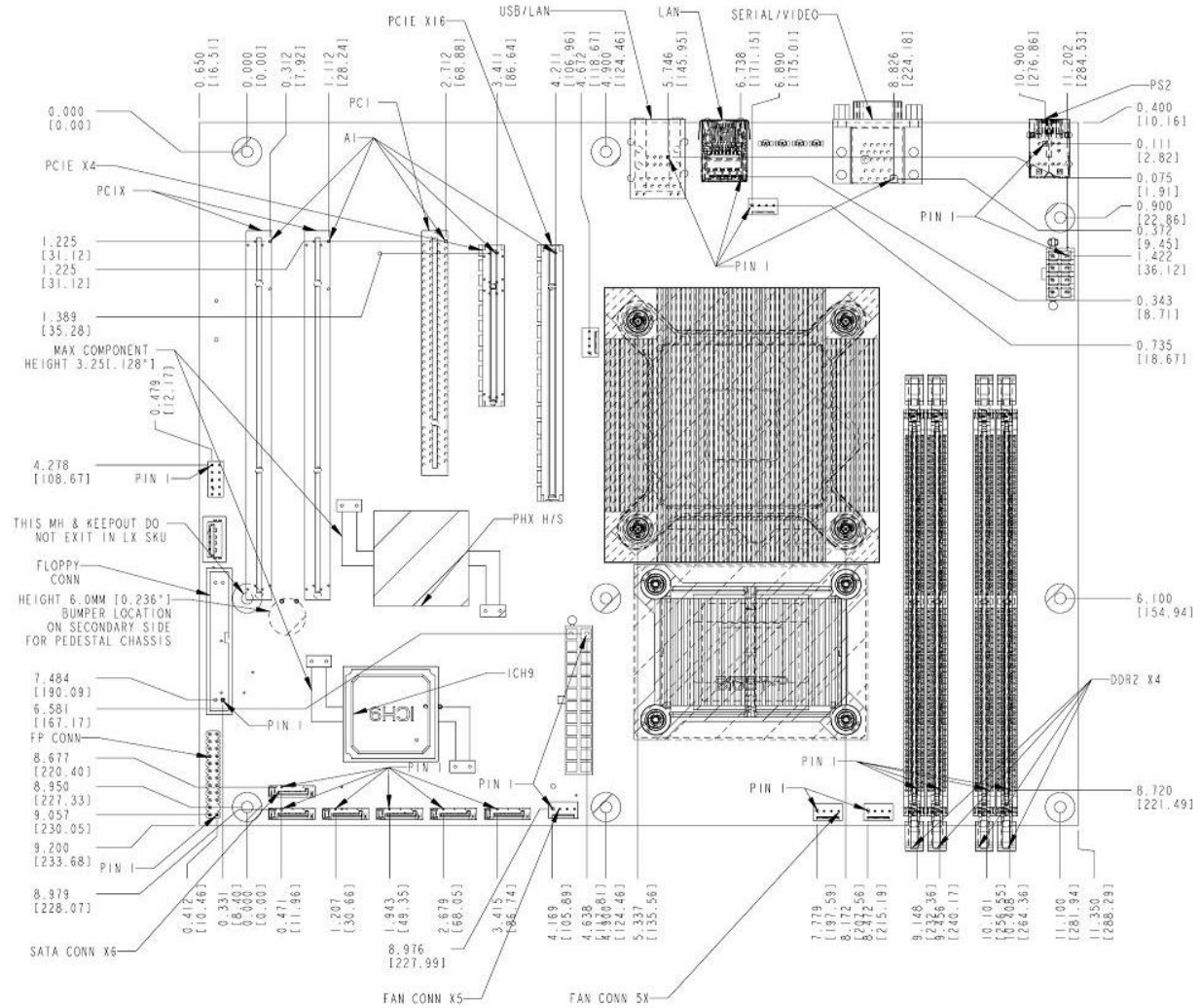

Figure 5. Intel® Server Board S3210SHLX – Hole and Component Positions

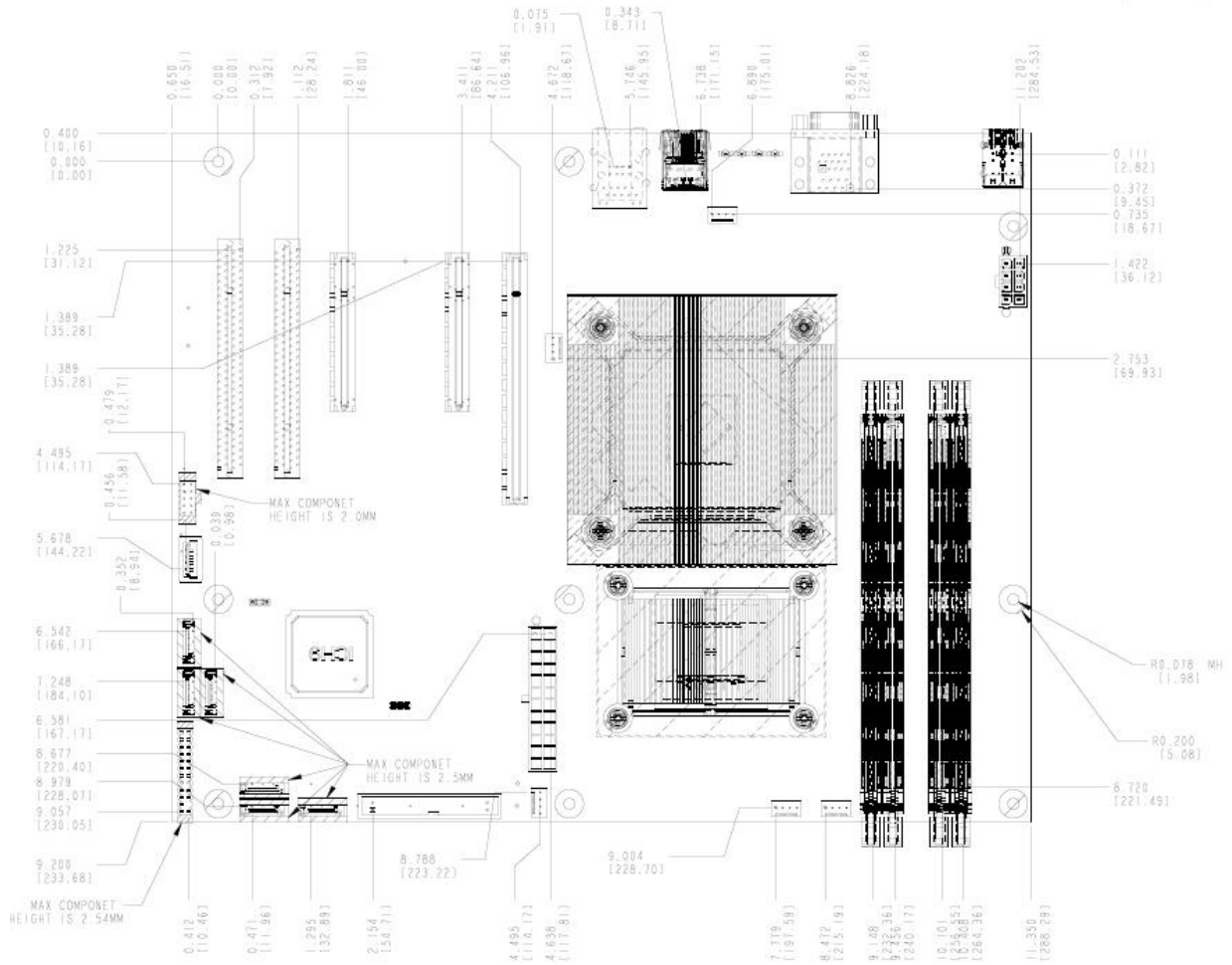

Figure 6. Intel® Server Boards S3210SHLC/S3200SHL/S3200SHV – Hole and Component Positions

3. Functional Architecture

This chapter provides a high-level description of the functionality associated with the architectural blocks that make up the Intel® Server Boards S3200SH/S3210SH.

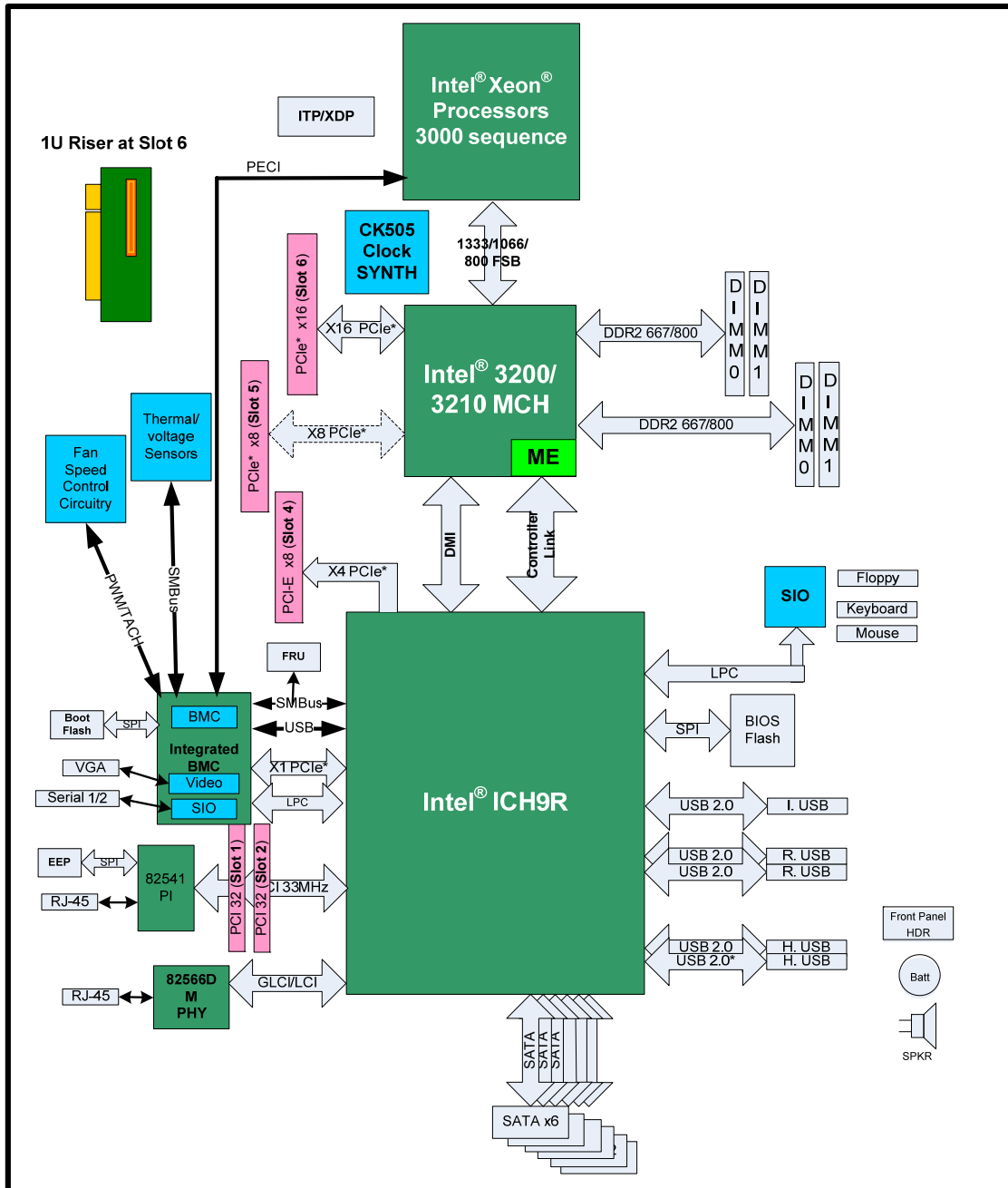

Figure 7. Intel® Server Boards S3200SH/S3210SH LC/LV SKU—Block Diagram

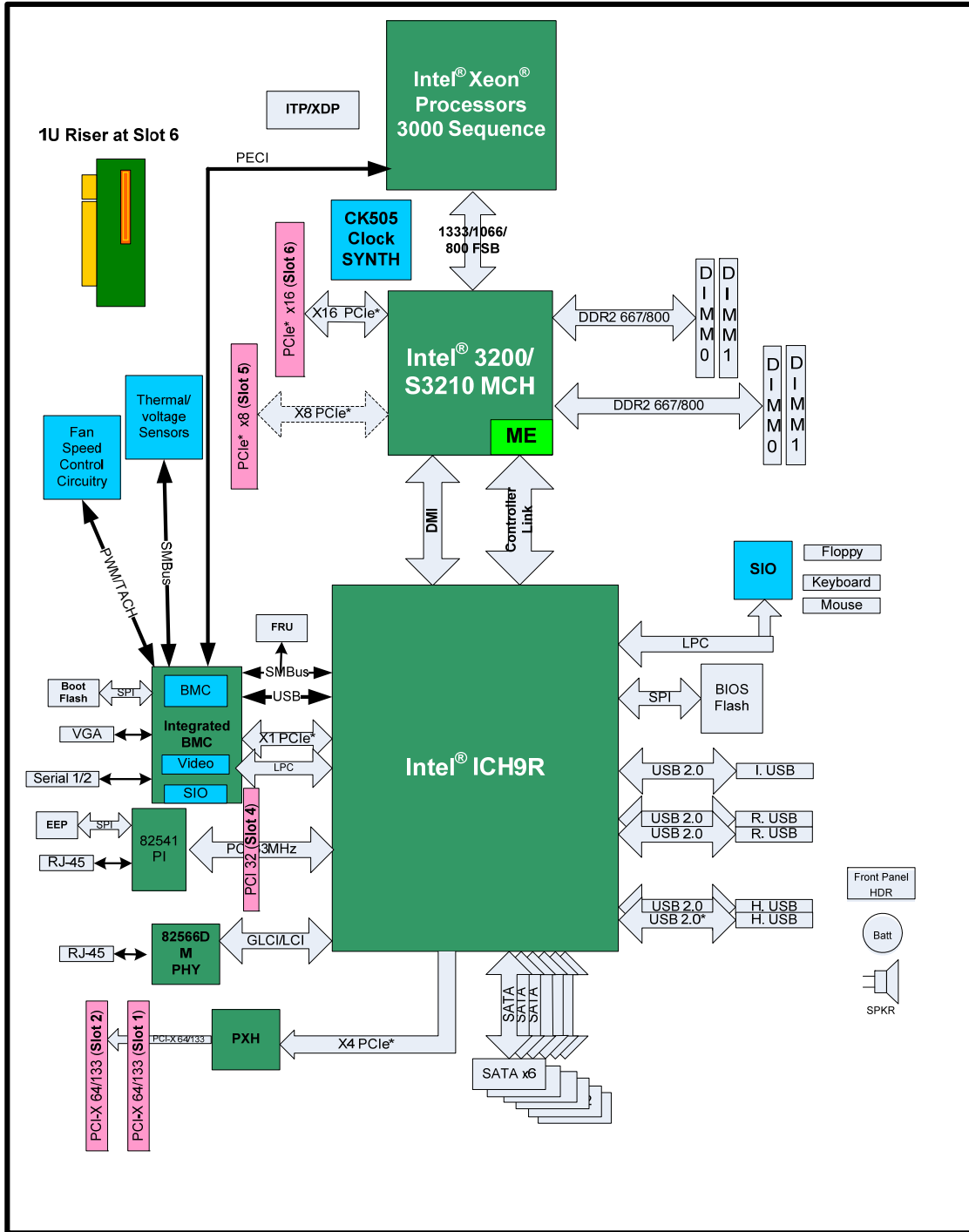

Figure 8. Intel® Server Systems S3200SH/S3210SH LX SKU-Block Diagram

3.1 Processor Sub-System

The server board supports the following processors:

- Intel® Xeon® processor 3000 series
- Intel® Xeon® processor 3100 series
- Intel® Xeon® processor 3200 series
- Intel® Xeon® processor 3300 series

The server board does not support the following processors:

- All Intel® 5XX and 6XX series processors
- All Intel® 8XX and 9XX series processors

The processors built on 65 nm (nanometer) and 45 nm process technology in the 775-land package use Flip-Chip Land Grid Array (FC-LGA4) package technology, and plug into a 775-land LGA socket, referred to as the Intel® LGA775 socket.

The processors in the 775-land package are based on the same core micro-architecture. They maintain compatibility with 32-bit software written for the IA-32 instruction set, while supporting 64-bit native mode operation when coupled with supported 64-bit operating systems and applications.

3.1.1 Processor Voltage Regulator Down (VRD)

The server board has a VRD (Voltage Regulator Down) to support one processor. It is compliant with the *VRD 12 DC-DC Converter Design Guide Line* and provides a maximum of 125 A.

The board hardware monitors the processor VTTEN (Output enable for VTT) pin before turning on the VRD. If the VTTEN pin of the processors is not asserted, the Power ON Logic will not turn on the VRD.

3.1.2 Reset Configuration Logic

The BIOS determines the processor stepping and processor cache size through the CPUID instruction. The processor information is read at every system power-on.

Note: The processor speed is the processor power-on reset default value. No manual processor speed setting options exist either in the form of a BIOS setup option or jumpers.

Table 3. Processor Support Matrix

Process Name	Socket	Core Frequency	Cache size	FSB Frequency
Intel® Xeon® processor 3000 series	Intel® LGA775	1.86 GHz – 2.66 GHz	2 MB or 4 MB	1066 MHz
Intel® Xeon® processor 3100 series	Intel® LGA775	TBD	TBD	1333 MHz
Intel® Xeon® processor 3200 series	Intel® LGA775	2.13 GHz – 2.40 GHz	8 MB	1066 MHz
Intel® Xeon® processor 3300 series	Intel® LGA775	TBD	TBD	1333 MHz

3.2 Intel® 3200/3210 Chipset

The server board is designed around the Intel® 3200/3210 Chipset. The chipset provides an integrated I/O bridge and memory controller, and a flexible I/O subsystem core (PCI Express*). The chipset consists of three primary components.

3.2.1 Intel® 3200/3210 Chipset MCH: Memory Control Hub

The Intel® 3200/3210 Chipset is designed for use with Intel® processors in a UP server platform. The role of the MCH in the system is to manage the flow of information between its four interfaces:

- Processor Interface (FSB)
- System Memory Interface (DDR2)
- DMI interface to the Intel® ICH9R South Bridge
- PCI Express* connectivity to one or two PCI Express* x8 connectors

The feature list of the MCH includes:

- Processor / Host Interface
 - Supports LGA775 processors in an UP System configuration
 - 200/266/333 MHz FSB Clock frequency
 - GTL+ bus drivers with integrated GTL termination resistors
- System Memory Controller
 - Supports 512 Mbit and 1 Gbit memory technologies
 - DDR2 – 667, 800 MHz
 - 8 GB addressable memory
 - Supports unbuffered, ECC and non-ECC DIMMs
 - No support for DIMMs less than 512 MB and memory speeds less than 667 MHz
- DMI Interface

- Interface to ICH9R South Bridge
- 100 MHz reference clock shared with PCI Express* interface(s)
- PCI Express* x8 Interface
 - Connected to two PCI Express* X8 connectors as shown in the block diagram
 - Compliant with the PCI Express* base specification

The MCH accepts access requests from the host (processor) bus and directs those accesses to memory or to one of the PCI Express* or PCI buses. The MCH monitors the host bus, examining addresses for each request. Accesses may be directed to the following queues:

- A memory request queue for subsequent forwarding to the memory subsystem
- An outbound request queue for subsequent forwarding to one of the PCI Express* or PCI buses

The MCH also accepts inbound requests from the Intel® ICH9R. The MCH is responsible for generating the appropriate controls to control data transfer to and from memory.

The MCH is a FC-BGA device and uses the proven components of the following previous generations:

- Hub interface unit
- PCI Express* interface unit
- DDR2 memory interface unit

The MCH incorporates an integrated PCI Express* interface. The PCI Express* interface allows the MCH to directly interface with the PCI Express* devices. The MCH also increases the main memory interface bandwidth and maximum memory configuration with a 72-bit wide memory interface.

The MCH integrates the following main functions:

- An integrated high performance main memory subsystem
- A PCI Express* bus which provides an interface to the PCI Express* devices (Fully compliant to the PCI Express* Base Specification, Rev 1.0a)
- A DMI which provides an interface to the Intel® ICH9R

Other features provided by the MCH include the following:

- Full support of ECC on the processor bus
- Twelve deep in-order queue, two deep defer queue
- Full support of unbuffered DDR2 ECC DIMMs
- Support for 512 MB, 1 GB, and 2 GB DDR2 memory modules

3.2.1.1 Segment F PCI Express* x8

The MCH PCI Express* Lanes 0~7 provide an x8 PCI Express* connection directly to the MCH. This resource can support x1, x4, and x 8 PCI Express* add-in cards or cards through the I/O riser when using the riser slot for the L board SKU.

Table 4. Segment F Connections

Lane	Device
Lane 0~7	Slot 6 (PCI Express* x16 with 8 Lanes layout)

3.2.1.2 MCH Memory Sub-System Overview

The MCH supports a 72-bit wide memory sub-system that can support a maximum of 8 GB of DDR2 memory using 2 GB DIMMs. This configuration needs external registers for buffering the memory address and control signals. The four chip selects are registered inside the MCH and need no external registers for chip selects.

The memory interface runs at 667/800 MT/s. The memory interface supports a 72-bit wide memory array. It uses seventeen address lines (BA [2:0] and MA [13:0]) and supports 512 MB, 1 GB, and 2 GB DRAM densities. The DDR DIMM interface supports single-bit error correction, and multiple bit error detection.

3.2.1.3 DDR2 Configurations

The DDR2 interface supports up to 8 GB of main memory and supports single- and double-density DIMMs. The DDR2 can be any industry-standard DDR2. The following table shows the DDR2 DIMM technology supported.

Table 5. Supported DDR2 Modules

DDR2-667/800 Un-buffered SDRAM Module Matrix					
DIMM Capacity	DIMM Organization	SDRAM Density	SDRAM Organization	# SDRAM Devices/rows/Banks	# Address bits rows/Banks/column
512 MB	64M x 72	256 Mbit	32M x 8	18 / 2 / 4	13 / 2 / 10
512 MB	64M x 72	512 Mbit	64M x 8	9 / 1 / 4	14 / 2 / 10
1 GB	128M x 72	512 Mbit	64M x 8	18 / 2 / 4	14 / 2 / 10
1 GB	128M x 72	1 Gbit	128M x 8	9 / 1 / 8	14 / 4 / 10
2 GB	256M x 72	2 GB	128M x 8	18 / 2 / 8	14 / 8 / 10

3.2.1.4 Memory Population Rules and Configurations

You must follow a few rules when populating memory. The server board supports two DDR2 DIMM slots for channel A and two DDR2 DIMM slots for channel B. They are placed in a row and numbered from 0 to 3 with DIMM0 being closest to the MCH. The four slots are partitioned with channel A representing the channel A DIMMs (DIMM0 and DIMM1) and channel B representing the channel B DIMMs (DIMM2 and DIMM3).

Note the following memory population rules:

- If dual-channel operation is needed, you must populate channel A and channel B identically (for example, same capacity).
- Use DDR2 667/800 MHz memory only.
- The slowest DIMM in the system determines the speed used on all the channels.

- Supports ECC or non-ECC DIMMs.
- Different memory technologies (size and density) can be used.
- Single Channel Mode (either channel can be used): DIMM slots (within the same channel) may be populated in any order.
- Dual Channel Interleaved Mode: DIMM slots can be populated in any order as long as the total memory in each channel is the same.
- Dual Channel Asymmetric Mode: DIMM slots may be populated in any order.

3.2.2 PCI-X Hub (LX board SKU only)

The PCI-X Hub (PXH-V) is a peripheral chip that performs PCI/PCI-X bridging functions between the PCI Express* interface and the PCI/PCI-X bus. The PXH-V contains two PCI bus interfaces that can be independently configured to operate in PCI (33 or 66 MHz) or PCI-X mode (66, 100, or 133 MHz), for either 32 or 64 bits.

3.2.2.1 Segment E 64bit/133MHz PCI-X Subsystem

One 64-bit PCI-X bus segment is directed through the PXH-V. This PCI-X segment (segment E) provides the following:

- Two 3.3 V 64-bit PCI-X slots

On Segment E, PCI-X is capable of speeds up to 133 MHz operation and supports full-length PCI and PCI-X adapters.

3.2.2.1.1 Device IDs (IDSEL)

Each device under the PCI-X hub bridge has an IDSEL signal connected to one bit of AD [31:16], which acts as a chip select on the PCI-X bus segment in configuration cycles. This determines a unique PCI-X device ID value for use in configuration cycles. The following table shows the bit to which each IDSEL signal is attached for P64-C devices and a corresponding device description.

Table 6. Segment E Configuration IDs

IDSEL Value	Device
18	PCI-X Slot 1 (64-bit/66-133 MHz) (LX board SKU only)
17	PCI-X Slot 2 (64-bit/66-133 MHz) (LX board SKU only)

3.2.2.1.2 Segment E Arbitration

The PXH-V supports two PCI masters: two PCI-X slots or one riser slot. All PCI masters must arbitrate for PCI access using resources supplied by the PXH-V. The host bridge PCI interface (PXH-V) arbitration lines REQx* and GNTx* are a special case because they are internal to the host bridge. Table 7 defines the arbitration connections.

Table 7. Segment D Arbitration Connections

Baseboard Signals	Device
PCIX REQ_N1/GNT_N1	PCI-X Slot 1 (64-bit/66-133 MHz) (LX board SKU only)
PCIX REQ_N0/GNT_N0	PCI-X Slot 2 (64-bit/66-133 MHz) (LX board SKU only)

3.2.3 Intel® ICH9R: I/O Controller Hub 9R

3.2.3.1 Direct Media Interface (DMI)

DMI is the name given to the chip-to-chip connection between the Memory Controller Hub and the Intel® ICH9. DMI is a x4 link that mostly adheres to the PCI Express* specification. Deviations of the DMI from standard PCI Express* specifications are described in the Intel® ICH9 CSPEC.

3.2.3.2 Controller Link (M-Link)

Controller Link is the name given to the interconnect that connects the north bridge (MCH) to the LAN Controller in the Intel® ICH9. The Management Engine (ME) resides in the MCH and communicates with the ICH9 LAN Controller over this interface.

3.2.3.3 PCI Express* Interfaces

The ICH9R provides six PCI Express* root ports (GEN1) which are compliant with the *PCI Express* Base Specification*, Revision 1.1. You can statically configure the PCI Express* root ports 1-4 as four x 1 ports, or ganged together to form two x 2 ports, one x 2 with two x1 ports, or one x4 port. Ports 5 and 6 can only be used as two x1 ports or one x2. The x4 configuration supports lane reversal. Each Root Port fully supports 2.5 Gb/s bandwidth in each direction.

The root ports 1-4 are combined to form a single x4 link connecting to a PCI Express* x8 connector. Port 5 and 6 are used to support the dual GBe LAN channels.

3.2.3.4 Serial ATA II Interface

The Intel® ICH9 has an integrated SATA II host controller that supports independent DMA operation on the six Ports and supports data transfer rates of up to 300 MB/Sec. The SATA II controller provides two modes of operation – a legacy mode using I/O space and an Advanced Host Controller Interface (AHCI) mode using memory space.

3.2.3.5 PCI Interface

The Intel® ICH9 PCI interface provides a 33 MHz, 3.3 V, Revision 2.3 implementation. Except for PME#, all PCI signals are 5 V tolerant. The ICH9 integrates a PCI arbiter that supports up to seven external PCI bus masters in addition to the internal ICH9 requests. This allows for combinations of up to four PCI down devices and/or PCI slots.

The server board supports one NIC, the 82541PI Gigabit Ethernet controller, and two PCI slots.

3.2.3.6 Low Pin Count Interface (LPC)

The Low Pin Count interface on the Intel® ICH9 provides a low system cost design interface solution for connecting the Super I/O for the legacy interfaces such as the parallel port, serial port, floppy drive, and so on.

3.2.3.7 Compatibility Modules

The Intel® ICH9 incorporates various compatibility modules such as DMA controller, timer/counters, and interrupt controller. The DMA controller incorporates the logic of two 8237 DMA controllers with seven independently programmable channels. Channels 0 to 3 are hardwired to 8-bit, count-by-byte transfers and channels 5 to 7 are hardwired to 16-bit, count-by-word transfers. DMA channel 4 is used to cascade the two 8327 controllers together. The DMA controller is used to support the LPC DMA.

The LPC DMA is handled through the LDRQ# lines from peripherals and special encoding on LAD[3:0] from the host.

The timer/counter block contains three counters equivalent in function to those found in one 8254 programmable internal timer. These three counters are combined to provide the system timer function and speaker tone. The 14.318 MHz oscillator input provides the clock source for these three counters.

The Intel® ICH9 provides an ISA compatible Programmable Interrupt Controller (PIC) that incorporates the functionality of two 8259 interrupt controllers. Each 8259 supports eight interrupts that are cascaded with one master controller interrupt 2 for fifteen programmable interrupts. The interrupts are system timer, keyboard controller, serial ports, parallel ports, floppy disk, mouse, DMA channels, and mapped PCI-based interrupts.

3.2.3.8 Universal Serial Bus (USB) Controller

The Intel® ICH9 contains two EHCI and six UHCI USB controllers providing support for twelve USB 2.0 ports. All twelve ports are high-speed, full-speed, and low-speed capable. The port routing logic of the Intel® ICH9 determines whether a USB port is controlled by one of the UHCI controllers or by the EHCI controller. The Intel® ICH9 also implements a USB 2.0 based debug port.

3.2.3.9 Real Time Clock (RTC)

The Intel® ICH9 contains a Motorola MS146818A* functionally compatible Real-Time Clock (RTC) with two 128-Byte banks of battery backed RAM. The RTC performs two key functions on the server board:

- Keeping track of the time of day
- Storing system configuration data even when the system is powered down.

The RTC operates on a 32.768 KHz (Kilohertz) crystal and a 3 V lithium battery.

3.2.3.10 GPIO

The Intel® ICH9 contains 61 General Purpose Inputs and Outputs (GPIO) for custom system design.

3.2.3.11 Enhanced Power Management

The Intel® ICH9 supports the Advanced Configuration and Power Interface, Version 2.0 (ACPI) that provides power and thermal management. The ICH9 also supports the Manageability Engine Power Management Support for new wake events from the MCH Management Engine.

The server board fully complies with the Advanced Configuration and Power Interface (ACPI) specifications, Revision 2.0.

3.2.3.12 System Management Interface

The Intel® ICH9 functions as a SMBus host controller and allows the processor to communicate with SMBus slaves. This interface is compatible with most I²C devices. The ICH9 also supports slave functionality. The SMBus logic exists in device 31: function 3 configuration space.

3.2.3.13 Intel® Quiet System Technology (Intel® QST)

The Intel® ICH9 integrates two thermal sensors that monitor the temperature within the die. Those sensors support Intel® Quiet System Technology (Intel® QST). Intel® QST is controlled by the management engine (ME) residing in the MCH and requires SPI flash to host the Intel® QST firmware.

The Intel® ICH9 integrates four fan speed TACH sensors and three fan speed controllers, PWMs. Up to four system fans can be monitored and controlled. The ICH9 implements a single wire Simple Serial Transport (SST) bus that allows connection of up to five SST thermal or voltage monitoring devices. The ICH9 also supports the Platform Environmental Control Interface (PECI) that provides access to the CPU thermal data.

The server board does not support ME or Intel® QST. The integrated BMC firmware controls the fan speed.

3.2.3.14 Serial Peripheral Interface (SPI)

The Serial Peripheral Interface (SPI) is a 4-pin interface that provides a potentially lower-cost alternative for the system flash versus the Firmware Hub on the LPC Bus. The Intel® ICH9 supports two SPI flash components using two separate chip select pins. Each component can be up to 16 MB in size and operate in SPI Fast Read Instructions at frequencies of 20 MHz or 33 MHz.

The SPI Interface consists of the following components:

- Clock (CLK)
- Master Out Slave In (MOSI)
- Master In Slave Out (MISO)
- Chip Select (CS#)

The SPI uses a Master – Slave protocol for communication.

The SPI flash may operate in two operational modes: descriptor and non-descriptor. When operating in non-descriptor mode, the SPI Flash can only support the BIOS through register accesses.

When operating in descriptor mode, the ICH9 allows a single SPI flash device to store system BIOS, Firmware, and Gigabit Ethernet EEPROM information.

When SPI is selected by the Boot BIOS Destination Strap and a SPI Device is detected by the Intel® ICH9, LPC-based BIOS Flash is disabled. The boot destination strap is sampled by the ICH9 at pins GNT# and SPI_CS1# on the rising edge of the PWROK input. Alternately, the ICH9 supports soft straps when operating in Descriptor Mode. The ICH9 reads the soft strap data out of the SPI device prior to de-assertion of reset to the Manageability Engine and the Host system.

GNT# and SPI_CS1# are both pulled-up with soft resistors internal to the Intel® ICH9. The default BIOS flash without external straps is the FWH. For manufacturing or debugging support, the BIOS cycles may also be directed to the PCI bridge via the same external flash. Configurations other than the default are selected using 2.2K pull-up or pull-down resistors.

The server board supports the boot BIOS Destination Selection as defined in Table 8.

Table 8. Boot BIOS Destination Selection

GNT#	SPI_CS1#	ROUTING
0	1	Flash Cycles Routed to SPI (Default)
1	0	Flash Cycles Routed to PCI (Test only)
1	1	Flash Cycles Routed to LPC (Test only)

The SPI flash meets the following requirements:

- Erase size capability of 4 Kbyte or 64 Kbyte
- SPI device meets the command set per Table 9

For streamlined software development, command and opcode C7h (for Full Chip Erase) is recommended.

- Supports JEDEC ID OP Code 9FH.
- Supports multiple writes to a page without requiring a preceding command (minimum 512 writes).
- Ignores the upper address bit. For example, an address of FFFFFFFFh simply aliases to the top of the flash memory.
- Supports SPI Compatibility Mode 0.
- Receipt of an unsupported command causes a completed cycle without impact to the flash content.
- Minimum density of 16 Mb (BIOS + Gbe).
- To disable write protection, power up in an unlocked state or use the write status register.

Table 9. SPI Required Command Codes

Commands	Opcode	Notes
Write Status	01h	If the command is supported, the opcode

Commands	Opcode	Notes
		must be 01h.
Program Data	02h	Write Data / Program Data
Read Data	03h	
Write Disable	04h	
Read Status	05h	
Write Enable	06h	If the command is supported, the opcode must be 06h.
Fast Read	0Bh	
Enable Write Status Register	50 or 06h	
Erase	Programmable	256 B, 4 Kbyte, 8 Kbyte, or 64 Kbyte erase
JEDEC ID	9Fh	The JEDEC Standard Manufacturer and Device ID read method is defined in Standard JESD21-C, PRN03-NV1.

The SPI Flash Memory device is an Atmel AT26DF321*, 32-mbit, 2.7 to 3.6 V serial interface FLASH memory, Intel part number D64145-001/D64145-002. The AT26DF321 supports the block erase command opcodes 20H and D8H, providing, respectively, 4-Kbytes or 64-Kbytes block erase sizes. It installs directly onto the server board without the use of sockets.

3.2.3.15 Manageability

The Intel® ICH9 integrates several functions designed to manage the system and lower the total cost of ownership (TCO) of the system. These system management functions are designed to report errors, diagnose the system, and help the system recover from lockups without the aid of an external microcontroller.

The management engine includes the following features:

- A TCO Timer used to detect system locks
- A Process Present Indicator that can determine if the processor fetches the first instruction after reset
- ECC Error reporting from the host controller
- A Function Disable option to prevent disabled functions from generating interrupts and power management events
- An Intruder Detect input for system cases

3.2.3.16 Unused Intel® ICH9 Interfaces on the Server Board

The server board does not support the following interfaces in the Intel® ICH9:

1. AC'97 2.3 Controller – ICH9 integrates an Audio Codec '97 Component Specifications, Version 2.3 controller that can be used to attach an Audio Codec (AC), a Modem Codec (MC), an Audio/Modem Codec (AMC), or a combination of ACs and a single MC
2. Intel® High Definition Audio
3. The Management Engine (ME), SST, Fan tachometer and PWM, and PEC controller

3.2.3.17 PCI Express* x4 Sub-system

The Intel® ICH9R supports one PCI Express* x4-lane interface that can also be configured as a single x1 or x4-lane port. The PCI Express* interface allows direct connection with the PXH-V or dedicated PCI Express* devices. (Fully compliant with the *PCI Express* Base Specification, Rev 1.0a*).

3.2.3.18 PCI

One 32-bit PCI bus segment is directed through the Intel® ICH9R Interface defined as segment A. This PCI Segment A supports two PCI connectors and one embedded Intel® 82541PI LAN controller.

The Intel® ICH9R does not contain a PATA device controller in the chipset; therefore, SATA interface CD-ROM/DVD-ROMs are recommended for use with the server board.

3.2.3.19 SATA Controller

The Intel® ICH9R contains six SATA ports that support data transfer rates up to 300 Mbyte/s per port.

3.2.3.20 Compatibility Modules (DMA Controller, Timer/Counters, Interrupt Controller)

The Intel® ICH9R provides the functionality of two-cascaded 82C59 with the capability to handle 15 interrupts. It also supports processor system bus interrupts.

3.2.3.21 Advanced Programmable Interrupt Controller (APIC)

The APICs in the Intel® ICH9R use messages on the FSB for interrupt generation and notification to the processor.

3.2.3.22 Universal Serial Bus (USB) Controller

The Intel® ICH9R contains one EHCI USB 2.0 controller and can support four USB ports. The USB controller moves data between main memory and up to four USB connectors. All ports function identically and with the same bandwidth.

The server board provides two external USB ports on the rear panel of the server board. The dual-stack USB connector is located within the standard ATX I/O panel area. The *Universal Serial Bus Specification, Revision 1.1* defines the external connectors.

The third/fourth USB port is optional and can be accessed by cabling from an internal 9-pin connector located on the server board to an external USB port located either in front or the rear of a chassis.

3.2.3.23 Enhanced Power Management

One of the embedded features of the Intel® ICH9R is a power management controller. It implements ACPI-compliant power management features. The server board supports sleep states S1, S4, and S5.

3.3 Memory Sub-System

The server board supports up to four DIMM slots for a maximum memory capacity of 8 GB. The DIMM organization is x72, which includes eight ECC check bits. The memory interface runs at 533/667 MTs. The memory controller supports the following:

- Single-bit error correction
- Multiple-bit error detection
- Memory using 512 Mbit, 1 Gbit, or 2 Gbit DRAM based on memory technology

Memory can be implemented with either single-sided (one row) or double-sided (two rows) DIMMs.

3.3.1 Memory Configuration

The memory interface between the MCH and the DIMMs is a 72-bit (ECC) wide interface.

There are two banks of DIMMs, labeled 1 and 2. Bank 1 contains DIMM socket locations DIMM_1A and DIMM_2A. Bank 2 contains DIMM socket locations DIMM_1B and DIMM_2B. The sockets associated with each bank or “channel,” are located next to each other and the DIMM socket identifiers are marked on the server board silkscreen near the DIMM socket. Bank 1 is associated with Memory Channel A while Bank 2 is associated with Memory Channel B. When only two DIMM modules are used, the population order must be DIMM_1A, DIMM_1B to ensure dual channel operating mode. For more information, see Figure 9.

In order to operate in dual channel dynamic paging mode, the following conditions must be met:

- Two identical DIMMs are installed, one each in DIMM_1A and DIMM_1B
- Four identical DIMMs are installed (one in each socket location)

Note: Three DIMMs cannot be installed on the server board. This configuration is not supported. DIMMs that are not “matched” (same type and speed) are not supported. Identical memory parts are preferred.

The system is designed to populate any rank on either channel including either degenerate single channel case.

DIMM and memory configurations must adhere to the following:

- DDR2 667/800 MHz, unbuffered, DDR2 DIMM modules
- DIMM organization: x64 non-ECC or x72 ECC
- Pin count: 240
- DIMM capacity: 512 MB, 1 GB, and 2 GB DIMMs
- Serial PD: JEDEC Rev 2.0
- Voltage options: 1.8 V
- Interface: SSTL2

Table 10. Memory Bank Labels and DIMM Population Order

Location	DIMM Label	Channel	Population Order
J8J1	(DIMM_1A)	A	1
J8J2	(DIMM_2A)	A	3
J9J1	(DIMM_1B)	B	2
J9J2	(DIMM_2B)	B	4

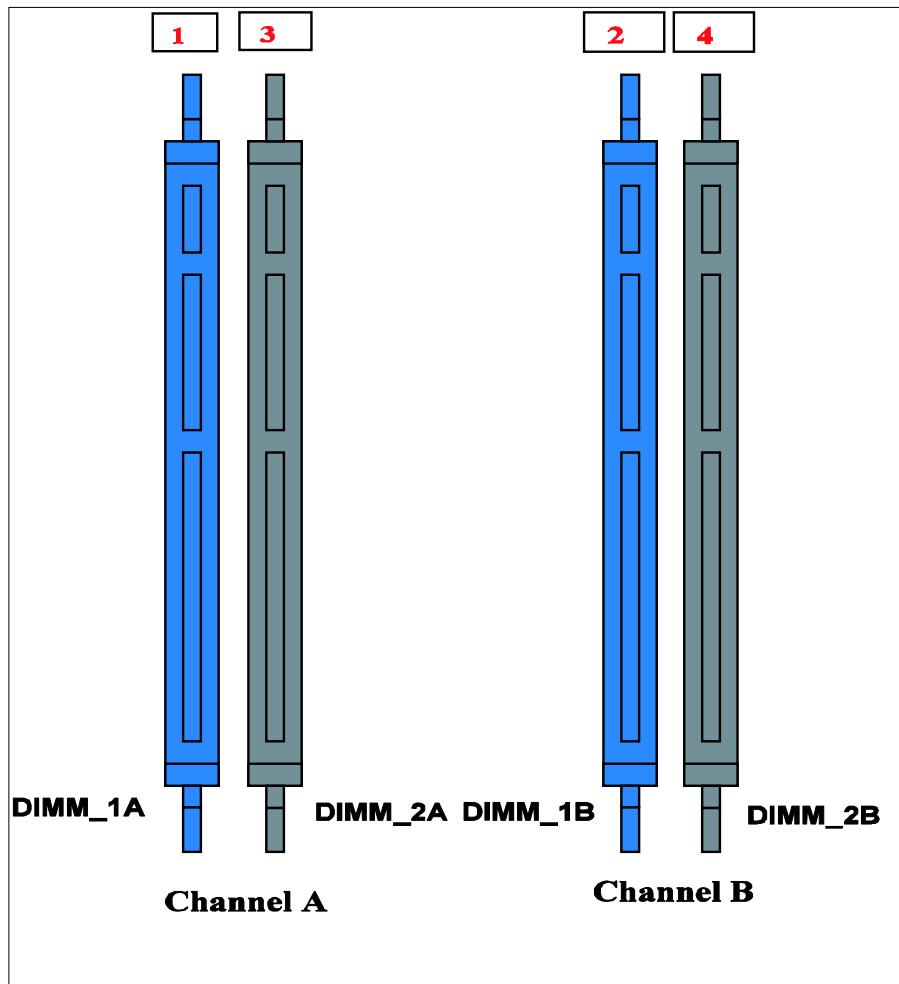

Figure 9. Memory Bank Label Definition

Table 11. Characteristics of Dual/Single Channel Configuration with or without Dynamic Mode

Throughput Level	Configuration	Characteristics
Highest	Dual channel with dynamic paging mode	All DIMMs matched
	Dual channel without dynamic paging mode	DIMMs matched from Channel A to Channel B DIMMs not matched within channels
	Single channel with dynamic paging mode	Single DIMM or DIMMs matched within a channel
Lowest	Single channel without dynamic paging mode	DIMMs not matched

3.3.2 Memory DIMM Support

The board supports unbuffered (not registered) DDR2 667/800 ECC or non-ECC DIMMs operating at 667/800 MT/s.

Note: Only DIMMs tested and qualified by Intel or a designated memory test vendor are supported on this board. All DIMMs are supported by design, but only fully qualified DIMMs are supported on the board.

The minimum supported DIMM size is 512 MB. Therefore, the minimum main memory configuration is 1 x 512 MB or 512 MB. The largest size DIMM supported is 2 GB and as such, the maximum main memory configuration is 8 GB implemented by 4 x 2 GB DIMMs.

- Unbuffered DDR2 667/800 compliant, ECC x8 and Non-ECC x8 or x16 memory DIMMs are supported.
- ECC single-bit errors (SBE) can be detected and corrected. Multiple-bit errors (MBE) can only be detected.
- The maximum memory capacity is 8 GB via four 2 GB DIMM modules.
- The minimum memory capacity is 512 MB via a single 512 MB DIMM module.

3.4 I/O Sub-System

3.4.1 PCI Subsystem

The primary I/O buses for the server board are five independent PCI bus segments providing PCI, PCI Express*, and PCI-X resources (LX board SKU only). The PCI buses comply with the *PCI Local Bus Specification, Rev 2.3*.

PCI segments A, B, C, and D are directed through the Intel® ICH9R. PCI segment E is independently configured to PXH-V which is through the Intel® ICH9R by PCI Express* x4 interface. PCI Segment F is directed through the MCH by PCI Express* x8 interface. Table 12 lists the characteristics of the three PCI bus segments.

Table 12. PCI Bus Segment Characteristics

PCI Bus Segment	Voltage	Width	Speed	Type	PCI I/O Card Slots
A	3.3V	32 bits	33 MHz	PCI 32	Slot 1, Slot 2, NIC 2, video
B	3.3V	1 lane	2.5 GHz	x1 PCI Express*	Slot 3, X4 physical connector
C	3.3V	1 lane	2.5 GHz	x1 PCI Express*	NIC 1
D	3.3V	4 lane	2.5 GHz	x4 PCI Express*	Slot 4, PXH, X8 physical connector
E	3.3V	64 bits	66/100/133 MHz	PCI-64	Slot 5, Slot 6 through riser card
F	3.3V	8 lanes	2.5 GHz	x8 PCI Express*	Slot 6, X8 physical connector

3.4.1.1 P32-A: 32-bit, 33-MHz PCI Sub-system

The Intel® ICH9R provides a Legacy 32-bit PCI sub-system and acts as the central resource on this PCI interface. P32-A supports the following embedded devices and connectors:

- One Intel® 82541PI Fast Ethernet Controller
- Two slots capable of supporting full length PCI add-in cards operating at 33 MHz

3.4.1.1.1 Device IDs (IDSEL)

Each device under the PCI hub bridge has its IDSEL signal connected to one bit of AD (31:16), which acts as a chip select on the PCI bus segment in configuration cycles. This determines a unique PCI device ID value for use in configuration cycles. The following table shows the bit to which each IDSEL signal is attached for segment A devices and the corresponding device description.

Table 13. Segment A Configuration IDs

IDSEL Value	Device
21	Intel® 82541PI LAN (NIC2)
17	PCI Slot 1(32b/33MHz)
16	PCI slot 2(32b/33MHz)

3.4.1.1.2 Segment A Arbitration

PCI segment A supports two PCI devices: the Intel® ICH9R and one PCI bus master (NIC). All PCI masters must arbitrate for PCI access using resources supplied by the Intel® ICH9R. The host bridge PCI interface (ICH9R) arbitration lines REQx* and GNTx* are a special case in that they are internal to the host bridge. Table 14 defines the arbitration connections.

Table 14. Segment A Arbitration Connections

Baseboard Signals	Device
PCI REQ_N5/GNT_N5	Intel® 82541PI LAN (NIC2)
PCI REQ_N1/GNT_N1	PCI Slot 1 (32-bit/33 MHz)
PCI REQ_N0/GNT_N0	PCI Slot 2 (32-bit/33 MHz)

3.4.1.2 PCI Interface for Video subsystem

The server board graphics subsystem is connected to the Intel® ICH9R with a PCI Express* x1 bus.

3.4.2 Interrupt Routing

The board interrupt architecture accommodates both PC-compatible PIC mode and APIC mode interrupts through the use of integrated I/O APICs in the Intel® ICH9R.

3.4.2.1 Legacy Interrupt Routing

For PC-compatible mode, the Intel® ICH9R provides two 82C59-compatible interrupt controllers. The two controllers are cascaded with interrupt levels 8 through 15 entering on level 2 of the primary interrupt controller (standard PC configuration). A single interrupt signal is presented to the processor, to which the processor responds for servicing. The Intel® ICH9R contains configuration registers that define which interrupt source logically maps to I/O APIC INTx pins.

The Intel® ICH9R handles both PCI and IRQ interrupts. The Intel® ICH9R translates these to the APIC bus. The numbers in Table 15 indicate the Intel® ICH9R PCI interrupt input pin to which the associated device interrupt (INTA, INTB, INTC, INTD, INTE, INTF, INTG, INTH for PCI bus and PXIRQ0, PXIRQ1, PXIRQ2, PXIRQ3 for PCI-X bus) is connected. The Intel® ICH9R I/O APIC exists on the I/O APIC bus with the processor.

Table 15. PCI AND PCI-X Interrupt Routing/Sharing

Interrupt	INT A	INT B	INT C	INT D
Intel® 82541PI LAN (NIC2)	PIRQB			
Integrated BMC	PIRQC			
PCI Slot 1 (PCI 32-bit/33 MHz)	PIRQG	PIRQF	PIRQE	PIRQH
PCI Slot 2 (PCI 32-bit/33 MHz)	PIRQF	PIRQG	PIRQH	PIRQE
PCI-X Slot 5 (64-bit/133 MHz) (LX board SKU only)	PXIRQ5	PXIRQ6	PXIRQ7	PXIRQ4
PCI-X Slot 6 (64-bit/133 MHz) (Riser, LX board SKU only)	PXIRQ0	PXIRQ1	PXIRQ2	PXIRQ3

3.4.2.2 APIC Interrupt Routing

For APIC mode, the server board interrupt architecture incorporates three Intel® I/O APIC devices to manage and broadcast interrupts to local APICs in each processor. The Intel® I/O APICs monitor each interrupt on each PCI device including PCI slots in addition to the ISA compatibility interrupts IRQ (0-15).

When an interrupt occurs, a message corresponding to the interrupt is sent across a three-wire serial interface to the local APICs. The APIC bus minimizes interrupt latency time for compatibility interrupt sources. The I/O APICs can also supply greater than 16 interrupt levels to the processor(s). This APIC bus consists of an APIC clock and two bi-directional data lines.

3.4.2.3 Legacy Interrupt Sources

Table 16 recommends the logical interrupt mapping of interrupt sources on the board. The actual interrupt map is defined using configuration registers in the Intel® ICH9R.

Table 16. Interrupt Definitions

ISA Interrupt	Description
INTR	Processor interrupt.
NMI	NMI to processor.
IRQ0	System timer
IRQ1	Keyboard interrupt.
IRQ2	Slave PIC
IRQ3	Serial port 1 interrupt from Super I/O* device, user-configurable.
IRQ4	Serial port 1 interrupt from Super I/O* device, user-configurable.
IRQ5	
IRQ6	Floppy disk.
IRQ7	Generic
IRQ8_L	Active low RTC interrupt.
IRQ9	SCI*
IRQ10	Generic
IRQ11	Generic
IRQ12	Mouse interrupt.
IRQ13	Floppy processor.
IRQ14	Compatibility IDE interrupt from primary channel IDE devices 0 and 1
IRQ15	Secondary IDE Cable
SMI*	System Management Interrupt: General purpose indicator sourced by the Intel® ICH9R to the processor

3.4.2.4 Serialized IRQ Support

The server board supports a serialized interrupt delivery mechanism. Serialized Interrupt Requests (SERIRQ) consist of a start frame, a minimum of 17 IRQ / data channels, and a stop frame. Any slave device in the quiet mode may initiate the start frame. While in the continuous mode, the start frame is initiated by the host controller.

3.4.3 PCI Error Handling

The PCI bus defines two error pins, PERR# and SERR#, for reporting PCI parity errors and system errors, respectively. In the case of PERR#, the PCI bus master has the option to retry the offending transaction or report it using SERR#. SERR# reports all other PCI-related errors. If enabled by the BIOS, SERR# is routed to NMI.

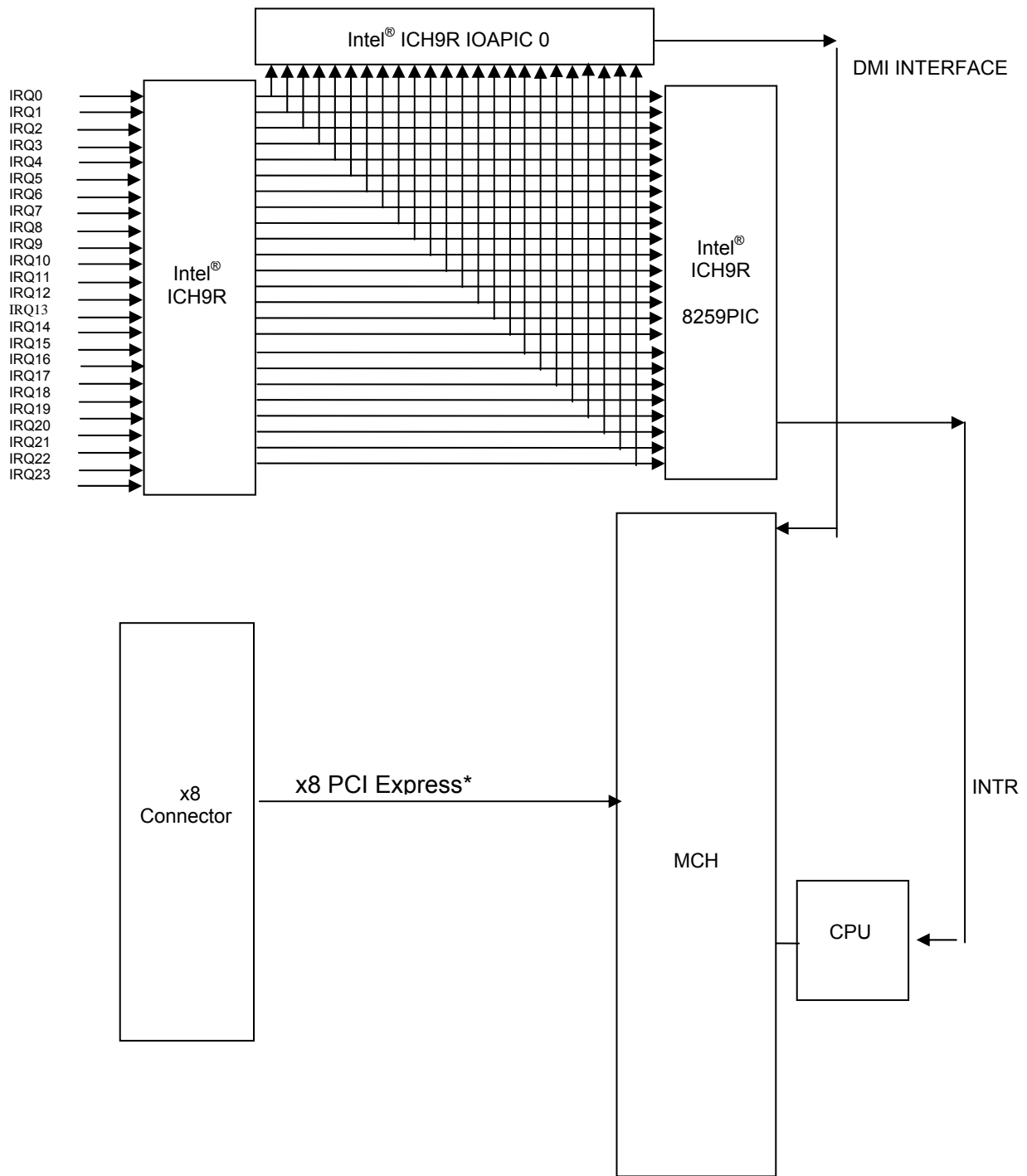

Figure 10. Interrupt Routing Diagram

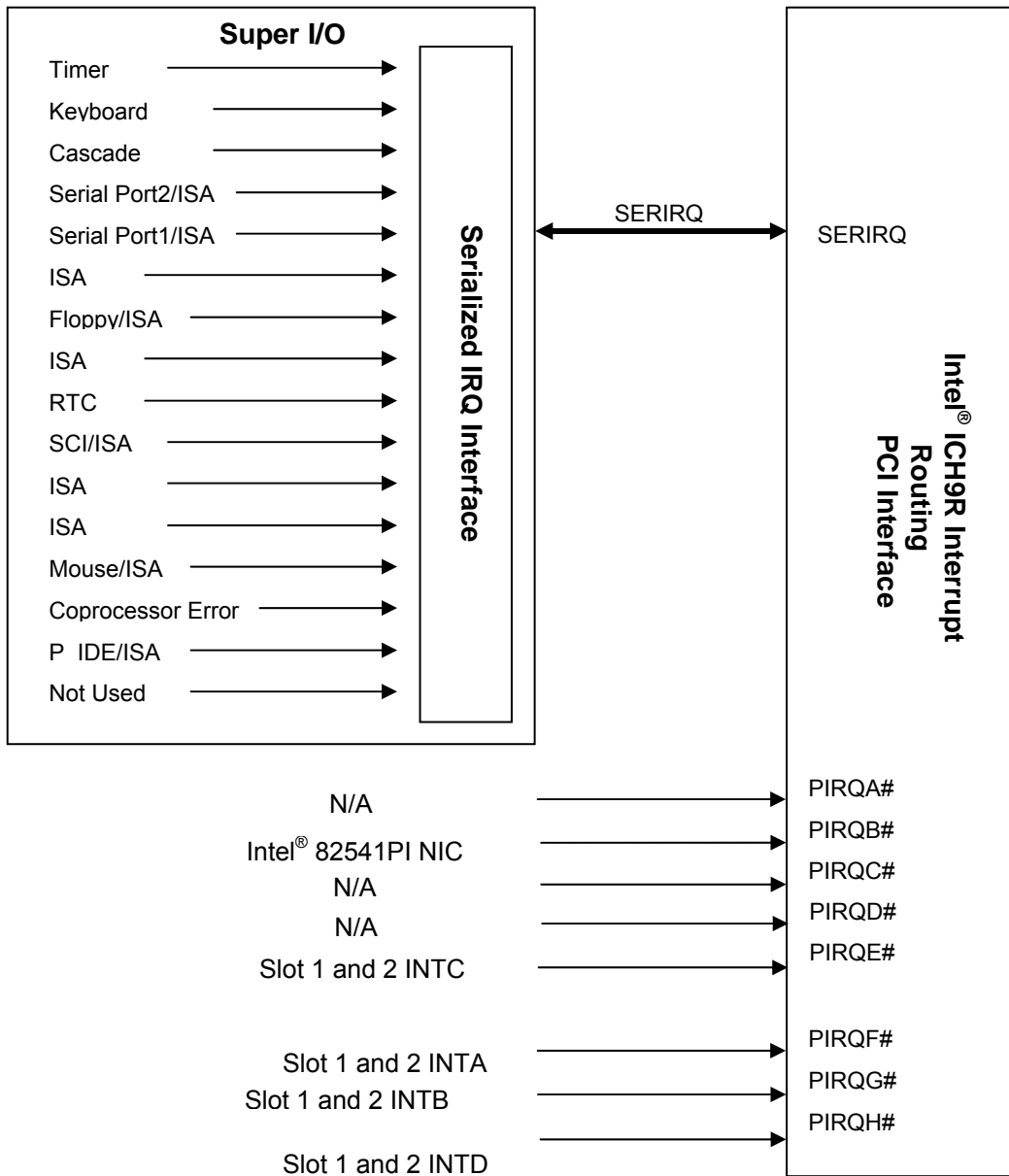

Figure 11. Intel® ICH9R Interrupt Routing Diagram

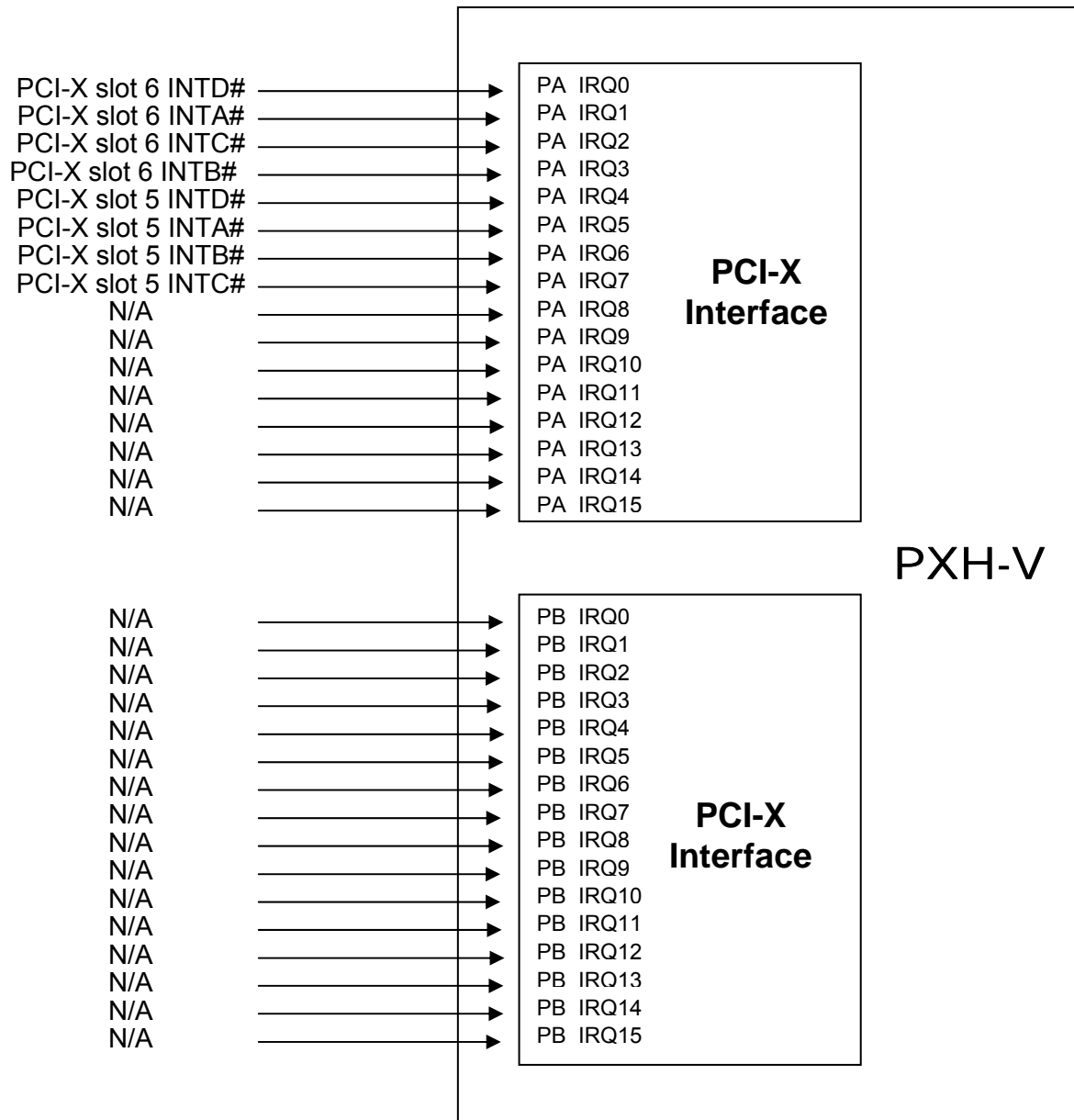

Figure 12. PXH-V Interrupt Routing Diagram

3.5 BMC Controller

The Integrated Baseboard Management Controller (Integrated BMC) is a highly integrated single-chip solution, integrating several devices typically found on servers. The Integrated BMC is mainly targeted at next generation servers and provides a highly-integrated server class product.

The Integrated BMC contains the following integrated subsystems and features.

Server Class Super I/O* functionality includes

- Keyboard style/BT interface for BMC support
- Two Fully Functional Serial Ports, compatible with the 16C550
- Serial IRQ Support
- SMI/SCI/PME Support
- ACPI Compliant
- Up to 16 Shared GPIO ports
- Programmable Wake-up Event Support
- Plug and Play Register Set
- Power Supply Control
- Watchdog timer compliant with Microsoft SHDG
- LPC to SPI bridge for system BIOS support
- Real Time Clock (RTC) module with external RTC interface

Baseboard Management Controller

- IPMI 2.0 Compliant
- Integrated 250 MHz 32-bit ARM9 processor
- Six I2C SMBus Modules with Master-Slave support
- Two independent 10/100 Ethernet Controllers with RMII support
- LPC Master interface for non-volatile code storage
- SPI Flash interface
- Three UART for ICMB support
- DDR2 16-bit up to 667 MHz memory interface
- 16 Mailbox Registers for communication between the host and the BMC
- Watchdog timer
- Three General Purpose Timers
- Dedicated Real Time Clock for BMC
- Up to 16 direct and 64 Serial GPIO ports
- Ability to maintain text and graphics controller history
- 12 10-bit Analog to Digital Converters
- Three Diode Inputs for Temperature measurements

- Eight Fan Tach Inputs
- Four Pulse Width Modulators (PWM)
- Chassis Intrusion Logic with battery backed general purpose register
- LED support with programmable blink rate control
- Programmable IO Port snooping, which can be used to snoop on Port 80h
- Unique Chip ID for each part, burned at the time of production testing
- Hardware 32-bit Random Number generator
- JTAG Master interface
- On-Chip Test Infrastructure for testing BMC firmware

Graphics Controller Subsystem

- Integrated Matrix Graphics Core
- 2D Hardware Graphics Acceleration
- DDR2 memory interface supports up to 128 Mbytes of memory
- Supports all display resolutions up to 1600 x 1200 16 bpp @ 75 Hz
- High speed Integrated 24-bit RAMDAC
- Single lane PCI Express* host interface

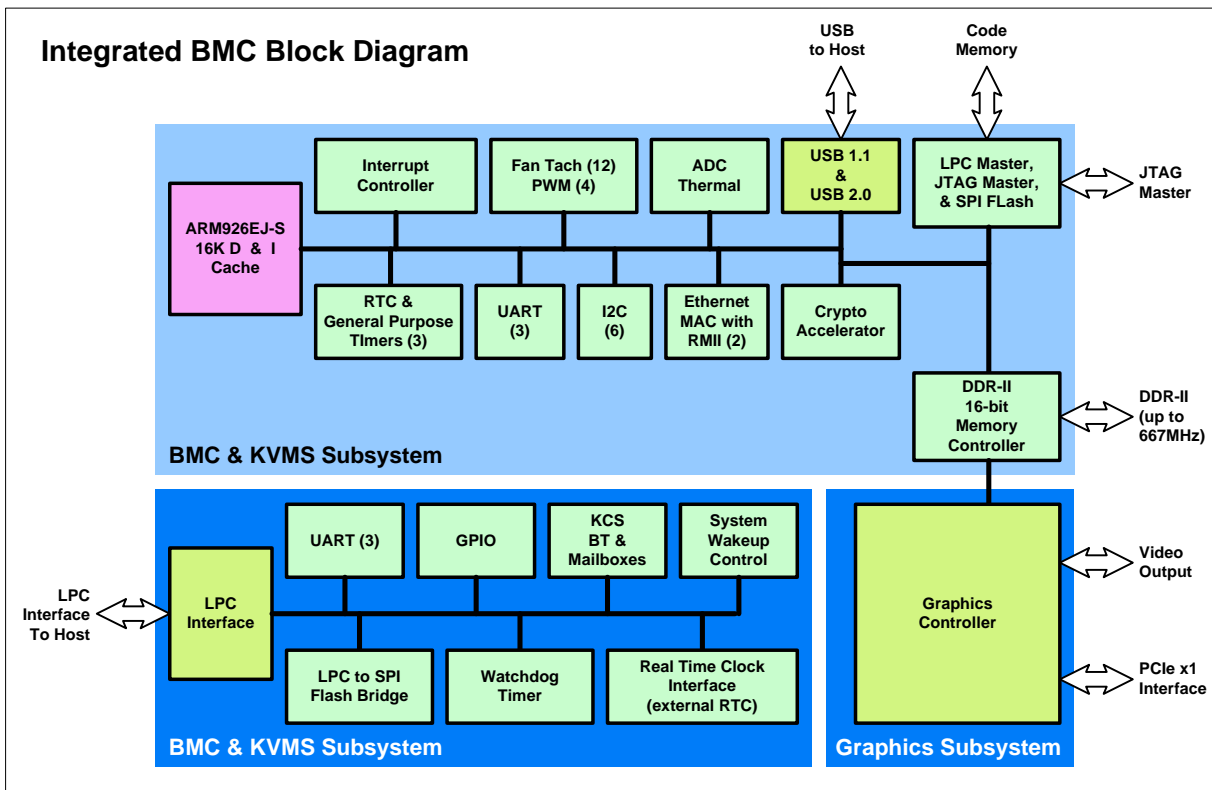

3.6 PCI Express* to PCI-X Bridge 6702PXH (PXH-V) (LX Board SKU Only)

The Intel® 6702PXH 64-bit PCI Hub is a peripheral chip that performs PCI bridging functions between the PCI Express* interface and the PCI bus. The Intel® 6702PXH 64-bit PCI Hub contains a single PCI bus interface that can be configured to operate in PCI (33 or 66 MHz) or PCI-X Mode 1 (66, 100, or 133 MHz).

The Intel® 6702PXH 64-bit PCI Hub further supports the new PCI Standard Hot-Plug Controller and Subsystem Specification, Revision 1.0. Each PCI interface contains an I/OxAPIC with 24 interrupts and a standard hot plug controller.

3.7 Clock Generator

A CK505 compliant Clock Synthesizer chip solution generates most of the required clocks on the Intel® Server Board S3200SH. The CK505 synthesizes and distributes a multitude of clock outputs at various frequencies, timings, and drive levels using a single parallel resonance 14.31818 MHz (50 ppm or less) crystal.

The CK505 clock generator supplies host clocks (at 200 MHz, 266 MHz, and 333 MHz), 100 MHz clocks, 48 MHz clocks, 33 MHz clocks, and 14 MHz clocks.

The CK505 has twelve SRC outputs targeted for PCI Express* applications at 100 MHz.

The CK505 is the main clock source for the entire system.

- The clock generator supports the following:
 - Differential host clock pairs for processor, MCH and XDP
 - Differential 100 MHz to ICH9 (DMI and SATA), MCH, XDP, and PCI Express* slots
 - 33 MHz clocks for ICH9, SIO, SM712, Port 80/81h and PCI32 slots
 - Single ended 48 MHz clock for the Intel® CH9 USB Controller
 - Single ended 14.318 MHz clocks shared between the ICH9 and SIO
 - Debug jumpers to manually select FSB/host clock frequency
- SMBus interface for spread spectrum support
- Option to retain register contents in PWRDWN# state

3.8 Super I/O

There is a Winbond* PC8374L super I/O located on the Intel® ICH9 LPC bus. This device uses the following features on the server board:

- LPC rev 1.1
- Floppy Disk Controller with a Digital Data Separator
- KB and Mouse Controller (KBC)
- ACPI 2.0b Compliant
- Sensor Path* Interface

3.9 GigE Controller 82541PI

The Intel® 82541 Gigabit Ethernet Controller is a single, compact component with integrated Gigabit Ethernet Media Access Controller (MAC) and Physical Layer (PHY) function. This device interfaces with the ICH9 using PCI 32 bit/33MHz. The server board uses this device along with the integrated ICH9 MAC and external 82566 PHY to provide two Gigabit Ethernet Ports.

The device has the following features:

- Uses PCI 32-bit/33 MHz PCI Interface
- IEEE802.3x compliant flow control support
- Integrated PHY for full 10/100/1000 Mbps full and half duplex operation
- On-board Microcontroller
- Wake-On LAN (WOL) Support
- IPMI support for server management

3.10 GigE PHY

The Intel® 82566 Gigabit Ethernet physical layer transceiver (PHY) is a single port device that supports the integrated ICH9 Media Access Controller (MAC) at 10 Mbps, 100 Mbps, or 1000 Mbps.

The PHY is interfaced to the ICH9 using a high-speed serial interface, the Gigabit LAN Connect Interface (GLCI). This interface operates using two capacitively coupled differential pairs; one transmit pair and one receive pair.

The PHY is also interfaced to the ICH9 using a lower frequency LAN Connect Interface (LCI). The LCI interface operates using eight single ended signals, one clock, three transmit, three receive, and one reset/sync.

The dual interface, GLCI/LCI allows the interfaces to be dynamically controlled based on the link speed. In gigabit Ethernet mode, the GLCI is used to transmit and receive data and the LCI is used for Management Data Input/Output (MDIO). For all other link speeds including no-link and power-down, the GLCI is electrically idle. In sleeping states S3 – S5, the gigabit Ethernet link is not supported.

3.11 On-Board Components

3.11.1 Video Support

The server board includes an integrated VGA graphics engine in Integrated BMC that supports standard VGA drivers with analog display capabilities. The graphics subsystem has 8 MB memory to support the onboard video controller. The baseboard provides a standard 15-pin VGA connector at the rear of the system, in the standard ATX I/O opening area. The video

controller is disabled by default in BIOS Setup when an off-board video adapter is detected in either the PCI Express* or PCI slots.

3.11.1.1 Video Modes

Table 17. Video Modes

2D Mode	Refresh Rate (Hz)	2D Video Mode Support			
		8 bpp	16 bpp	24 bpp	32 bpp
640x480	60, 72, 75, 90, 100	Supported	Supported	Supported	Supported
800x600	60, 70, 75, 90, 100	Supported	Supported	Supported	Supported
1024x768	60, 72, 75, 90, 100	Supported	Supported	Supported	Supported
1280x1024	43, 60	Supported	Supported	Supported	Supported
1280x1024	70, 72	Supported	–	Supported	Supported
1600x1200	60, 66	Supported	Supported	Supported	Supported
1600x1200	76, 85	Supported	Supported	Supported	–
3D Mode	Refresh Rate (Hz)	3D Video Mode Support with Z Buffer Enabled			
		8 bpp	16 bpp	24 bpp	32 bpp
640x480	60,72,75,90,100	Supported	Supported	Supported	Supported
800x600	60,70,75,90,100	Supported	Supported	Supported	Supported
1024x768	60,72,75,90,100	Supported	Supported	Supported	Supported
1280x1024	43,60,70,72	Supported	Supported	–	–
1600x1200	60,66,76,85	Supported	–	–	–
3D Mode	Refresh Rate (Hz)	3D Video Mode Support with Z Buffer Disabled			
		8 bpp	16 bpp	24 bpp	32 bpp
640x480	60,72,75,90,100	Supported	Supported	Supported	Supported
800x600	60,70,75,90,100	Supported	Supported	Supported	Supported
1024x768	60,72,75,90,100	Supported	Supported	Supported	Supported
1280x1024	43,60,70,72	Supported	Supported	Supported	–
1600x1200	60,66,76,85	Supported	Supported	–	–

3.12 Replacing the Back-Up Battery

The lithium battery on the server board powers the RTC for up to ten years in the absence of power. When the battery starts to weaken, it loses voltage, and the server settings stored in CMOS RAM in the RTC (for example, the date and time) may be wrong. For a list of approved devices, contact your customer service representative or dealer.



WARNING

Danger of explosion if battery is incorrectly replaced. Replace only with the same or equivalent type recommended by the equipment manufacturer. Discard used batteries according to manufacturer's instructions.



ADVARSEL!

Lithiumbatteri - Eksplosjonsfare ved feilagtig håndtering. Utskiftning må kun ske med batteri af samme fabrikat og type. Levér det brugte batteri tilbage til leverandøren.



ADVARSEL

Lithiumbatteri - Eksplosjonsfare. Ved utskifting benyttes kun batteri som anbefalt av apparatfabrikanten. Brukt batteri returneres apparatleverandøren.



WARNING

Explosionsfara vid felaktigt batteribyte. Använd samma batterityp eller en ekvivalent typ som rekommenderas av apparattillverkaren. Kassera använt batteri enligt fabrikantens instruktion.



VAROITUS

Paristo voi räjähtää, jos se on virheellisesti asennettu. Vaihda paristo ainoastaan laitevalmistajan suositteluun tyypin. Hävitä käytetty paristo valmistajan ohjeiden mukaisesti.

4. System BIOS

4.1 BIOS Identification String

The BIOS Identification string uniquely identifies the revision of the BIOS used on the server. The string is formatted as follows:

```
BoardFamilyID.OEMID.MajorRev.MinorRev.BuildID.BuildDateTime
```

Where:

- BoardFamilyID = String name for this board family
- OEMID = Three-character OEM ID. "86B" is used for Intel server boards
- MajorRev = Two decimal digits
- MinorRev = Two decimal digits
- BuildID = Four decimal digits
- BuildDateTime = Build date and time in MMDDYYYYHHMM format:

MM = Two-digit month

DD = Two-digit day of month

YYYY = Four-digit year

HH = Two-digit hour using 24-hour clock

MM = Two-digit minute

For example, Intel® Server Board S3200SH BIOS Build 3, generated on Jan 21, 2006 at 11:59 AM displays the following BIOS ID string in the POST diagnostic screen:

```
S3200.86B.01.00.0003.012120061159
```

The BIOS version in the Setup Utility displays as:

```
S3200.86B.01.00.0003
```

The BIOS ID identifies the BIOS image. It is not used to designate either the board ID Snow Hill or the BIOS phase (Alpha, Beta, and so forth). The board ID is available in the SMBIOS type 2 structure in which the phase of the BIOS can be determined by the release notes associated with the image. The Board ID is also available via setup.

Support for INT15H, Function DA8Ch (Get BIOSID) was removed. The BIOS ID must be read from the SMBIOS type 0 structure.

4.2 Logo / Diagnostic Window

The logo / diagnostic window may be in one of two forms, quiet boot mode and verbose mode. In quiet boot mode, a logo splash screen displays. In verbose mode, a system summary and diagnostic screen display. The default is to display the logo in quiet boot mode. If no logo is present in the flash ROM, or if quiet boot mode is disabled in the system configuration, the summary and diagnostic screen display.

The diagnostic screen consists of the following information

- BIOS ID
- Total memory detected (total size of all installed DIMMs)
- Processor information (Intel branded string, speed, and number of physical processors identified)
- Types of input devices (keyboard, mouse, and so forth) detected if plugged in (PS/2 and/or USB)

4.3 BIOS Setup Utility

The BIOS setup utility is a text-based utility that allows the user to configure the system and view current settings and environment information for the platform devices. The setup utility controls the platform's built-in devices.

The BIOS setup interface consists of a number of pages or screens. Each page contains information or links to other pages. The first page in Setup displays a list of general categories as links. These links lead to pages containing specific category's configuration.

The following sections describe the look and behavior for platform setup.

4.3.1 Operation

BIOS Setup has the following features:

- Localization. The BIOS is only available in English.
- BIOS Setup is functional via console redirection over various terminal emulation standards. This may limit some functionality for compatibility (for example, usage of colors or some keys or key sequences or support of pointing devices).

4.3.1.1 Setup Page Layout

The setup page layout is sectioned into functional areas. Each occupies a specific area of the screen and has dedicated functionality. Table 18 lists and describes each functional area.

Table 18. BIOS Setup Page Layout

Functional Area	Description
Title Bar	The title bar is located at the top of the screen and displays the title of the form (page) the user is currently viewing. It may also display navigational information.
Setup Item List	The Setup Item List is a set of controllable and informational items. Each item in the list occupies the left and center columns in the middle of the screen. The left column, the "Setup Item", is the subject of the item. The middle column, the "Option", contains an informational value or choices of the subject. A Setup Item may also be a hyperlink used to navigate form sets (pages). When it is a hyperlink, a Setup Item only occupies the "Setup Item" column.
Item Specific Help Area	The Item Specific Help area is located on the right side of the screen and contains help text for the highlighted Setup Item. Help information includes the meaning and usage of the item, allowable values, effects of the options, and so forth.
Keyboard Command Bar	The Keyboard Command Bar is located at the bottom right of the screen and continuously displays help for keyboard special keys and navigation keys. The keyboard command bar is context-sensitive—it displays keys relevant to current page and mode.
Status Bar	The Status Bar occupies the bottom line of the screen. This line displays the BIOS ID

4.3.1.2 Entering BIOS Setup

You start the BIOS Setup by pressing <F2> during boot time when the OEM (Original Equipment Manufacturer) or Intel logo displays.

When Quiet Boot is disabled, the message "press <F2> to enter setup" displays on the diagnostics screen.

4.3.1.3 Keyboard Commands

The bottom right portion of the Setup screen provides a list of commands used to navigate through the Setup utility. These commands are displayed at all times.

Each setup menu page contains a number of features. Except those used for informative purposes, each feature is associated with a value field. This field contains user-selectable parameters. Depending on the security option chosen and in effect by the password, a menu feature's value may or may not be changeable. If a value is non-changeable, the feature's value field is inaccessible. It displays as "grayed out." Table 19 lists these options.

Table 19. BIOS Setup: Keyboard Command Bar

Key	Option	Description
<Enter>	Execute Command	The <Enter> key activates sub-menus when the selected feature is a sub-menu, or displays a pick list if a selected option has a value field, or selects a sub-field for multi-valued features like time and date. If a pick list is displayed, the <Enter> key selects the currently highlighted item, undoes the pick list, and returns the focus to the parent menu.
<Esc>	Exit	The <Esc> key provides a mechanism for backing out of any field. This key undoes the pressing of the Enter key. When the <Esc> key is pressed while editing any field or selecting features of a menu, the parent menu is re-entered. When the <Esc> key is pressed in any sub-menu, the parent menu is re-entered. When the <Esc> key is pressed in any major menu, the exit confirmation window displays and the user is asked whether changes can be discarded. If “No” is selected and the <Enter> key is pressed, or if the <Esc> key is pressed, the user is returned to where he/she was before <Esc> was pressed, without affecting any existing settings. If “Yes” is selected and the <Enter> key is pressed, setup is exited and the BIOS returns to the main System Options Menu screen.
<input type="checkbox"/>	Select Item	Use the up arrow to select the previous value in a pick list, or the previous option in a menu item's option list. Activate the selected item by pressing the <Enter> key.
<input type="checkbox"/>	Select Item	The down arrow is used to select the next value in a menu item's option list, or a value field's pick list. Activate the selected item by pressing the <Enter> key.
<input type="checkbox"/>	Select Menu	Use the left and right arrow keys to move between the major menu pages. The keys have no effect if a sub-menu or pick list displays.
<Tab>	Select Field	Use the <Tab> key to move between fields. For example, use <Tab> to move from hours to minutes in the time item in the main menu.
-	Change Value	Use the minus key on the keypad to change the value of the current item to the previous value. This key scrolls through the values in the associated pick list without displaying the full list.
+	Change Value	Use the plus key on the keypad to change the value of the current menu item to the next value. This key scrolls through the values in the associated pick list without displaying the full list. On 106-key Japanese keyboards, the plus key has a different scan code than the plus key on the other keyboard, but will have the same effect.
<F9>	Setup Defaults	Pressing <F9> causes the following message to display: <div style="border: 1px solid black; padding: 5px; text-align: center;">Load Optimized defaults? (Y/N)</div> If the <Y> key is pressed, all Setup fields are set to their default values. If the <N> key is pressed, or if the <Esc> key is pressed, the user is returned to where they were before <F9> was pressed without affecting any existing field values
<F10>	Save and Exit	Pressing <F10> causes the following message to display: <div style="border: 1px solid black; padding: 5px; text-align: center;">Save Configuration and Reset? (Y/N)</div> If the <Y> key is pressed, all changes are saved and Setup is exited. If the <N> key is pressed, or the <Esc> key is pressed, the user is returned to where they were before <F10> was pressed without affecting any existing values.

4.3.1.4 Menu Selection Bar

The Menu Selection Bar is located at the top of the screen. It displays the major menu selections available to the user.

4.3.2 Server Platform Setup Screens

The following sections describe the screens available for the configuration of a server platform. The tables in these sections describe the contents of each screen. These tables follow these guidelines:

- The BIOS Setup screens display the text and values in the Setup Item, Options, and Help columns in the tables.
- Bold text in the Options column of the tables indicates default values. These values do not display in bold on the setup screen. The bold text in this document serves as a reference point.
- The Comments column provides additional information where it may be helpful. This information does not display in the BIOS Setup screens.
- Information in the screen shots enclosed in brackets (< >) indicates text that varies, depending on the option(s) installed. For example, <Current Date> is replaced by the actual current date.
- Information enclosed in square brackets ([]) in the tables indicates areas where the user must type in text instead of selecting from a list of provided options.

4.3.2.1 Main Screen

Unless an error occurred, the Main screen is the first screen that displays during the BIOS Setup. If an error occurred, the Error Manager screen displays instead.

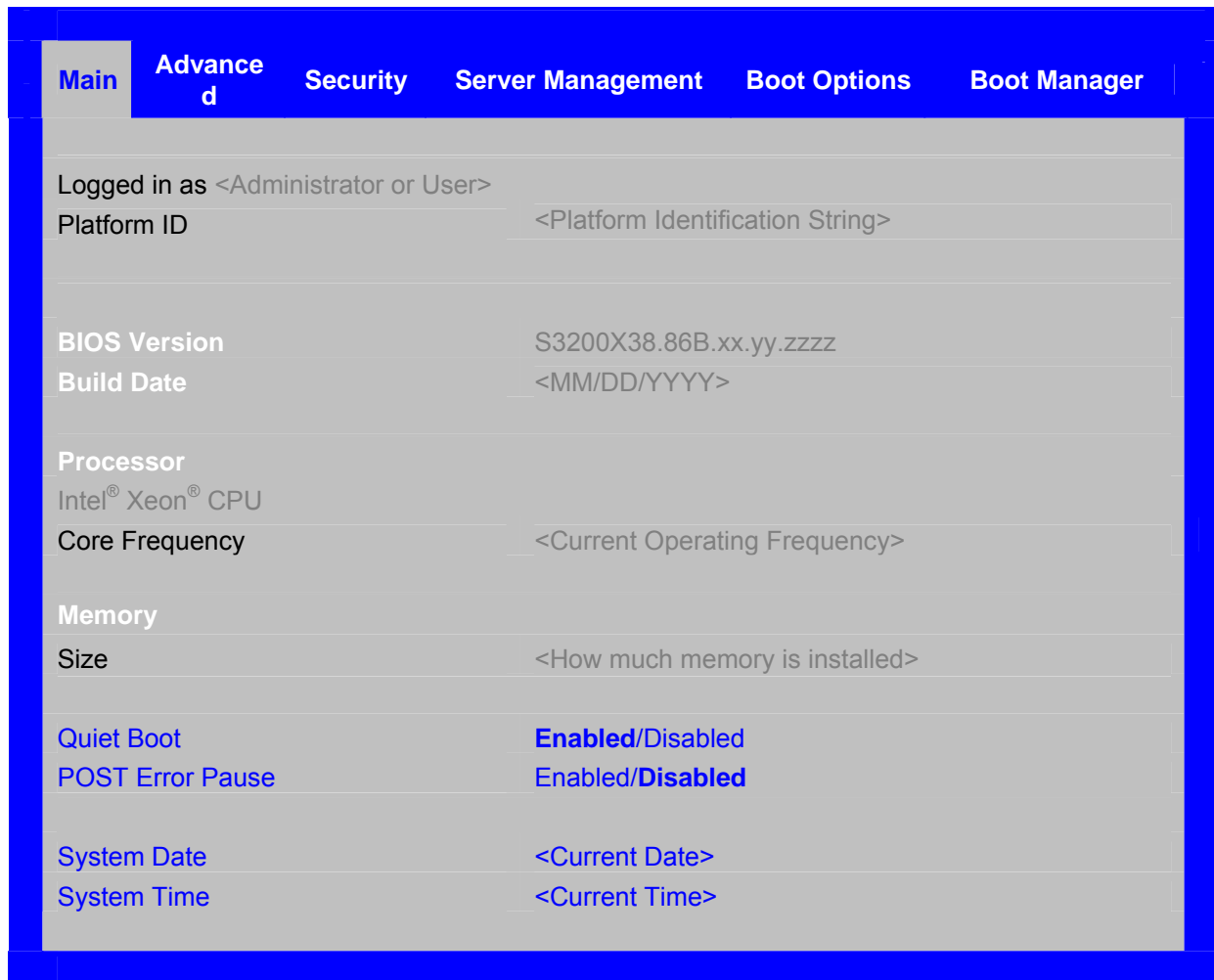

Figure 13. Setup Utility — Main Screen Display

Table 20. Setup Utility — Main Screen Fields

Setup Item	Options	Help Text	Comments
Logged in as			Information only. Displays password level that setup is running in, which is either Administrator or User. If a password is not set, the default mode is Administrator.
Platform ID			Information only. Displays the Platform ID.
System BIOS			
Version			Information only. Displays the current BIOS version. xx = major version yy = minor version zzzz = build number
Build Date			Information only. Displays the current BIOS build date.
Processor			
<ID string from the Processor>			Information only. Displays the Intel processor name and the CPU speed. This information is retrieved from the processor.
Core Frequency			Information only. Displays the current speed of the boot processor in GHz or MHz.
Count			Information only. Number of physical processors detected.
Memory			
Size			Information only. Displays the total physical memory installed in the system in MB or GB. The term physical memory indicates the total memory discovered in the form of installed DIMMs.
Quiet Boot	Enabled Disabled	[Enabled] – Display the logo screen during POST. [Disabled] – Display the diagnostic screen during POST.	
POST Error Pause	Enabled Disabled	[Enabled] – Go to the Error Manager for critical POST errors. [Disabled] – Attempt to boot and do not go to the Error Manager for critical POST errors.	The POST error pause takes the system to the error manager to review the errors when Major errors occur. Minor and Fatal error displays are not affected by this setting. See Section 7.3.3 for more information.

Setup Item	Options	Help Text	Comments
System Date	[Day of week MM/DD/YYYY]	System Date has configurable fields for Month, Day, and Year. Use [Enter] or [Tab] key to select the next field. Use [+] or [-] key to modify the selected field.	
System Time	[HH:MM:SS]	System Time has configurable fields for Hours, Minutes, and Seconds. Hours are in 24-hour format. Use [Enter] or [Tab] key to select the next field. Use [+] or [-] key to modify the selected field.	

4.3.2.2 Advanced Screen

The Advanced screen provides an access point to configure several options such as processor, memory, SATA controller, and so forth. On this screen, the user selects the option they want to configure. Configurations are performed on a separate screen associated with the selected option—not directly on the Advanced screen.

To access this screen from the Main screen, press the right arrow until the Advanced screen is selected.

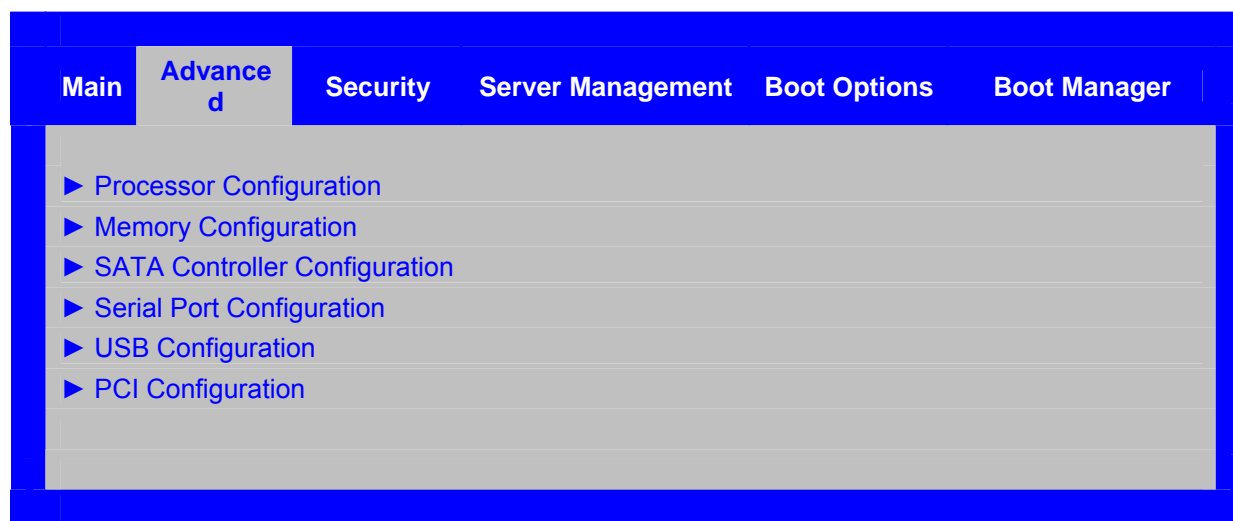

Figure 14. Setup Utility — Advanced Screen Display

Table 21. Setup Utility — Advanced Screen Display Fields

Setup Item	Options	Help Text
Processor Configuration		View/Configure processor information and settings.
Memory Configuration		View/Configure memory information and settings.
SATA Controller Configuration		View/Configure SATA Controller information and settings.
Serial Port Configuration		View/Configure serial port information and settings.
USB Configuration		View/Configure USB information and settings.
PCI Configuration		View/Configure PCI information and settings.

4.3.2.2.1 Processor Screen

The Processor screen provides a place for the user to view the processor core frequency, system bus frequency, and enable or disable several processor options. The user can also select an option to view information about a specific processor.

To access this screen from the Main screen, select Advanced | Processor.

**Figure 15. Setup Utility — Processor Configuration Screen Display**

Table 22. Setup Utility — Processor Configuration Screen Fields

Setup Item	Options	Help Text	Comments
Processor Family			Information only. Identifies the processor family or generation.
Core Frequency			Information only. Frequency at which processors currently run.
Maximum Frequency			Information only. Maximum frequency the processor core supports.
System Bus Frequency			Information only. Current frequency of the processor FSB.
L2 Cache RAM			Information only. Size of the processor L2 cache.
Processor Stepping			Information only. Stepping number of the processor.
CPUID Register			Information only. CPUID register value identifies details about the processor family, model, and stepping.
Enhanced Intel SpeedStep® Technology	Enabled Disabled	Enhanced Intel SpeedStep® Technology allows the system to dynamically adjust processor voltage and core frequency, which can result in decreased average power consumption and decreased average heat production. Contact your OS vendor regarding OS support of this feature.	
Core Multi-processing	Enabled Disabled	Core Multi-processing sets the state of logical processor cores in a package. [Disabled] sets only logical processor core 0 as enabled in each processor package. Note: If disabled, Hyper-Threading Technology is automatically disabled."	
Intel® Virtualization Technology	Enabled Disabled	Intel® Virtualization Technology allows a platform to run multiple operating systems and applications in independent partitions. Note: For a change to this option to take effect, you must power off and then power back on the system.	
Execute Disable Bit	Enabled Disabled	Execute Disable Bit can help prevent certain classes of malicious buffer overflow attacks. Contact your OS vendor regarding OS support of this feature.	

4.3.2.2.2 Memory Screen

The Memory screen provides a place for the user to view details about installed system memory DIMMs. On this screen, the user can select an option to open the Configure Memory RAS and Performance screen.

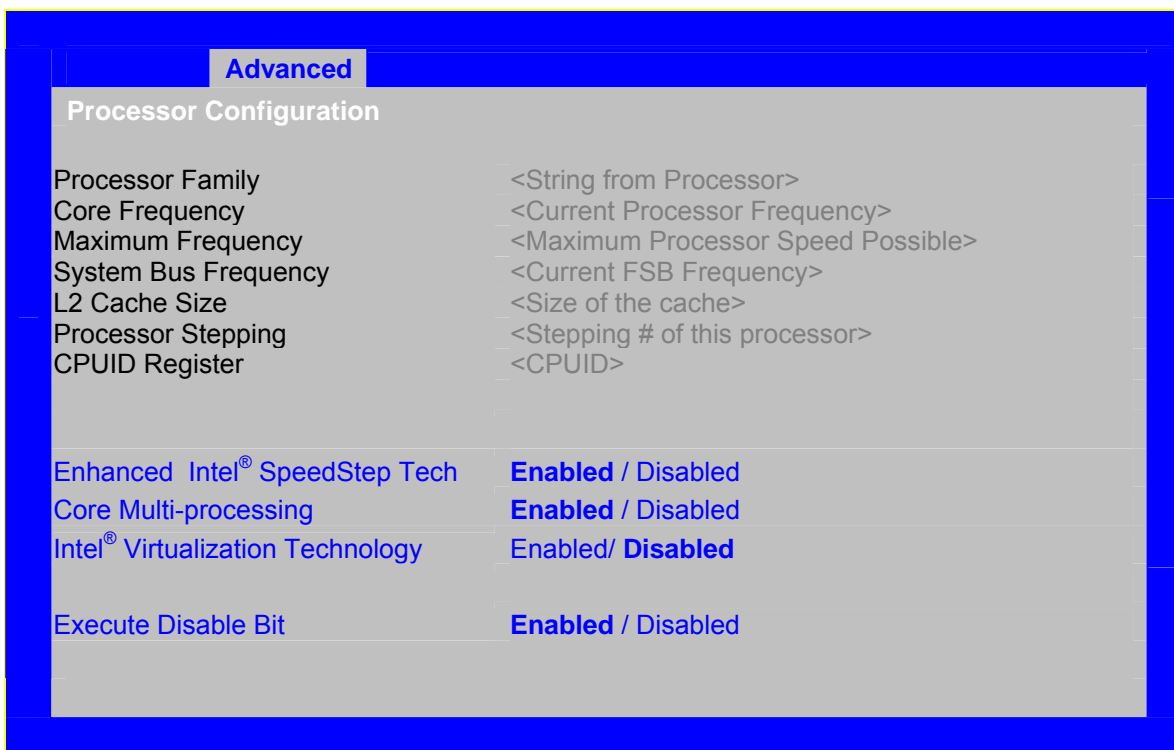
To access this screen from the Main screen, select Advanced | Memory.

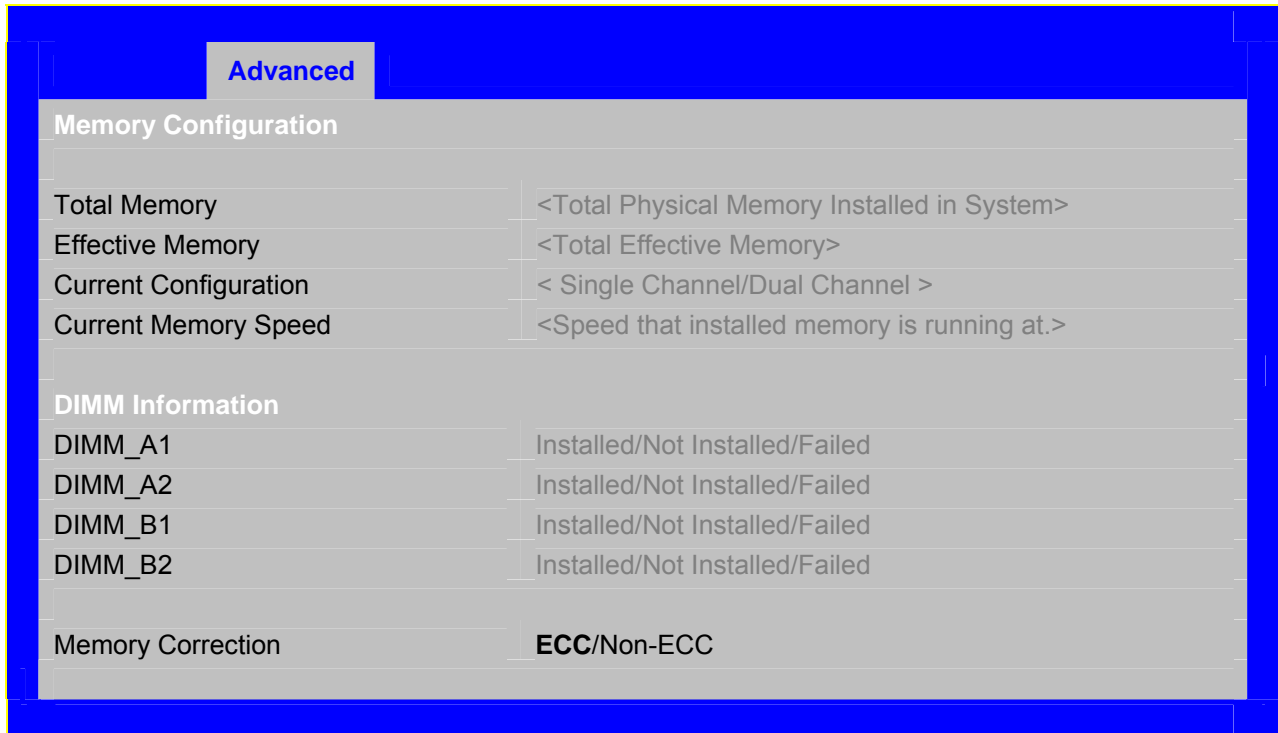

Figure 16. Setup Utility — Memory Configuration Screen Display

Table 23. Setup Utility — Memory Configuration Screen Fields

Setup Item	Options	Comments
Total Memory		Information only. The amount of memory (in MB or GB) available in the system in the form of installed DIMMs
Effective Memory		Information only. The amount of memory available to the operating system in MB or GB. The Effective Memory is the difference between Total Physical Memory and the sum of all memory reserved for internal usage. This difference includes the sum of all DIMMs that failed Memory Test during POST.

Setup Item	Options	Comments
Current Configuration		<p>Information only. Displays one of the following:</p> <ul style="list-style-type: none"> <input type="checkbox"/> Dual Channel: System memory is configured for optimal performance and efficiency. <input type="checkbox"/> Single Channel: System memory is functioning in a special, reduced efficiency mode.
Current Memory Speed		<p>Information only. Displays the speed the memory is running at.</p>
DIMM_#		<p>Displays the state of each DIMM socket present on the board. Each DIMM socket field reflects one of the following possible states:</p> <p>Installed: There is a DIMM installed in this slot.</p> <p>Not Installed: There is no DIMM installed in this slot.</p> <p>Failed: The DIMM installed in this slot is faulty / malfunctioning.</p>
Memory Correction	ECC Non-ECC	

4.3.2.2.3 SATA Controller Screen

The ATA Controller screen provides fields to configure SATA hard disk drives. It also provides information on installed hard disk drives.

To access this screen from the Main screen, select Advanced | SATA Controller.



Figure 17. Setup Utility — ATA Controller Configuration Screen Display

Table 24. Setup Utility — ATA Controller Configuration Screen Fields

Setup Item	Options	Help Text	Comments
Onboard SATA Controller	Enabled Disabled	Onboard Serial ATA (SATA) controller.	When enabled, the SATA controller can be configured in RAID Mode.
Configure SATA as	SATA RAID IDE	[AHCI] – The SATA drives will be set to work as independent SATA drives [RAID] - SATA controller will be in RAID mode and the Intel® RAID for Serial ATA option ROM will execute. [IDE] – The SATA drives will be set to work as independent SATA drives	When RAID is selected, no SATA drive information is displayed.
SATA Port 0	< Not Installed / Drive information >		Information only: Unavailable when RAID Mode is enabled.
SATA Port 1	< Not Installed / Drive information >		Information only: This field is unavailable when RAID Mode is enabled.
SATA Port 2	< Not Installed / Drive information >		Information only: This field is unavailable when RAID Mode is enabled.
SATA Port 3	< Not Installed / Drive information >		Information only: This field is unavailable when RAID Mode is enabled.
SATA Port 4	< Not Installed / Drive information >		Information only: This field is only available when AHCI Mode is enabled.
SATA Port 5	< Not Installed / Drive information >		Information only: This field is only available when AHCI Mode is enabled.

4.3.2.2.4 Serial Ports Screen

The Serial Ports screen provides fields to configure the Serial A [COM 1] and Serial B [COM2].

To access this screen from the Main screen, select Advanced | Serial Port.

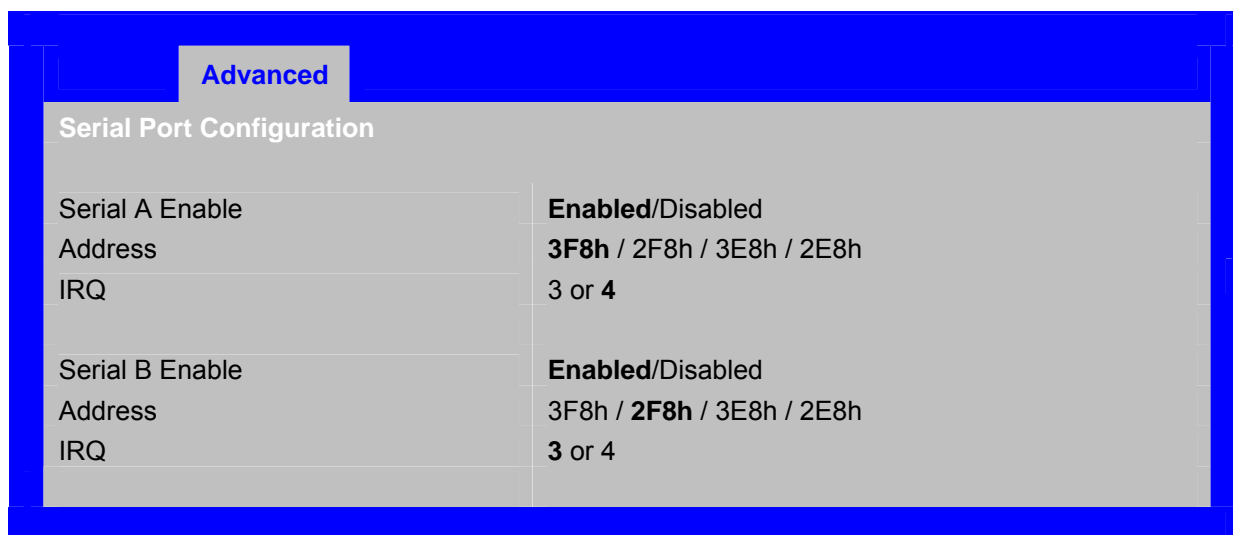

Figure 18. Setup Utility — Serial Port Configuration Screen Display

Table 25. Setup Utility — Serial Ports Configuration Screen Fields

Setup Item	Options	Help Text
Serial A Enable	Enabled Disabled	Enable or Disable Serial port A.
Address	3F8h 2F8h 3E8h 2E8h	Select Serial port A base I/O address.
IRQ	3 4	Select Serial port A base interrupt request (IRQ) line.
Serial B Enable	Enabled Disabled	Enable or Disable Serial port B.
Address	3F8h 2F8h 3E8h 2E8h	Select Serial port B base I/O address.
IRQ	3 4	Select Serial port B base interrupt request (IRQ) line.

4.3.2.2.5 USB Configuration Screen

The USB Configuration screen provides fields to configure the USB controller options.

To access this screen from the Main screen, select Advanced | USB Configuration.

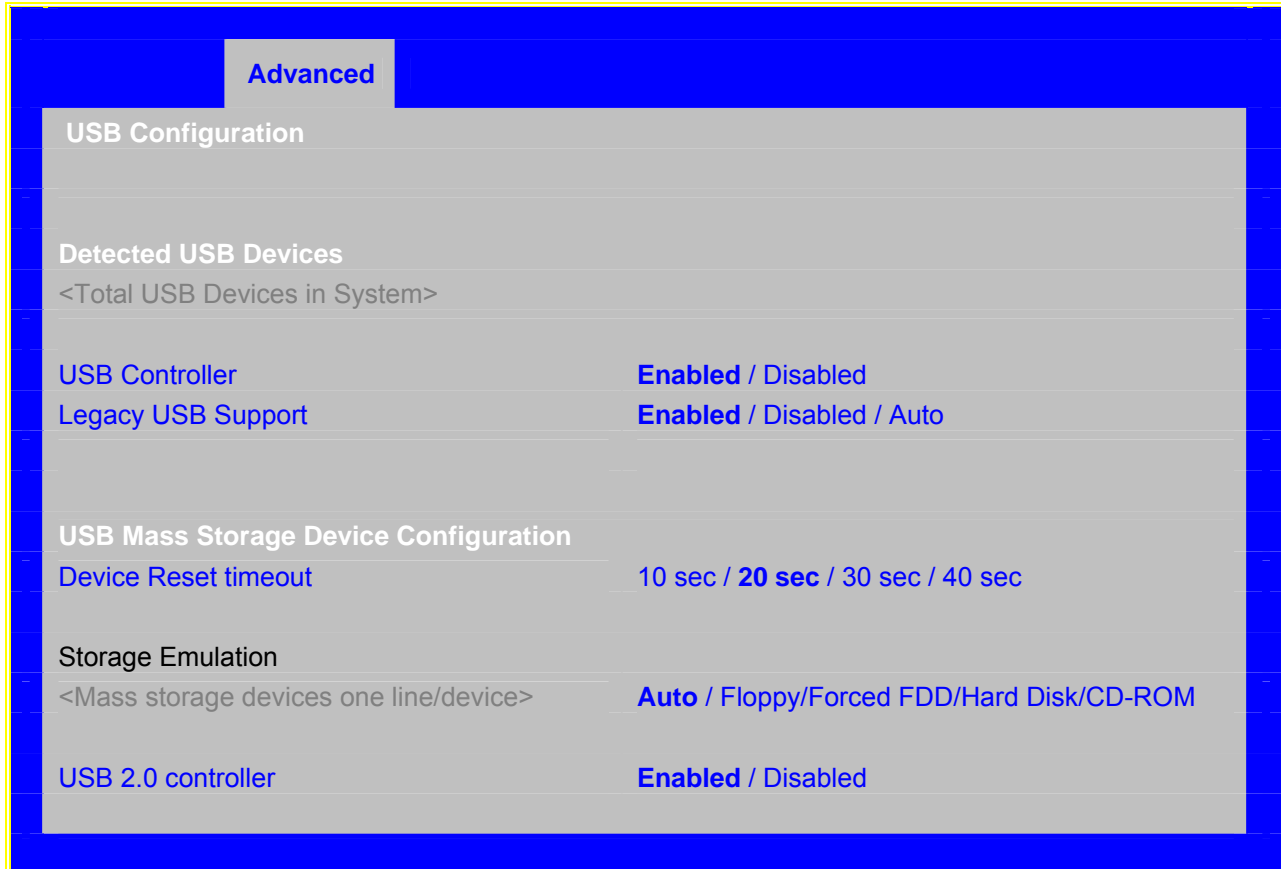

Figure 19. Setup Utility — USB Controller Configuration Screen Display

Table 26. Setup Utility — USB Controller Configuration Screen Fields

Setup Item	Options	Help Text	Comments
Detected USB Devices			Information only: Shows number of connected USB devices
USB Controller	Enabled Disabled	[Enabled] - All onboard USB controllers will be turned on and accessible by the OS. [Disabled] - All onboard USB controllers will be turned off and inaccessible by the OS.	
Legacy USB Support	Enabled Disabled Auto	PS/2 emulation for USB keyboard and USB mouse devices. [Auto] - Legacy USB support will be enabled if a USB device is attached.	
Device Reset timeout	10 sec 20 sec 30 sec 40 sec	USB Mass storage device Start Unit command timeout.	
Storage Emulation			Header for next line.
One line for each mass storage device in system	Auto Floppy Forced FDD Hard Disk CD-ROM	[Auto] - USB devices less than 530MB will be emulated as floppy. [Forced FDD] - HDD formatted drive will be emulated as FDD (e.g., ZIP drive).	This setup screen can show a maximum of eight devices on this screen. If more than eight devices are installed in the system, the “USB Devices Enabled” displays the correct count, but only the first eight devices can display here.
USB 2.0 controller	Enabled Disabled	Onboard USB ports will be enabled to support USB 2.0 mode. Contact your OS vendor regarding OS support of this feature.	

4.3.2.2.6 PCI Screen

The PCI Screen provides fields to configure PCI add-in cards, the onboard NIC controllers, and video options.

To access this screen from the Main screen, select Advanced | PCI.

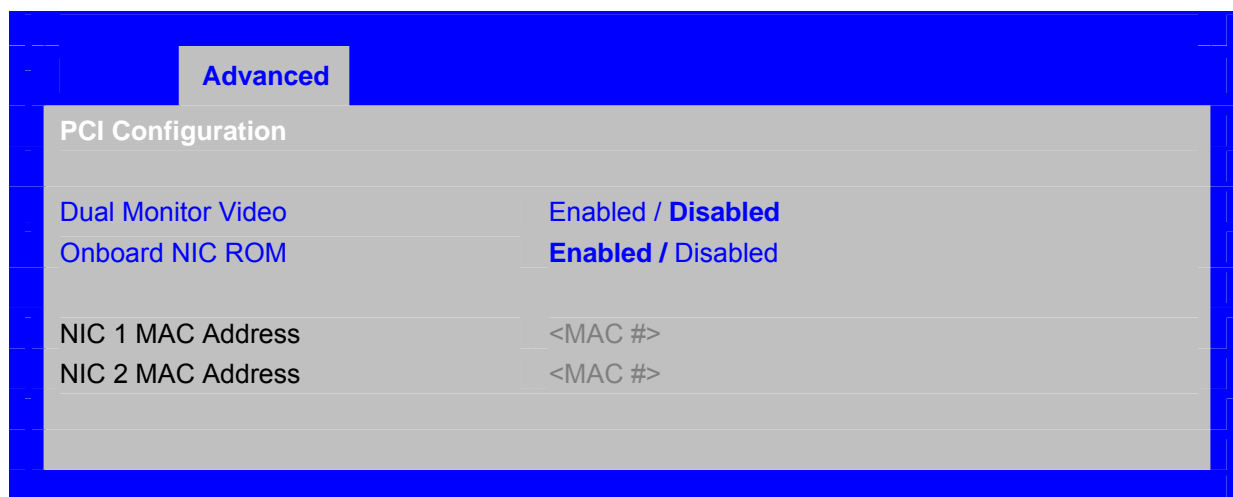

Figure 20. Setup Utility — PCI Configuration Screen Display

Table 27. Setup Utility — PCI Configuration Screen Fields

Setup Item	Options	Help Text	Comments
Dual Monitor Video	Enabled Disabled	Both the onboard video controller and an add-in video adapter will be enabled for system video. The onboard video controller will be the primary video device.	
Onboard NIC ROM	Enabled Disabled	Load the embedded option ROM for the onboard network controllers. Warning: If [Disabled] is selected, NIC1 and NIC2 cannot be used to boot or wake the system.	
NIC 1 MAC Address	No entry allowed		Information only. 12 hex digits of the MAC address.
NIC 2 MAC Address	No entry allowed		Information only. 12 hex digits of the MAC address.

4.3.2.3 Security Screen

The Security screen provides fields to enable and set the user and administrative password and to lock out the front panel buttons so they cannot be used.

To access this screen from the Main screen, select the Security option.

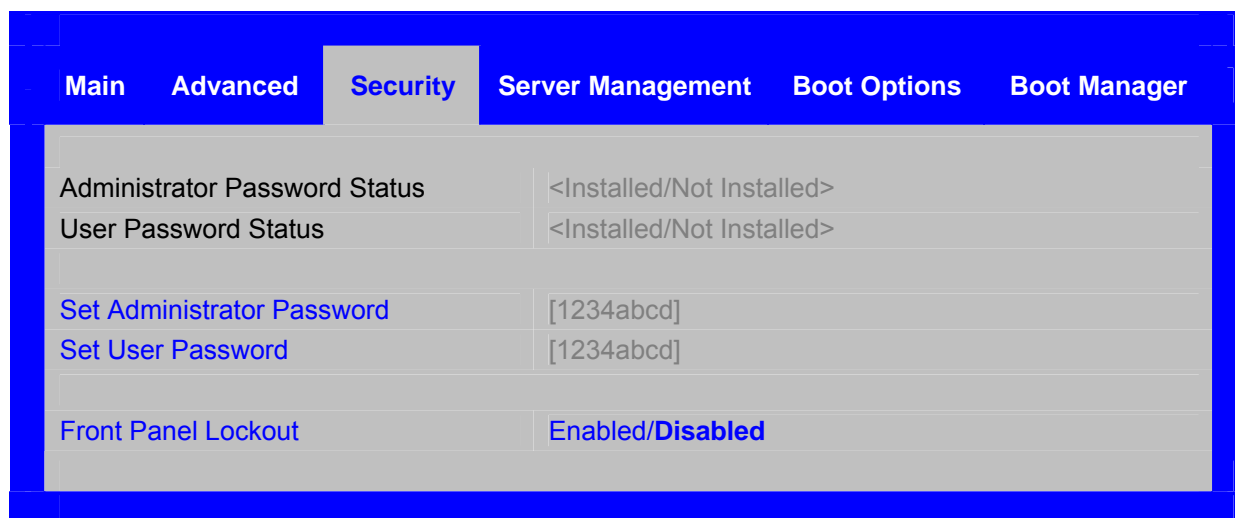

Figure 21. Setup Utility — Security Configuration Screen Display

Table 28. Setup Utility — Security Configuration Screen Fields

Setup Item	Options	Help Text	Comments
Administrator Password Status	<Installed Not Installed>		Information only. Indicates the status of the administrator password.
User Password Status	<Installed Not Installed>		Information only. Indicates the status of the user password.
Set Administrator Password	[123abcd]	Administrator password is used to control change access in BIOS Setup Utility. Only alphanumeric characters can be used. Maximum length is 7 characters. It is not case sensitive. Note: Administrator password must be set in order to use the user account.	This option only controls access to setup. Administrator has full access to all setup items. Clearing the Admin password also clears the user password.
Set User Password	[123abcd]	User password is used to control entry access to BIOS Setup Utility. Only alphanumeric characters can be used. Maximum length is 7 characters. It is not case sensitive. Note: Removing the administrator password will also automatically remove the user password.	Available only if the Administrator Password is installed. This option only protects setup. User password only has limited access to setup items.
Front Panel Lockout	Enabled Disabled	Locks the power button and reset button on the system's front panel. If [Enabled] is selected, power and reset must be controlled via a system management interface.	

4.3.2.4 Server Management Screen

The Server Management screen provides fields to configure several server management features such as enabling FRB-2, clearing the system event log, and so forth. It also provides an access point to the screens for configuring console redirection and displaying system information.

To access this screen from the Main screen, select the Server Management option.

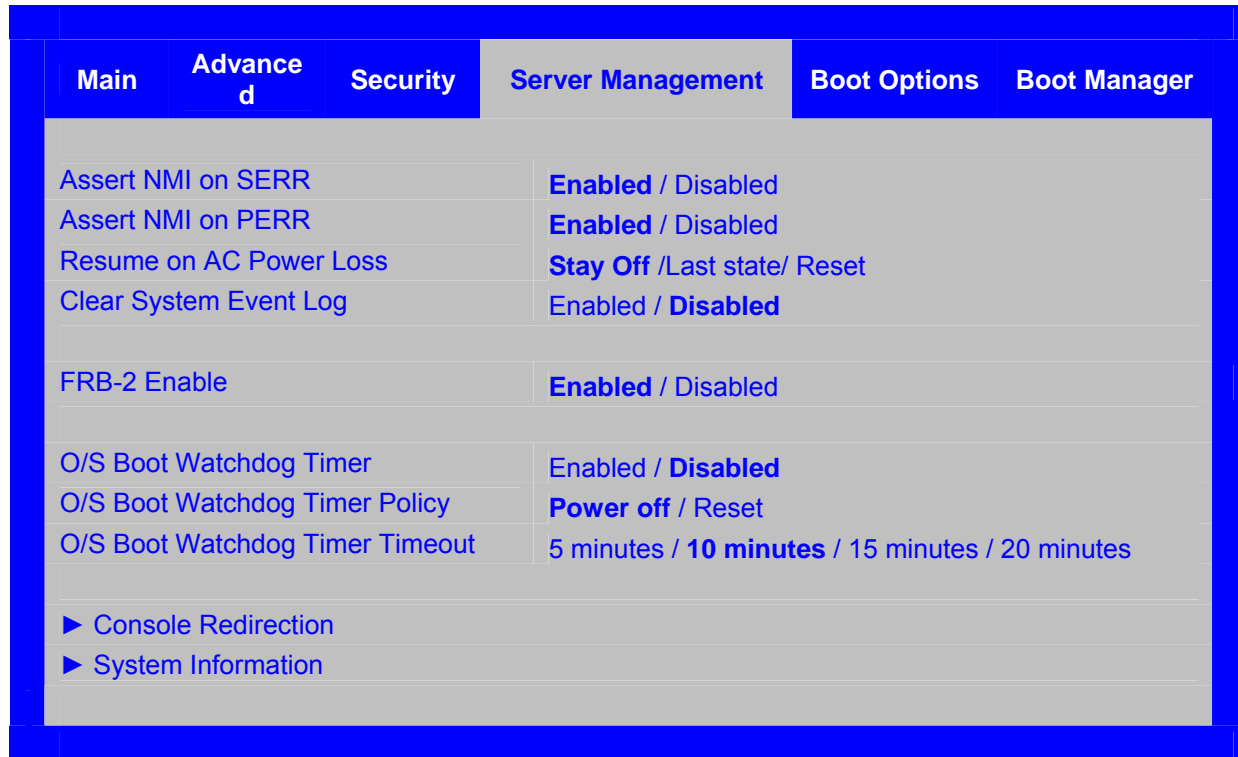

Figure 22. Setup Utility — Server Management Configuration Screen Display

Table 29. Setup Utility — Server Management Configuration Screen Fields

Setup Item	Options	Help Text
Assert NMI on SERR	Enabled Disabled	On SERR, generate an NMI and log an error. Note: [Enabled] must be selected for the Assert NMI on PERR setup option to be visible.
Assert NMI on PERR	Enabled Disabled	On PERR, generate an NMI and log an error. Note: This option is only active if the Assert NMI on SERR option is [Enabled] selected."
Resume on AC Power Loss	Stay Off Last state Reset	System action to take on AC power loss recovery. [Stay Off] - System stays off. [Last State] - System returns to the same state before the AC power loss. [Reset] - System powers on.

Setup Item	Options	Help Text
Clear System Event Log	Enabled Disabled	Clears the System Event Log. All current entries will be lost. Note: This option will be reset to [Disabled] after a reboot.
FRB-2 Enable	Enabled Disabled	Fault Resilient Boot (FRB). BIOS programs the BMC watchdog timer for approximately 6 minutes. If BIOS does not complete POST before the timer expires, the BMC will reset the system.
O/S Boot Watchdog Timer	Enabled Disabled	BIOS programs the watchdog timer with the timeout value selected. If the OS does not complete booting before the timer expires, the BMC will reset the system and an error will be logged. Requires OS support or Intel Management Software.
O/S Boot Watchdog Timer Policy	Power Off Reset	If the OS watchdog timer is enabled, this is the system action taken if the watchdog timer expires. [Reset] - System performs a reset. [Power Off] - System powers off.
O/S Boot Watchdog Timer Timeout	5 minutes 10 minutes 15 minutes 20 minutes	If the OS watchdog timer is enabled, this is the timeout value BIOS will use to configure the watchdog timer.
Console Redirection		View/Configure console redirection information and settings.
System Information		View system information

4.3.2.4.1 Console Redirection Screen

The Console Redirection screen provides a way to enable or disable console redirection and to configure the connection options for this feature.

To access this screen from the Main screen, select Server Management. Select the Console Redirection option from the Server Management screen.

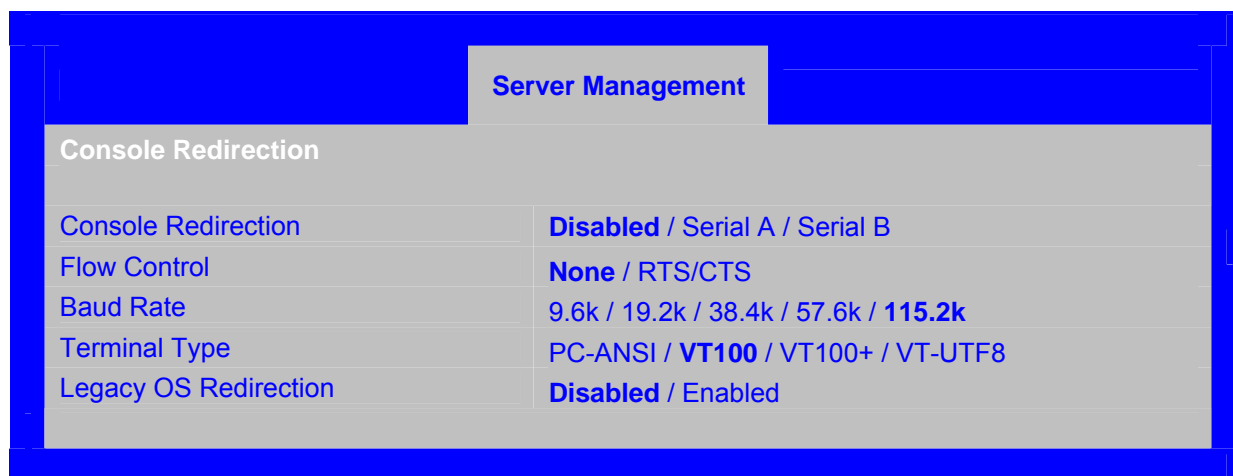

Figure 23. Setup Utility — Console Redirection Screen Display

Table 30. Setup Utility — Console Redirection Configuration Fields

Setup Item	Options	Help Text
Console Redirection	Disabled Serial A Serial B	Console redirection allows a serial port to be used for server management tasks. [Disabled] - No console redirection. [Serial Port A] - Configure serial port A for console redirection. [Serial Port B] - Configure serial port B for console redirection. Enabling this option will disable display of the Quiet Boot logo screen during POST.
Flow Control	None RTS/CTS	Flow control is the handshake protocol. Setting must match the remote terminal application. [None] - Configure for no flow control. [RTS/CTS] - Configure for hardware flow control.
Baud Rate	9600 19.2K 38.4K 57.6K 115.2K	Serial port transmission speed. Setting must match the remote terminal application.
Terminal Type	PC-ANSI VT100 VT100+ VT-UTF8	Character formatting used for console redirection. Setting must match the remote terminal application.
Legacy OS Redirection	Disabled Enabled	This option will enable legacy OS redirection (i.e., DOS) on serial port. If it is enabled the associated serial port will be hidden from the legacy OS.

4.3.2.5 Server Management System Information Screen

The Server Management System Information screen provides a place to see part numbers, serial numbers, and firmware revisions.

To access this screen from the Main screen, select Server Management. Select the System Information option from the Server Management screen.

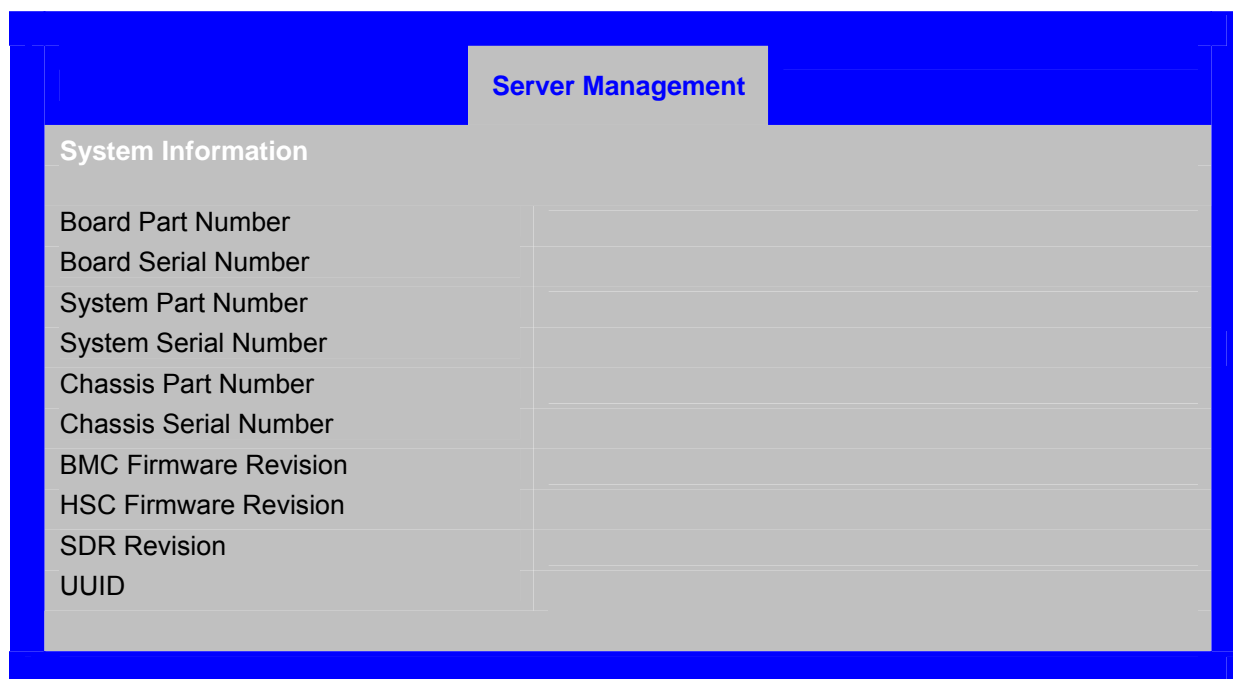

Figure 24. Setup Utility — Server Management System Information Screen Display

Table 31. Setup Utility — Server Management System Information Fields

Setup Item	Comments
Board Part Number	Information Only
Board Serial Number	Information Only
System Part Number	Information Only
System Serial Number	Information Only
Chassis Part Number	Information Only
Chassis Serial Number	Information Only
BMC Firmware Revision	Information Only
HSC Firmware Revision	Information Only
SDR Revision	Information Only
UUID	Information Only

4.3.2.6 Boot Options Screen

The Boot Options screen displays any bootable media encountered during POST and allows the user to configure the boot device.

To access this screen from the Main screen, select Boot Options.

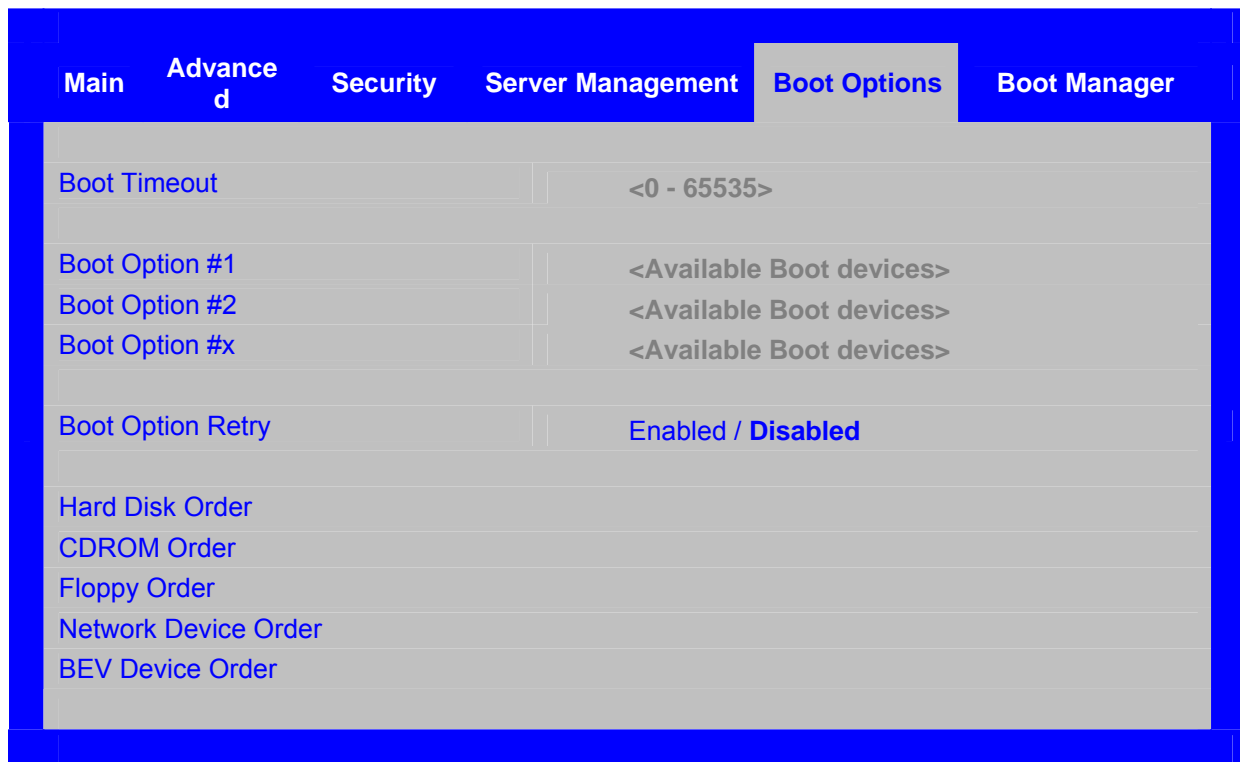

Figure 25. Setup Utility — Boot Options Screen Display

Table 32. Setup Utility — Boot Options Screen Fields

Setup Item	Help Text	Comments
Boot Timeout	The number of seconds BIOS will pause at the end of POST to allow the user to press the [F2] key for entering the BIOS Setup Utility. Valid values are 0-65535. Zero is the default. A value of 65535 will cause the system to go to the Boot Manager menu and wait for user input for every system boot.	After entering the preferred timeout, press Enter to register that timeout value to the system. These settings are in seconds.
Boot Option #x	Set system boot order by selecting the boot option for this position.	
Boot Option Retry		
Hard Disk Order	Set hard disk boot order by selecting the boot option for this position.	Displays when more than one hard disk drive is in the system.
CDROM Order	Set CDROM boot order by selecting the boot option for this position.	Displays when more than one CD-ROM drive is in the system.
Floppy Order	Set floppy disk boot order by selecting the boot option for this position.	Displays when more than one floppy drive is in the system.
Network Device Order	Set network device boot order by selecting the boot option for this position. Add-in or onboard network devices with a PXE option ROM are two examples of network boot devices.	Displays when more than one of these devices is available in the system.
BEV Device Order	Set the Bootstrap Entry Vector (BEV) device boot order by selecting the boot option for this position. BEV devices require their own proprietary method to load an OS using a bootable option ROM. BEV devices are typically found on remote program load devices.	Displays when more than one of these devices is available in the system.

4.3.2.6.1 Hard Disk Order Screen

The Hard Disk Order screen provides a way to control the hard disks.

To access this screen from the Main screen, select Boot Options | Hard Disk Order.

**Figure 26. Setup Utility — Hard Disk Order Screen Display**

Table 33. Setup Utility — Hard Disk Order Fields

Setup Item	Options	Help Text
Hard Disk #1	Available hard disks	Set hard disk boot order by selecting the boot option for this position.
Hard Disk #2	Available hard disks	Set hard disk boot order by selecting the boot option for this position.

4.3.2.6.2 CDROM Order Screen

The CDROM Order screen provides a way to control CD-ROM devices.

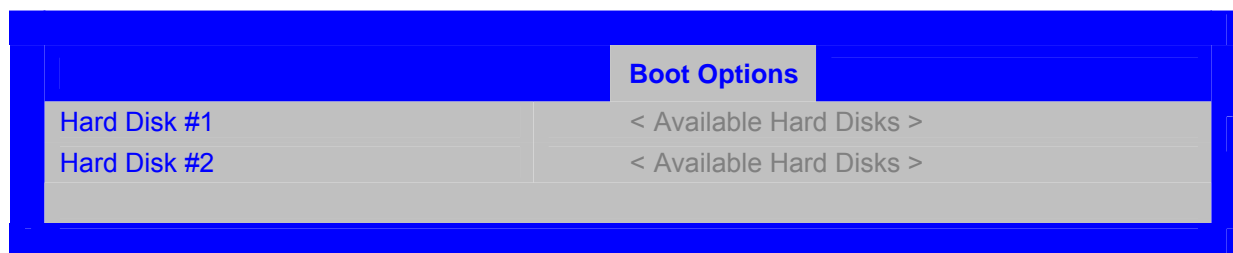
To access this screen from the Main screen, select Boot Options | CDROM Order.

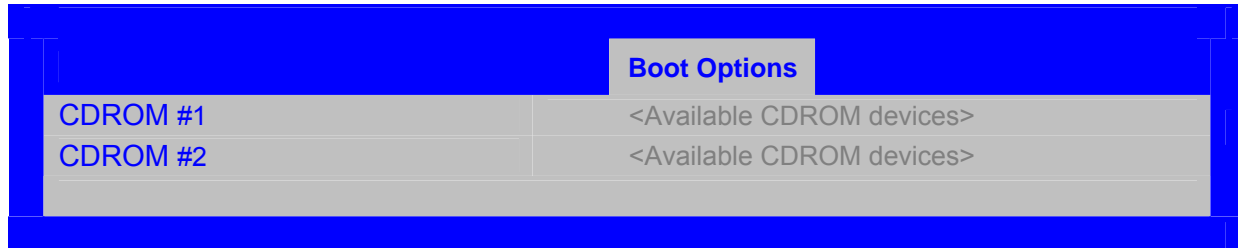

Figure 27. Setup Utility — CDROM Order Screen Display

Table 34. Setup Utility — CDROM Order Fields

Setup Item	Options	Help Text
CDROM #1	Available CDROM devices	Set CDROM boot order by selecting the boot option for this position.
CDROM #2	Available CDROM devices	Set CDROM boot order by selecting the boot option for this position.

4.3.2.6.3 Floppy Order Screen

The Floppy Order screen provides a way to control the floppy disk drives.

To access this screen from the Main screen, select Boot Options | Floppy Order.

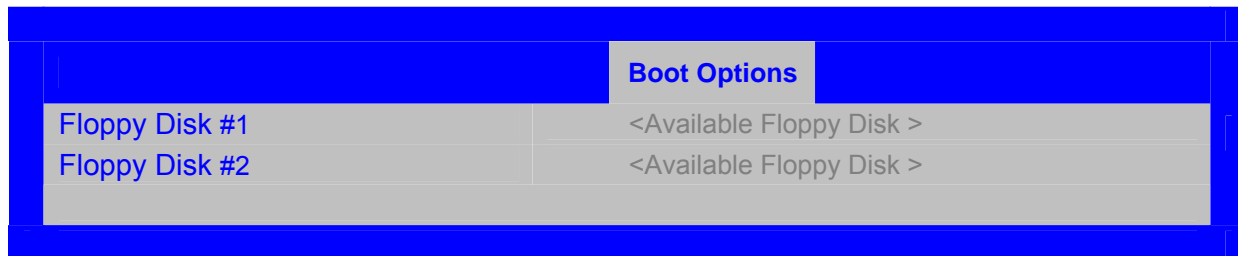

Figure 28. Setup Utility — Floppy Order Screen Display

Table 35. Setup Utility — Floppy Order Fields

Setup Item	Options	Help Text
Floppy Disk #1	Available floppy disk	Set floppy disk boot order by selecting the boot option for this position.
Floppy Disk #2	Available floppy disk	Set floppy disk boot order by selecting the boot option for this position.

4.3.2.6.4 Network Device Order Screen

The Network Device Order screen provides a way to control Network bootable devices.

To access this screen from the Main screen, select Boot Options | Network Device Order.

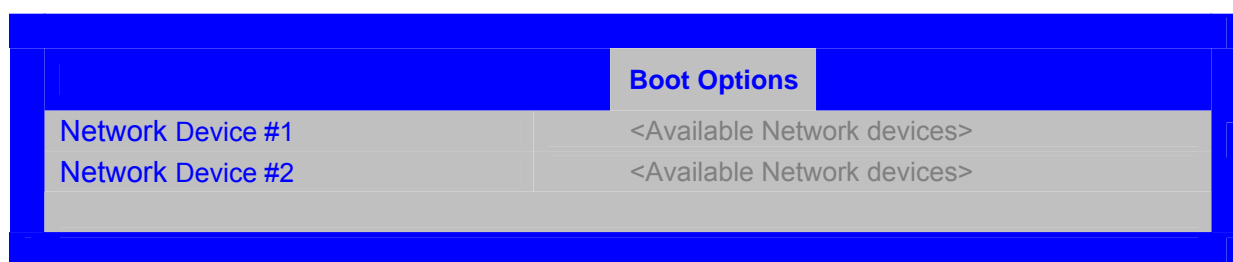
**Figure 29. Setup Utility — Network Device Order Screen Display****Table 36. Setup Utility — Network Device Order Fields**

Setup Item	Options	Help Text
Network Device #1	Available network devices	Set network device boot order by selecting the boot option for this position. Add-in or onboard network devices with a PXE option ROM are two examples of network boot devices.
Network Device #2	Available network devices	Set network device boot order by selecting the boot option for this position. Add-in or onboard network devices with a PXE option ROM are two examples of network boot devices.

4.3.2.6.5 BEV Device Order Screen

The BEV Device Order screen provides a way to control the BEV (Bootstrap Entry Vector) bootable devices.

To access this screen from the Main screen, select Boot Options | BEV Device Order.

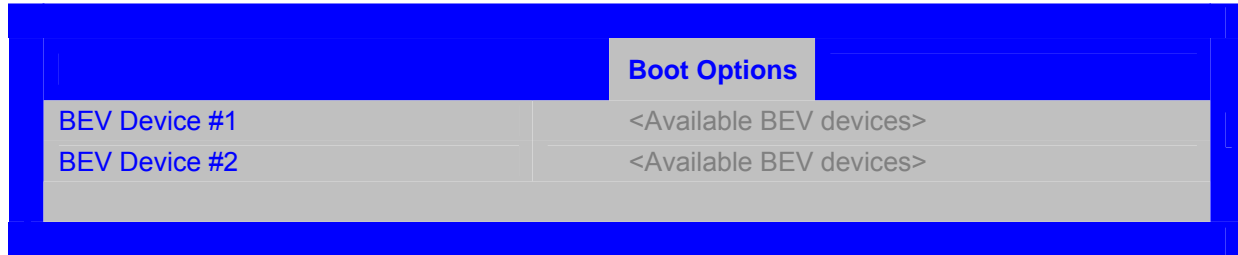

Figure 30. Setup Utility — BEV Device Order Screen Display

Table 37. Setup Utility — BEV Device Order Fields

Setup Item	Options	Help Text
BEV Device #1	Available BEV devices	Set the Bootstrap Entry Vector (BEV) device boot order by selecting the boot option for this position. BEV devices require their own proprietary method to load an OS using a bootable option ROM. BEV devices are typically found on remote program load devices.
BEV Device #2	Available BEV devices	Set the Bootstrap Entry Vector (BEV) device boot order by selecting the boot option for this position. BEV devices require their own proprietary method to load an OS using a bootable option ROM. BEV devices are typically found on remote program load devices.

4.3.2.7 Boot Manager Screen

The Boot Manager screen displays a list of devices available to boot from and allows the user to select a boot device for this boot.

To access this screen from the Main screen, select Boot Manager.

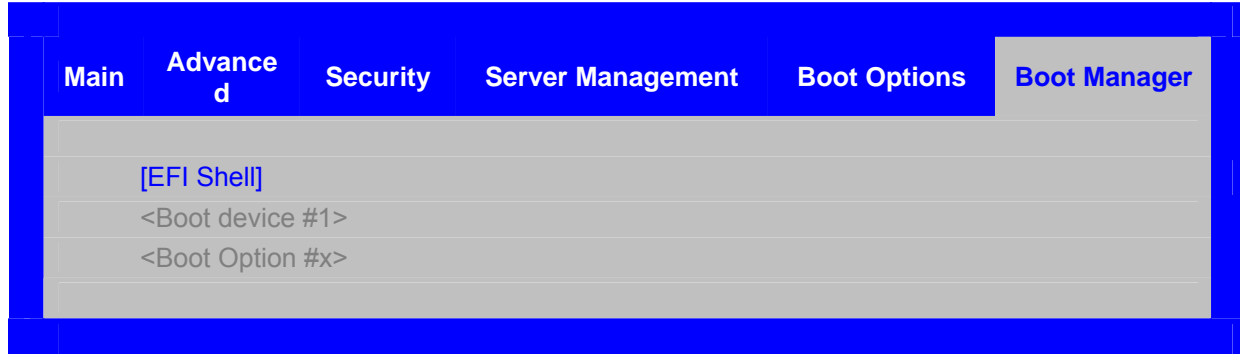

Figure 31. Setup Utility — Boot Manager Screen Display

Table 38. Setup Utility — Boot Manager Screen Fields

Setup Item	Options	Help Text
Launch EFI Shell		Select this option to boot now. Note: This list is not the system boot option order. Use the Boot Options menu to view and configure the system boot option order.
Boot Device #x		Select this option to boot now. Note: This list is not the system boot option order. Use the Boot Options menu to view and configure the system boot option order.

4.3.2.8 Error Manager Screen

The Error Manager screen displays any errors encountered during POST.



Figure 32. Setup Utility — Error Manager Screen Display

Table 39. Setup Utility — Error Manager Screen Fields

Setup Item	Options	Help Text	Comments
Displays System Errors			Information only. Displays errors that occurred during this POST.

4.3.2.9 Exit Screen

The Exit screen allows the user to choose to save or discard the configuration changes made on the other screens. It also provides a method to restore the server to the factory defaults or to save or restore a set of user-defined default values. If Restore Defaults is selected, the default settings, noted in bold in the tables in this chapter, are applied. If Restore User Default Values is selected, the system is restored to the default values the user saved earlier, instead of being restored to the factory defaults.

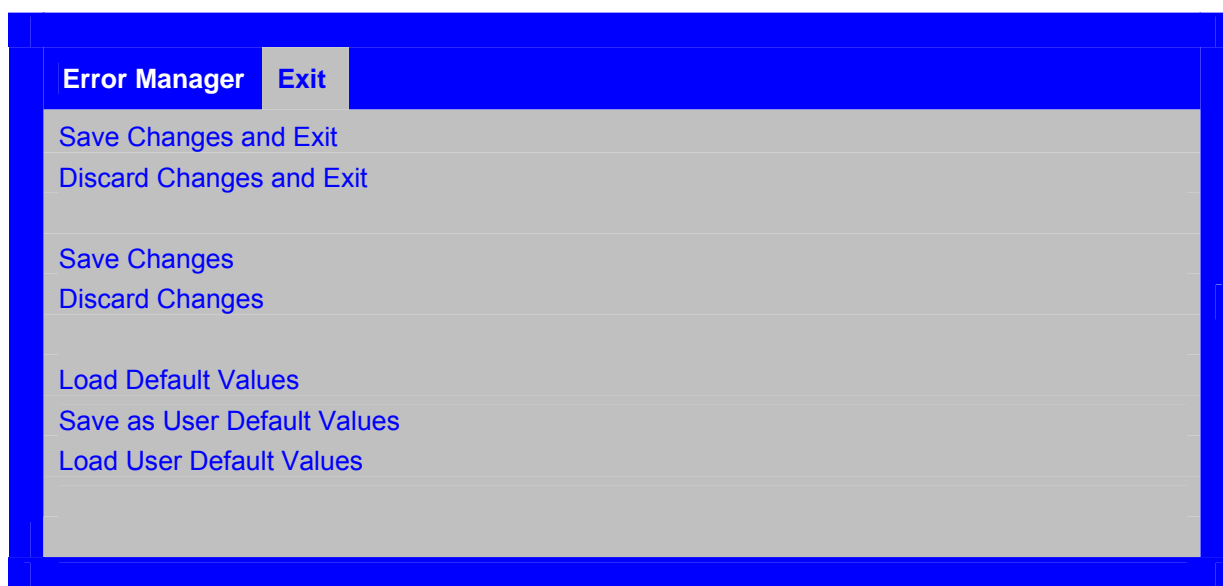
**Figure 33. Setup Utility — Exit Screen Display****Table 40. Setup Utility — Exit Screen Fields**

Setup Item	Help Text	Comments
Save Changes and Exit	Exit BIOS Setup Utility after saving changes. The system will reboot if required. The [F10] key can also be used.	Prompts user for confirmation only if any of the setup fields were modified.
Discard Changes and Exit	Exit BIOS Setup Utility without saving changes. The [Esc] key can also be used.	Prompts user for confirmation only if any of the setup fields were modified.
Save Changes	Save changes without exiting BIOS Setup Utility. Note: Saved changes may require a system reboot before taking effect.	Prompts user for confirmation only if any of the setup fields were modified.
Discard Changes	Discard changes made since the last save changes operation was performed.	Prompts user for confirmation only if any of the setup fields were modified.

Setup Item	Help Text	Comments
Load Default Values	Load factory default values for all BIOS Setup Utility options. The [F9] key can also be used.	Prompts user for confirmation.
Save as User Default Values	Save current BIOS Setup Utility values as custom user default values. If needed, the user default values can be restored via the Load User Default Values option below. Note: Clearing CMOS or NVRAM will cause the user default values to be reset to the factory default values.	Prompts user for confirmation.
Load User Default Values	Load user default values.	Prompts user for confirmation.

4.3.2.9.1 Fan Speed Control Methodology

Intel® Server Boards S3200SH and S3210SH have an integrated BMC (Baseboard Management Controller), which provides advanced fan speed control features compared to previous platforms. The integrated BMC FW and FRUSDR provide HW monitoring, fan speed control, and system management features.

Intel released FRUSDRs will contain the fan speed control support for Intel® server chassis by default. The supported chassis are:

- Intel® Server Chassis SR1530
- Intel® Entry Server Chassis SC5299-UP

For any third party non-Intel chassis, if a customer wants to implement similar fan speed control to the system fans attached inside the third party chassis, they must edit the master.cfg file included in the FRUSDR update package. The FRUSDR manages the system fans to work at the speed the customer inputs.

Intel will publish a third party chassis fan speed control white paper to guide customers on how to edit the master.cfg file to have fan speed control functions for the third party chassis. Without doing so, the third party chassis fan speed cannot be controlled as the FRUSDR does not recognize the fans, and does not know what speed the fans should operate at under which environment temperatures.

4.4 Loading BIOS Defaults

Different mechanisms exist for resetting the system configuration to the default values. When a request to reset the system configuration is detected, the BIOS loads the default system configuration values during the next POST. The request to reset the system to the defaults can be sent in the following ways:

- A request to reset the system configuration can be generated using the BIOS System Configuration Utility (Setup).
- A reset system configuration request can be generated by moving the clear system configuration jumper.

4.5 Multiple Boot Blocks

Two boot blocks are available on this server board.

Multiple Boot Blocks fault tolerant realization requires the BIOS to: 1) recognize the second boot block and dispatch modules within it; 2) provide a flash update interface (for utility) that has an embedded fault-tolerant flash update algorithm so at any time, a set of boot blocks always exists that could recover the system if the flash update failed.

4.6 Recovery Mode

The recovery process can be initiated by setting the recovery jumper, which is called force recovery).

A BIOS recovery can be accomplished from SATA CD and USB Mass Storage device. Please note this platform does not support a recovery from a USB floppy. SATA CD image for recovery is created using El-Torito format image (which is bootable).

The recovery media must contain both the image file FV_MAIN.FV in the root directory and the following files:

1. IFLASH32.EFI
2. *.CAP
3. Startup.nsh

The BIOS starts the recovery process by first loading and booting to the recovery image file (FV_MAIN.FV) on the root directory of the recovery media (SATA CD or USB disk). This process takes place before any video or console is available. Once the system boots to this recovery image file (FV_MAIN.FV), it automatically boots into EFI Shell and invokes the Startup.nsh. and the flash update application (IFLASH32.EFI). IFLASH32.EFI requires the supporting BIOS Capsule image file (*.CAP). At last, there would be two short beeps indicating the completion of the recovery. User should switch the recovery jumper back to normal operation and restart the system by doing a power cycle.

The following steps illustrate the recovery process:

1. Power off the system and insert recovery media.
2. Switch the recovery jumper.
3. Power on the system.
4. The BIOS POST screen appears and displays the progress, and the system automatically boots to the EFI SHELL.
5. The Startup.NSH file is automatically invoked. It initiates the flash update (IFLASH32.EFI) with a new capsule file (*.CAP). If the flash update succeeds, a message displays.
6. Once the flash update is complete, you will hear two beeps. Power off the system, and revert the recovery jumper back to normal operation.
7. Power on the system. DO NOT INTERRUPT THE POST PROCESS AT THE FIRST BOOT.

4.7 Intel® Matrix Storage Manager

Intel® Matrix Storage Manager provides software support for high-performance Serial ATA RAID 0 arrays, fault-tolerant Serial ATA RAID 1 arrays, high capacity and fault-tolerant Serial ATA RAID 5 arrays and high performance and fault-tolerant Serial ATA RAID 10 arrays on select supported chipsets using select operating systems. Intel® Matrix Storage Manager is the software that enables Intel® Matrix Storage Technology.

For detailed information and supported operating systems, refer to the following website:
<http://support.intel.com/support/chipsets/imsm/>

4.8 Intel® Embedded Server RAID Technology II Support

The onboard storage capability of this server board includes support for Intel® Embedded Server RAID Technology, which provides three standard software RAID levels: data striping (RAID Level 0), data mirroring (RAID Level 1), and data striping with mirroring (RAID Level 10). For higher performance, you can use data striping to alleviate disk bottlenecks by taking advantage of the dual independent DMA engines that each SATA port offers. Data mirroring is used for data security. If a disk fails, a mirrored copy of the failed disk is brought online. There is no loss of either PCI resources (request/grant pair), or add-in card slots.

For detailed information and supported operating systems, refer to the following website:
<http://support.intel.com/support/chipsets/imsm/>

5. Error Reporting and Handling

This chapter defines the following error handling features:

- Error Handling and Logging
- Error Messages and Beep Codes

5.1 Error Handling and Logging

This section defines how errors are handled by the system BIOS. In addition, this section describes error-logging techniques and defines error beep codes.

5.1.1 Error Sources and Types

One of the major requirements of server management is to correctly and consistently handle system errors. System errors you can enable and disable individually or as a group are categorized as follows:

- PCI bus
- Memory single- and multi-bit errors
- Errors detected during POST, logged as POST errors

The event list follows:

Table 41. Event List

Event Name	Description	When Error Is Caught
Processor thermal trip of last boot	Processor thermal trip happened on last boot.	POST
Memory channel A Multi-bit ECC error	Multi-bit ECC error happened on DIMM channel A.	POST / Runtime
Memory channel A Single-bit ECC error	Single-bit ECC error happened on DIMM channel A.	POST / Runtime
Memory channel B Multi-bit ECC error	Multi-bit ECC error happened on DIMM channel B.	POST / Runtime
Memory channel B Single-bit ECC error	Single-bit ECC error happened on DIMM channel B.	POST / Runtime
CMOS battery failure	CMOS battery failure or CMOS clear jumper is set to clear CMOS.	POST
CMOS checksum error	CMOS data crushed	POST
CMOS time not set	CMOS time is not set	POST
Keyboard not found	PS/2 KB is not found during POST	POST
Memory size decrease	Memory size is decreased compared with last boot	POST
Chassis intrusion detected	Chassis is open	POST
Bad SPD tolerance	Some fields of the DIMM SPD may not be supported, but could be tolerant by the Memory Reference Code.	POST
PCI PERR error	PERR error happens on PCI bus	POST / Runtime
PCI SERR error	SERR error happens on PCI bus	POST / Runtime

5.1.2 Error Logging via SMI Handler

The SMI (System Management Interrupt) handler manages and logs system level events. The SMI handler pre-processes all system errors, even those that are normally considered to generate an NMI (Non-maskable interrupt).

The SMI handler logs the event to NVRAM (Non-volatile Random Access Memory). For example, the BIOS programs the hardware to generate SMI on a single-bit memory error and logs the error in the NVRAM in the terms of SMBIOS Type 15. After the BIOS finishes logging the error, it asserts the NMI if needed.

5.1.2.1 PCI Bus Error

The PCI bus defines two error pins, PERR# and SERR#. These are used for reporting PCI parity errors and system errors, respectively.

In the case of PERR#, the PCI bus master has the option to retry the offending transaction, or to report it using SERR#. All other PCI-related errors are reported by SERR#. All PCI-to-PCI bridges are configured so they generate SERR# on the primary interface whenever there is SERR# on the secondary side. Section 5.1.4 describes the format of the data bytes.

5.1.2.2 PCI Express* Errors

All uncorrectable PCI Express* errors are logged as PCI system errors and promoted to an NMI. All correctable PCI Express* errors are logged as PCI parity errors.

5.1.2.3 Memory Errors

The hardware is programmed to generate an SMI on correctable data errors in the memory array. The SMI handler records the error to the NVRAM. The uncorrectable errors may have corrupted the contents of SMRAM. If the SMRAM contents are still valid, the SMI handler logs the error to the NVRAM if the SMRAM contents are still valid. Section 5.1.4 describes the format of the data bytes.

5.1.3 SMBIOS Type 15

Errors are logged to NVRAM in the terms of SMBIOS Type 15 (System Event Log). Refer to the SMBIOS Specification, version 2.4 for more detailed information. The following section also defines the format of the records.

5.1.4 Logging Format Conventions

The BIOS logs an error into the NVRAM area with the following record format, which is defined in the SMBIOS Specification, version 2.4.

Table 42. SMBIOS Type 15 Event Log record format

Offset	Name	Length	Description
00h	EventType	Byte	Specifies the “Type” of event noted in an event-log entry as defined in the table.
01h	Length	Byte	Specifies the byte length of the event record including the record’s Type and Length fields.
02h	Year	Byte	Indicates the time when the error is logged.
03h	Month	Byte	
04h	Day	Byte	
05h	Hour	Byte	
06h	Minute	Byte	
07h	Second	Byte	
08h	EventData1	DWORD	EFI_STATUS_CODE_TYPE
0Ch	EventData2	DWORD	EFI_STATUS_CODE_VALUE

Table 43. Event Type Definition Table

Value	Description	Used by this platform (Y/N)
00h	Reserved	N
01h	Single-bit ECC memory error	Y
02h	Multi-bit ECC memory error	Y
03h	Parity memory error	N
04h	Bus time-out	N
05h	I/O Channel Check	N
06h	Software NMI	N
07h	POST Memory Resize	N
08h	POST Error	Y
09h	PCI Parity Error	Y
0Ah	PCI System Error	Y
0Bh	CPU Failure	N
0Ch	EISA FailSafe Timer time-out	N
0Dh	Correctable memory log disabled	N
0Eh	Logging disabled for a specific Event Type – too many errors of the same type received in a short amount of time	N
0Fh	Reserved	N
10h	System Limit Exceeded (for example, voltage or temperature threshold exceeded)	Y
11h	Asynchronous hardware timer expired and issued a system reset	N
12h	System configuration information	N
13h	Hard-disk information	N
14h	System reconfigured	N
15h	Uncorrectable CPU-complex error	N

Value	Description	Used by this platform (Y/N)
16h	Log Area Reset/Cleared	Y
17h	System boot. If implemented, this log entry is guaranteed to be the first one written on any system boot.	N
18h-7Fh	Unused, available for assignment by SMBIOS Specification Version 2.3.4.	N
80h-FEh	Available for system- and OEM-specific assignments	Y
FFh	End-of-log. When an application searches through the event-log records, the end of the log is identified when a log record with this type is found.	Y

For information on the `EFI_STATUS_CODE_TYPE` and `EFI_STATUS_CODE_VALUE` definitions, refer to the “Intel Platform Innovation Framework for EFI Status Codes Specification”, version 0.92.

The errors also display on the BIOS Setup screen in the Server Management / View EventLog menu in the following format:

EventName (times) Time of Occurrence

EventName is the same as shown in the Table 41 followed by the occurrence time of the same event. The “Time of Occurrence” is the last time the event occurs.

5.2 Error Messages and Error Codes

The system BIOS displays error messages on the video screen. Before video initialization, beep codes inform the user of errors. The event log logs POST error codes. The BIOS displays POST error codes on the video monitor.

5.2.1 Diagnostic LEDs

During the system boot process, the BIOS executes several platform configuration processes, each of which is assigned a specific hex POST code number. As each configuration routine is started, the BIOS displays the POST code on the POST code diagnostic LEDs found on the back edge of the server board. To assist in troubleshooting a system hang during the POST process, you can use the diagnostic LEDs to identify the last POST process executed.

Each POST code is represented by a combination of colors from the four LEDs. The LEDs are capable of displaying three colors: green, red, and amber. The POST codes are divided into an upper nibble and a lower nibble. A red LED represents each bit in the upper nibble and a green LED represents each bit in the lower nibble. If both bits are set in the upper and lower nibbles then both red and green LEDs are lit, resulting in an amber color. If both bits are clear, then the LED is off.

In the following example, the BIOS sends a value of ACh to the diagnostic LED decoder. The LEDs are decoded as follows:

- Red bits = 1010b = Ah

- Green bits = 1100b = Ch

Since the red bits correspond to the upper nibble and the green bits correspond to the lower nibble, the two are concatenated to be ACh.

Table 44. POST Progress Code LED Example

LEDs	8h		4h		2h		1h	
	Red	Green	Red	Green	Red	Green	Red	Green
ACh	1	1	0	1	1	0	0	0
Result	Amber		Green		Red		Off	
	MSB						LSB	

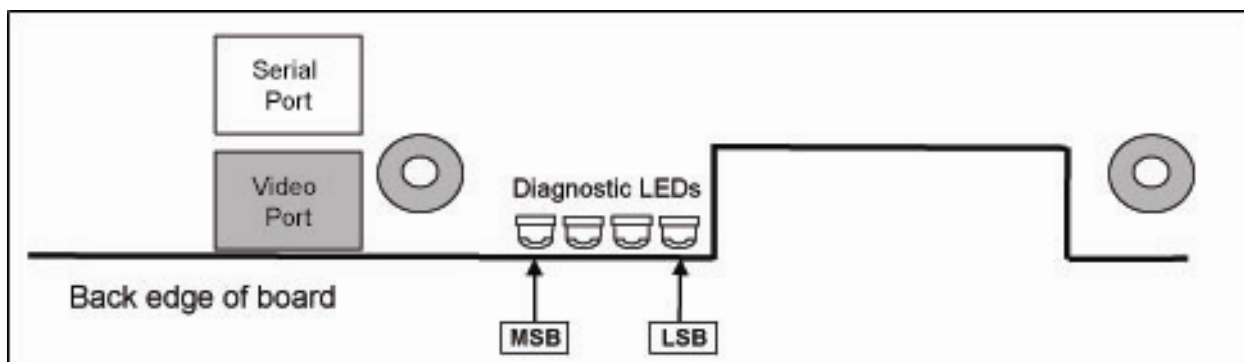

Figure 34. Example of Diagnostic LEDs on Server Board

5.2.2 POST Code Checkpoints

Table 45. POST Code Checkpoints

Checkpoint	Diagnostic LED Decoder				Description
	G=Green, R=Red, A=Amber				
	MSB			LSB	
Host Processor					
0x10h	Off	off	off	R	Power-on initialization of the host processor (bootstrap processor)
0x11h	Off	Off	Off	A	Host processor cache initialization (including AP)
0x12h	Off	Off	G	R	Starting application processor initialization
0x13h	Off	Off	G	A	SMM initialization
Chipset					
0x21h	OFF	OFF	R	G	Initializing a chipset component
Memory					
0x22h	OFF	OFF	A	OFF	Reading configuration data from memory (SPD on DIMM)
0x23h	OFF	OFF	A	G	Detecting presence of memory
0x24h	OFF	G	R	OFF	Programming timing parameters in the memory controller
0x25h	OFF	G	R	G	Configuring memory parameters in the memory controller

Checkpoint	Diagnostic LED Decoder				Description
	G=Green, R=Red, A=Amber				
	MSB			LSB	
0x26h	OFF	G	A	OFF	Optimizing memory controller settings
0x27h	OFF	G	A	G	Initializing memory, such as ECC init
0x28h	G	OFF	R	OFF	Testing memory
PCI Bus					
0x50h	OFF	R	OFF	R	Enumerating PCI buses
0x51h	OFF	R	OFF	A	Allocating resources to PCI buses
0x52h	OFF	R	G	R	Hot Plug PCI controller initialization
0x53h	OFF	R	G	A	Reserved for PCI bus
0x54h	OFF	A	OFF	R	Reserved for PCI bus
0x55h	OFF	A	OFF	A	Reserved for PCI bus
0x56h	OFF	A	G	R	Reserved for PCI bus
0x57h	OFF	A	G	A	Reserved for PCI bus
USB					
0x58h	G	R	OFF	R	Resetting USB bus
0x59h	G	R	OFF	A	Reserved for USB devices
ATA / ATAPI / SATA					
0x5Ah	G	R	G	R	Begin SATA bus initialization
0x5Bh	G	R	G	A	Reserved for ATA
SMBUS					
0x5Ch	G	A	OFF	R	Resetting SMBUS
0x5Dh	G	A	OFF	A	Reserved for SMBUS
Local Console					
0x70h	OFF	R	R	R	Resetting the video controller (VGA)
0x71h	OFF	R	R	A	Disabling the video controller (VGA)
0x72h	OFF	R	A	R	Enabling the video controller (VGA)
Remote Console					
0x78h	G	R	R	R	Resetting the console controller
0x79h	G	R	R	A	Disabling the console controller
0x7Ah	G	R	A	R	Enabling the console controller
Keyboard (PS/2 or USB)					
0x90h	R	OFF	OFF	R	Resetting the keyboard
0x91h	R	OFF	OFF	A	Disabling the keyboard
0x92h	R	OFF	G	R	Resetting the keyboard
0x93h	R	OFF	G	A	Enabling the keyboard
0x94h	R	G	OFF	R	Clearing keyboard input buffer
0x95h	R	G	OFF	A	Instructing keyboard controller to run Self Test (PS/2 only)
Mouse (PS/2 or USB)					
0x98h	A	OFF	OFF	R	Resetting the mouse
0x99h	A	OFF	OFF	A	Detecting the mouse
0x9Ah	A	OFF	G	R	Detecting the presence of mouse
0x9Bh	A	OFF	G	A	Enabling the mouse
Fixed Media					
0xB0h	R	OFF	R	R	Resetting fixed media device
0xB1h	R	OFF	R	A	Disabling fixed media device

Checkpoint	Diagnostic LED Decoder				Description
	G=Green, R=Red, A=Amber				
	MSB			LSB	
0xB2h	R	OFF	A	R	Detecting presence of a fixed media device (IDE hard drive detection, and so forth)
0xB3h	R	OFF	A	A	Enabling / configuring a fixed media device
Removable Media					
0xB8h	A	OFF	R	R	Resetting removable media device
0xB9h	A	OFF	R	A	Disabling removable media device
0xBAh	A	OFF	A	R	Detecting presence of a removable media device (IDE CDROM detection, and so forth)
0xBCh	A	G	R	R	Enabling / configuring a removable media device
Boot Device Selection					
0xD0	R	R	OFF	R	Trying boot device selection
0xD1	R	R	OFF	A	Trying boot device selection
0xD2	R	R	G	R	Trying boot device selection
0xD3	R	R	G	A	Trying boot device selection
0xD4	R	A	OFF	R	Trying boot device selection
0xD5	R	A	OFF	A	Trying boot device selection
0xD6	R	A	G	R	Trying boot device selection
0xD7	R	A	G	A	Trying boot device selection
0xD8	A	R	OFF	R	Trying boot device selection
0xD9	A	R	OFF	A	Trying boot device selection
0XDA	A	R	G	R	Trying boot device selection
0xDB	A	R	G	A	Trying boot device selection
0xDC	A	A	OFF	R	Trying boot device selection
0xDE	A	A	G	R	Trying boot device selection
0xDF	A	A	G	A	Trying boot device selection
Pre-EFI Initialization (PEI) Core					
0xE0h	R	R	R	OFF	Started dispatching an PEIM
0xE1h	R	R	R	G	Completed dispatching an PEIM
0xE2h	R	R	A	OFF	Initial memory found, configured, and installed correctly
0xE3h	R	R	A	G	Reserved for initialization module use (PEIM)
Driver Execution Environment (DXE) Core					
0xE4h	R	A	R	OFF	Entered EFI driver execution phase (DXE)
0xE5h	R	A	R	G	Reserved for DXE core use
0xE6h	R	A	A	OFF	Started connecting drivers
0xEBh	A	R	A	G	Started dispatching a driver
0xECh	R	A	A	OFF	Completed dispatching a driver
DXE Drivers					
0xE7h	R	A	A	G	Waiting for user input
0xE8h	A	R	R	OFF	Checking password
0xE9h	A	R	R	G	Entering BIOS setup
0xEAh	A	R	A	OFF	Flash Update
0xEEh	A	A	A	OFF	Calling Int 19; one beep unless silent boot is enabled.
0xEFh	A	A	A	G	Reserved for DXE Drivers use
Runtime Phase / EFI Operating System Boot					
0xF4h	R	A	R	R	Entering Sleep state

Checkpoint	Diagnostic LED Decoder				Description
	G=Green, R=Red, A=Amber				
	MSB			LSB	
0xF5h	R	A	R	A	Exiting Sleep state
0xF8h	A	R	R	R	Operating system has requested EFI to close boot services (ExitBootServices () has been called)
0xF9h	A	R	R	A	Operating system has switched to virtual address mode (SetVirtualAddressMap () has been called)
0xFAh	A	R	A	R	Operating system has requested the system to reset (ResetSystem () has been called)
Pre-EFI Initialization Module (PEIM) / Recovery					
0x30h	OFF	OFF	R	R	Crisis recovery has been initiated because of a user request
0x31h	OFF	OFF	R	A	Crisis recovery has been initiated by software (corrupt flash)
0x34h	OFF	G	R	R	Loading crisis recovery capsule
0x35h	OFF	G	R	A	Handing off control to the crisis recovery capsule
0x3Fh	G	G	A	A	Unable to complete crisis recovery.

5.2.3 POST Error Messages and Handling

Whenever possible, the BIOS outputs the current boot progress codes on the video screen. Progress codes are 32-bit quantities plus optional data. The 32-bit numbers include class, subclass, and operation information. The class and subclass fields point to the type of hardware being initialized. The operation field represents the specific initialization activity. Based on the data bit availability to display progress codes, a progress code can be customized to fit the data width. The higher the data bit, the higher the granularity of information that can be sent on the progress port. The progress codes may be reported by the system BIOS or option ROMs.

The Response section in the following table is divided into two types:

- **Pause:** The message is displayed in the Error Manager screen, an error may be logged to the NVRAM, and user input is required to continue. The user can take immediate corrective action or choose to continue booting.
- **Halt:** The message is displayed in the Error Manager screen, an error is logged to the NVRAM, and the system cannot boot unless the error is resolved. The user needs to replace the faulty part and restart the system.

Table 46. POST Error Messages and Handling

Error Code	Error Message	Response	Log Error
	CMOS date / time not set	Pause	Y
	Configuration cleared by jumper	Pause	Y
	Configuration default loaded	Pause	N
	Password check failed	Halt	N
	PCI resource conflict	Pause	N
	Insufficient memory to shadow PCI ROM	Pause	N
	Processor thermal trip error on last boot	Pause	Y

5.2.4 POST Error Beep Codes

The following table lists POST error beep codes. Prior to system video initialization, the BIOS uses these beep codes to inform users of error conditions. The beep code is followed by a user-visible code on the POST progress LEDs.

Table 47. POST Error Beep Codes

Beeps	Error Message	POST Progress Code	Description
3	Memory error		System halted because a fatal error related to the memory was detected.

5.2.5 POST Error Pause Option

In case of POST error(s) that are listed as "Pause", the BIOS will enter the error manager and wait for the user to press an appropriate key before booting the operating system or entering the BIOS Setup.

The user can override this option by setting "POST Error Pause" to "disabled" in the BIOS setup Main menu page. If the "POST Error Pause" option is set to "disabled", the system boots the operating system without user-intervention. The default value is set to "enabled".

6. Connectors and Jumper Blocks

6.1 Power Connectors

6.1.1 Main Power Connector

The following table defines the pin-out of the main power connector.

Table 48. Power Connector Pin-out (J4G1)

Pin	Signal	18 AWG Color	Pin	Signal	18 AWG Color
1*	+3.3VDC 3.3V RS	Orange Orange (24AWG)	13	+3.3VDC	Orange
2	+3.3VDC	Orange	14	-12VDC	Blue
3*	COM COM RS	Black Black (24AWG)	15	COM	Black
4*	+5VDC 5V RS	Red Red (24AWG)	16	PSON#	Green
5	COM	Black	17	COM	Black
6	+5VDC	Red	18	COM	Black
7	COM	Black	19	COM	Black
8	PWR OK	Gray	20	Reserved	N.C.
9	5 VSB	Purple	21	+5VDC	Red
10	+12V3	Yellow	22	+5VDC	Red
11	+12V3	Yellow	23	+5VDC	Red
12	+3.3VDC	Orange	24	COM	Black

Table 49. Auxiliary CPU Power Connector Pin-out (J9B2)

Pin	Signal	18 AWG color	Pin	Signal	18 AWG Color
1	COM	Black	5*	+12V1 12V1 RS	White Yellow (24AWG)
2	COM	Black	6	+12V1	White
3	COM	Black	7	+12V2	Brown
4	COM	Black	8*	+12V2 12V2 RS	Brown Yellow (24AWG)

6.2 Intel® Riser Card for L SKU

The Intel® Server Board S3200SH-L has a PCI Express* x16 to PCI Express* x16 riser card.

This riser card is designed to be populated with PCI Express* x16 slot on the Intel® Server Board S3200SH-L. The physical layout to the PCI Express* x16 slot on the riser card is PCI Express* x8.

This riser card is designed for populating the Intel® Server Board S3200SH-L into the Intel® Server Chassis SR1530.

6.3 SMBus Connector

Table 50. SMBus Connector Pin-out (J1E1)

Pin	Signal Name	Description
1	SMB_DAT_5V_BP	Data Line
2	GND	GROUND
3	SMB_CLK_5V_BP	Clock Line
4	TP_BP_I2C_HRD_4	Test Point

6.4 Front Panel Connector

A standard SSI 24-pin header is provided to support a system front panel. The header contains reset, NMI, power control buttons, and LED indicators. The following table details the pin-out of this header.

Table 51. Front Panel 24-Pin Header Pin-out (J1K2)

Signal Name	Pin	Signal Name	Pin
FP_PWR_LED_P1	1	P3V3_STBY	2
KEY	3	P5V_STBY	4
FP_GPIO_GRN_BLNK_HDR	5	FP_ID_LED_N	6
P3V3	7	TP_SSI_PIN8	8
LED_HD_N	9	TP_SSI_PIN10	10
FP_SW_ON_HDR_N	11	FP_NIC1_ACT_LED_R_N	12
GND	13	NIC1_LINK_1_N	14
FP_RST_FPHDR_N	15	TP_SSI_PIN16	16
GND	17	TP_SSI_PIN18	18
FP_ID_BTN_N	19	FP_Intruder_HDR_N	20
TP_FM_ONE_WIRE_TEMP_SENSOR	21	FP_NIC2_ACT_LED_R_N	22
TP_SSI_PIN23	23	NIC2_LINK_UP_N	24

6.5 I/O Connectors

6.5.1 VGA Connector

The following table details the pin-out of the VGA connector. This connector is stacked with the COM1 connector.

Table 52. VGA Connector Pin-out (J8B1)

Signal Name	Pin	Signal Name	Pin
RED	B1	Fused VCC (+5V)	B9
GREEN	B2	GND	B10
BLUE	B3	NC	B11
NC	B4	DDCDAT	B12
GND	B5	HSY	B13
GND	B6	VSX	B14
GND	B7	DDCCLK	B15
GND	B8		

Note: NC (No Connect)

6.5.2 NIC Connectors

The server board supports two NIC RJ-45 connectors. The following tables detail the pin-out of the connectors.

Table 53. NIC2-Intel® 82541PI (10/100/1000) Connector Pin-out (J5B1)

Signal Name	Pin	Signal Name	Pin
P1V8_NIC_RC	1	NIC1_DMI0_DN	10
NIC2_DMI2_DN	2	NIC1_DMI0_DNP	11
NIC2_DMI2_DP	3	P1V8_NIC_RC	12
NIC1_DMI2_DP	4	NIC2_LINK1000_N	13
NIC1_DMI2_DN	5	NIC2_LINK100_N	14
P1V8_NIC_RC	6	NIC2_ACT_LED_N	15
P1V8_NIC_RC	7	NIC2_LINK_UP_N	16
NIC1_DMI3_DP	8	GND	MP1
NIC1_DMI3_DN	9	GND	MP2

Table 54. NIC1- Intel® 82566E (10/100/1000) Connector Pin-out (J6B1)

Signal Name	Pin	Signal Name	Pin
P2V5_NIC1	9	P3V3_AUX	20
NIC1_MDI0_DP	10	NIC1_LINK_0_N	21
NIC1_MDI0_DN	11	NIC1_LINK_2_N	22
NIC1_MDI1_DP	12	GND	MP1
NIC1_MDI1_DN	13	GND	MP2
NIC1_MDI2_DP	14	GND	MP3
NIC1_MDI2_DN	15	GND	MP4
NIC1_MDI3_DP	16	GND	MP5
NIC1_MDI3_DN	17	GND	MP6
GND	18	GND	MP7
NIC1_LINK_1_N	19	GND	MP8

6.5.3 SATA Connectors

Table 55 lists the pin-out for the four SATA connectors.

Table 55. SATA Connector Pin-out (J2K1, J1K1, J1J3, J1H3, J1H2, J1H1)

Pin	Signal Name
1	GND
2	SATA0_TX_P
3	SATA0_TX_N
4	GND
5	SATA0_RX_N
6	SATA0_RX_P
7	GND

6.5.4 Floppy Controller Connector

The board provides a standard 34-pin interface to the floppy disk drive controller. The following table details the pin-out of the 34-pin floppy connector.

Table 56. Legacy 34-pin Floppy Connector Pin-out (J3K1)

Signal Name	Pin	Signal Name	Pin
GND	1	FDDENSEL	2
GND	3	Unused	4
KEY	5	FDDRATE0	6
GND	7	FDINDEX#	8
GND	9	FDMTR0#	10
GND	11	FDR1#	12

Signal Name	Pin	Signal Name	Pin
GND	13	FDR0#	14
GND	15	FDMTR1#	16
Unused	17	FDDIR	18
GND	19	FDSTEP#	20
GND	21	FDWDATA#	22
GND	23	FDWGATE#	24
GND	25	FDTRK0#	26
Unused	27	FLWP#	28
GND	29	FRDATA#	30
GND	31	FHDSEL#	32
GND	33	FDSKCHG#	34

6.5.5 Serial Port Connectors

The server board provides one serial port. A standard, external DB9 serial connector is located on the back edge of the server board to supply a serial interface. This connector is stacked with VGA connector (J8A1).

Table 57. External DB9 Serial A Port Pin-out (J8B1)

Signal Name	Pin	Signal Name	Pin
DCD-P	T1	DSR-P	T6
RXD-P	T2	RTS-P	T7
TXD-P	T3	CTS-P	T8
DTR-P	T4	RI-P	T9
GND	T5		

6.5.6 Keyboard and Mouse Connector

Two PS/2 ports are provided for a keyboard and a mouse. The following table details the pin-out of the PS/2 connectors.

Table 58. Keyboard and Mouse PS/2 Connectors Pin-out (J9A1)

PS/2 Connectors	Pin	Signal Name
Keyboard	K1	RKBDATA
	K2	NC
	K3	GND
	K4	P5V_KB_MS
	K5	RKBCLK
	K6	NC
Mouse	M1	MSEDATA
	M2	NC
	M3	GND
	M4	P5V_KB_MS
	M5	RMSCLK
	M6	NC

6.5.7 USB Connector

The following table provides the pin-out for the dual external USB connectors. This connector is stacked with an RJ-45 (connected to NIC1 LAN signals).

Table 59. USB Connectors Pin-out (J5B1)

Pin	Signal Name
U1	P5V_USB_BP_MJ
U2	USB_BACK5_R_DN
U3	USB_BACK5_R_DP
U4	GND
U5	P5V_USB_BP_MJ
U6	USB_BACK4_R_DN
U7	USB_BACK4_R_DP
U8	GND

A header on the server board provides an option to support two additional USB connectors. The following table details the pin-out of the header.

Table 60. Optional USB Connection Header Pin-out (J1G1)

Signal Name	Pin	Signal Name	Pin
NC	1	Key	2
GND	3	GND	4
USB_FRONT1_INDUCTOR_DP	5	USB_FRONT2_INDUCTOR_DP	6
USB_FRONT1_INDUCTOR_DN	7	USB_FRONT2_INDUCTOR_DN	8
USB_FNT_PWR	9	USB_FNT_PWR	10

6.6 Fan Headers

The server board supports five general-purpose fan headers. All fan headers are 4-pin fan headers (J7J1, J8D1, J4J1, J6B1, and J6J1) and have the same pin-out.

Table 61. Four-pin Fan Headers Pin-out (J4D1, J1K2, J7K1, and J4K1J6B2)

Pin	Signal Name	Type	Description
1	Ground	Power	GROUND is the power supply ground
2	Fan Power	Power	Fan Power
3	Fan Tach	Out	FAN_TACH signal is connected to the Heceta* to monitor the FAN speed.
4	PWM	Control	Pulse Width Modulation – Fan Speed Control signal

6.7 Miscellaneous Headers and Connectors

6.7.1 Back Panel I/O Connectors

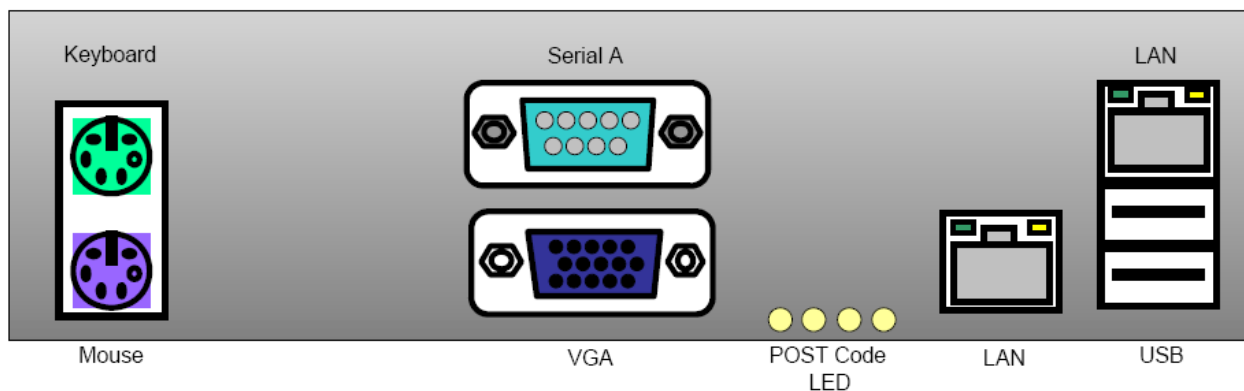

Figure 35. Intel® Server Board S3210SHLX / S3210SHLC / S3200SHL Back Panel I/O Connectors

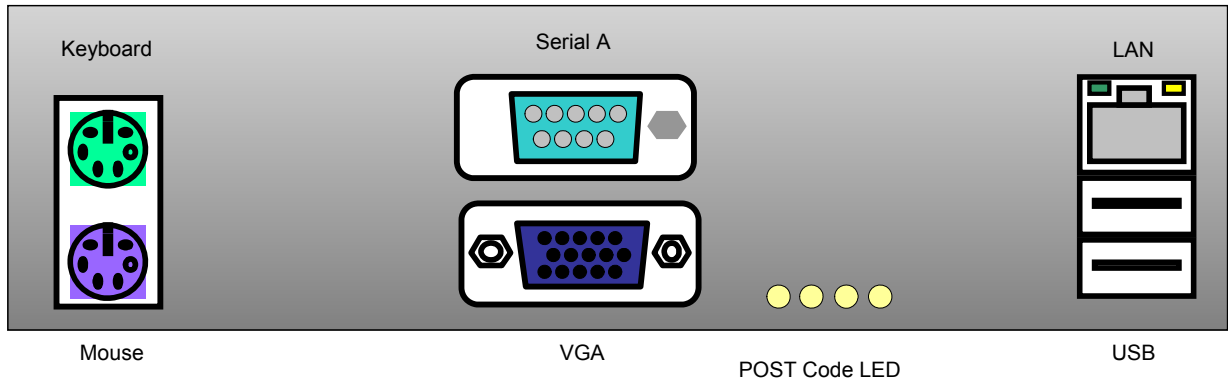

Figure 36. Intel® Server Board S3200SHV Back Panel I/O Connectors

6.7.2 Chassis Intrusion Header

A 1x2 pin header (J1B2) is used in chassis that support a chassis intrusion switch. The Intel® ICH9R monitors this header. Table 62 shows the pin-out definition for this header.

Table 62. Chassis Intrusion Header (J1B2) Pin-out

Pin	Signal Name
1	FP_INTRUDER_HDR_P1
2	FP_INTRUDER_HDR_N

6.7.3 HDD Active LED Header

There is a 1x2 pin header for HDD LED connection. This jumper is reserved for PCI add-in cards that support the SCSI or SATA interface with an external HDD LED activity cable.

Table 63. HDD LED Header (J1J1) Pin-out

Pin	Signal Name
1	FM_SIO_SCSI_ACT_N
2	TP_SCSI_ACT_PIN2

6.7.4 IPMB

There is a 4-pin IPMB connector jumper. This jumper is reserved for connecting an add-in server management module.

6.7.5 HSBP

There is a 4-pin HSBP connector jumper. This jumper is reserved for connecting to the Intel® Entry Server Chassis SC5299-E hot-swap backplane.

6.7.6 SATA SGPIO

There is a 4-pin SATA SGPIO connector jumper. This jumper is reserved for connecting to the Intel® Entry Server Chassis SC5299-E SATA hot-swap backplane.

6.8 Jumper Blocks

This section describes the configuration jumper options on the server board.

Name	Location on LC/LV	Location on LX	Function	Definition
CMOS Clear	J1E3	J1E2	Clear CMOS content	1-2: Normal 2-3: Clear CMOS
Password Clear	J1E2	J1J2	Clear CMOS Password	1-2: Protect Password 2-3: Clear Password
Recovery Mode	J1E1	J1D2	BIOS recovery	1-2: Normal boot 2-3: Recovery mode
BMC Force Update Mode	J1B1	J3A1	BMC Force Update Mode	1-2: BMC in normal mode 2-3: BMC in force update mode
BMC Boot Block Write Protection	J1C2	J1D1	BMC Firmware Flash boot block protection	1-2: Write Protection controlled by firmware 2-3: Force Write Protection

6.8.1 CMOS Clear and Password Reset Usage Procedure

The CMOS Clear and Password Reset recovery features are designed so the desired operation can be achieved with minimal system down time. The usage procedure for these two features has changed from previous generation Intel server boards. The following procedure outlines the new usage model.

1. Power down server. Do not unplug the power cord.
2. Open the server chassis. For instructions, see your server chassis documentation.
3. Move the jumper from the default operating position, covering pins 1 and 2, to the reset / clear position, covering pins 2 and 3.
4. Wait five seconds.
5. Move the jumper back to default position, covering pins 1 and 2.
6. Close the server chassis.
7. Power up the server.

The password and/or CMOS are now cleared and can be reset by going into BIOS setup.

Note: Removing AC Power before performing the CMOS Clear operation causes the system to automatically power up and immediately power down, after the procedure is followed and AC power is re-applied. If this happens, complete the following steps:

1. Remove the AC power cord again and wait 30 seconds.
2. Reinstall the AC power cord and power up the system.
3. Proceed to the <F2> BIOS Setup Utility to reset the settings.

6.8.2 BMC Force Update Procedure

When performing a standard BMC firmware update procedure, the update utility places the BMC into an update mode, allowing the firmware to load safely onto the flash device. In the unlikely event the BMC firmware update process fails due to the BMC not being in the proper update state, the server board provides a BMC Force Update jumper that forces the BMC into the proper update state. If the standard BMC firmware update process fails, complete the following procedure.

1. Power down and remove the AC power cord.
2. Open the server chassis. See your server chassis documentation for instructions.
3. Move the jumper from the default operating position, covering pins 1 and 2, to the enabled position, covering pins 2 and 3.
4. Close the server chassis.
5. Reconnect the AC cord and power up the server.
6. Perform the BMC firmware update procedure as documented in the README.TXT file included in the given BMC firmware update package. After successful completion of the firmware update process, the firmware update utility may generate an error stating the BMC is still in update mode.
7. Power down and remove the AC power cord.
8. Open the server chassis.
9. Move jumper from the enabled position, covering pins 2 and 3 to the disabled position, covering pins 1 and 2.
10. Close the server chassis.
11. Reconnect the AC cord and power up the server.

Note: Normal BMC functionality is disabled if the Force BMC Update jumper is set to the enabled position. The server should never be run with the BMC Force Update jumper set in this position. This jumper setting is only used when the standard firmware update process fails. This jumper should remain in the default / disabled position when the server is running normally.

7. Absolute Maximum Ratings

Operating the server board at conditions beyond those shown in the following table may cause permanent damage to the system. **The table is provided for stress testing purposes only.** Exposure to absolute maximum rating conditions for extended periods may affect system reliability.

Table 64. Absolute Maximum Ratings

Operating Temperature	5 °C to 50 °C 1
Storage Temperature	-55 °C to +150 °C
Voltage on any signal with respect to ground	-0.3 V to Vdd + 0.3V 2
3.3 V Supply Voltage with Respect to ground	-0.3 V to 3.63 V
5 V Supply Voltage with Respect to ground	-0.3 V to 5.5 V

Notes:

1. Chassis design must provide proper airflow to avoid exceeding the processor maximum case temperature.
2. VDD is the supply voltage for the device.

7.1 Mean Time Between Failures (MTBF) Test Results

This section provides results of MTBF (Mean Time Between Failures) testing done by a third-party testing facility. MTBF is a standard measure for the reliability and performance of the board under extreme working conditions. The MTBF was measured at 20000 hours at 35 degrees Celsius.

7.2 Calculated Mean Time Between Failures (MTBF)

The following table shows the MTBF for the server boards as configured from the factory.

Table 65. MTBF Data

Product Code	Calculated MTBF	Operating Temperature
Intel® Server Board S3200SH-L	282569 Hours	35 degrees C
Intel® Server Board S3200SH-V	111326 Hours	55 degrees C
Intel® Server Board S3210SH-LX	265866 Hours	35 degrees C
Intel® Server Board S3210SH-LC	104745 Hours	55 degrees C

8. Design and Environmental Specifications

8.1 Power Budget

The following table shows the power consumed on each supply line for the server board that is configured with one processor (128W max). This configuration includes four 1 GB DDR2 DIMMs stacked burst at 70% max. The numbers provided in Table 66 are for reference purposes only. Different hardware configurations will produce different numbers. The numbers in the table reflect a common usage model operating at higher than average stress levels.

Table 66. Power Budget

Watts			Power Supply Rail Voltages						Units
Functional Unit	Utilization	Power	AMPS						
			3.3V	5V	12.V	12V VRM	-12v	5VSB	
Baseboard Input Totals		290.73W	6.26W	8.47W	6.38W	9.28W	0.05W	1.67	
Baseboard Discrete Totals	50%	32.02W	1.51	1.17	0.00	0.00	0.00	0.00	
Baseboard Converters	Efficiency	41.90W	3.24	7.29	0.00	9.28	0.00	1.67	
Baseboard Config Totals		246.80W	1.52	0.00	6.38	0.00	0.05	0.00	
System Components		49W	0.00	3A	2.8A	0.00	0.00	0.00	
System Components – SR1530		87W	0.00	2.1A	6.4A	0.00	0.00	0.00	
System Totals		335.85W	6.26	10.87	9.14	9.28	0.05	1.67	Amps
System Totals – SR1530									
3.3v/5v Combined Power									
Power Supply Requirements – SC5299-E		350W	22A	21A	10A + 16A=26A		0.8A	2A	
Power supply Requirements – 350W EPS1U		350W peak							
3.3V/5V Combined Power		130W	1Amin	1Amin	2Amin	2Amin	0Amin	1Amin	

8.2 Power Supply Specifications

This section provides power supply design guidelines for the server board, including voltage and current specifications, and power supply on/off sequencing characteristics.

Table 67. Server Board Power Supply Voltage Specification

Parameter	Tolerance	Min	Nom	Max	Units
+ 3.3V	- 5% / +5%	+3.14	+3.30	+3.46	Vrms
+ 5V	- 5% / +5%	+4.75	+5.00	+5.25	Vrms
+ 12V	- 5% / +5%	+11.40	+12.00	+12.60	Vrms
- 12V	- 10% / +10%	-11.40	-12.00	-13.08	Vrms
+ 5VSB	- 5% / +5%	+4.75	+5.00	+5.25	Vrms

8.2.1 Power Timing Requirements

These are the timing requirements for the power supply operation. The output voltages must rise from 10% to within regulation limits (Tvout_rise) within 5 to 70ms, except for 5VSB - it is allowed to rise from 1.0 to 70ms. The +3.3V, +5V and +12V output voltages should start to rise approximately at the same time. **All outputs must rise monotonically.** The +5V output must be greater than the +3.3V output during any point of the voltage rise. The +5V output must never be greater than the +3.3V output by more than 2.25V. Each output voltage shall reach regulation within 50ms (Tvout_on) of each other during turn on of the power supply. Each output voltage shall fall out of regulation within 400msec (Tvout_off) of each other during turn off. Refer to the following table for the timing requirements for the power supply being turned on and off using the AC input with PSON held low and the PSON signal, with the AC input applied.

Table 68. Output Voltage Timing

Item	Description	MIN	MAX	UNITS
Tvout_rise	Output voltage rise time from each main output.	5.0 *	70 *	msec
Tvout_on	All main outputs must be within regulation of each other within this time.		50	msec
Tvout_off	All main outputs must leave regulation within this time.		400	msec

The 5VSB output voltage rise time will be from 1.0ms to 25.0ms.

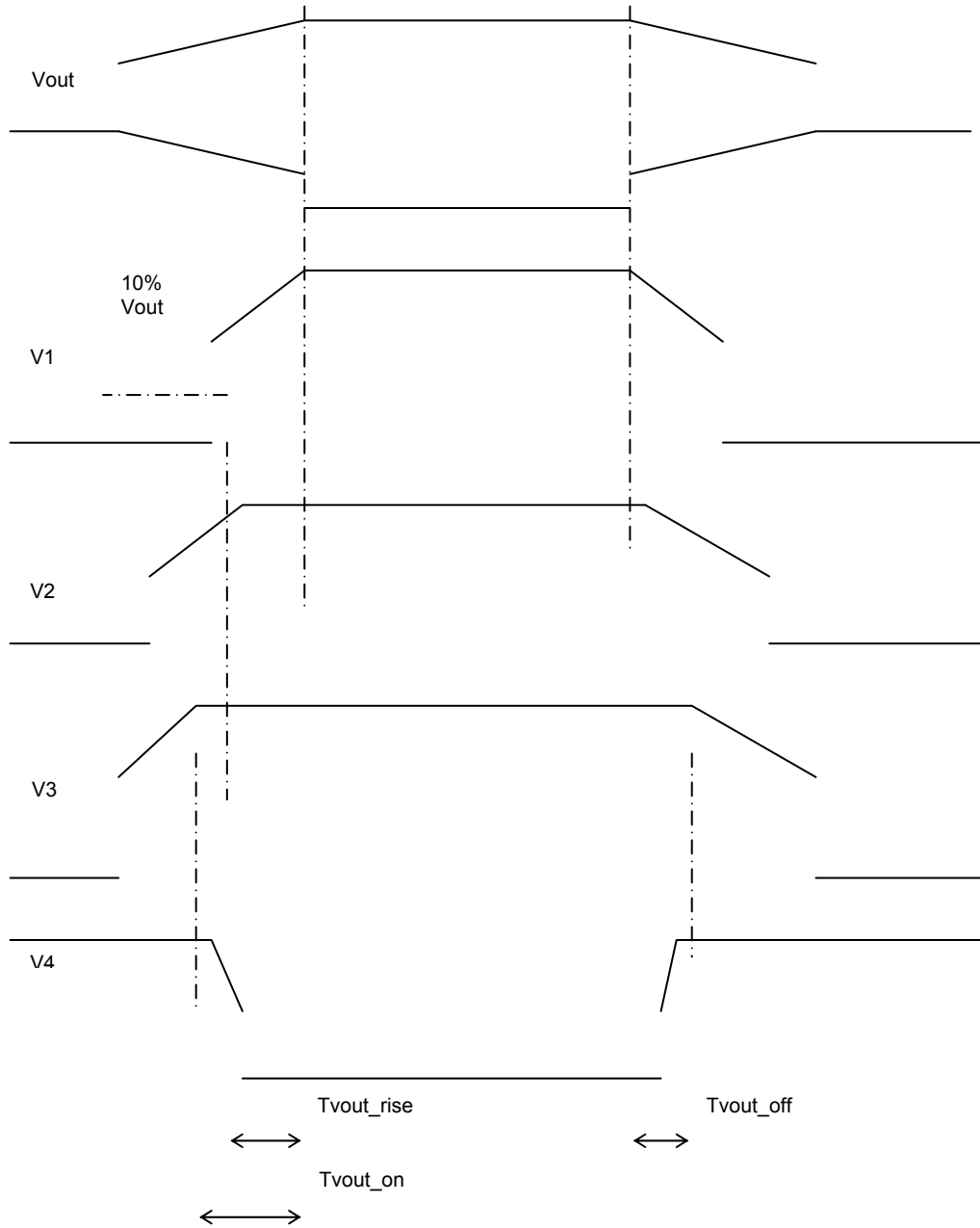

Figure 37. Output Voltage Timing

Table 69. Turn On/Off Timing

Item	Description	Min	Max	Units
Tsb_on_delay	Delay from AC being applied to 5VSB being within regulation.		1500	msec
T ac_on_delay	Delay from AC being applied to all output voltages being within regulation.		2500	msec
Tvout_holdup	Time all output voltages stay within regulation after loss of AC.	21		msec
Tpwok_holdup	Delay from loss of AC to de-assertion of PWOK.	20		msec
Tpson_on_delay	Delay from PSON# active to output voltages within regulation limits.	5	400	msec
T pson_pwok	Delay from PSON# deactive to PWOK being de-asserted.		50	msec
Tpwok_on	Delay from output voltages within regulation limits to PWOK asserted at turn on.	100	1000	msec
T pwok_off	Delay from PWOK de-asserted to output voltages (3.3V, 5V, 12V, -12V) dropping out of regulation limits.	1	200	msec
Tpwok_low	Duration of PWOK being in the de-asserted state during an off/on cycle using AC or the PSON signal.	100		msec
Tsb_vout	Delay from 5VSB being in regulation to O/Ps being in regulation at AC turn on.	50	1000	msec
T5VSB_holdup	Time the 5VSB output voltage stays within regulation after loss of AC.	70		msec

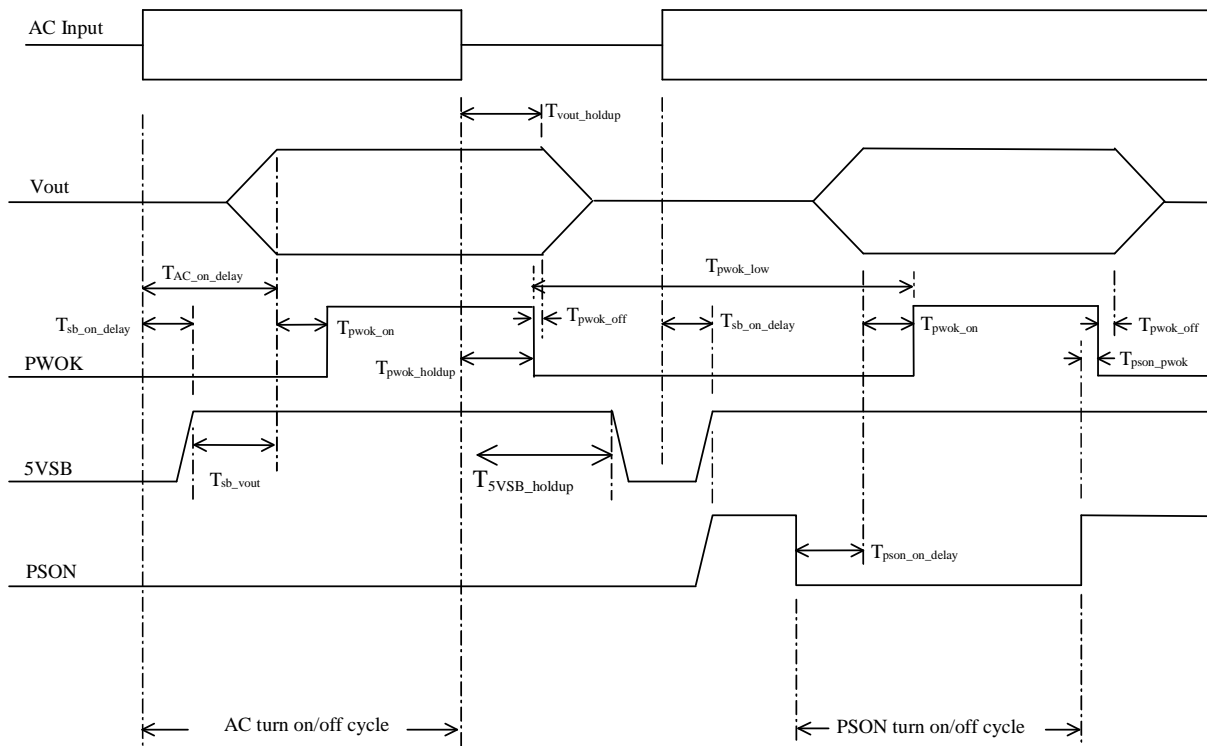

Figure 38. Turn On/Off Timing (Power Supply Signals)

8.2.2 Dynamic Loading

The output voltages should remain within limits specified for the step loading and capacitive loading specified in Table 70. The load transient repetition rate should be tested between 50Hz and 5 kHz at duty cycles ranging from 10%-90%. The load transient repetition rate is only a test specification. The □ step load may occur anywhere within the MIN load to the MAX load conditions.

Table 70. Transient Load Requirements

Output	Step Load Size (See note 2)	Load Slew Rate	Test capacitive Load
+3.3V	5.0A	0.25 A/□sec	250 □F
+5V	6.0A	0.25 A/□sec	400 □F
12V	9.0A	0.25 A/□sec	500 □F
+5VSB	0.5A	0.25 A/□sec	20 □F

Notes:

1. Step loads on each 12V output may happen simultaneously.
2. For Load Range 2 (light system loading), the tested step load size should be 60% of those listed.

8.2.3 AC Line Transient Specification

AC line transient conditions are defined as “sag” and “surge” conditions. “Sag” conditions are also commonly referred to as a “brownout”; these conditions are defined as the AC line voltage dropping below nominal voltage conditions. “Surge” is defined to refer to conditions when the AC line voltage rises above nominal voltage.

The power supply should meet the requirements under the following AC line sag and surge conditions.

Table 71. AC Line Sag Transient Performance

AC Line Sag				
Duration	Sag	Operating AC Voltage	Line Frequency	Performance Criteria
Continuous	10%	Nominal AC Voltage ranges	50/60Hz	No loss of function or performance.
0 to 1 AC cycle	95%	Nominal AC Voltage ranges	50/60Hz	No loss of function or performance.
> 1 AC cycle	>30%	Nominal AC Voltage ranges	50/60Hz	Loss of function acceptable, self-recoverable.

Table 72. AC Line Surge Transient Performance

AC Line Surge				
Duration	Surge	Operating AC Voltage	Line Frequency	Performance Criteria
Continuous	10%	Nominal AC Voltages	50/60Hz	No loss of function or performance.
0 to ½ AC cycle	30%	Mid-point of nominal AC Voltages	50/60Hz	No loss of function or performance.

8.2.4 AC Line Fast Transient (EFT) Specification

The power supply should meet the *EN61000-4-5* directive and any additional requirements in *IEC1000-4-5:1995* and the Level 3 requirements for surge-withstand capability, with the following conditions and exceptions:

- These input transients must not cause any out-of-regulation conditions, such as overshoot and undershoot, nor must it cause any nuisance trips for any of the power supply protection circuits.
- The surge-withstand test must not produce damage to the power supply.
- The supply must meet surge-withstand test conditions under maximum and minimum DC-output load conditions.

8.3 Product Regulatory Compliance

Intended Application – This product was evaluated as Information Technology Equipment (ITE), which may be installed in offices, schools, computer rooms, and similar commercial type locations. The suitability of this product for other product categories and environments (such as medical, industrial, telecommunications, NEBS (Network Equipment Building Systems), residential, alarm systems, test equipment, and so forth), other than an ITE application, may require further evaluation. This is an FCC Class A device. Integration of it into a Class B chassis does not result in a Class B device.

8.3.1 Product Safety Compliance

The server board complies with the following safety requirements:

- UL60950 – CSA 60950(USA / Canada)
- EN60950 (Europe)
- IEC60950 (International)
- CB Certificate and Report, IEC60950 (report to include all country national deviations)
- CE - Low Voltage Directive 73/23/EEE (Europe)

8.3.2 Product EMC Compliance – Class A Compliance

Note: Legally, the product is required to comply with Class A emission requirements as it is intended for a commercial type market place.

- FCC /ICES-003 - Emissions (USA/Canada) Verification
- CISPR 22 – Class A Emissions (International)
- EN55022 – Class A Emissions (Europe)
- EN55024 - Immunity (Europe)
- CE – EMC Directive 89/336/EEC (Europe)
- VCCI, Class A Emissions (Japan)
- AS/NZS 3548 Class A Emissions (Australia / New Zealand)
- BSMI CNS13438 Emissions (Taiwan)
- RRL MIC Notice No. 1997-41 (EMC) and 1997-42 (EMI) (Korea)

8.3.3 Certifications / Registrations / Declarations

- UL Certification (US/Canada)
- CB Certification (International)
- CE Declaration of Conformity (CENELEC Europe)
- FCC/ICES-003 Class A Attestation (USA/Canada)
- C-Tick Declaration of Conformity (Australia)
- MED Declaration of Conformity (New Zealand)
- BSMI Declaration (Taiwan)
- RRL Certification (Korea)

- RoHS (Restriction of Hazardous Substances Directive)

Intel has a system in place to restrict the use of banned substances in accordance with the European Directive 2002/95/EC. Compliance is based on declaration that materials banned in the RoHS Directive are either (1) below all applicable substance threshold limits, or (2) an approved/pending RoHS exemption applies.

Note: RoHS implementation details are not fully defined and may change.







Threshold limits and banned substances are noted:

- Quantity limit of 0.1% by mass (1000 PPM) for:
 - Lead
 - Mercury
 - Hexavalent Chromium
 - Polybrominated Biphenyls Diphenyl Ethers (PBDE)
- Quantity limit of 0.01% by mass (100 PPM) for:
 - Cadmium

8.3.4 Product Regulatory Compliance Markings

This product is marked with the following Product Certification Markings:

Table 73. Product Certification Markings

Regulatory Compliance	Region	Marking
UL Mark	USA/Canada	
CE Mark	Europe	
EMC Marking (Class A)	Canada	CANADA ICES-003 CLASS A CANADA NMB-003 CLASSE A
BSMI Marking (Class A)	Taiwan	 D33025 <div style="border: 1px solid black; padding: 5px; margin-top: 5px;"> <p>警告使用者： 這是甲類的資訊產品，在居住的環境中使用時，可能會造成射頻干擾，在這種情況下，使用者會被要求採取某些適當的對策</p> </div>
Ctick Marking	Australia / New Zealand	
RRL MIC Mark	Korea	 인증번호: CPU-S3200SH (A)
Country of Origin	Exporting Requirements	MADE IN xxxxx
PB Free Marking	Environmental Requirements	 2nd lvl intct

8.4 Electromagnetic Compatibility Notices

8.4.1 FCC (USA)

This device complies with Part 15 of the FCC Rules. Operation is subject to the following two conditions: (1) this device may not cause harmful interference, and (2) this device must accept any interference received, including interference that may cause undesired operation.

For questions related to the EMC performance of this product, contact:

Intel Corporation
5200 N.E. Elam Young Parkway
Hillsboro, OR 97124-6497
1-800-628-8686

This equipment has been tested and found to comply with the limits for a Class A digital device, pursuant to Part 15 of the FCC Rules. These limits are designed to provide reasonable protection against harmful interference in a residential installation. This equipment generates, uses, and can radiate radio frequency energy and, if not installed and used in accordance with the instructions, may cause harmful interference to radio communications. However, there is no guarantee that interference will not occur in a particular installation. If this equipment does cause harmful interference to radio or television reception, which can be determined by turning the equipment off and on, the user is encouraged to try to correct the interference by one or more of the following measures:

- Reposition or relocate the receiving antenna.
- Increase the separation between the equipment and the receiver.
- Connect the equipment to an outlet on a circuit other than the one to which the receiver is connected.
- Consult the dealer or an experienced radio/TV technician for help.

Any changes or modifications not expressly approved by the grantee of this device could void the user's authority to operate the equipment. The customer is responsible for ensuring compliance of the modified product.

Only peripherals (computer input/output devices, terminals, printers, etc.) that comply with FCC Class A or B limits may be attached to this computer product. Operation with noncompliant peripherals is likely to result in interference to radio and TV reception.

All cables used to connect to peripherals must be shielded and grounded. Operation with cables, connected to peripherals that are not shielded and grounded may result in interference to radio and TV reception.

8.4.2 ICES-003 (Canada)

Cet appareil numérique respecte les limites bruits radioélectriques applicables aux appareils numériques de Classe B prescrites dans la norme sur le matériel brouilleur: “Appareils Numériques”, NMB-003 édictée par le Ministre Canadian des Communications.

English translation of the notice above:

This digital apparatus does not exceed the Class B limits for radio noise emissions from digital apparatus set out in the interference-causing equipment standard entitled “Digital Apparatus,” ICES-003 of the Canadian Department of Communications.

8.4.3 Europe (CE Declaration of Conformity)

This product has been tested in accordance to, and complies with the Low Voltage Directive (73/23/EEC) and EMC Directive (89/336/EEC). The product has been marked with the CE Mark to illustrate its compliance.

8.4.4 VCCI (Japan)

この装置は、情報処理装置等電波障害自主規制協議会（VCCI）の基準に基づくクラスB情報技術装置です。この装置は、家庭環境で使用することを目的としていますが、この装置がラジオやテレビジョン受信機に近接して使用されると、受信障害を引き起こすことがあります。
取扱説明書に従って正しい取り扱いをして下さい。

English translation of the notice above:

This is a Class B product based on the standard of the Voluntary Control Council for Interference (VCCI) from Information Technology Equipment. If this is used near a radio or television receiver in a domestic environment, it may cause radio interference. Install and use the equipment according to the instruction manual.

8.4.5 Taiwan Declaration of Conformity (BSMI)

警告使用者：
這是甲類的資訊產品，在居住的環境中使用時，可能會造成射頻干擾，在這種情況下，使用者會被要求採取某些適當的對策

The BSMI Certification Marking and EMC warning is located on the outside rear area of the product.

8.4.6 Korean Compliance (RRL)



1. 기기의 명칭(모델명) :
2. 인증번호 :
3. 인증받은 자의 상호 :
4. 제조년월일 :
5. 제조자/제조국가 :

English translation of the notice above:

Type of Equipment (Model Name): On License and Product

Certification No.: On RRL certificate. Obtain certificate from local Intel representative

Name of Certification Recipient: Intel Corporation

Date of Manufacturer: Refer to date code on product

Manufacturer/Nation: Intel Corporation/Refer to country of origin marked on product

8.5 Mechanical Specifications

The following figure shows the Intel® Server Board S3200SH mechanical drawing. An updated version of this drawing will appear in a future revision of this document.

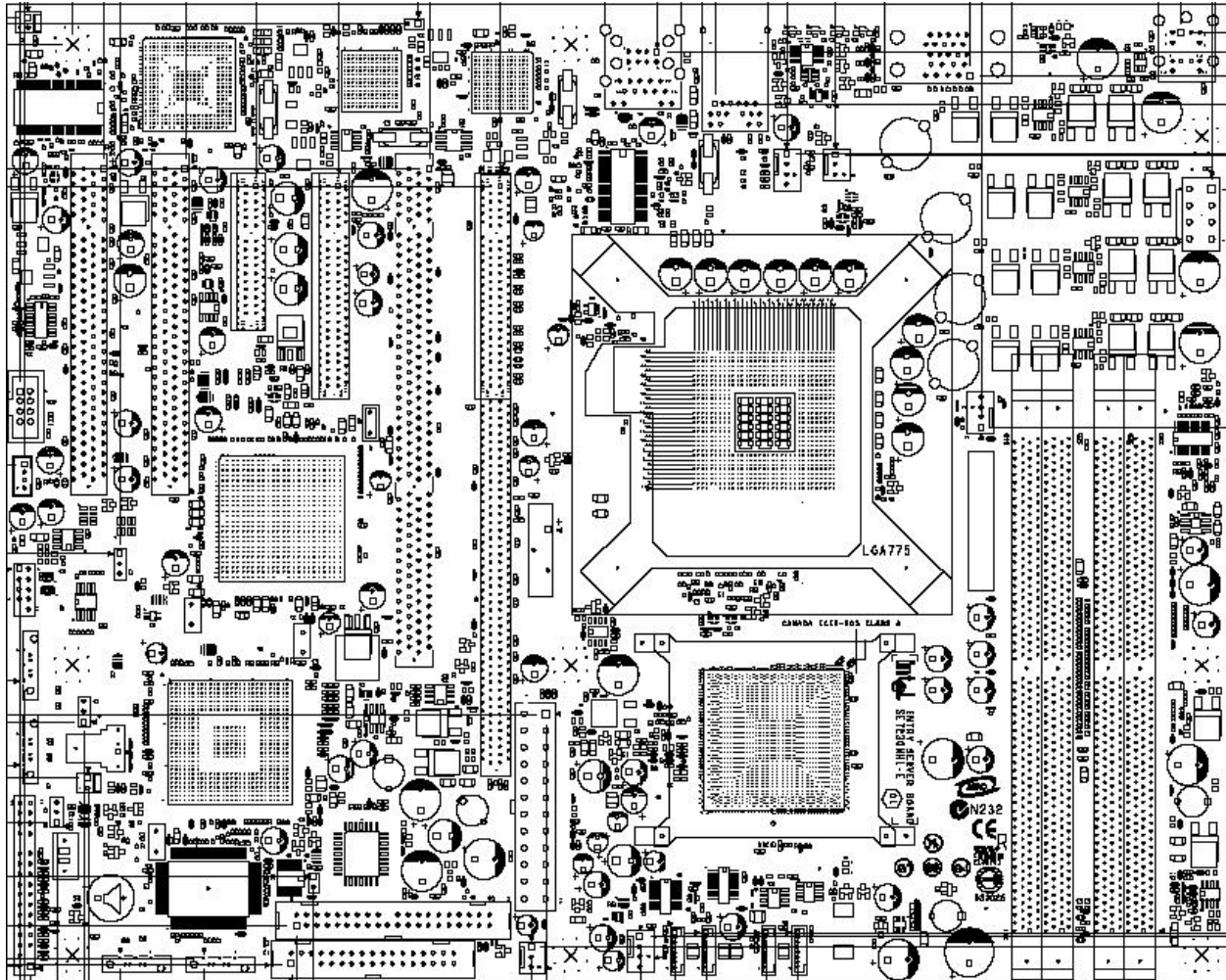

Figure 39. Intel® Server Board S3200SH Mechanical Drawing

The following figures show the I/O shield mechanical drawings for use in pedestal mount applications, such as the Intel® Entry Server Chassis SC5299-E, for the three board SKUs. The Intel® Server Board S3200SH-L and the Intel® Server Board S3200SH-LX/LC share the same I/O shield, and Intel® Server Board S3200SH-V employs a separate I/O shield.

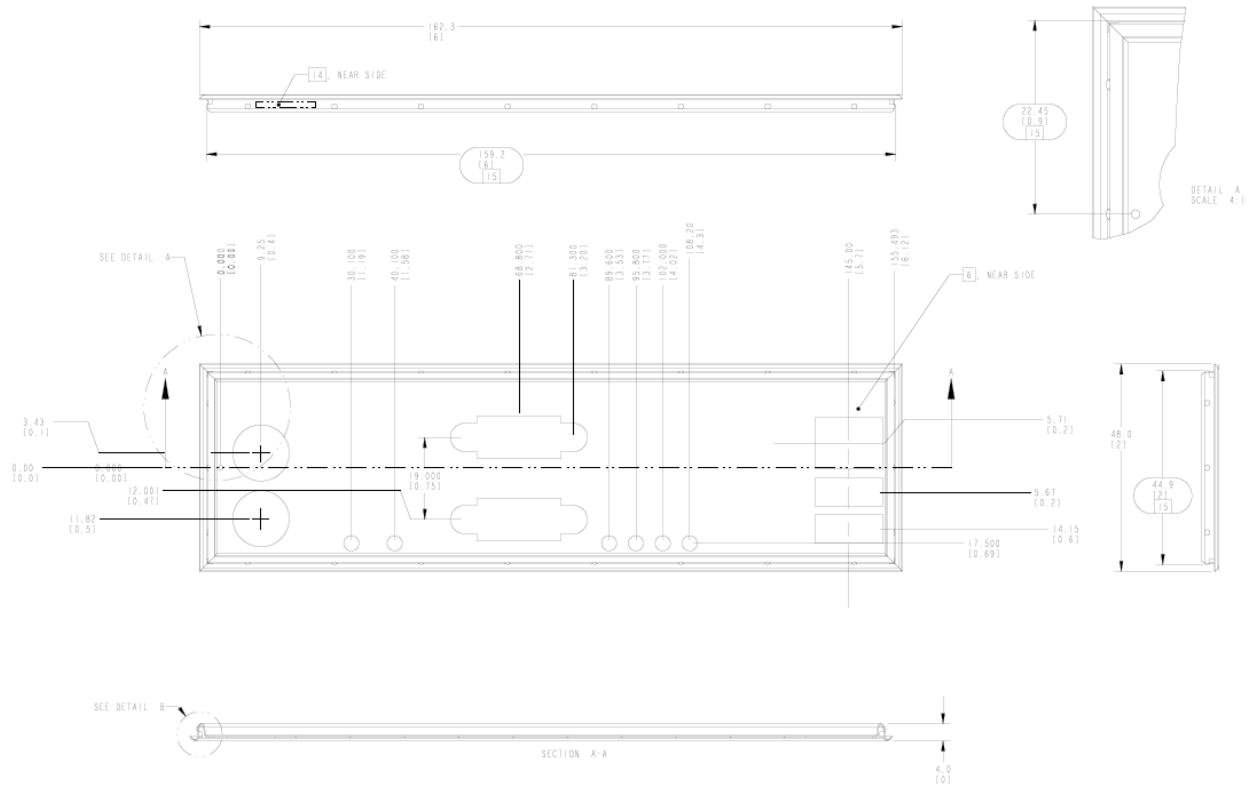

Figure 40. Pedestal Mount I/O Shield Mechanical Drawing for the Intel® Server Board S3200SH-V

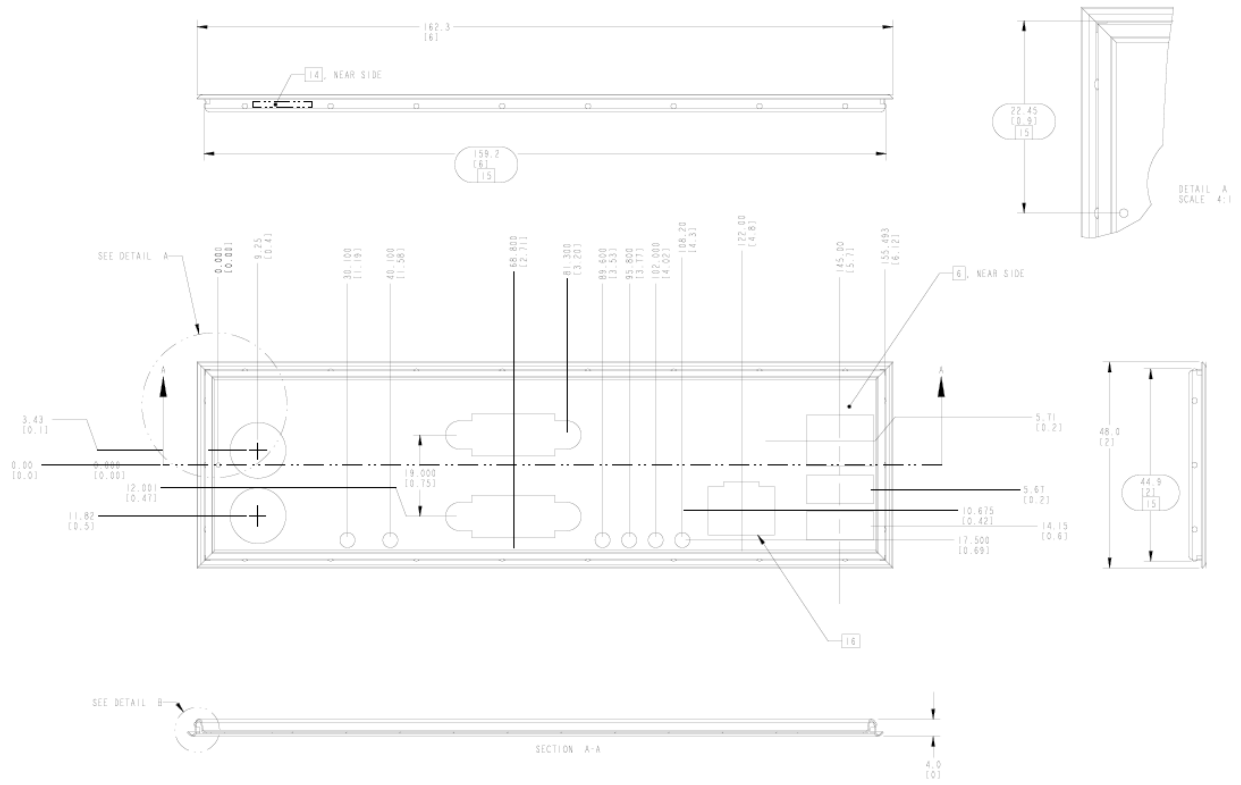

Figure 41. Pedestal Mount I/O Shield Mechanical Drawing for Intel® Server Boards S3200SH-L/S3210SH-LX

9. Hardware Monitoring

9.1 Chassis Intrusion

The server board supports a chassis security feature that detects removal of the chassis cover. For the chassis intrusion circuit to function, the chassis' power supply must be connected to AC power. The security feature uses a mechanical switch on the chassis that attaches to the chassis intrusion connector. When the chassis cover is removed, the mechanical switch is in the open position.

Glossary

This appendix contains important terms used in the preceding chapters. For ease of use, numeric entries are listed first (for example, “82460GX”) with alpha entries following (for example, “AGP 4x”). Acronyms are then entered in their respective place, with non-acronyms following.

Term	Definition
ACPI	Advanced Configuration and Power Interface
ANSI	American National Standards Institute
AP	Application Processor
ASIC	Application Specific Integrated Circuit
ASR	Asynchronous Reset
BEV	Bootstrap Entry Vector
BGA	Ball-grid Array
BIOS	Basic input/output system
BMC	Baseboard Management Controller
Byte	8-bit quantity.
CMOS	In terms of this specification, this describes the PC-AT compatible region of battery-backed 128 bytes of memory, which normally resides on the server board.
DCD	Data Carrier Detect
DIMM	Dual In-Line Memory Module
DMA	Direct Memory Access
DMTF	Distributed Management Task Force
ECC	Error Correcting Code
EMC	Electromagnetic Compatibility
EPS	External Product Specification
ESCD	Extended System Configuration Data
FDC	Floppy Disk Controller
FIFO	First-In, First-Out
FRB	Fault Resilient Booting
FRU	Field replaceable unit
FSB	Front Side Bus
GB	1024 MB
Gbit	1 Gbit
GPIO	General purpose I/O
GUID	Globally Unique ID
Hz	Hertz (1 cycle/second)
HDG	Hardware Design Guide
I2C	Inter-integrated circuit bus
IA	Intel® architecture
ICMB	Intelligent Chassis Management Bus
IERR	Internal error
IMB	Inter Module Bus
IP	Internet Protocol
IPMI	Intelligent Platform Management Interface

Term	Definition
IRQ	Interrupt Request
ITP	In-target probe
KB	1024 bytes
KCS	Keyboard Controller Style
KHz	32.768 KHz
LAN	Local area network
LBA	Logical Block Address
LCD	Liquid crystal display
LPC	Low pin count
LSB	Least Significant Bit
MB	1024 KB
MBE	Multi-Bit Error
Ms	milliseconds
MSB	Most Significant Bit
MTBF	Mean Time Between Failures
Mux	multiplexor
NEBS	Network Equipment Building Systems
NIC	Network Interface Card
NMI	Non-maskable Interrupt
NVRAM	Non-volatile Random Access Memory
OEM	Original equipment manufacturer
Ohm	Unit of electrical resistance
PBGA	Pin Ball Grid Array
PCB	Printed Circuit Board
PECI	Platform Environment Control Interface
PERR	Parity Error
PIO	Programmable I/O
PMB	Private Management Bus
PMC	Platform Management Controller
PME	Power Management Event
PnP	Plug and Play
POST	Power-on Self Test
PWM	Pulse-Width Modulator
RAIDIOS	RAID I/O Steering
RAM	Random Access Memory
RI	Ring Indicate
RISC	Reduced instruction set computing
RMCP	Remote Management Control Protocol
ROM	Read Only Memory
RTC	Real Time Clock
SBE	Single-Bit Error
SCI	System Configuration Interrupt
SDR	Sensor Data Record
SDRAM	Synchronous Dynamic RAM

Term	Definition
SEL	System event log
SERIRQ	Serialized Interrupt Requests
SERR	System Error
SM	Server Management
SMI	Server management interrupt. SMI is the highest priority non-maskable interrupt
SMM	System Management Mode
SMS	System Management Software
SNMP	Simple Network Management Protocol
SPD	Serial Presence Detect
SSI	Server Standards Infrastructure
SSI EEB	Server System Infrastructure Electronic Bay
TPS	Technical Product Specification
UART	Universal asynchronous receiver and transmitter
USB	Universal Serial Bus
VGA	Video Graphic Adapter
VID	Voltage Identification
VRM	Voltage Regulator Module
Word	16-bit quantity
ZCR	Zero Channel RAID

Reference Documents

Refer to the following documents for additional information:

- *Intel® S3200 Server Board Family Datasheet*
- *Intel® 3200 Series Chipset Memory Controller Hub Datasheet.*
- *Intel® ICH9 I/O Controller Hub Datasheet.*