



Intel® Server Board S3420GPLX  
Intel® Server Board S3420GPLC  
Intel® Server Board S3420GPV  
Intel® Server Board S3420GPRX  
Intel® Server System SR1630GP  
Intel® Server System SR1630HGP  
Intel® Server System SR1630GPRX  
Intel® Server System SR1630HGPRX  
Intel® Server Chassis SC5650UP  
Intel® Server Chassis SC5299UP  
Intel® Server Chassis SC5299DP  
Intel® Server Chassis SC5299BRP

## *Spares/Accessories List & Configuration Guide*

A reference guide to assist customers in ordering the necessary components to configure the Intel® Server board S3420GPLX, Intel® Server board S3420GPLC, Intel® Server board S3420GPV, Intel® Server board S3420GPRX, Intel® Server System SR1630GP, Intel® Server System SR1630HGP, Intel® Server System SR1630GPRX, Intel® Server System SR1630HGPRX, Intel® Server Chassis SC5299UP, Intel® Server Chassis SC5299DP, Intel® Server Chassis SC5299BRP and Intel® Server Chassis SC5650UP.



**Rev. 2.0**

**June 2011**

**Enterprise Platforms and Services Marketing**

## Revision History

November '09 – Rev.1.2 – Updated AXXBASICRAIL.

December '09 – Rev.1.3 – Added APP3HSDBKIT.

January '10 – Rev.1.4 – Added S3420GPV product information.

February '10 – Rev.1.5 – Changed MM# for S3420GPLX, S3420GPLC, SR1630GP, SR1630HGP, AXXSATADVROM and add SC5299UP.

March '10 – Rev.1.6 – Added S3420GPRX, SR1630GPRX and SR1630HGPRX product information.

June '10 – Rev.1.7 – Added photos for several accessory parts and typo correction.

September '10 – Rev.1.8 – Added new SAS2.0 modules and spare parts for SC5299DP and SC5299BRP. Added BB3420GPLXSASM product information.

February '11 – Rev.1.9 – Added new IO shield AGPRXIO for S3420GPRX.

June '11 – Rev.2.0 – Modified the bezel ADWBEZBLACK description.

## Disclaimer

INFORMATION IN THIS DOCUMENT IS PROVIDED IN CONNECTION WITH INTEL® PRODUCTS. NO LICENSE, EXPRESS OR IMPLIED, BY ESTOPPEL OR OTHERWISE, TO ANY INTELLECTUAL PROPERTY RIGHTS IS GRANTED BY THIS DOCUMENT. EXCEPT AS PROVIDED IN INTEL'S TERMS AND CONDITIONS OF SALE FOR SUCH PRODUCTS, INTEL ASSUMES NO LIABILITY WHATSOEVER, AND INTEL DISCLAIMS ANY EXPRESS OR IMPLIED WARRANTY, RELATING TO SALE AND/OR USE OF INTEL PRODUCTS INCLUDING LIABILITY OR WARRANTIES RELATING TO FITNESS FOR A PARTICULAR PURPOSE, MERCHANTABILITY, OR INFRINGEMENT OF ANY PATENT, COPYRIGHT OR OTHER INTELLECTUAL PROPERTY RIGHT.

Intel products are not intended for use in medical, life saving, life sustaining applications. Intel may make changes to specifications and product descriptions at any time, without notice.

Intel server boards, server chassis, and processors may contain design defects or errors known as errata, which may cause the product to deviate from published specifications. Current characterized errata are available on request.

Intel, Intel Xeon, Pentium, and the Intel logo are trademarks or registered trademarks of Intel Corporation or its subsidiaries in the United States and other countries.

\*Other names and brands may be claimed as the property of others.

Copyright © 2011, Intel Corporation.

## CONTENTS

CONTENTS.....	3
PRODUCTION CONFIGURATIONS.....	4
<b>1.1 Production Board, Server System and Chassis.....</b>	<b>4</b>
A. PRODUCTION ORDER CODES.....	10
<b>A1. Production Board .....</b>	<b>10</b>
<b>A2. Production Board Accessories .....</b>	<b>11</b>
<b>A3. Production Chassis .....</b>	<b>11</b>
<b>A4. Production Chassis Accessory and Spare .....</b>	<b>13</b>
<b>A5. Production Server System .....</b>	<b>18</b>
<b>A6. Production System SR1630GP, SR1630HGP Accessory and Spare.....</b>	<b>20</b>
<b>A7. Production RAID Accessories (not including BBU).....</b>	<b>23</b>
<b>A8. Production RAID Controller.....</b>	<b>24</b>

## 1.1 Production Board, Server System and Chassis

This section contains information needed to order Production Intel® Server Board S3420GPLX/S3420GPLC/S3420GPV/S3420GPRX, Intel® Server System SR1630GP/SR1630HGP/SR1630GPRX/SR1630HGPRX, Intel® Server Chassis SC5650UP/SC5299UP/SC5299DP/SC5299BRP

### 1. The Production Intel® boxed Server Board S3420GPLX contain the following:

- One Intel® Server Board S3420GPLX
  - Dual Gb Ethernet
  - IPMI 2.0 support
  - Intel® Matrix Storage Technology (SW RAID 0, 1, 10, 5 support)
  - Intel Embedded Server RAID Technology II (SW RAID 0, 1, 10 support)
  - Support AXX4SASMOD and AXXROMBSASMR as optional RAID accessory
  - Support AXXRMM3 as optional Remote Management Module accessory
  - Compatible with Intel® Xeon® processor 3400 series/ Intel® Core™i3/Pentium® G6950
- ATX I/O shield and gasket
- Cables: 2 SATA cables
- RoHS Declaration Documentation
- Attention Document
- Quick Start Guide
- Quick Config Label
- Resource CD with utilities, drivers, documentation and technical information

### 2. The Production Intel® Server Board S3420GPLC contain the following:

- One Intel® Server Board S3420GPLC
  - Dual Gb Ethernet
  - IPMI 2.0 support
  - Intel® Matrix Storage Technology (SW RAID 0, 1, 10, 5 support)
  - Intel® Embedded Server RAID Technology II (SW RAID 0, 1, 10 support)
  - Compatible with Intel® Xeon® processor 3400 series/ Intel® Core™i3/Pentium® G6950
- ATX I/O shield and gasket
- Cables: 2 SATA cables
- RoHS Declaration Documentation
- Attention Document
- Quick Start Guide

- Quick Config Label
- Resource CD with utilities, drivers, documentation and technical information

**3. The Production Intel® Server Board S3420GPV contain the following:**

- One Intel® Server Board S3420GPV
  - Dual Gb Ethernet
  - Onboard Video controller SM712\*
  - Intel® Matrix Storage Technology (SW RAID 0, 1, 10, 5 support)
  - Intel® Embedded Server RAID Technology II (SW RAID 0, 1, 10 support)
  - Compatible with Intel® Xeon® processor 3400 series/ Intel® Core™ i3/Pentium® G6950
- ATX I/O shield and gasket
- Cables: 2 SATA cables
- RoHS Declaration Documentation
- Attention Document
- Quick Start Guide
- Quick Config Label
- Resource CD with utilities, drivers, documentation and technical information

**4. The Production Intel® boxed Server Board S3420GPRX contain the following:**

- One Intel® Server Board S3420GPRX
  - Five GbE onboard NICs
  - IPMI 2.0 support
  - Intel® Matrix Storage Technology (SW RAID 0, 1, 10, 5 support)
  - Intel® Embedded Server RAID Technology II (SW RAID 0, 1, 10 support)
  - Support AXX4SASMOD and AXXROMBSASMR as optional RAID accessory
  - Support AXXRMM3LITE as optional Remote Management Module accessory
  - Compatible with Intel® Xeon® processor 3400 series/ Intel® Core™ i3/Pentium® G6950
- RoHS Declaration Documentation
- Attention Document

**5. The Production OEM 10-packs of Intel® Server Board S3420GPLC contain the following:**

- Compatible with Intel® Xeon® processor 3400 series/ Intel® Core™ i3/Pentium® G6950

**6. The Production OEM 10-packs of Intel® Server Board S3420GPV contain the following:**

- Compatible with Intel® Xeon® processor 3400 series/ Intel® Core™ i3/Pentium® G6950

**7. The Production Intel® Server System SR1630GP contain the following:**

- Intel® Server Board S3420GPLC
- Intel® Server Chassis SR1630, UP based chassis with fixed 350W PFC power supply

- Two fixed cooling blowers with ducting
- Support for up to two fixed hard drives
- Cables (Pre-routed):
  - Front Panel Cable (baseboard header to front panel)
  - USB Cable (USB header to chassis front panel)
  - Two SATA cables
- Basic rack rail kit
- One UP 1U passive heat sink
- Loose part kit including Optical Drive assembly, rack handles and screws, fixed hard drive assembly and screws
- One Low Profile PCIe Gen2 x8 riser
- RoHS Declaration Documentation
- Attention Document
- Quick Start Guide
- Quick reference label
- Resource CD with utilities, drivers, documentation and technical information

**Note:**

- No AC power cords are included.
- AC power cord is included in SR1630GPNA.

**8. The Production Intel® Server System SR1630HGP contain the following:**

- Intel® Server Board S3420GPLC
- Intel® Server Chassis SR1630H, UP based chassis with hot swap drives support
- Support for up to three hot swap hard drives
- One hot swap SATA backplane
  - Cables (Pre-routed):
    - Front Panel Cable (baseboard header to front panel)
    - USB Cable (USB header to chassis front panel)
    - Three SATA cables
    - SGPIO cable
- Basic rack rail kit
- One UP 1U passive heat sink
- Loose part kit including Optical Drive assembly, rack handles and screws, air baffle, and screws
- One Low Profile PCIe Gen2 x8 riser
- RoHS Declaration Documentation
- Attention Document
- Quick Start Guide

- Quick reference label
- Resource CD with utilities, drivers, documentation and technical information

**Note:**

- No AC power cords are included.
- AC power cord is included in SR1630HGPNA.

**9. The Production Intel® Server System SR1630GPRX contain the following:**

- Intel® Server Board S3420GPRX
- Intel® Server Chassis SR1630, UP based chassis with fixed high efficiency 350W PFC power supply
- Two fixed cooling blowers with ducting
- Support for up to two fixed hard drives
  - Cables (Pre-routed):
    - Front Panel Cable (baseboard header to front panel)
    - USB Cable (USB header to chassis front panel)
    - Two SATA cables
    - Basic rack rail kit
- One UP 1U passive heat sink
- Loose part kit including Optical Drive assembly, rack handles and screws, fixed hard drive assembly and screws
- One Low Profile PCIe Gen2 x8 riser
- RoHS Declaration Documentation
- Attention Document

**Note:**

- No AC power cords are included.
- AC power cord is included in SR1630GPRXNA.

**10. The Production Intel® Server System SR1630HGPRX contain the following:**

- Intel® Server Board S3420GPRX
- Intel® Server Chassis SR1630H, UP based chassis with hot swap drives support and fixed high efficiency 350W PFC power supply
- Two fixed cooling blowers with ducting
- One fixed system fan
- Support for up to three hot swap hard drives
- One hot swap SATA backplane
- Cables (Pre-routed):
  - Front Panel Cable (baseboard header to front panel)
  - USB Cable (USB header to chassis front panel)
  - Three SATA cables

- SGPIO cable
- Basic rack rail kit
- One UP 1U passive heat sink
- Loose part kit including Optical Drive assembly, rack handles and screws, and screws
- One Low Profile PCIe Gen2 x8 riser
- RoHS Declaration Documentation
- Attention Document

**Note:**

- No AC power cords are included.
- AC power cord is included in SR1630HGPRXNA.

**11. The Production Intel® Server Chassis SC5650UP base KDK is compatible with the Intel® Server Boards S3420GPLX and S3420GPLC. It includes:**

- High Efficiency 400W PFC power supply
- One Rear system fan with air-duct and one HDD fan
- PCI card guard
- Support for up to six tool-free non hot-swap 3.5" SATA hard drives. Upgradeable to hot swap SAS/SATA 6-drive bay.

**Note:** Check the Power budget spreadsheet for supportable hard drive, memory and PCI configurations.

- Cables (Pre-routed):
  - Front Panel Cable (baseboard header to front panel)
  - USB Cable (USB header to chassis front panel)
  - Loose part kit including screws for baseboard and Optical Drive, Fan guard, foot assembly and tie mount
  - Chassis intrusion switch assembly
- 5 Bumpers for installing Intel® Server Boards S3420GPLX and S3420GPLC
- RoHS Declaration Documentation
- Attention Document
- Quick Start Guide

**Note:**

- No AC power cords are included.
- AC power cord is included in SC5650UPNA.

**12. The production Intel® Server Chassis SC5299DP base KDK is compatible with the Intel® Server Boards S3420GPLX and S3420GPLC. It includes:**

- Non-redundant 550-W PFC power supply
  - One non-redundant cooling fan
  - Support for six, tool-free non-hot-swap hard drives. Upgradeable to hot swap SAS/SATA 6-drive bay.
- Note:** Check the Power budget spreadsheet for supportable hard drive, memory, and PCI configurations.



- Cables (one each):
  - Front Panel Cable (USB header to chassis front panel)
  - USB Cable (USB header to chassis front panel)
  - AC power cord is included in SC5299DPNA
- Chassis intrusion switch assembly
- The chassis is designed to work with the boxed Intel® Xeon® processor 3400 sequence or Intel® Core™ processor i3 or Intel® Pentium® processor G6950 using an active heat-sink.

**13. The production Intel® Server Chassis SC5299BRP base KDK is compatible with the Intel® Server Boards S3420GPLX and S3420GPLC. It includes:**

- Redundant (1+0) 650-W PFC power supply with dual-line cord support (full redundancy requires an additional 650-W module, which you must purchase separately)
- One non-redundant cooling fan
- Support for six, tool-free non-hot-swap hard drives. Upgradeable to hot swap SAS/SATA 6-drive bay.
- Cables (one each):
  - Front Panel Cable (USB header to chassis front panel)
  - USB Cable (USB header to chassis front panel)
  - AC power cord is included in SC5299BRPNA
- Chassis intrusion switch assembly

The chassis is designed to work with the boxed Intel® Xeon® processor 3400 sequence or Intel® Core™ processor i3 or Intel® Pentium® processor G6950 using an active heat sink.







**14. The Production Intel® Server Chassis SC5299UP base KDK is compatible with the Intel® Server Board S3420GPV. It includes:**



- One fixed 420W power supply
- One chassis fan
- One PSU fan
- Support for six, tool-free non-hot-swap hard drives. Upgradeable to hot swap SAS/SATA 6-drive bay
- Cables (one each):
  - Front Panel Cable (USB header to chassis front panel)
  - USB Cable (USB header to chassis front panel)
  - AC power cord is included in SC5299UPNA

The chassis is designed to work with the boxed Intel® Xeon® processor 3400 sequence or Intel® Core™ processor i3 or Intel® Pentium® processor G6950 using an active heat sink.

## A. PRODUCTION ORDER CODES



### A1. Production Board

Picture	Product Code MM# UPC	MOQ	Description
	S3420GPLX 907525 00735858211802	5	Production Intel® Server Board S3420GPLX (boxed version), PCIe/PCI-X/PCI support, six SATA ports and Dual GbE. Support Intel SAS module and RMM3 module. Compatible with Intel® Xeon® processor 3400 series/ Intel® Core™ i3/Pentium® G6950.
	S3420GPLC 907524 00735858211819	5	Production Intel® Server Board S3420GPLC (boxed version), PCIe/PCI-X/PCI support, six SATA ports and Dual GbE. Compatible with Intel® Xeon® processor 3400 series/ Intel® Core™ i3/Pentium® G6950.
	BB3420GPLC 907526 00735858211826	10	Production Intel® Server Board S3420GPLC (OEM 10-pack version), PCIe/PCI-X/PCI support, six SATA ports and Dual GbE. Compatible with Intel® Xeon® processor 3400 series/ Intel® Core™ processor i3-500 series/Pentium® processor G6950.
	S3420GPV 902726 00735858213851	5	Production Intel® Server Board S3420GPV (boxed version), PCIe/PCI-X/PCI support, six SATA ports and Dual GbE. Compatible with Intel® Xeon® processor 3400 series/ Intel® Core™ processor i3-500 series/Pentium® processor G6950.
	BB3420GPV 902728 00735858213868	10	Production Intel® Server Board S3420GPV (OEM 10-pack version), PCIe/PCI-X/PCI support, six SATA ports and Dual GbE. Compatible with Intel® Xeon® processor 3400 series/ Intel® Core™ processor i3-500 series/Pentium® processor G6950.
	S3420GPRX 905452 00735858214841	5	The production S3420GPRX board (boxed version), S3420GPRX is rack chassis optimized, that contains six SATA ports, 5 onboard GbE. It supports Intel SAS module and RMM3 Lite module. Compatible with Intel® Xeon® processor 3400 series/ Intel® Core™ processor i3-500 series /Pentium® processor G6950.  <b>Note:</b> S3420GPRX is rack chassis optimized. Order AGPRXIO I/O shield for the pedestal chassis or the 3 <sup>rd</sup> party rack chassis.

Picture	Product Code MM# UPC	MOQ	Description
 <p>plus</p> 	BB3420GPLXSASM 909787 00735858216456	10	Production Intel® Server Board S3420GPLX + Intel® SAS Entry RAID Module AXX4SASMOD (OEM 10-pack version), PCIe/PCI-X/PCI support, six SATA ports and Dual GbE. Support Intel SAS module and RMM3 module. Compatible with Intel® Xeon® processor 3400 series/ Intel® Core™ processor i3-500 series/Pentium® processor G6950.

MOQ = Minimum Order Quantity.







### A2. Production Board Accessories

Picture	Product Code MM # UPC	MOQ	Description
	AXXTIO 901685 00735858207683	50	I/O Shield for Intel® Server Boards S3420GPLX, S3420GPLC and S3420GPV.
	AGPRXIO 914235 00735858220200	5	I/O Shield for Intel® Server Boards S3420GPRX

MOQ = Minimum Order Quantity.





### A3. Production Chassis



Picture	Product Code MM# UPC	MOQ	Description
	SC5650UP 902737 00735858211833	1	Intel® Server Chassis SC5650UP with 400W fixed PSU, two fixed chassis fans with ducting, rackable with optional rack kit, supports up to six fixed drives, upgradeable to six Hot-Swap drives (SAS or SATA). <b>Check the Power budget spreadsheet for supportable hard drive, memory and PCI configurations.</b> Supports S3420GPLX and S3420GPLC. Supports up to 95W processor. No power cord or heat sinks included.









Picture	Product Code MM# UPC	MOQ	Description
	SC5650UPNA 902738 00735858211840	1	Same as Intel Server Chassis SC5650UP with North American power cord. No heat sinks included.
	SC5299UP 892757 00735858197526	1	Intel® Server Chassis SC5299UP, fixed 420W PSU, rackable, new tool less features, one chassis fan, one PSU fan, supports up to six tool-free cabled drives or Hotswap drives, without power cord. Supports S3420GPV. Supports up to 95W processor.
	SC5299UPNA 893064 00735858197533	1	Same as Intel® Server Chassis SC5299UP but with North American power cord.
	SC5299BRP 877864 00735858180344	1	SC5299BRP Base Redundant Power 650-W (optional, second PSU module is required for redundancy), one chassis fan, rackable with optional rack kit. Supports up to six fixed drives, upgradeable to six Hot-Swap drives (SAS or SATA). Supports Intel® Server Board S3420GPLC and S3420GPLX. No power cord included.
	SC5299BRPNA 881190 00735858182942	1	Same as SC5299BRP with North American power cord.
	SC5299DP 877875 00735858180320	1	SC5299DP with 550-W fixed PSU, one chassis fan, rackable with optional rack kit, supports up to six fixed drives, upgradeable to six Hot-Swap drives (SAS or SATA). <b>Check the Power budget spreadsheet for supportable hard drive, memory, and PCI configurations.</b> Supports Intel® Server Board S3420GPLC and Intel® Server Board S3420GPLX. No power cord included.
	SC5299DPNA 880985 00735858182959	1	Same as SC5299DP with North American power cord.







MOQ = Minimum Order Quantity.

## A4. Production Chassis Accessory and Spare



Picture	Product Code MM# UPC	MOQ	Description
	AXX6DRV3GEXP 877235 00735858180283	1	6-drive hot-swap, expander SATA/SAS backplane assembly cage kit for Intel® Server Chassis SC5600/SC5299 family. Requires two SAS ports from SAS personality module or RAID card and is compatible with SAS or SATA 3.5" hard drives. Includes: backplane board, six drive carriers, 2 Data cables, 6-drive bay, IPMB cable, common installation guide, SATA/SAS configuration label.
	AXX6DRV3GR 900405 00735858207638	1	6-drive hot-swap non-expanded SATA/SAS backplane assembly cage kit for Intel® Server Chassis SC5600/SC5299 family. Requires 6 SAS ports from RAID card for SAS (or SATA) 3.5" hard drive support or six SATA ports from baseboard or RAID card for SATA 3.5" hard drive support. Includes: Backplane board, 6 drive carriers, six data cables, 6-drive bay, IPMB cable, SES cable and SGPIO cable, common installation guide, SATA/SAS configuration label.
	AXX6DRV3G 877237 00735858180283	1	Intel® Server Chassis SC5299-E 6-drive hot swap non- expanded SATA/SAS supported backplane assembly. Compatible with either SAS or SATA 3.5-inch hard drives.  Includes: Board, six drive carriers, six Data cables, 6-drive bay, IPMB cable, SES cable and SGPIO cable, common installation guide, and SATA/SAS configuration label.
	AXXRMM3 900961 00735858206570	1	Intel® Remote Management Module 3 for Intel® Server Board S3420GPLX.
	AXXRMM3LITE 905659 00735858214469	1	Intel® Remote Management Module 3 Lite for Intel® Server Board S3420GPRX, Intel® Server System SR1630GPRX and SR1630HGPRX.

Picture	Product Code MM# UPC	MOQ	Description
	APPTHSDBKIT 901181 00735858207676	1	Hot-swap drive cooling and mounting Kit for Intel® Server Chassis SC5650, Includes one fan holder and six Hot-swap cage brackets. This mounting kit is required when using 6-bay Hot-swap Hard Disk Cage AXX6DRV3GR in SC5650 Chassis family.
	APP3HSDBKIT 882456 00735858177450	1	Hot-swap drive mounting Kit for Intel Server Chassis SC5650/SC5299 family, Includes one cooling fan, one fan holder and two Hot-swap cage brackets.  <b>Note:</b> This mounting kit is required when using 6-bay Hot-swap Hard Disk Cage in SC5299/SC5650 Chassis. This kit should be used with <b>AXX6DRV3GEXP</b> .
	APP3RACKIT 882457 00735858177375	1	Rack conversion kit for Intel® Server Chassis SC5650/SC5299 family. Includes rack rails and hardware for rack installation.
	APP3STDBEZEL 871862 00735858177474	1	Spare bezel with door for Intel® Server Chassis SC5650/SC5299 family.
	FPPTFANKIT4W 901182 00735858207713	1	4 wire fan kit for Intel® Server Chassis SC5650 family. Includes (1) 4 wire PCI Fan(120mm) & (2) 4 wire rear fan(120mm) & (1) 4 wire HDD fan(92mm).
	FPPTUPPMKIT 903261 00735858211857	1	Chassis Preventative Maintenance Kit for Intel® Server Chassis SC5650UP. Includes (2) Hard Drive Bay Lockers with Screws and Spring, (1) SC5650UP Air Duct, (1) Intrusion Switch Assembly, (1) USB Cable, (1) Rear 120mm Fan with Fan Holder and Screws, (1) 92mm Fan with Holder and Screws, (1) Full-length PCI Card Guide, (1) Adapter Plate with Screws for Fixed Power Supply, (1) Fixed Power supply tool-less locker, (4) Chassis Feet, , (1) Fixed HDD Fan Plate.
	FXXPPTFPBRD 901360 00735858207737	1	Spare front panel board for Intel® Server Chassis SC5650 family.
	FXXIPMBCBL 878135 00735858180085	10	Spare IPMB cables

Picture	Product Code MM# UPC	MOQ	Description
	FXXSESCBL 877945 00735858180092	10	Spare SES cables
	FXXSGPIOCBL 877944 00735858180108	10	Spare SGPIO cables
	AXXRJ45DB92 903041 00735858155212	1	Contains two serial cable converter dongles (RJ45 to DB9) one for DSD and one for DCD (modem). The kit also includes one serial ribbon cable for cabling 2nd serial port from the baseboard.  <b>Note:</b> This ribbon cable is not used with the Intel® Server Chassis SC5600/SC5650 family.
	FXX6DRV3GRBRD 901337 00735858206396	1	Spare board for AXX6DRV3GR (6 drive backplane without an expander).
	FXX6DRV3GEXPBRD 879632 00735858180948	1	Spare board for AXX6DRV3GEXP (6 drive backplane with an expander).
	FXX10DVCARBLK 880265 00735858181938	10	Hot swap drive carrier spare with black baffle.
	FPWRCABLENA 879287 00735858180740	1	Spare North America Power cable for Intel® Server Chassis SC5650, SC5299 family.
	FXX400PSU 903259 00735858211864	1	Intel® Server Chassis SC5650UP 400W HE PSU
	AXX25DRVADPTR 904083 00735858211567	10	2.5" Hard Disk Drive Carrier Kit, include ten 2.5" drive carriers and installation guide. The 2.5" HDD carrier is for installing 2.5" SAS, SATA, or SSD into 3.5" hot-swap hard disk drive bay. See compatible Intel® chassis and systems at: <a href="http://www.intel.com/support/motherboards/server/sb/CS-030726.htm">http://www.intel.com/support/motherboards/server/sb/CS-030726.htm</a>



Picture	Product Code MM# UPC	MOQ	Description
	FXX420WPSU 880743 00735858179140	1	SC5299UP 420W power supply spare
	APP4650WPSU 878018 00735858180375	1	2 <sup>nd</sup> Redundant 650-W PSU for Intel® Server Chassis SC5299BRP. Two modules are required for PSU redundancy.
	AXXGBIOMOD 913137 00735858184779	1	External Dual-port GbE NIC module for Intel® Server Board S3420GPRX.
	AXX4GBIOMOD2 901359 735858206532	1	Quad port Gigabit Ethernet Intel® I/O Expansion Module based on the Intel® 82576EB Gigabit Ethernet Controller for Intel® Server Board S3420GPRX.
	AXXSASIOMOD 902300 00735858184786	1	External Quad-port SAS module for Intel® Server Board S3420GPRX.
	FPP4550WPSU 878012 00735858180351	1	Spare 550-W PSU for Intel® Server Chassis SC5299DP.
	FPP4BRPCAGE 878014 00735858180368	1	Spare Intel® Server Chassis SC5299BRP redundant power supply cage. Also used to upgrade Intel® server chassis SC5299DP to redundant power configuration. Requires 1 (or 2) APP4650WPSU to complete upgrade. Includes PDB and filler (for empty module when only one module is installed). For instructions, refer to the TPS.







Picture	Product Code MM# UPC	MOQ	Description
	FPP4FANKIT4W  877984  00735858180405	1	Intel® Server Chassis SC5299-E 4 wire fan kit. Includes (1) 92mm for SC5299WS and (1) 120mm fan for SC5299-E
N/A	FPP4PMKIT  878019  00735858180382	1	Intel® Server Chassis SC5299-E Preventive maintenance kit includes the following: (2) Plastic slides from fixed drive bay (1) CPU Duct (1) Intrusion Switch Assembly (1) USB Cable (1) Plastic fan bracket (1) Front Panel board (new for PP4) (1) Front panel cable (24-pin for PP4) (1) Front Panel Board (new for PP4) (1) Power supply adapter Plate (for fixed PS) (1) Power supply tool-less PS lock (4) Chassis feet (1) Memory PP4 duct (1) 120 MM Fan (4-wire PP4 new fan) (1) 92 MM fan (4-wire Intel® Server Chassis SC5299E) (1) Fixed HDD Fan Plate (1) 92 MM plastic Fan Bracket
N/A	FXXPP4FPBRD  877393  00735858180399	1	Spare front panel for Intel® Server Chassis SC5299-E chassis.
	PWRCABLEUS  816324  00735858162883	1	Spare RoHS compliant North America power cable.

**MOQ** = Minimum Order Quantity.

## A5. Production Server System



Picture	Product Code MM # UPC	MOQ	Description
	SR1630GP 907506 00735858211871	1	Production Intel® Server System SR1630GP (1U Intel Server Chassis SR1630 + Intel® Server Board S3420GPLC), fixed 350W PSU, supports up to two fixed HDs, two SATA cables, one USB cable, one front panel cable, 1U passive heatsink, basic rack rail, one PCI-E x8 riser card, without power cord.
	SR1630HGP 907517 00735858211895	1	Production Intel® Server System SR1630HGP includes S3420GPLC board, 1U chassis with three hot swap hard drive carriers, 1U passive heatsink, 350W power supply, three SATA cables, one USB cable, one front panel cable, one SGPIO cable, one passive backplane, basic rack rail, one PCI-E x8 riser card, without power cord.
	SR1630GPNA 905769 00735858211888	1	Same as Intel® Server System SR1630GP with North American power cord.





Picture	Product Code MM # UPC	MOQ	Description
	SR1630HGPNA 905819 00735858211901	1	Same as Intel® Server System SR1630HGP with North American power cord.
	SR1630GPRX 905453 00735858214674	1	The production SR1630GPRX bare bone system, (1U Intel Server Chassis SR1630 + Intel® server board S3420GPRX), fixed 350W PSU, supports up to two fixed HDs, two SATA cables, one USB cable, one front panel cable, 1U passive heatsink, basic rack rail, 1 PCI-E x8 riser card, without power cord).
	SR1630HGPRX 905454 00735858214681	1	The production SR1630HGPRX bare bone system (1U Intel Server Chassis SR1630H + S3420GPRX board, three hot swap hard drive carriers, 1U passive heatsink,, 350W power supply, three SATA cables, one USB cable, one front panel cable, one SGPIO cable, one passive backplane, basic rack rail, 1 PCI-E x8 riser card, without power cord).



Picture	Product Code MM # UPC	MOQ	Description
	SR1630GPRXNA 904388 00735858214704	1	The production SR1630GPRX bare bone system, (1U Intel Server Chassis SR1630 + Intel® server board S3420GPRX), fixed 350W PSU, supports up to 2 fixed HDs, two SATA cables, one USB cables, one front panel cable, 1U passive heatsink, basic rack rail, one PCI-E x8 riser card with American power cord
	SR1630HGPRXNA 904504 00735858214698	1	The production SR1630HGPRX bare bone system (1U Intel Server Chassis SR1630H + S3420GPRX board, three hot swap hard drive carriers, 1U passive heatsink,, 350W power supply, three SATA cables, one USB cable, one front panel cable, one SGPIO cable, one passive backplane, basic rack rail, one PCI-E x8 riser card, without power cord), with American power cord.

MOQ = Minimum Order Quantity.

## A6. Production System SR1630GP, SR1630HGP Accessory and Spare





Picture	Product Code MM # UPC	MOQ	Description
	AHJBEZBLACK 888348 00735858192163	10	SR1630GP 1U Bezel (Black) for fixed SKU
	ADWBEZBLACK 865064 00735858169110	10	1U Bezel (Black) is for Intel(R) Server System SR1630HGP hotswap SKU only.  <b>Note:</b> For Intel(R) Server System SR1630HGPRX, the bezel ADWBEZBLACK will not allow LED indicators to align properly.

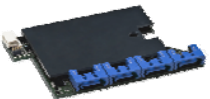

Picture	Product Code MM # UPC	MOQ	Description
	AXXBRACKETS 863262 00735858168618	1	Fixed mount bracket kit
	AXXBASICRAIL 881096 00735858184748	1	Basic Slide Rail Kit <b>Note:</b> Does not support Cable Management Arm(CMA)
	AXXSATADVROM 906872 00735858197663	1	SATA Slim-line DVD
	AXXSATADVDRWROM 906873 00735858197670	1	SATA Slim-line DVD re-writeable
	FPWRCABLENA 879287 00735858181129	1	North American power cable
	AHJTPCIERISER 900772 00735858208130	1	SR1630GP/SR1630HGP/SR1630GPRX/SR1630HGP RX Low Profile half-length PCIe2 x8 riser, 5 pcs in one package.
	FHJ350WPS 897194 00735858211925	1	Spare 350W power supply for SR1630GP/SR1630HGP.
	FHJT350HEPS 905480 00735858214711	1	350W PSU for SR1630GPRX/SR1630HGPRX.

Picture	Product Code MM # UPC	MOQ	Description
	FHJTBLOWER  900770  00735858208154	1	SR1630GP/SR1630HGP/SR1630GPRX/SR1630HGP RX blower spare kit.
N/A	FSR1530BPSATA  887408  735858191111		Spare SATA/SAS backplane for SR1630HGP and SR1630HGPRX.
	FHJTUPPMKIT  903262  00735858211918	1	<p>SR1630GP Preventative Maintenance Kit.</p> <p>Kit includes (1) SR1630GP front panel assembly, (1) SR1630HGP front panel assembly, CD-ROM brackets, (1) SR1630GP Air Duct, (1) SR1630HGP Air Duct, (1) HJ-Fix cable kit, (1) HJ-HS cable kit, and screws (1) HJ-Fix PCI bracket assembly (1) HJ-HS PCI bracket assembly.</p> <p>HJ-Fix cable kit includes: (2) SATA cables, (1) FP cable, (1) FP USB cable.</p> <p>HJ-HS cable kit includes: (3) SATA cables, (1) FP cable, (1) FP USB cable, (1) SGPIO cable.</p> <p><b>Note:</b> Only cable can be used on SR1630GPRX/SR1630HGPRX.</p>
	FHJTRXPMKIT  905456  00735858214728	1	SR1630HGPRX front panel and fan spare parts kit and SR1630GPRX front panel.

**MOQ** = Minimum Order Quantity.

## A7. Production RAID Accessories (not including BBU)

Picture	Product Code  MM#  UPC	MOQ	Description
	AXX4SASMOD  900946  00735858206372	1	Intel® SAS Entry RAID Module AXX4SASMOD provides 4 port pass through SAS, entry-level RAID 0/1/1E, and optional host RAID 5: Includes one AXX4SASMOD module card; one snap standoffs, four SAS/SATA cables, Configuration Label and Quick Installation Guide.  <b>Note:</b> The module only supports the S3420GPLX and S3420GPRX.
	AXXROMBSASMR  901641  00735858208017	1	Intel® Integrated RAID Module ROMBSASMR provides 4 port full featured SAS/SATA RAID 0, 1, 5, 6 and striping capability for spans 10, 50, 60. 128 MB cache. Up to 16 SAS/SATA HDDs with expander enclosures. No PCI-E slot used. Optional backup battery AXXRSBBU3 should be ordered separately.  <b>Note:</b> The module only supports the S3420GPLX and S3420GPRX.
	AXXRAKSW5  878958  00735858181860	5	Intel® RAID Activation Key AXXRAKSW5 enables SAS Host-based RAID 5 with AXX4SASMOD.
	AXXRSBBU3  900954  00735858181853	1	Intel® RAID Smart Battery AXXRSBBU3, optional battery back up for use with AXXROMBSASMR, AXXRAK18E and SRCSAS144E. RoHS Compliant.
	AXXRMS2AF080  907853  00735858215732	5	Intel® Integrated RAID Module SRMS2AF080 provides 8 port entry-level SAS-2/6Gbps RAID 0,1, 5 and striping capability for spans 10, 50. Includes cables. No BBU option.

Picture	Product Code MM# UPC	MOQ	Description
	AXXRMS2AF040 907854 00735858215756	5	Intel® Integrated RAID Module SRMS2AF040 provides 4 port entry-level SAS-2/6Gbps RAID 0,1, 5 and striping capability for spans 10, 50. Includes cables. No BBU option.
	AXXRMS2LL080 907855 00735858215749	5	Intel® Integrated RAID Module SRMS2LL080 provides 8 port basic RAID 0/1/1E and JBOD mode. Includes cables. No BBU option.
	AXXRMS2LL040 907856 00735858215763	5	Intel® Integrated RAID Module SRMS2LL040 provides 4 port basic RAID 0/1/1E and JBOD mode. Includes cables. No BBU option



**MOQ** = Minimum Order Quantity.

## A8. Production RAID Controller

Picture	Product Code MM # UPC	MOQ	Description
	SRCSASPH16I 896897 00735858201339	5	Intel® RAID Controller SRCAS16PHI - PCIe x8, 16P SAS RAID Controller, 256MB with 667MHz memory embedded. Compatible in SC5650UP, SC5299UP/DP/BRP chassis.  Battery Back Up not supported in the SR1630GP, SR1630HGP, SR1630GPRX and SR1630HGPRX system. Internal connectors only support SATA drive in the SR1630GP, SR1630HGP, SR1630GPRX and SR1630HGPRX system.

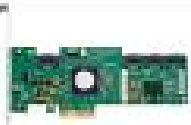

Picture	Product Code MM # UPC	MOQ	Description
	SRCSASJV 892602 00735858196444	5	Intel® RAID Controller SRCSASJV - PCIe x8, 8P SAS RAID Controller with Mux (ports can be configured as internal or external), ships with 512MB DIMM, supports up to 1GB ECC 667MHz DDR2 mini-DIMM. Compatible in SC5650UP, SC5299UP/DP/BRP chassis.  Battery Back Up not supported in the SR1630GP, SR1630HGP, SR1630GPRX and SR1630HGPRX system. Internal connectors only support SATA drive in the SR1630GP, SR1630HGP, SR1630GPRX and SR1630HGPRX system.
	SRCSASBB8I 896943 00735858201346	5	Intel® RAID Controller SRCSASBB8I - PCIe x8, 8P SAS RAID Controller, 256MB embedded memory, MD2 Low Profile, half length form factor. Compatible in SC5650UP, SC5299UP/DP/BRP chassis and SR1630GP, SR1630GPRX, SR1630HGP, SR1630HGPRX system.  Internal connectors only support SATA drive in the SR1630GP, SR1630HGP, SR1630GPRX and SR1630HGPRX system.
	SRCSASRB 892598 00735858196437	5	Intel® RAID Controller SRCSASRB - PCIe x4, 8P SAS RAID Controller, and 256 MB embedded memory. Compatible with SC5650UP, SC5299UP/DP/BRP chassis.  Battery Back Up not supported in the SR1630GP, SR1630HGP, SR1630GPRX and SR1630HGPRX system. Internal connectors only support SATA drive in the SR1630GP, SR1630HGP, SR1630GPRX and SR1630HGPRX system.
	SRCSATAWB 892456 00735858196420	5	Intel® RAID Controller SRCSATAWB - PCIe x4, 8 port SATA RAID Controller, 128MB embedded memory, 16 physical devices, >8 requires expander backplane. Compatible in SC5650UP, SC5299UP/DP/BRP chassis.  Battery Back Up not supported in the SR1630GP, SR1630HGP, SR1630GPRX and SR1630HGPRX system. Internal connectors only support SATA drive in the SR1630GP, SR1630HGP, SR1630GPRX and SR1630HGPRX system.
	SRCSASLS4I 896952 00735858201353	5	Intel® RAID Controller SRCSASLS4I - PCIe x8, 4P SAS RAID Controller, 128MB embedded memory, MD2 Low Profile, half length form factor. Compatible in SC5650UP, SC5299UP/DP/BRP chassis and SR1630GP, SR1630GPRX, SR1630HGP and SR1630HGPRX.  <b>Note:</b> To use in SR1630GP/GPRX/HGP/HGPRX system battery (BBU) needs to be removed due to thermal

Picture	Product Code MM # UPC	MOQ	Description
			<p>limitation. Internal connectors only support SATA drive in the SR1630GP, SR1630HGP, SR1630GPRX and SR1630HGPRX system.</p>
	<p>SASMF8I 896960 00735858201360</p>	<p>5</p>	<p>Intel® RAID Controller SASMF8I - PCIe x4, 8P SAS Controller with Intel Embedded Server RAID technology, Low Profile, half length form factor. Compatible in SC5650UP, SC5299UP/DP/BRP chassis and SR1630GP, SR1630GPRX, SR1630HGP and SR1630HGPRX.</p> <p><b>Note:</b> Internal connectors only support SATA drives in the system SR1630GP/GPRX/HGP/HGPRX.</p>
	<p>SASUC8I 900176 00735858205115</p>	<p>5</p>	<p>Intel® RAID Controller SASUC8I - PCIe x8, 8P SAS Controller with entry-level HW RAID 0/1/1E/10E, low profile, half-length MD2 compliant form factor. Compatible in SC5650UP, SC5299UP/DP/BRP chassis and SR1630GP, SR1630GPRX, SR1630HGP and SR1630HGPRX.</p> <p><b>Note:</b> Internal connectors only support SATA drives in the system SR1630GP/GPRX/HGP/HGPRX.</p>
	<p>SASWT4I 900267 00735858205108</p>	<p>5</p>	<p>Intel® RAID Controller SASWT4I - PCIe x4, 4P SAS Controller with entry-level HW RAID 0/1/1E/10E, low profile, half-length MD2 compliant form factor. Compatible in SC5650UP, SC5299UP/DP/BRP chassis and SR1630GP, SR1630GPRX, SR1630HGP and SR1630HGPRX.</p> <p><b>Note:</b> Internal connectors only support SATA drives in the system SR1630GP/GPRX/HGP/HGPRX.</p>

**MOQ** = Minimum Order Quantity