

Intel® Server System SR1560SF

Technical Product Specification

Intel order number D92959-006



Revision 1.2

May 2010

Enterprise Platforms and Services Marketing

Revision History

Date	Revision Number	Modifications
April 2007	0.5	Preliminary – First External Release
May 2007	0.9	Preliminary – Second External Release: <ul style="list-style-type: none"> - Removed all references to LCP - Updated diagrams - Updated section describing Platform Control and memory throttling - Updated baseboard feature set table - Added sections describing Memory Subsystem
August 2007	0.95	Made product name changes to references of chipset and server board Added Introduction Chapter Product Overview Chapter completely redone <ul style="list-style-type: none"> o Integrated server board overview material o Added supported processor list o Added top-down photographs of both system SKUs Removed Chapter describing Platform Control (See Server Board TPS) Removed Chapter describing Server Board features (See Server Board TPS) Updated DIMM Slot blank requirements Added Jumper Block Settings and Usage Appendix Updated Reference Docs Section Updated Glossary Section
September 2007	1.0	Updated the TPS
November 2008	1.1	Updated supported processor list Updated supported slide rail option Updated descriptions for backplane board
May 2010	1.2	Deleted CCC and CNCA.

Disclaimers

Information in this document is provided in connection with Intel® products. No license, express or implied, by estoppel or otherwise, to any intellectual property rights is granted by this document. Except as provided in Intel's Terms and Conditions of Sale for such products, Intel assumes no liability whatsoever, and Intel disclaims any express or implied warranty, relating to sale and/or use of Intel products including liability or warranties relating to fitness for a particular purpose, merchantability, or infringement of any patent, copyright or other intellectual property right. Intel products are not intended for use in medical, life saving, or life sustaining applications. Intel may make changes to specifications and product descriptions at any time, without notice.

Designers must not rely on the absence or characteristics of any features or instructions marked "reserved" or "undefined." Intel reserves these for future definition and shall have no responsibility whatsoever for conflicts or incompatibilities arising from future changes to them.

The Intel® Server System SR1560SF may contain design defects or errors known as errata which may cause the product to deviate from published specifications. Current characterized errata are available on request.

This document and the software described in it is furnished under license and may only be used or copied in accordance with the terms of the license. The information in this manual is furnished for informational use only, is subject to change without notice, and should not be construed as a commitment by Intel Corporation. Intel Corporation assumes no responsibility or liability for any errors or inaccuracies that may appear in this document or any software that may be provided in association with this document.

Except as permitted by such license, no part of this document may be reproduced, stored in a retrieval system, or transmitted in any form or by any means without the express written consent of Intel Corporation.

Intel, Pentium and Xeon are trademarks or registered trademarks of Intel Corporation.

*Other brands and names may be claimed as the property of others.

Copyright © Intel Corporation 2008. Portions Copyright ® 2005-2010 by LSI Corporation*.

Table of Contents

1. Introduction	1
1.1 Chapter Outline.....	1
1.2 Server Board Use Disclaimer	1
2. Product Overview.....	3
2.1 System Views	5
2.2 System Dimensions	6
2.3 System Components	7
2.4 Hard Drive and Peripheral Bays	8
2.5 Front Bezel Support.....	13
2.6 Rack and Cabinet Mounting Options	13
3. Power Sub-System.....	14
3.1 Mechanical Overview.....	14
3.2 Output Connectors.....	15
3.3 Efficiency	17
3.4 AC Input Voltage Specification	17
3.4.1 AC Line Transient Specification.....	17
3.4.2 Susceptibility Requirements	18
3.4.3 AC Line Fast Transient (EFT) Specification	19
3.4.4 AC Line Dropout/Holdup.....	19
3.4.5 Power Recovery	19
3.4.6 AC Line Inrush	20
3.4.7 AC Line Leakage Current	20
3.4.8 AC Line Fuse	20
3.4.9 Power Factor Correction.....	20
3.5 Protection Circuits.....	20
3.5.1 Over-Current Protection (OCP)	20
3.5.2 Over-voltage Protection (OVP)	21
3.5.3 Over-temperature Protection (OTP)	21
3.6 Power Supply Status LED	22
3.7 AC Inlet Connector	22
3.8 AC Power Cord Specification Requirements	22
4. Cooling Sub-System	23
4.1 Five-Fan Module.....	23
4.1.1 System Fan Board	25
4.2 Power Supply Fans.....	26
4.3 CPU Air Duct and Air Baffle.....	26
4.4 Drive Bay Population Requirement.....	27
4.5 DIMM Slot Blanks	28
5. Peripheral Drive Support.....	29

5.1	USB Floppy Drive Support.....	29
5.2	Optical Drive Support.....	30
6.	Hard Disk Drive Support.....	31
6.1	Hard Drive Trays.....	31
6.2	Fixed Mount Hard Drive Support	32
6.3	Hot-Swap Hard Drive Support	32
6.3.1	Backplane Feature set:.....	33
6.3.2	LED Support	39
6.3.3	Backplane Connector Definitions.....	39
7.	Standard Control Panel Functionality	46
7.1	Control Panel Buttons	47
7.2	Control Panel LED Indicators	48
7.2.1	Power/Sleep LED	49
7.2.2	System Status LED.....	49
7.2.3	Drive Activity LED	50
7.2.4	System Identification LED.....	50
7.3	Control Panel Connectors.....	51
8.	PCI Riser Card and Assembly	52
9.	Environmental and Regulatory Specifications	53
9.1	System Level Environmental Limits	53
9.2	Serviceability and Availability.....	53
9.3	Replacing the Back up Battery	54
9.4	Product Regulatory Compliance	55
9.5	Use of Specified Regulated Components.....	55
9.6	Electromagnetic Compatibility Notices	57
9.6.1	USA	57
9.6.2	FCC Verification Statement	58
9.6.3	ICES-003 (Canada)	58
9.6.4	Europe (CE Declaration of Conformity)	58
9.6.5	Japan EMC Compatibility	58
9.6.6	BSMI (Taiwan).....	59
9.6.7	RRL (Korea).....	59
9.7	Product Ecology Compliance.....	60
9.8	Other Markings	62
	Appendix A: Integration and Usage Tips.....	63
	Appendix B: POST Code Diagnostic LED Decoder	64
	Appendix C: POST Error Beep Codes	68
	Appendix D: Jumper Block Settings and Usage.....	69
	Glossary.....	73

List of Figures

Figure 1. Top Down View – Fixed Mount Hard Drive SKU	5
Figure 2. Top Down View – Hot-Swap Drive SKU	6
Figure 3. Major Chassis Components	7
Figure 4. Drive Bay Overview.....	8
Figure 5. Intel® Server Board S5400SF.....	9
Figure 6. Intel® Server Board “S5400SF” Components	11
Figure 7. Back Panel Feature Overview.....	11
Figure 8. Light Guided Diagnostics LED Locations	12
Figure 9. Front Bezel Options	13
Figure 10. Power Supply Mechanical Drawing.....	14
Figure 11. AC Power Cord Specifications	22
Figure 12. Fan Module Assembly.....	23
Figure 13. System Fan Board	25
Figure 14. Air Baffle.....	26
Figure 15. CPU Air Duct.....	27
Figure 16. Hot-Swap Hard Drive Tray with Drive Blank Installed	27
Figure 17. View of Slim-line Drive Bay	29
Figure 18. Intel® Server System SR1560SF Peripheral Bay Configuration Options.....	31
Figure 19. Fixed Drive Tray with Drive Blank Installed	31
Figure 20. Hot-Swap Hard Drive Tray Assembly.....	32
Figure 21. Hot-swap Passive SAS/SATA Backplane Layout.....	34
Figure 22. Active SAS Backplane Layout.....	35
Figure 23. Hot-Swap Passive SAS/SATA Backplane Functional Diagram.....	36
Figure 24. Hot-Swap Active SAS Backplane Functional Diagram.....	36
Figure 25. LSI* SAS1064E SAS Controller Functional Diagram	37
Figure 26. Bridge Board	40
Figure 27. Control Panel Module.....	46
Figure 28. Control Panel Overview Without Video	46
Figure 29. Standard Control Panel Overview	47
Figure 30. Control Panel Buttons	47
Figure 31. Control Panel LED Indicators	48
Figure 32. PCI Riser Card Assembly.....	52
Figure 33. 1U Full Height PCI Express* Riser Card Mechanical Drawing	52
Figure 34. Diagnostic LED Placement Diagram	64
Figure 35. Recovery Jumper Blocks.....	69
Figure 36. BIOS Select Jumper (J3H1).....	71

Figure 37. External RJ45 Serial Port Configuration Jumper 72

List of Tables

Table 1. System Feature Set.....	3
Table 2. Processor Support Matrix.....	4
Table 3. Chassis Dimensions.....	6
Table 4. Drive Overview.....	8
Table 5. Cable Harness Definition.....	15
Table 6. P1 – Main Power Connector Pin-out.....	15
Table 7. P2 – Processor Power Connector Pin-out.....	16
Table 8. P3 – Backplane Power Connector Pin-out.....	16
Table 9. P4 – Power Signal Connector Pin-out.....	16
Table 10. P5 & P6 - Peripheral Connector Pin-out.....	16
Table 11. Power Supply Efficiency.....	17
Table 12. AC Input Rating.....	17
Table 13. AC Line Sag Transient Performance.....	17
Table 14. AC Line Surge Transient Performance.....	18
Table 15. Performance Criteria.....	18
Table 16. AC Line Holdup time.....	19
Table 17. Over-current Protection (OCP).....	21
Table 18. Over-Voltage Protection (OVP) Limits.....	21
Table 19. LED Indicators.....	22
Table 20. Non-redundant Cooling Zones.....	24
Table 21. Individual Fan Assembly Pin-out.....	24
Table 22. System Fan Board-to-Baseboard Connector (J2A1) Pin-out.....	25
Table 23. System Fan Board Power Connector (J3B1) Pin-out.....	26
Table 24. 4-pin USB Floppy Connector Pin-out.....	29
Table 25. 44-pin Internal CD-ROM Connector Pin-out.....	30
Table 26. LED Function.....	39
Table 27. Hard Drive Activity LED Functionality.....	39
Table 28. Backplane Power Connector Pin-out (J1B1).....	39
Table 29. Bridge Board Connector Pin-out (J5A1).....	40
Table 30. Backplane Control Panel Connector Pin-out (J9C1).....	42
Table 31. 1x10 Pin Control Panel USB Connector Pin-out (J6B1).....	42
Table 32. SAS/SATA Hard Drive Connector Pin-out (J8N1, J6N1, J3N1).....	43
Table 33. SATA/SAS Drive Control Connector Pin-out (J3C1, J4B2, J4A1).....	43
Table 34. 4-pin Floppy Connector Pin-out (J2B1).....	44
Table 35. System Fan Connector Pin-outs.....	44
Table 36. IPMB Connector Pin-out (J1C1).....	45

Table 37. Add-in Card Connector Pin-out (J4B3 – Passive Only)	45
Table 38. Control Button and Intrusion Switch Functions	48
Table 39. Control Panel LED Functions	48
Table 40. SSI Power LED Operation	49
Table 41. Control Panel LED Operation	49
Table 42. External USB Connectors (J1B1)	51
Table 43. Video Connector (J1A1)	51
Table 44. System Environmental Limits Summary	53
Table 45. Product Safety & Electromagnetic (EMC) Compliance	56
Table 46: POST Progress Code LED Example	64
Table 47. Diagnostic LED POST Code Decoder	65
Table 48. POST Error Beep Codes	68
Table 49. BMC Beep Codes	68
Table 50. Recovery Jumpers	69

< This page intentionally left blank >

1. Introduction

This Technical Product Specification (TPS) provides system specific information detailing the features, functionality, and high level architecture of the Intel® Server System SR1560SF. The Intel® Server Board S5400SF Technical Product Specification should also be referenced to obtain greater detail of functionality and architecture specific to the integrated server board, but which are also supported on this server system.

In addition, design level information for specific sub-systems can be obtained by ordering the External Product Specifications (EPS) or External Design Specifications (EDS) for a given sub-system. EPS and EDS documents are not publicly available. They are only made available under NDA with Intel and must be ordered through your local Intel representative. See the *Reference Documents* section at the end of this document for a complete list of available documents.

The Intel® Server System SR1560SF may contain design defects or errors known as errata which may cause the product to deviate from published specifications. Refer to the *Intel® Server Board S5400SF/Intel® Server System SR1560SF Specification Update* for published errata.

1.1 Chapter Outline

This document is divided into the following chapters

- Chapter 1 – Introduction
- Chapter 2 – Product Overview
- Chapter 3 – Power Sub-System
- Chapter 4 – Cooling Sub-System
- Chapter 5 – Peripheral Drive Support
- Chapter 6 – Hard Drive Support
- Chapter 7 – Standard Control Panel Functionality
- Chapter 8 – PCI Riser Card and Assembly
- Chapter 9 – Environmental and Regulatory Specifications
- Appendix A – Integration and Usage Tips
- Appendix B – POST Code Diagnostic LED Decoder
- Appendix C – Post Error Beep Codes
- Appendix D – Jumper Block Settings and Usage
- Glossary
- Reference Documents

1.2 Server Board Use Disclaimer

Intel Corporation server boards support add-in peripherals and contain a number of high-density VLSI and power delivery components that need adequate airflow to cool. Intel ensures through its own chassis development and testing that when Intel server building blocks are used together, the fully integrated system will meet the intended thermal requirements of these components. It is the responsibility of the system integrator who chooses not to use Intel developed server building blocks to consult vendor datasheets and operating parameters to determine the amount of air flow required for their specific application and environmental

conditions. Intel Corporation cannot be held responsible if components fail or the server board does not operate correctly when used outside any of their published operating or non-operating limits.

2. Product Overview

The Intel® Server System SR1560SF is a rack mount 1U server system with features that are designed to support the high-density high performance computing server market. The system is integrated with an Intel® Server Board S5400SF and is offered in two different system configurations: one which supports up to two fixed SATA hard drives, and one which supports hot-swap backplane options capable of supporting up to three hot-swap SAS or SATA hard drives.

This chapter provides a high-level overview of the system features. Greater detail for each major system component or feature is provided in the following chapters.

Table 1. System Feature Set

Feature	Description
Processors	771-pin LGA sockets supporting 1 or 2 Multi-Core Intel® Xeon® processors 5000 sequence, with system bus speeds of 1066 MHz, 1333 MHz, and 1600 MHz ¹
Memory	16 Keyed DIMM slots supporting fully buffered DIMM technology (FBDIMM) memory. Only 240-pin DDR2-667 or DDR2-800 FBDIMMs will be supported in this server system
Chipset	Intel® Chipset which includes the following components: <ul style="list-style-type: none"> ▪ Intel® 5400 Memory Controller Hub ▪ Intel® 6321ESB I/O Controller Hub
System Connectors/Headers	External I/O connections: <ul style="list-style-type: none"> ▪ Stacked PS/2* ports for keyboard and mouse ▪ RJ45 Serial B port ▪ Two RJ45 NIC connectors for 10/100/1000 Mb connections ▪ Two USB 2.0 ports ▪ Video Connector Internal connectors/headers: <ul style="list-style-type: none"> ▪ One USB port header, capable of providing two USB 2.0 ports ▪ One DH10 Serial A header ▪ SATA ports via the ESB2-E supporting 3Gb/s and integrated SW RAID 0/1/10 support ▪ One 44pin (power + I/O) ATA/100 connector for optical drive support ▪ One Intel® Remote Management Module-2 (Intel® RMM2) connector (Intel® RMM2 use is optional) ▪ One Intel® I/O Expansion Module Connector supporting any of the following: <ul style="list-style-type: none"> ○ Dual GB NIC Intel® I/O Expansion Module (Optional) ○ External SAS Intel® I/O Expansion Module (Optional) ○ Infiniband* I/O Expansion Module (Optional)
System Fan Support	<ul style="list-style-type: none"> ▪ Non-redundant fan assembly with five managed dual rotor variable speed fans ▪ Two Non-redundant power supply fans
Add-in Adapter Support	One full height riser card slot supporting PCIe* x16 Gen 2 riser card
On-board Video	ATI* ES1000 video controller with 32MB DDR SDRAM
LAN Support	Two 10/100/1000 Intel® 82563EB PHYs supporting Intel® I/O Acceleration Technology

¹ See supported processor table

Feature	Description
Hard Drive Controller Options	<ul style="list-style-type: none"> ▪ Integrated ESB2-E 3Gb/s SATA ports, for use in Fixed Drive and Passive Backplane configurations ▪ LSI* LSISAS1064E SAS/SATA controller RAID Controller, integrated on Active SAS backplane option for use in hot swap backplane configuration ▪ Support for Intel® Embedded Server RAID Technology II with SW RAID levels 0/1/10. ▪ Optional support for SW RAID 5 with activation key.
Hard Drive Support	<ul style="list-style-type: none"> ▪ Up to two fixed SATA drives in Fixed Drive SKU ▪ Up to three SATA/SAS Drives in Hot Swap Drive SKU
Peripheral Drive Support	<ul style="list-style-type: none"> ▪ One Slim-line IDE optical drive ▪ Slim-line USB Floppy Drive option (Hot Swap Backplane configurations Only)
System Power	600 Watt Non-redundant
Front Panel Options	<p>Intel Standard Control Panel has the following options:</p> <ul style="list-style-type: none"> ▪ System Control Buttons – Power, Reset, System ID, NMI ▪ System LEDs – System Power, NIC Activity, HDD Activity, System Status, System ID ▪ USB Port ▪ Video Connector (Hot-Swap Backplane Configurations only)
System Management	Support for Intel® System Management Software

Table 2. Processor Support Matrix

Processor Family	System Bus Speed	Core Frequency	Cache	Watts	Support
Dual-Core Intel® Xeon® processor 50xx	All	All	All	All	No
Dual-Core Intel® Xeon® processor 51xx	All	All	All	> 40 Watt	No
Quad-Core Intel® Xeon® processor E53xx	All	All	All	All	No
Quad-Core Intel® Xeon® processor X53xx	All	All	All	All	No
Dual-Core Intel® Xeon® processor LV5148	1333 MHz	2.33 GHz	4 MB shared	40	Yes
Dual-Core Intel® Xeon® processor LV5138	1066 MHz	2.13 GHz	4 MB shared	35	Yes
Quad-Core Intel® Xeon® processor L5310	1066 MHz	1.60 GHz	8 MB shared	50	Yes
Quad-Core Intel® Xeon® processor L5320	1066 MHz	1.86 GHz	8 MB shared	50	Yes
Quad-Core Intel® Xeon® processor L5335	1333 MHz	2.00 GHz	8 MB shared	50	Yes
Dual-Core Intel® Xeon® processor 52xx	All	All	6 MB shared	120 Watt or less	Yes
Quad-Core Intel® Xeon® processor 54xx	All	All	12MB shared	120 Watt or less	Yes

2.1 System Views

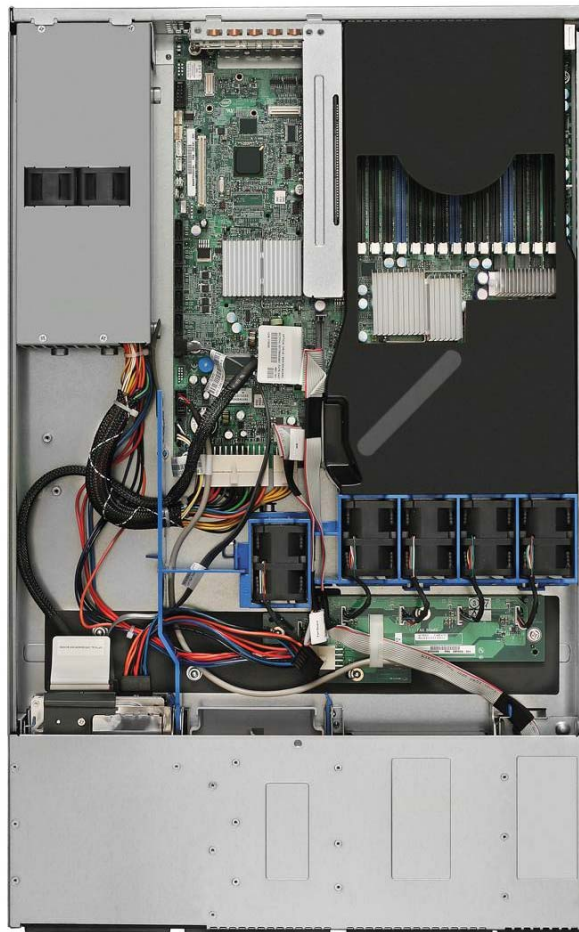

Figure 1. Top Down View – Fixed Mount Hard Drive SKU

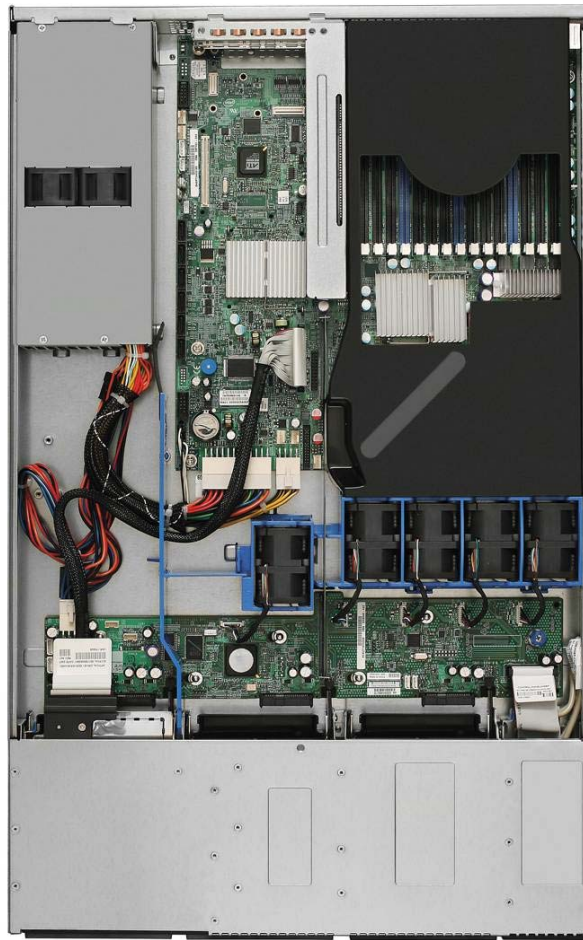

Figure 2. Top Down View – Hot-Swap Drive SKU

2.2 System Dimensions

Table 3. Chassis Dimensions

Height	43.25 mm	1.703"
Width without rails	430 mm	16.930"
Width with rails	451.3 mm	17.77"
Depth without CMA	692 mm	27.25"
Depth with CMA	838.2 mm	33.0"
Max. Weight (Fixed drive version)	13.38 kg	29.5 lbs
Max. Weight (Hot-Swap drive version)	14.29 kg	31.5 lbs

2.3 System Components

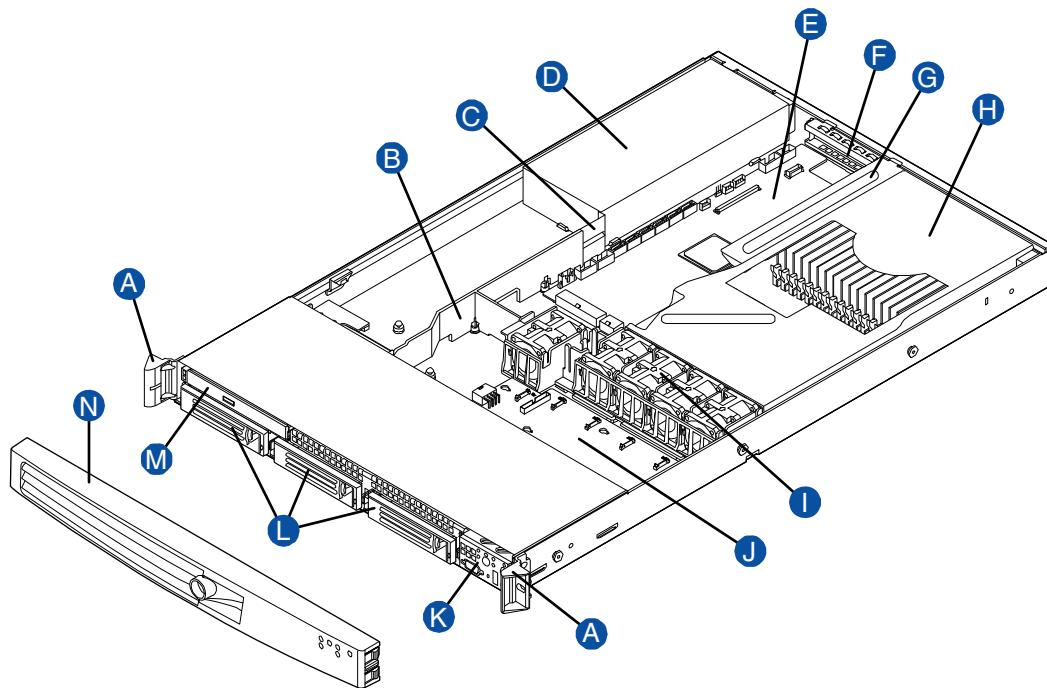

AF002186

A	Rack handles (optional)	H	Processor air duct
B	Small air baffle	I	System Fan Assembly
C	Air baffle	J	System Fan board used in fixed drive system; or backplane used in hot-swap system
D	Power supply	K	Control panel
E	Server board	L	Hard drive bays: Two hard drives supported for fixed drive system (left and center drives) Three hard drives supported for hot-swap system
F	PCI card bracket (full height)	M	Slimline drive bay
G	PCI add-in riser assembly	N	Front bezel (optional)

Not shown: Bridge board (only in hot-swap system)

Figure 3. Major Chassis Components

2.4 Hard Drive and Peripheral Bays

Table 4. Drive Overview

	Fixed Drive System Product Code - SR1560SF	Hot Swap Drive System Product Code - SR1560SFHS
Slim-line IDE Optical Drive	Supported	Supported
Slim-line USB Floppy Drive	No Support	Supported ¹
SATA Drives	Up to 2	Up to 3
SAS Drives	No Support	Up to 3 w/Active Backplane Option

¹ - If both an optical drive and floppy drive are required, the hard drive bay below the slim-line bay can be used to support an optional USB Floppy drive in the hot swap drive system SKU. The optional USB floppy drive kit includes the necessary drive tray and cables

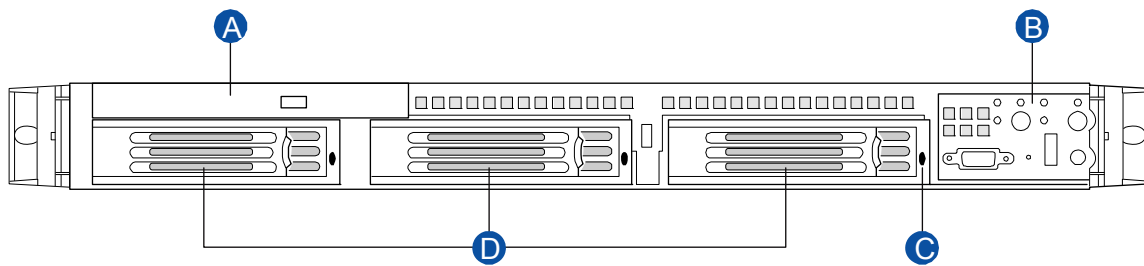

AF002191

A	Slim-line drive bay
B	Intel Standard Control Panel
C	Hard Drive Status LEDs (Hot-swap drives only)
D	Hard drive bays

Figure 4. Drive Bay Overview

Server Board Overview

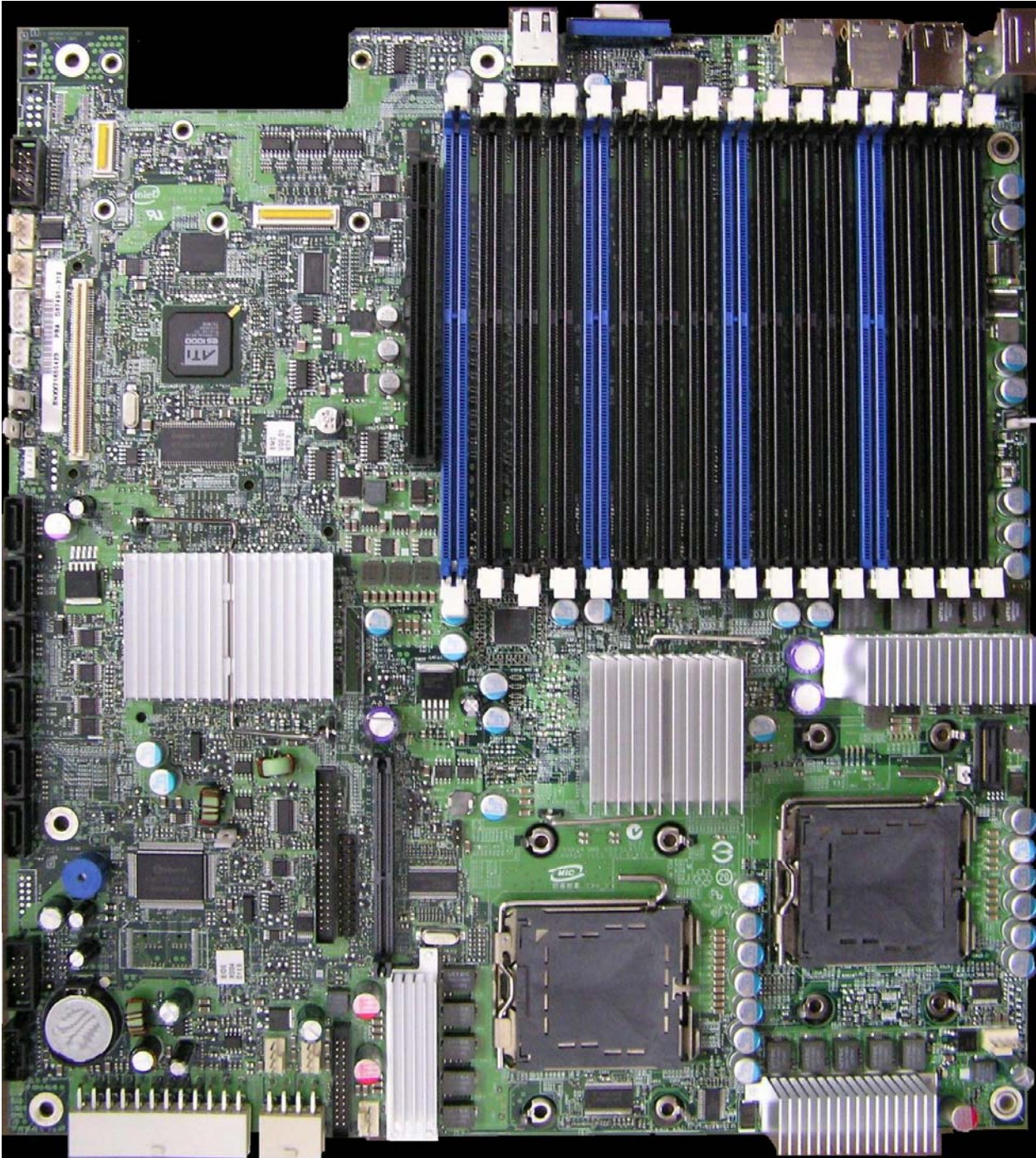
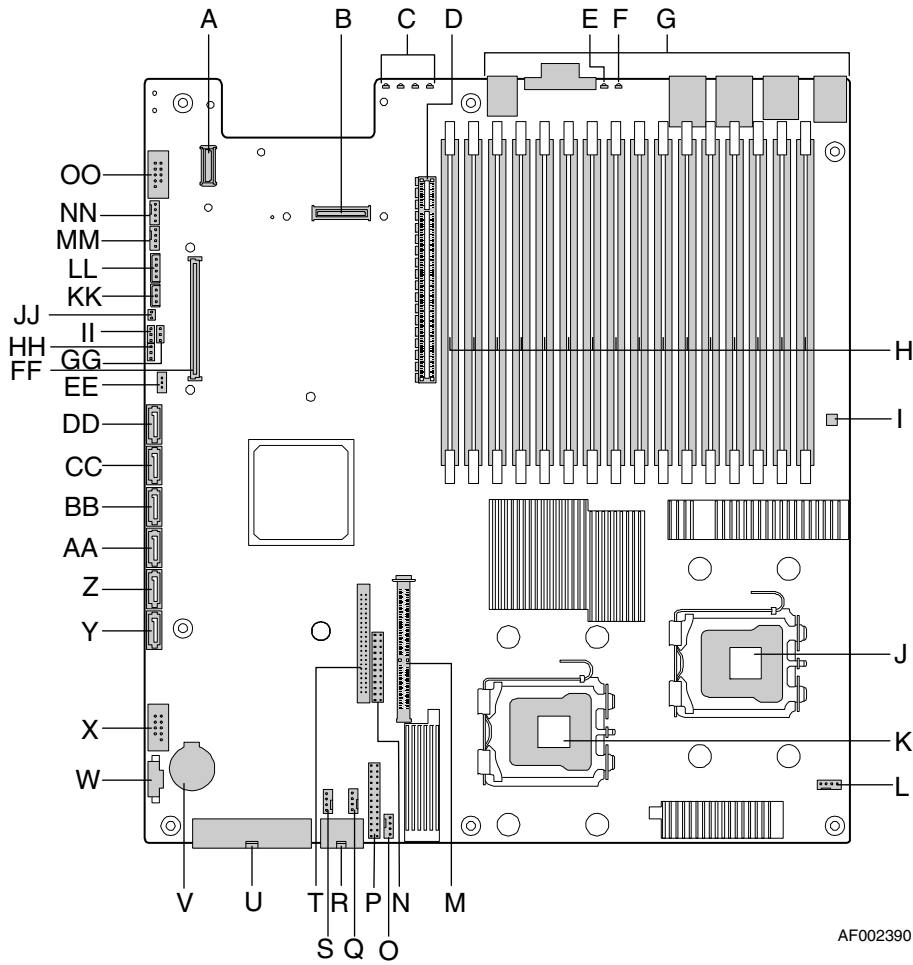

Figure 5. Intel® Server Board S5400SF

The following figure shows the board layout of the server board. Each connector and major component is identified by a number or letter, and a description is given below the figure:



AF002390

A	Intel® RMM2 NIC Connector	U	Main Power Connector
B	IO Module Option Connector	V	Battery
C	POST Code Diagnostic LEDs	W	Power Supply Management Connector
D	PCI Express* Riser Connector (x16 Gen2)	X	Dual Port USB 2.0 Header (USB0-1)
E	System Identification LED - Blue	Y	SATA0
F	System Status LED – Green/Amber	Z	SATA1
G	External IO Connectors	AA	SATA2
H	FBDIMM Memory Sockets	BB	SATA3
I	Serial 'B' Port Configuration Jumper	CC	SATA4
J	Processor 1 Socket	DD	SATA5
K	Processor 2 Socket	EE	SATA SW RAID 5 Activation Key Connector
L	Processor 1 Fan	FF	Intel® Remote Management Module 2 Connector
M	Bridge Board Connector	GG	BMC FRU Update Jumper
N	SSI 24-pin Control Panel Header	HH	CMOS Clear Jumper
O	Processor 2 Fan	II	Password Clear Jumper
P	Fan Board Connector	JJ	Chassis Intrusion Switch Header
Q	System Fan 2	KK	3-pin IPMB Header
R	CPU Power Connector	LL	4-pin IPMB Header

S	System Fan 1	MM	System Fan 3
T	ATA-100 Optical Drive Connector (Power+IO)	NN	System Fan 4
		OO	Serial 'A' Header

Figure 6. Intel® Server Board “S5400SF” Components

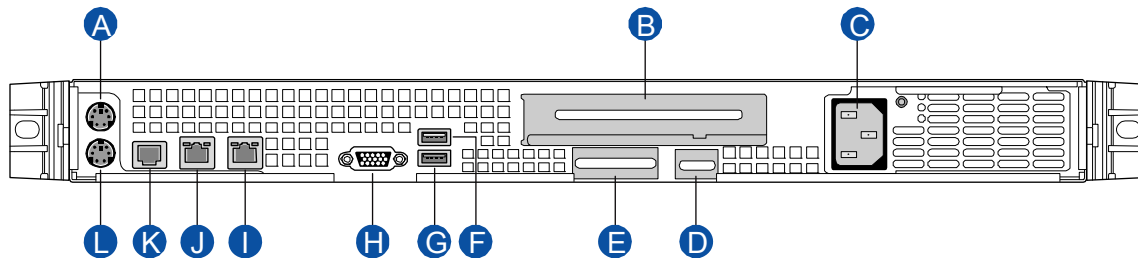

AF002187

A	PS2 mouse connector	G	USB 2 connector
B	Add-in card bracket (full height)	H	Video connector
C	AC Power Receptacle	I	NIC 1 connector
D	Management Network Interface (optional)	J	NIC 2 connector
E	IO module external connector (optional)	K	RJ45 serial B port
F	USB 1 connector	L	PS2 keyboard connector

Figure 7. Back Panel Feature Overview

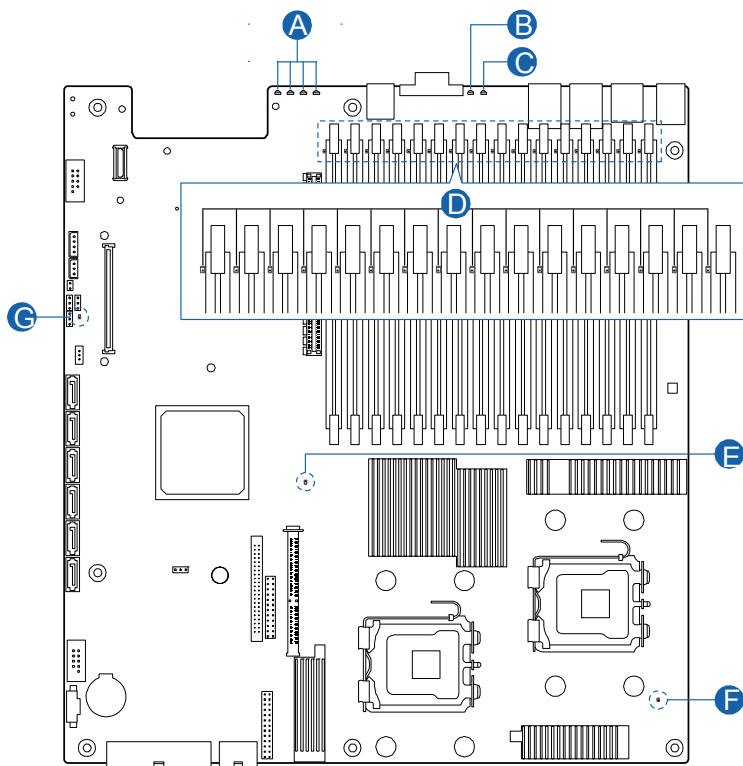

AF002160

	Description		Description
A	Diagnostic LEDs	E	Processor 2 Fault LED
B	System ID LED	F	Processor 1 Fault LED
C	Status LED	G	5V Standby LED
D	DIMM Fault LEDs		

Figure 8. Light Guided Diagnostics LED Locations

2.5 Front Bezel Support

The optional front bezel is made of molded plastic and uses a snap-on design. When installed, its design allows for maximum airflow to maintain system cooling requirements. (Intel Product Code – ADWBEZBLACK).

Light pipes in the front bezel supporting the standard control panel allow the system status LEDs to be monitored with the bezel installed.

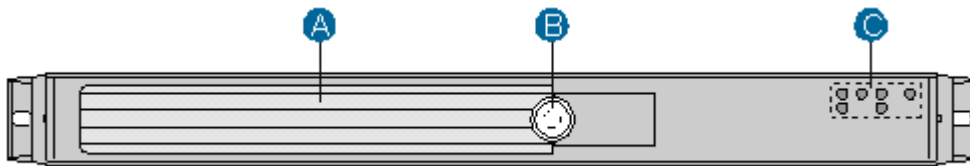

A	Ventilation
B	Key Lock
C	System Status LEDs

Figure 9. Front Bezel Options

2.6 Rack and Cabinet Mounting Options

The chassis was designed to support 19" wide by up to 30" deep server cabinets. The system supports the following three Intel rack mount options:

- A fixed mount relay rack/cabinet mount kit (Product order code - AXXBRACKETS) which can be configured to mount the system into either a 2-post rack or 4-post cabinet
- A tool-less full extracting slide rail kit (Product order code – AXXHERAIL) designed to support an optional cable management arm (Product order code – AXXRACKCARM).
- A basic slide rail kit (Product order code – AXXBASRAIL13) is designed to mount the chassis into a standard (19" by up to 30" deep) EIA-310D compatible server cabinet.

3. Power Sub-System

The power sub-system consists of a single non-redundant 600 W High Efficiency power supply with eight outputs; 3.3V, 5V, 12V1, 12V2, 12V3, 12V4, -12V and 5VSB. The input are auto ranging and power factor corrected. The form factor is SSI EPS1U at 240mm depth and wire harness output. The power supply provides two non-redundant 40mm fans for self cooling, and which also contribute to providing additional airflow for parts of the system.

This chapter provides basic technical details to the design and operation of the power supply.

3.1 Mechanical Overview

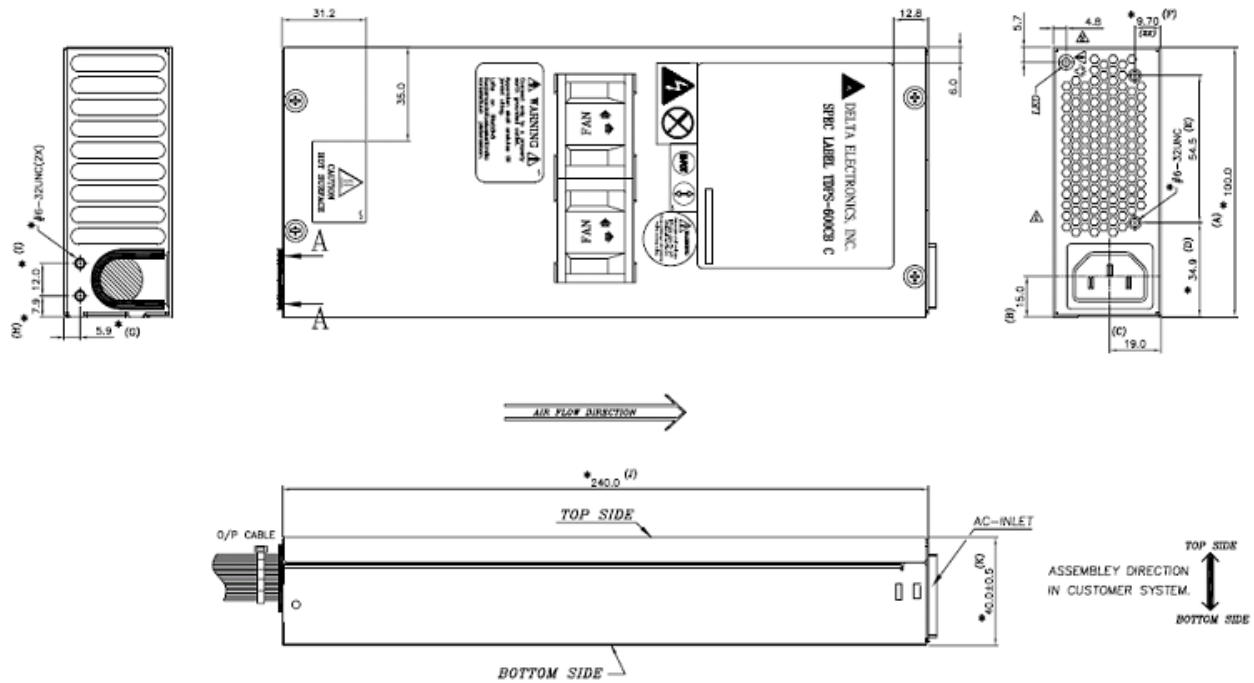

Note:

1. All dimensions are in mm.
2. The tolerance of the 40mm height dimension (marked with letter C) pertains to the metal case only

Figure 10. Power Supply Mechanical Drawing

3.2 Output Connectors

The power supply has a cable harness with four power connectors used to power various platform sub-systems. The following table defines each power connector

Table 5. Cable Harness Definition

From	Length	To	Description
Case	230	P1	Main Power Connector
Case	270	P2	Processor Power Connector
Case	387	P3	Backplane power Connector
Case	260	P4	Power Signal Connector
P3	165	P5	SATA Power Connector
P5	165	P6	SATA Power Connector

P1 – Main Power Connector

Connector housing: 24-Pin Molex* Mini-Fit Jr. 39-01-2245 or equivalent

Contact: Molex Mini-Fit, HCS, Female, Crimp 44476 or equivalent

Table 6. P1 – Main Power Connector Pin-out

Pin	Signal	18 AWG Color	Pin	Signal	18 AWG Color
1	+3.3 VDC	Orange	13	+3.3 VDC	Orange
2	+3.3 VDC	Orange	14	-12 VDC	Blue
3	COM	Black	15	COM	Black
4	+5 VDC*	Red	16	PSON#	Green
5	COM	Black	17	COM	Black
6	+5 VDC	Red	18	COM	Black
7	COM	Black	19	COM	Black
8	PWR OK	Gray	20	Reserved	N.C.
9	5VSB	Purple	21	+5 VDC	Red
10	+12V3	Yellow/Blue Stripe	22	+5 VDC	Red
11	+12V3	Yellow/Blue Stripe	23	+5 VDC	Red
12	+3.3 VDC	Orange	24	COM	Black

Notes:

1. 5V Remote Sense Double Crimped into pin 4.
2. 3.3V Locate Sense Double Crimped into pin 2.

P2 – Processor Power Connector

Connector housing: 8-Pin Molex 39-01-2085 or equivalent

Contact: Molex, Mini-Fit Jr, HCS, 44476-1111 or equivalent

Table 7. P2 – Processor Power Connector Pin-out

PIN	SIGNAL	18 AWG COLOR	PIN	SIGNAL	18 AWG COLOR
1	COM	Black	5	+12V1	Yellow
2	COM	Black	6	+12V1	Yellow
3	COM	Black	7	+12V2	Yellow/Black Stripe
4	COM	Black	8	+12V2	Yellow/Black Stripe

P3 – Backplane/System Fan Board Power Connector

Connector housing: 8-Pin Molex 39-01-2085 2x4 or equivalent

Contact: Molex 2x4 mini fit Jr, HCS, 44476-1111 or equivalent

Table 8. P3 – Backplane Power Connector Pin-out

PIN	SIGNAL	18AWG Color	PIN	SIGNAL	18AWG Color
1	GND	Black	5	+12V4	Blue/White Stripe
2	GND	Black	6	+12V4	Blue/White Stripe
3	+5V	Red	7	5VSB	Purple
4	+5V	Red	8	+3.3V	Orange

P4 – Power Signal Connector

Connector housing: 5-pin Molex 50-57-9705 or equivalent

Contacts: Molex 16-02-0087 or equivalent

Table 9. P4 – Power Signal Connector Pin-out

Pin	Signal	24 AWG Color
1	I2C Clock	White/Green Stripe
2	I2C Data	White/Yellow Stripe
3	NC	NC
4	COM	Black
5	3.3RS	White/Brown Stripe

P5, P6 Peripheral Connector:

Connector housing: JWT A3811H00-5P (94V2) or equivalent;

Contact: JWT A3811TOP-0D or equivalent

Table 10. P5 & P6 - Peripheral Connector Pin-out

PIN	SIGNAL	18 AWG COLOR
1	+12Vdc	Yellow
2	COM	Black
3	COM	Black
4	+5 Vdc	Red

3.3 Efficiency

The following table provides the required minimum efficiency level at various loading conditions. These are provided at three different load levels; 100%, 50% and 20%. Efficiency was tested over an AC input voltage range of 115VAC to 220VAC.

Table 11. Power Supply Efficiency

Loading	100% of maximum	50% of maximum	20% of maximum
Minimum Efficiency	80%	80%	80%

3.4 AC Input Voltage Specification

The power supply operates within all specified limits over input voltage range shown in the following table. Harmonic distortion of up to 10% THD will not cause the power supply to go out of specified limits. The power supply shall power off if the AC input is less than 75VAC +/-5VAC range. The power supply shall start up if the AC input is greater than 85VAC +/-4VAC. Application of an input voltage below 85VAC will not cause damage to the power supply, including a fuse blow.

Table 12. AC Input Rating

Parameter	Min	Rated	Max	Start up VAC	Power Off VAC
Voltage (110)	90 V _{rms}	100-127 V _{rms}	140 V _{rms}	85Vac +/-4Vac	75Vac +/-5Vac
Voltage (220)	180 V _{rms}	200-240 V _{rms}	264 V _{rms}		
Frequency	47 Hz		63 Hz		

3.4.1 AC Line Transient Specification

AC line transient conditions are defined as “sag” and “surge” conditions. “Sag” conditions are also commonly referred to as a “brown-out”. These conditions are defined as the AC line voltage dropping below nominal voltage conditions. “Surge” refers to conditions when the AC line voltage rises above nominal voltage.

The power supply meets the requirements under the following AC line sag and surge conditions.

Table 13. AC Line Sag Transient Performance

AC Line Sag				
Duration	Sag	Operating AC Voltage	Line Frequency	Performance Criteria
Continuous	10%	Nominal AC Voltage ranges	50/60Hz	No loss of function or performance
0 to 1 AC cycle	100%	Nominal AC Voltage ranges	50/60Hz	No loss of function or performance
> 1 AC cycle	>10%	Nominal AC Voltage ranges	50/60Hz	Loss of function acceptable, self recoverable

100% sag will be performed at 80% load for 1AC cycle.

Table 14. AC Line Surge Transient Performance

AC Line Surge				
Duration	Surge	Operating AC Voltage	Line Frequency	Performance Criteria
Continuous	10%	Nominal AC Voltages	50/60Hz	No loss of function or performance
0 to ½ AC cycle	30%	Mid-point of nominal AC Voltages	50/60Hz	No loss of function or performance

3.4.2 Susceptibility Requirements

The power supply meets the following electrical immunity requirements:

Table 15. Performance Criteria

Level	Description
A	The apparatus shall continue to operate as intended. No degradation of performance.
B	The apparatus shall continue to operate as intended. No degradation of performance beyond spec limits.
C	Temporary loss of function is allowed provided the function is self-recoverable or can be restored by the operation of the controls.

3.4.2.1 Electrostatic Discharge Susceptibility

The power supply complies with the limits defined in EN 55024: 1998 using the IEC 61000-4-2:1995 test standard and performance criteria B defined in Annex B of CISPR 24. Tested to meet the level 3 requirement.

3.4.2.2 Fast Transient/Burst

The power supply complies with the limits defined in EN55024: 1998 using the IEC 61000-4-4:1995 test standard and performance criteria B defined in Annex B of CISPR 24. Test to meet the level 3 requirement.

3.4.2.3 Radiated Immunity

The power supply complies with the limits defined in EN55024: 1998 using the IEC 61000-4-3:1995 test standard and performance criteria A defined in Annex B of CISPR 24.

3.4.2.4 Surge Immunity

The power supply was tested with the system for immunity to AC Ringwave and AC Unidirectional wave, both up to 2kV, per EN 55024:1998, EN 61000-4-5:1995 and ANSI C62.45: 1992.

The pass criteria include: No unsafe operation is allowed under any condition; all power supply output voltage levels to stay within proper spec levels; No change in operating state or loss of data during and after the test profile; No component damage under any condition.

The power supply complies with the limits defined in EN55024: 1998 using the IEC 61000-4-5:1995 test standard and performance criteria B defined in Annex B of CISPR 24.

3.4.3 AC Line Fast Transient (EFT) Specification

The power supply meets the *EN61000-4-5* directive and any additional requirements in *IEC1000-4-5:1995* and the Level 3 requirements for surge-withstand capability, with the following conditions and exceptions:

- These input transients must not cause any out-of-regulation conditions, such as overshoot and undershoot, nor must it cause any nuisance trips of any of the power supply protection circuits.
- The surge-withstand test must not produce damage to the power supply.

The supply meets surge-withstand test conditions under maximum and minimum DC-output load conditions.

3.4.4 AC Line Dropout/Holdup

Table 16. AC Line Holdup time

Loading	Holdup time
80%	20msec
100%	12msec

An AC line **dropout** is defined to be when the AC input drops to 0VAC at any phase of the AC line for any length of time. During an AC dropout the power supply must meet dynamic voltage regulation requirements. An AC line dropout of any duration shall not cause tripping of control signals or protection circuits. If the AC dropout lasts longer than the hold up time the power supply should recover and meet all turn on requirements. The power supply shall meet the AC dropout requirement over rated AC voltages and frequencies. A dropout of the AC line for any duration shall not cause damage to the power supply.

3.4.4.1 AC Line 5VSB Holdup

The 5VSB output voltage will stay in regulation under its full load (static or dynamic) during an AC dropout of **70ms** min (=5VSB holdup time) whether the power supply is in ON or OFF state (PSON asserted or de-asserted).

3.4.5 Power Recovery

The power supply will recover automatically after an AC power failure. AC power failure is defined to be any loss of AC power that exceeds the dropout criteria.

3.4.5.1 Voltage Brown Out

The power supply complies with the limits defined in EN55024: 1998 using the IEC 61000-4-11:1995 test standard and performance criteria C defined in Annex B of CISPR 24.

In addition the power supply meets the following Intel Requirements:

A continuous input voltage below the nominal input range shall not damage the power supply or cause overstress to any power supply component. The power supply must be able to return to normal power up state after a brownout condition. Maximum input current under a continuous

brownout shall not blow the fuse. The power supply will tolerate a 3min ramp from 90VAC voltage to 0VAC after the components have reached a steady state condition.

3.4.5.2 Voltage Interruptions

The power supply complies with the limits defined in EN55024: 1998 using the IEC 61000-4-11:1995 test standard and performance criteria C defined in Annex B of CISPR 24.

3.4.6 AC Line Inrush

AC line inrush current will not exceed **40A peak** for up to one-quarter of the AC cycle, after which, the input current should be no more than the specified maximum input current. The peak inrush current shall be less than the ratings of its critical components (including input fuse, bulk rectifiers, and surge limiting device).

The power supply meets the inrush requirements for any rated AC voltage, during turn on at any phase of AC voltage, during a single cycle AC dropout condition as well as upon recovery after AC dropout of any duration, and over the specified temperature range (T_{op}). It is acceptable that AC line inrush current may reach up to **60A peak** for up to 1 ms.

3.4.7 AC Line Leakage Current

The maximum leakage current to ground for each power supply is 3.5mA when tested at 240VAC.

3.4.8 AC Line Fuse

The power supply has a **single line fuse**, on the Line (Hot) wire of the AC input. The line fusing is acceptable for all safety agency requirements. The input fuse is a slow blow type. AC inrush current will not cause the AC line fuse to blow under any conditions. All protection circuits in the power supply will not cause the AC fuse to blow unless a component in the power supply has failed. This includes DC output load short conditions.

3.4.9 Power Factor Correction

The power supply incorporates a Power Factor Correction circuit.

The power supply was tested as described in EN 61000-3-2: Electromagnetic Compatibility (EMC) Part 3: Limits- Section 2: Limits for harmonic current emissions, and meets the harmonic current emissions limits specified for ITE equipment.

The power supply was tested as described in JEIDA MITI Guideline for Suppression of High Harmonics in Appliances and General-Use Equipment and meets the harmonic current emissions limits specified for ITE equipment

3.5 Protection Circuits

Protection circuits inside the power supply will cause only the power supply's main outputs to shutdown. If the power supply latches off due to a protection circuit tripping, an AC cycle OFF for 15 sec and a PSON[#] cycle HIGH for 1 sec shall be able to reset the power supply.

3.5.1 Over-Current Protection (OCP)

The power supply will have current limits to prevent the +3.3V, +5V, and +12V outputs from exceeding the values shown in the following table. If the current limits are exceeded, the power

supply will shutdown and latch off. The latch will be cleared by toggling the PSON[#] signal or by an AC power interruption. The power supply will not be damaged from repeated power cycling in this condition. -12V and 5VSB will be protected under over-current or shorted conditions so that no damage can occur to the power supply. Auto-recovery feature is a requirement on 5VSB rail.

Table 17. Over-current Protection (OCP)

VOLTAGE	OVER CURRENT LIMIT (IOUT LIMIT)
+3.3V	110% minimum (= 22A) ; 150% maximum (= 30A)
+5V	110% min (= 26.4A); 150% max (= 36A)
+12V1	18A min; 20A max
+12V2	18A min; 20A max
+12V3	18A min; 20A max
+12V4	18A min; 20A max
-12V	0.625A min; 2.0A max
5VSB	6.0A max

3.5.2 Over-voltage Protection (OVP)

The power supply over-voltage protection is locally sensed. The power supply will shutdown and latch off after an over-voltage condition occurs. This latch is cleared by toggling the PSON[#] signal or by an AC power interruption. The following table contains the over-voltage limits. The values are measured at the output of the power supply's connectors. The voltage will never exceed the maximum levels when measured at the power pins of the power supply connector during any single point of fail. The voltage will never trip any lower than the minimum levels when measured at the power pins of the power supply connector.

Exception: +5VSB rail should be able to recover after an over-voltage condition occurs.

Table 18. Over-Voltage Protection (OVP) Limits

Output Voltage	MIN (V)	MAX (V)
+3.3V	+3.9	+4.5
+5V	+5.7	+6.2
+12V1,2, 3, 4	+13.3	+14.5
-12V	-13.3	-14.5
+5VSB	+5.7	+6.5

3.5.3 Over-temperature Protection (OTP)

The power supply is protected against over-temperature conditions caused by loss of fan cooling or excessive ambient temperature. In an OTP condition, the PSU will shutdown. When the power supply temperature drops to within specified limits, the power supply shall restore power automatically, while the 5VSB remains always on. The OTP circuit has built in hysteresis such that the power supply will not oscillate on and off due to a temperature recovering condition. The OTP trip level has a minimum of 4 C of ambient temperature hysteresis.

3.6 Power Supply Status LED

There is a single bi-color LED to indicate the power supply status. The LED operation is defined in the following table.

Table 19. LED Indicators

Power Supply Condition	LED
No AC power to all power supplies	OFF
Power supply critical event causing a shutdown; failure, OCP, OVP, Fan Fail	AMBER
AC present/Only 5VSB on (PS off)	1Hz Blink GREEN
Output ON and OK	GREEN

3.7 AC Inlet Connector

The AC input connector is an *IEC 320 C-14* power inlet. This inlet is rated for 15A/250VAC.

3.8 AC Power Cord Specification Requirements

The AC power cord used must meet the following specification requirements:

Cable Type	SJT
Wire Size	16 AWG
Temperature Rating	105° C
Amperage Rating	13A
Voltage Rating	125V

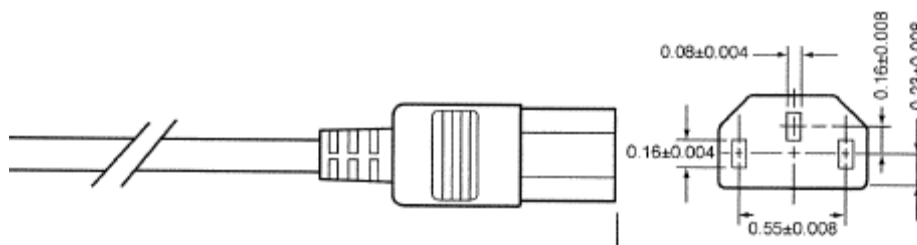

Figure 11. AC Power Cord Specifications

4. Cooling Sub-System

The system components that make up the cooling sub-system include: five managed 40x40x56mm dual rotor fans, two 40x40x28mm power supply fans, a CPU air duct, and an air baffle. Together, these components provide the necessary airflow needed to meet the thermal requirements of the system when operating within specified thermal limits. See Table 44. System Environmental Limits Summary.

In order to maintain the necessary airflow within the system, the air baffle, CPU air duct, and the top cover need to be properly installed.

Note: The Intel® Server System SR1560SF does not support redundant cooling. Should any of the fans fail, the system should be powered down as soon as possible to have the fan replaced.

4.1 Five-Fan Module

The system includes a fan assembly consisting of five managed 40x40x56mm dual rotor multi-speed fans. Four fans provide the primary cooling for the processors, memory, and the second and third hard drive bays. The fifth fan provides the primary cooling for the components in the full height PCI zone.

Fan replacement and removal of the entire fan assembly from the system does not require the use of any tools. Each fan within the assembly can be replaced. Neither the fan assembly nor the individual fans within it are hot-swappable. The server must be turned off before any of the fans can be replaced.

Each fan within the fan assembly has a 10-pin wire harness which, depending on the system configuration used, connects to either a hot-swap backplane or a system fan board. Each individual wire harness provides the fan with power and includes tachometer lines allowing the fans to be monitored independently by Intel® System Management Software.

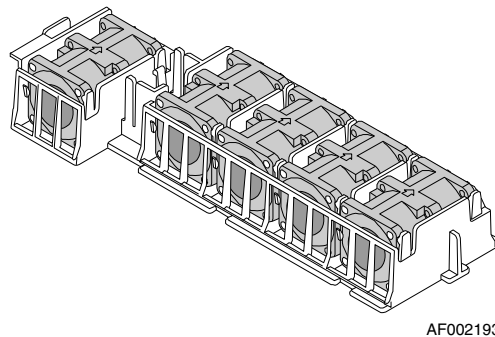

Figure 12. Fan Module Assembly

Table 20. Non-redundant Cooling Zones

Fan	Cooling Zone	Description of greatest cooling influence
System Fan #1/2	CPU1	Primary cooling for CPU1 and memory
System Fan #3/4	CPU2	Primary cooling for hard drive2, CPU2, the MCH, and memory
System Fan #5	PCI	Primary cooling for hard drive1, PCI Express* add-in cards, and server board components that components in the full height PCI zone
Power Supply Fans 2 fans per module	Power Supply	Primary cooling for hard drive 0, and the power supply

The system fan assembly has been designed for ease of use and has support for several management features that can be utilized by the server board management system.

- Each fan within the assembly is capable of supporting multiple speeds. If the internal ambient temperature of the system exceeds the value programmed into the thermal sensor data record (SDR), the BMC firmware will increase the speed for all the fans within the fan module.
- Each fan connector within the module supplies a tachometer signal that allows the BMC to monitor the status of each fan. If one of the fans should fail, the fan fault LED will illuminate, the failure will be recorded to the system event log, and the remaining fans will increase to maximum speed and attempt to maintain the thermal requirements of the system.

Note: This system does not have support for redundant cooling. If a fan should fail, the system should be brought down as soon as possible to have the faulty fan replaced.

- Each fan has an associated fault LED which is controlled by the server management sub-system on the server board. The fault LEDs for each fan are located next to the fan cable connectors on the hot-swap backplane or the system fan board.

Table 21. Individual Fan Assembly Pin-out

Pin	Signal Name	Description
1	Fan Tach b	Tachometer signal from 1 st fan rotor
2	PWM	PWM control signal
3	+12V	Power Supply 12V
4	+12V	Power Supply 12V
5	Fan Tach a	Tachometer signal from 2 nd fan rotor
6	Ground	Power Supply Ground
7	Ground	Power Supply Ground
8	Not used	Not used
9	Loopback wire	Loopback to pin 10 to enable backplane presence LED functionality
10	Loopback wire	Loopback to pin 9 to enable backplane presence LED functionality

4.1.1 System Fan Board

A system fan board is used in systems configured to support fixed mount hard drives. The system fan board is used to provide power to each system fan, and used as a communication interconnect between each fan and the server board, allowing for server management to monitor and manage each fan. The system fan board also includes a fan fault LED for each system fan. The LED functionality is controlled by server management software. Should a specific system fan fail, the matching fault LED will illuminate.

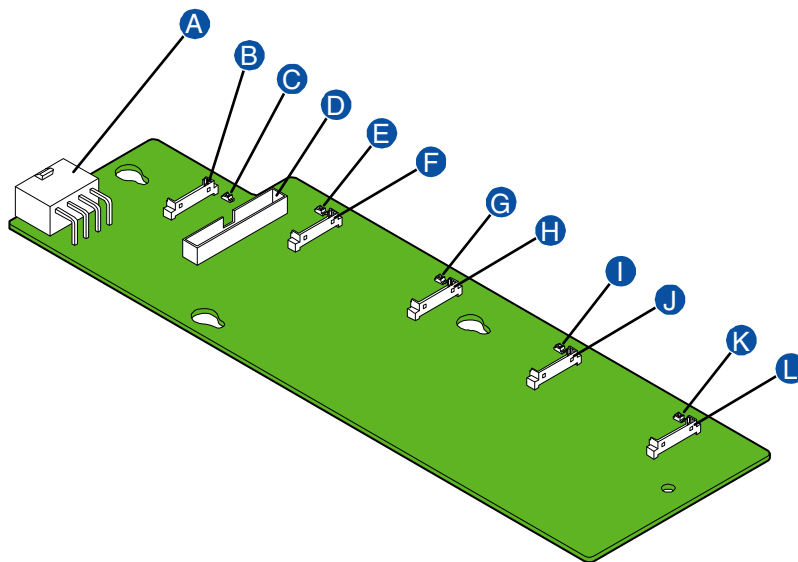

AF002158

A	Power Connector	G	Fan #3 Fault LED
B	Fan #5 Connector	H	Fan #3 connector
C	Fan #5 Fault LED	I	Fan #2 Fault LED
D	Server Board Interconnect	J	Fan #2 connector
E	Fan #4 Fault LED	K	Fan #1 Fault LED
F	Fan #4 connector	L	Fan #1 connector

Figure 13. System Fan Board

The system fan board includes a 2x13 pin header (J2A1) used as an interconnection with the server board. The header has the following pin-out.

Table 22. System Fan Board-to-Baseboard Connector (J2A1) Pin-out

Pin Definition	Pin #	Pin Definition
FAN_PWM_CPU1	1	2 FAN_PWM_CPU2
FM_FAN_D_PRSNT1_N	3	4 FAN_IO_PWM
FM_FAN_D_PRSNT3_N	5	6 FM_FAN_D_PRSNT2_N
FM_FAN_D_PRSNT5_N	7	8 FM_FAN_D_PRSNT4_N
Empty – Connector Key	9	10 LED_FAN1_FAULT
LED_FAN2_FAULT	11	12 LED_FAN3_FAULT
LED_FAN4_FAULT	13	14 LED_FAN5_FAULT
FAN_TACH1_H7	15	16 FAN_TACH2_H7
FAN_TACH3_H7	17	18 FAN_TACH4_H7
FAN_TACH5	19	20 FAN_TACH6
FAN_TACH7	21	22 FAN_TACH8

Pin Definition	Pin #		Pin Definition
PCI_FAN_TACH9	23	24	CONN_PIN24_R
PCI_FAN_TACH10	25	26	FM_SIO_TEMP_SENSOR

The system fan board includes a 2x4 power connector which is connected with the P3 power harness of the power supply. The connector has the following pin-out

Table 23. System Fan Board Power Connector (J3B1) Pin-out

Pin Definition	Pin#		Pin Definition
+12V	5	1	Ground
+12V	6	2	Ground
+5V Standby	7	3	+5V
+3.3V	8	4	+5V

4.2 Power Supply Fans

The power supply supports two non-redundant 40mm fans. They are responsible for the cooling of the power supply, first hard drive bay, and slim-line drive bay. These fans are not replaceable. Should a power supply fan fail, the entire power supply must be replaced.

4.3 CPU Air Duct and Air Baffle

The chassis requires the use of a CPU air duct and power supply/electronics bay isolation air baffle to direct airflow over critical areas within the system.

An air baffle is used to isolate airflow of the two power supply fans from that of the system fan assembly. The baffle is mounted into three stand-offs with one end fitting under the back edge of the hard drive bay.

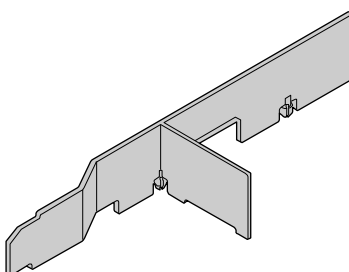

AF002194

Figure 14. Air Baffle

The CPU air duct must be properly installed to direct airflow through the processor heatsink(s) to the memory area of the system. The CPU air duct is designed to support either a single or dual processor configuration. For single processor configurations, the fabricated air dam must be left in place to prevent air from by-passing the installed processor. If the air dam is removed with only one processor installed, the system will not meet the cooling requirements of the processor, which will most likely result in a thermal shutdown of the system.

For dual processor configurations, the air dam must be snapped off of the CPU air duct. Failure to remove the air dam will prevent the installation of the air duct into the system. Once removed, the air dam cannot be re-connected to the air duct.

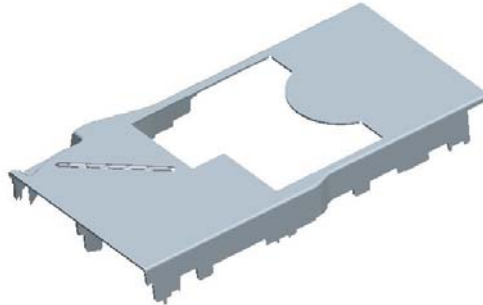

Figure 15. CPU Air Duct

Note: IMPORTANT: With only one processor installed in the system, do NOT remove the air dam from the underside of the CPU air duct. With the air dam removed, the system fans cannot provide adequate air flow through the processor heat sink, causing the processor to over heat.

Once the air dam is removed from the CPU air duct, it cannot be reinstalled.

4.4 Drive Bay Population Requirement

The hard drive bays must be populated in order to maintain system thermal requirements. Hard drive trays used for both hot-swap drives and cabled drives must either have a hard drive or drive blank installed in them. Inserting a drive tray into the system with no hard drive or drive blank installed may prevent the system from meeting its thermal requirements.

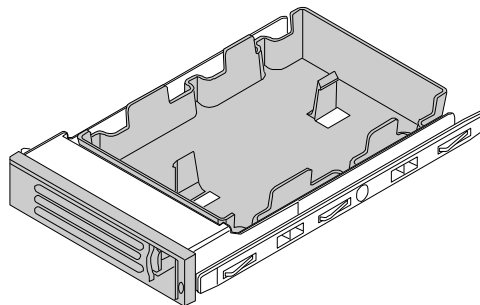

AF002196

Figure 16. Hot-Swap Hard Drive Tray with Drive Blank Installed

4.5 DIMM Slot Blanks

The use of DIMM slot blanks is required if the system is configured with up to eight x4 FBDIMMs which do NOT have an AMB thermal sensor. When using this specific FBDIMM type, the system cannot provide adequate cooling to the DIMMs, unless DIMM slot blanks are inserted in the third slot of each memory channel (Slots: A3, B3, C3, and D3).

DIMM slot blanks are not required when the system is configured with FBDIMMs that have AMB thermal sensors, or when using x8 FBDIMMS with no thermal sensors.

5. Peripheral Drive Support

The system provides a slim-line drive bay that can be populated with an IDE optical drive (CD-ROM, DVD, DVD/CDR) or a USB floppy drive. Drives are mounted on a tool-less tray which allows for easy installation into and removal from the system. The slim-line devices are not hot-swappable.

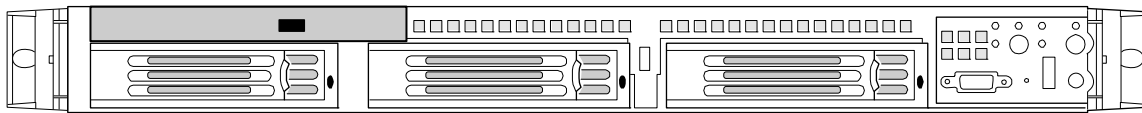

AF002198

Figure 17. View of Slim-line Drive Bay

5.1 USB Floppy Drive Support

Systems configured with a hot-swap backplane have the option to install a slim-line USB floppy drive kit (Intel Product Code AXXUSBFLOPPY). The floppy drive can be inserted into either the slim-line bay or the hard drive bay directly below the slim-line bay. The option kit includes the necessary cables and trays to support either configuration. Once inserted into the drive bay, the floppy drive is cabled to a four pin USB connector on the backplane. The following table provides the pin-out for the USB connector.

Table 24. 4-pin USB Floppy Connector Pin-out

Pin #	Pin Definition
1	Power
2	USB_P3n
3	USB P3p
4	Ground

5.2 Optical Drive Support

The system has support for a slim-line IDE optical drive. The drive is mounted onto a tool-less drive tray and is connected to an interposer card attached to the tray. The drive assembly is then inserted in to the slim-line drive bay. A 44-pin ribbon cable is used to connect the drive assembly to a matching IDE connector on the server board.

Table 25. 44-pin Internal CD-ROM Connector Pin-out

Pin Definition	Pin #	Pin #	Pin Definition
RST_IDE_S_L	1	2	GND
IDE_SDD<7>	3	4	IDE_SDD<8>
IDE_SDD<6>	5	6	IDE_SDD<9>
IDE_SDD<5>	7	8	IDE_SDD<10>
IDE_SDD<4>	9	10	IDE_SDD<11>
IDE_SDD<3>	11	12	IDE_SDD<12>
IDE_SDD<2>	13	14	IDE_SDD<13>
IDE_SDD<1>	15	16	IDE_SDD<14>
IDE_SDD<0>	17	18	IDE_SDD<15>
GND	19	20	Unused – Connector Key
IDE_SDDREQ	21	22	GND
IDE_SDIOW_L	23	24	GND
IDE_SDIOR_L	25	26	GND
IDE_SIORDY	27	28	IDEP_ALE_H
IDE_SDDACK_L	29	30	GND
IRQ_IDE_S	31	32	TP_IDEIO16_L
IDE_SDA<1>	33	34	IDE_CBL_DET_S
IDE_SDA<0>	35	36	IDE_SDA<2>
IDE_SDCS0_L	37	38	IDE_SDCS1_L
IDE_SEC_HD_ACT_L	39	40	GND
P5V	41	42	P5V
GND	43	44	GND

6. Hard Disk Drive Support

The Intel® Server System SR1560SF is available in two hard drive configurations; fixed drive SATA and hot-swap SATA/SAS. The hard drive bays are designed to support tray mounted 3.5" x 1" hard drives. Depending on the configuration, the system can either support up to two fixed mount SATA drives, or up to three hot-swap SATA or SAS drives.

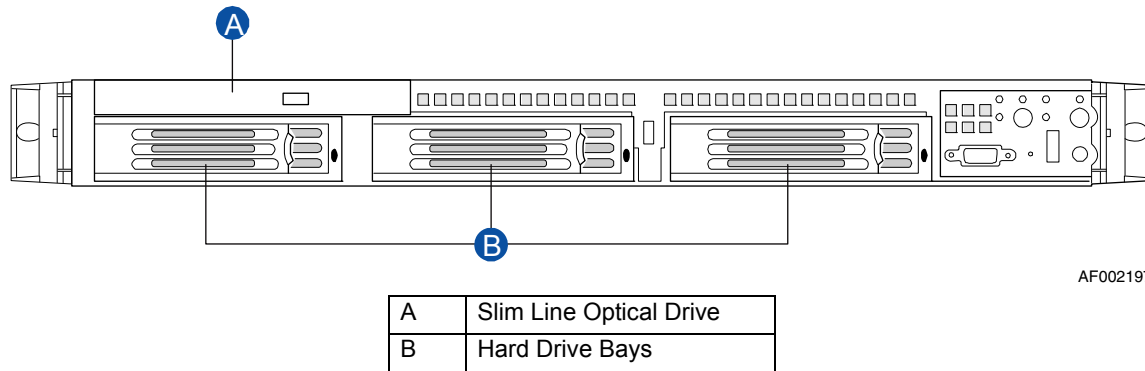

AF002197

Figure 18. Intel® Server System SR1560SF Peripheral Bay Configuration Options

6.1 Hard Drive Trays

Hard drive trays must be used for both fixed mount and hot-swap drive configurations.

In fixed mount drive configurations, the system ships with a fixed mount drive tray in each of the 3 drive bays. Only the two bays located farthest from the Control Panel will be used to support hard drives. Each installed hard drive is mounted to a fixed mount drive tray that is designed to slide into the drive bay and lock into place. To remove the drive, the chassis must be opened to disengage the drive tray latch from the bay. The third drive bay is unused in this system configuration but must be populated with a drive tray and drive blank installed.

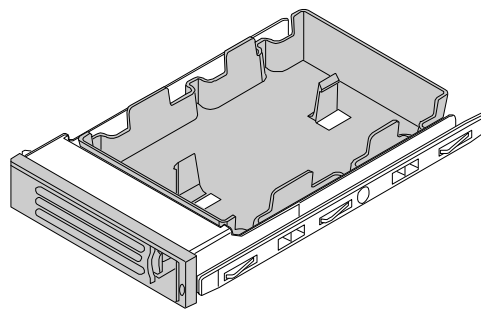

AF002196

Figure 19. Fixed Drive Tray with Drive Blank Installed

Hot-swap drive trays make insertion and extraction of the drive from the system very simple. Each drive tray has its own dual purpose latching mechanism which is used to both insert and extract drives from the chassis and lock the tray in place. Each drive tray supports a light pipe to direct light from the drive status LED on the backplane, to the tray's face plate allowing it to be viewable from the front of the system.

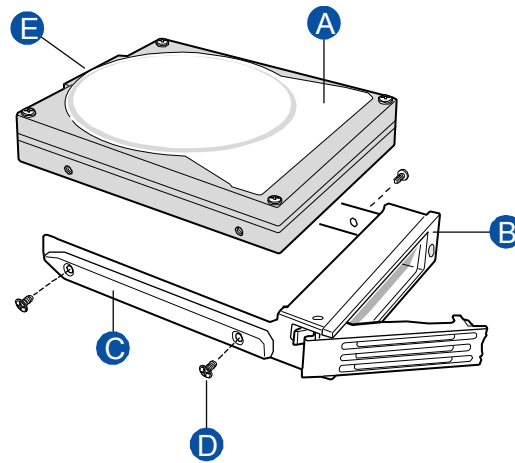

AF002199

Figure 20. Hot-Swap Hard Drive Tray Assembly

6.2 Fixed Mount Hard Drive Support

One option of the Intel® Server System SR1560SF is able to support up to two fixed mount SATA hard drives. In this configuration, there is no backplane installed. Instead, each installed hard drive is cabled to SATA ports on the server board or add-in card. Power for each installed hard drive is provided using the P5 and P6 power cable harnesses from the power supply. The third drive bay is unused in this system configuration but must be populated with a drive tray and drive blank installed.

6.3 Hot-Swap Hard Drive Support

One option of the Intel® Server System SR1560SF is able to support up to three hot-swap SATA or SAS hard drives, depending on the backplane option installed. Two backplane kits are available for use in this system; a passive SATA backplane (*Intel Product Code - ASR1500PASBP*) and an active SAS/SAS RAID backplane (*Intel Product Code - ASR1500SASBP*). Hard drives interface with the backplane through a blind mate connection when drives are installed into a hard drive bay using a hot-swap drive tray.

The passive backplane option acts as an intermediate ‘pass-through’ interface board where SATA ports of the server board or add-in SAS/SATA controller are cabled to the backplane. The active backplane requires no hard drive to controller interface cables. An on-board PCI Express* LSI* 1064-E SAS/SAS RAID controller provides the necessary drive interface.

The following sections describe the feature and connections found on both backplane options:

6.3.1 Backplane Feature set:

- Vitesse* VSC410 enclosure management controller
 - Integrated v3000 32 bit RISC microprocessor core
 - External non-volatile Flash ROM
 - Four I²C interfaces
 - 44 GPIO pins
- Three drive control connectors supporting either SATA ports from the server board or SAS/SATA ports from an add-in card (passive backplane only)
- LSI[†] LSISAS1064E SAS/SATA controller (active backplane only)
 - Four-port, 3.0 Gbit/s SAS/SATA controller
 - Integrated Arm966 microprocessor core
 - Compliant with Fusion-MPT* architecture
 - Supports Integrated RAID* technology
 - X4 PCIe* interfaces
- Support for up to three hot-swap SAS/SATA drives
- Three hard drive activity/fault LEDs
- Temperature sensor
- FRU EEPROM
- 2x4 pin power connector
- Five 1x10 pin mini system fan connectors
- 1x4 pin USB floppy drive connector
- 2x25 pin control panel I/O connector
- 1x10 pin control panel USB connector
- Add-in card I2C connector

The following diagrams show the layout of major components and connectors for each backplane.

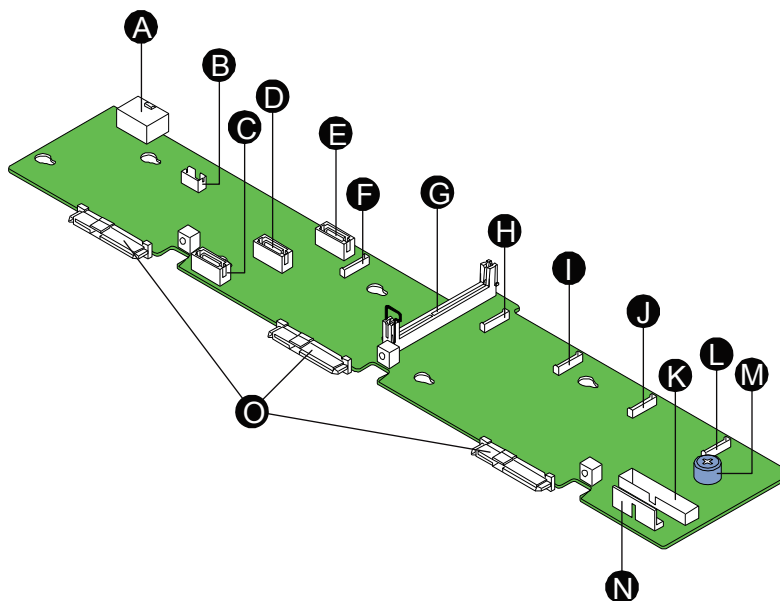

TP02171

A	Backplane Power	I	Fan 3 Power
B	USB Floppy Connector	J	Fan 2 Power
C	SATA 0	K	Front Panel Connector
D	SATA 1	L	Fan 1 Power
E	SATA 2	M	Screw
F	Fan 5 Power	N	Front Panel USB
G	Bridge Board Connector	O	SATA/SAS connectors to HDD
H	Fan 4 Power		

Figure 21. Hot-swap Passive SAS/SATA Backplane Layout

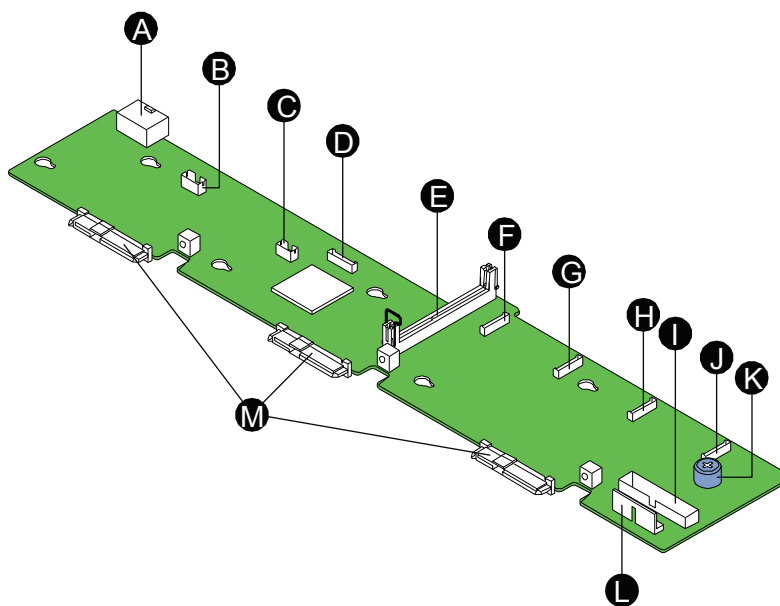

TP02172

A	Backplane Power	H	Fan 2 Power
B	USB Floppy Connector	I	Front Panel Connector
C	SW RAID Activation Key Connector	J	Fan 1 Power
D	Fan 5 Power	K	Screw
E	Bridge Board Connector	L	Front Panel USB
F	Fan 4 Power	M	SAS/SATA connectors to HDD
G	Fan 3 Power		

Figure 22. Active SAS Backplane Layout

The following figures show the functional blocks for each backplane:

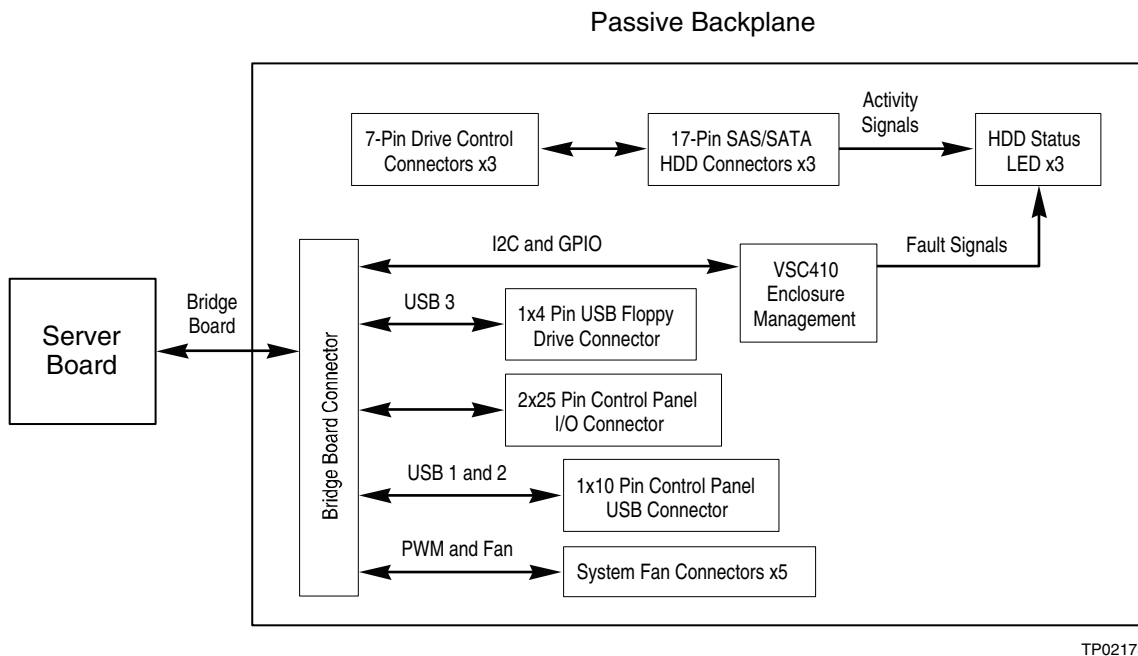

Figure 23. Hot-Swap Passive SAS/SATA Backplane Functional Diagram

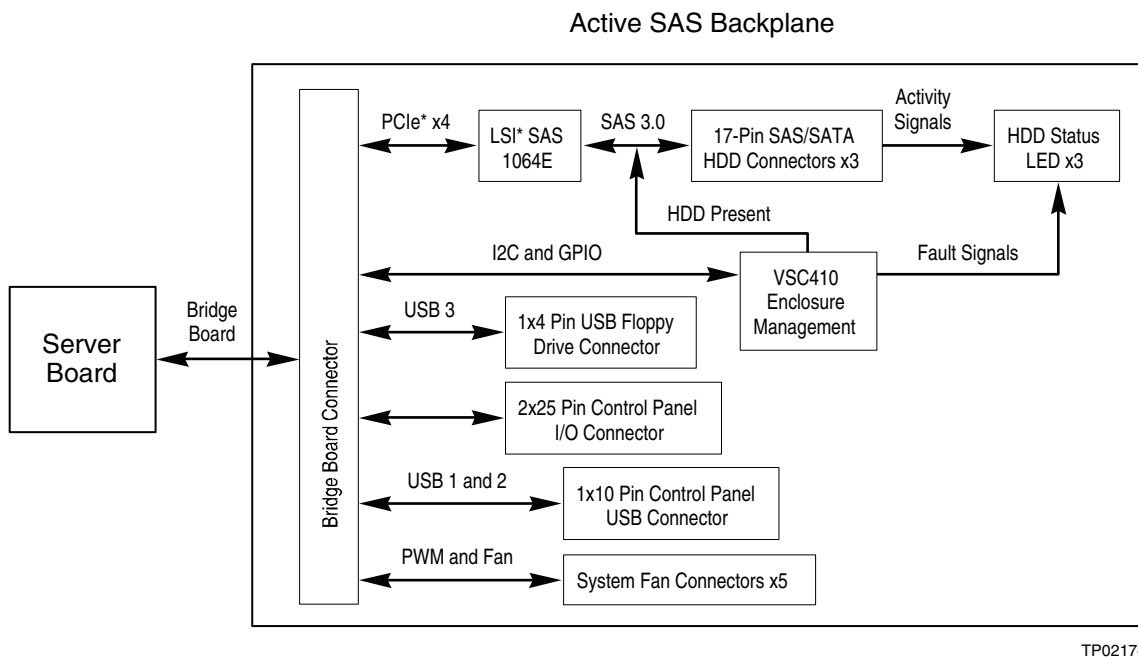

Figure 24. Hot-Swap Active SAS Backplane Functional Diagram

6.3.1.1 Vitesse* VSC410 Enclosure Management Controller

Both the active and passive backplanes support enclosure management using a Vitesse* VSC410 management controller. The VSC410 drives the hard drive activity/fault LED, hard drive present signal, and controls hard drive power up during system power on. In addition, the VSC410 supports the IPMI specification by providing management data to the baseboard management controller on the server board.

6.3.1.2 LSI* SAS1064E 3.0 Gbit/s Serial Attached SCSI Controller

Integrated on to the active SAS backplane is an LSI* SAS1064E Serial Attached SCSI (SAS) controller. The LSISAS1064E is a four-port, 3.0 Gbit/s SAS/SATA controller that is compliant with the Fusion-MPT* architecture, provides an eight-lane PCI Express* interface, and supports Intel® Embedded RAID Technology II. The point-to-point interconnect feature of the PCI Express* bus limits the electrical load on links, allowing increased transmission and reception frequencies. PCI Express* transmission and reception data rates for each full-duplex interconnect is 2.5 Gbit/s.

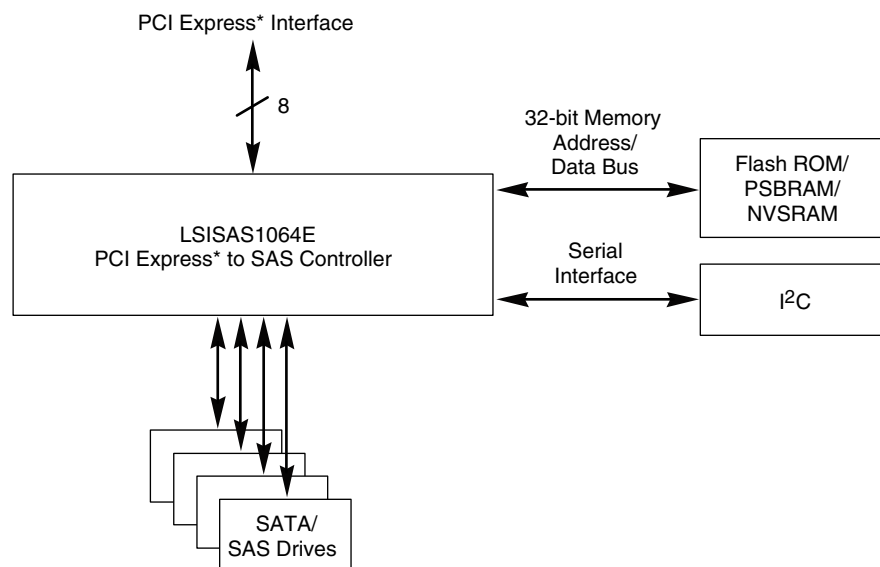

TP02175

Figure 25. LSI* SAS1064E SAS Controller Functional Diagram

PCI Express* implements a switch-based technology to interconnect a large number of devices. Communication over the serial interconnect is accomplished using a packet-based communication protocol. Quality of Service (QoS) features provide differentiated transmission performance for different applications. Hot-Plug/Hot-Swap support enables “always-on” systems. Enhanced error handling features, such as end-to-end CRC (ECRC) and Advanced Error Reporting, make PCI Express* suitable for robust, high-end server applications. Hot-Plug, power management, error handling, and interrupt signaling are accomplished using packet based messaging rather than sideband signals.

Each of the four SAS phys on the LSISAS1064E is capable of SAS/SATA link rates of 3.0 Gbit/s and 1.5 Gbit/s. The user can configure ports as wide or narrow. Narrow ports have one phy per port. Wide ports have two, three, or four phys per port. Each port supports the SSP, SMP, STP, and SATA protocols.

The SAS interface uses the proven SCSI command set to ensure reliable data transfers, while providing the connectivity and flexibility of point-to-point serial data transfers. The SAS interface provides improved performance, simplified cabling, smaller connectors, lower pin count, and lower power requirements when compared to parallel SCSI. SAS controllers leverage an electrical and physical connection interface that is compatible with Serial ATA technology.

The LSI SAS1064E supports the Intel® Embedded RAID Technology II solution, which is a highly integrated, low-cost software RAID implementation capable of supporting the following RAID levels: 0, 1, and 10. RAID level 5 is supported with the addition of an optional RAID Activation Key (iPN - AXXRAKSW5). The runtime operation of the integrated RAID solution is transparent to the operating system. A single firmware build supports all integrated RAID capabilities.

For non-RAID SAS configurations, the LSI SAS1064E uses the Fusion-MPT* (Message Passing Technology) architecture, which features a performance based message passing protocol that offloads the host CPU by completely managing all I/Os and minimizes system bus overhead by coalescing interrupts. The proven Fusion-MPT architecture requires only thin, easily developed device drivers that are independent of the I/O bus. LSI Corporation* provides these device drivers.

Features of the LSI* SAS1064E

SAS and SSP features:

- Each phy supports 3.0 Gbit/s and 1.5 Gbit/s SAS data transfers
- Provides a serial, point-to-point, enterprise-level storage interface
- Supports wide transfers consisting of 2, 3, or 4 phys
- Supports narrow ports consisting of a single phy
- Transfers data using SCSI information units
- Compatible with SATA target devices

SATA and STP Features:

- Supports 3.0 Gbits/s and 1.5 Gbits/s SATA data transfers
- Supports 3.0 Gbits/s and 1.5 Gbits/s STP data transfers

Usability features:

- Simplifies cabling with point-to-point, serial architecture
- Provides drive spin-up sequencing control
- Provides up to two LED signals for each SAS/SATA phy to indicate drive activity and faults
- Provides an SGPIO interface

6.3.2 LED Support

The backplanes support an activity/fault LED for each of the hard drive connectors. The LED will illuminate green for activity or amber for a drive fault. The green activity LED is driven by the SAS/SATA hard disk drive directly. The amber fault LED is driven by the VSC410* management controller whenever a fault condition is detected. When the drive is used in a RAID configuration, the RAID controller will have control over the fault LED and it may exhibit different behavior.

Table 26. LED Function

Status LED	Definition
Green	HDD Activity
Amber	HDD Fail

The activity LED functionality is controlled directly by the hard drives. This causes the LED to function differently between SAS and SATA drives. The expected operation is outlined below.

Table 27. Hard Drive Activity LED Functionality

Condition	Drive Type	Behavior
Power on with no drive activity	SAS	Ready LED stays on
	SATA	Ready LED stays off
Power on with drive activity	SAS	Ready LED blinks off when processing a command
	SATA	Ready LED blinks on when processing a command
Power on and drive spun down	SAS	Ready LED stays off
	SATA	Ready LED stays off
Power on and drive spinning up	SAS	Ready LED blinks
	SATA	Ready LED stays off

6.3.3 Backplane Connector Definitions

The backplanes include several different connectors. This section defines the purpose and pin-out associated with each.

6.3.3.1 Power Connector (Backplane to Power Supply Harness)

The backplane provides power to the three hard drive bays and the slim-line drive bay. An 8-pin power cable is routed from the power supply and plugs into a 2x4 shrouded plastic PC power connector on the backplane. The following table shows the power connector pin-out.

Table 28. Backplane Power Connector Pin-out (J1B1)

Pin	Name	Pin	Name
1	Ground	5	+12V
2	Ground	6	+12V
3	+5V	7	5VSB
4	+5V	8	+3.3V

6.3.3.2 Bridge Board Interface (Backplane to Server Board)

The backplanes provide a pathway for the control panel, PCIe*, USB, and other miscellaneous signals from the server board to connector interfaces on the backplane. The server board and backplane have matching 120-pin connectors which are attached using a PCB called the Bridge Board, as shown in the following figure. To assure the bridge board is held in place while the integrated platform is shipped or installed into the rack, the bridge board is held in place using metal clips which latch the bridge board to each of its connectors on the backplane and server board.

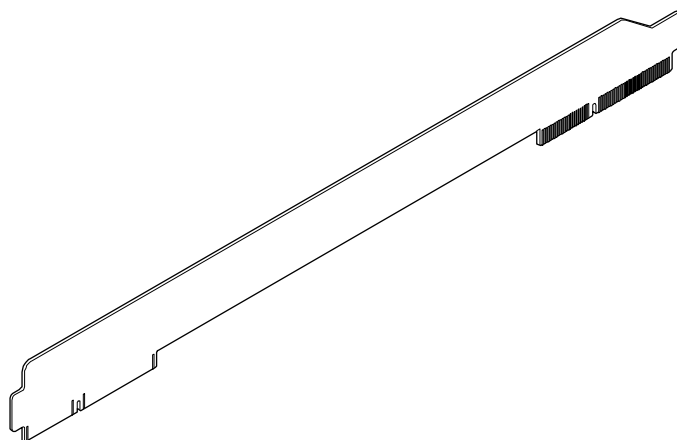

AF002201

Figure 26. Bridge Board

The following table provides the pin-out for the 120-pin connector:

Table 29. Bridge Board Connector Pin-out (J5A1)

Pin	Signal Name	Pin	Signal Name
1	GND	61	SMB_SENSOR_3V3SB_CLK_BUF
2	PE1_ESB_TX_DN3	62	SMB_SENSOR_3V3SB_DAT_BUF
3	PE1_ESB_TX_DP3	63	FM_BRIDGE_PRSNT_N
4	GND	64	GND
5	PE_WAKE_N	65	PE1_ESB_RX_DN_C3
6	GND	66	PE1_ESB_RX_DP_C3
7	PE1_ESB_TX_DN2	67	GND
8	PE1_ESB_TX_DP2	68	FAN_PRSNT6_N
9	GND	69	GND
10	FAN_PRSNT5_N	70	PE1_ESB_RX_DN_C2
11	GND	71	PE1_ESB_RX_DP_C2
12	PE1_ESB_TX_DN1	72	GND
13	PE1_ESB_TX_DP1	73	FAN_PRSNT4_N
14	GND	74	GND
15	RST_PS_PWRGD	75	PE1_ESB_RX_DN_C1
16	GND	76	PE1_ESB_RX_DP_C1
17	PE1_ESB_TX_DN0	77	GND
18	PE1_ESB_TX_DP0	78	RAID_KEY_PRES
19	GND	79	GND

Plin	Signal Name	Plin	Signal Name
20	FM_RAID_MODE	80	PE1_ESB_RX_DN_C0
21	GND	81	PE1_ESB_RX_DP_C0
22	CLK_IOP_DN	82	GND
23	CLK_IOP_DP	83	FAN_PRSENT1_N
24	GND	84	FAN_PRSENT3_N
25	SGPIO_DATAOUT1	85	FAN_PRSENT2_N
26	SGPIO_DATAOUT0	86	GND
27	SGPIO_LOAD	87	USB1_ESB_DP
28	SGPIO_CLOCK	88	USB1_ESB_DN
29	GND	89	GND
30	USB2_ESB_DP	90	USB1_ESB_OC_N
31	USB2_ESB_DN	91	USB0_ESB_OC_N
32	GND	92	GND
33	USB2_ESB_OC_N	93	USB0_ESB_DP
34	NIC1_LINK_LED_N	94	USB0_ESB_DN
35	NIC1_ACT_LED_N	95	GND
36	LED_STATUS_AMBER_R1	96	FP_NMI_BTN_N
37	NIC2_LINK_LED_N	97	BMC_RST_BTN_N
38	NIC2_ACT_LED_N	98	FP_PWR_BTN_N
39	LED_STATUS_GREEN_BUF_R1	99	FP_ID_SW_L
40	GND	100	GND
41	SMB_PBI_5VSB_DAT	101	SMB_IPMB_5VSB_DAT
42	SMB_PBI_5VSB_CLK	102	SMB_IPMB_5VSB_CLK
43	GND	103	GND
44	V_IO_HSYNC2_BUF_FP	104	LED_HDD_ACTIVITY_N
45	V_IO_VSYNC2_BUF_FP	105	LED_HDD_5V_A
46	GND	106	FP_PWR_LED_R_N
47	V_IO_BLUE_CONN_FP	107	FP_PWR_LED_3VSB
48	V_IO_GREEN_CONN_FP	108	FP_ID_LED_R1_N
49	V_IO_RED_CONN_FP	109	FM_SIO_TEMP_SENSOR
50	GND	110	LED_FAN3_FAULT
51	LED_FAN6_FAULT	111	LED_FAN2_FAULT
52	LED_FAN5_FAULT	112	LED_FAN1_FAULT
53	LED_FAN4_FAULT	113	FAN_PWM_CPU1
54	FAN_PWM3	114	GND
55	GND	115	FAN_PWM_CPU2
56	PCI_FAN_TACH10	116	PCI_FAN_TACH9
57	FAN_TACH8	117	FAN_TACH7
58	FAN_TACH6	118	FAN_TACH5
59	FAN_TACH4_H7	119	FAN_TACH3_H7
60	FAN_TACH2_H7	120	FAN_TACH1_H7

6.3.3.3 Control Panel I/O Interface Connector (Backplane to Control Panel)

The backplanes provide a pathway for control panel I/O signals from the bridge board connector to the control panel interface connector. The pin-out for the 50-pin control panel I/O connector is shown in the following table:

Table 30. Backplane Control Panel Connector Pin-out (J9C1)

Description	Pin #	Pin #	Description
V_IO_RED_CONN_FP	1	2	GND
V_IO_GREEN_CONN_FP	3	4	GND
V_IO_BLUE_CONN_FP	5	6	GND
V_IO_HSYNC_BUFF_FP_L	7	8	GND
V_IO_VSYNC_BUFF_FP_L	9	10	GND
VIDEO_IN_USE	11	12	FP_THERM_SENSOR
EMP_DTR2_L	13	14	EMP_DCD2_L
EMP_RTS2_L	15	16	EMP_CTS2_L
EMP_SIN2_L	17	18	EMP_SOUT2
EMP_DSR2_L	19	20	EMP_IN_USE
FP_NMI_BTN_L	21	22	GND
NIC1_ACT_LED_L	23	24	NIC1_LINK_LED_R_L
	25	26	FP_CHASSIS_INTRU
FP_ID_SW_L	27	28	SMB_PB1_5VSB_CLK
GND	29	30	SMB_PB1_5VSB_DAT
FP_RST_BTN_L	31	32	NIC2_ACT_LED_L
HDD_FAULT_LED_R_L	33	34	NIC2_LINK_LED_R_L
FP_PWR_BTN_L	35	36	FP_ID_LED_R_L
IPMB_I2C_5VSB_SCL	37	38	GND
IPMB_I2C_5VSB_SDA	39	40	HDD_LED_5V_A
FP_PWR_LED_R_N	41	42	FAULT_LED_5VSB_P
FP_PWR_LED_5VSB	43	44	LED_STATUS_AMBER_R1
RST_P6_PWRGOOD	45	46	LED_STATUS_GREEN_BUF_R1
HDD_LED_ACT_R_L	47	48	P5V
P5V_STBY	49	50	P5V_STBY

6.3.3.4 Control Panel USB Interface Connector (Backplane to Control Panel)

The backplanes provide a pathway for control panel USB signals from the bridge board connector to the control panel USB interface connector. The pin-out for the 10-pin control panel USB connector is shown in the following table.

Table 31. 1x10 Pin Control Panel USB Connector Pin-out (J6B1)

Pin#	Description
1	P5V_USB_P1
2	USB_P1N
3	USB_P1P
4	GROUND
5	GROUND
6	P5V_USB_P2
7	USB_P2N
8	USB_P2P
9	GROUND
10	GROUND

6.3.3.5 Hot-Swap SATA/SAS Drive Connectors

The backplanes provide three hot-swap SATA/SAS connectors, which provide power and signals using a single docking connector. Each drive attaches to the backplane using one of these connectors.

Table 32. SAS/SATA Hard Drive Connector Pin-out (J8N1, J6N1, J3N1)

Pin#	Signal Description
S1	Ground
S2	SAS#_TX_DP (# = 0...2)
S3	SAS#_TX_DN (# = 0...2)
S4	Ground
S5	SAS#_RX_DN (# = 0...2)
S6	SAS#_RX_DP (# = 0...2)
S7	Ground
S8	Not Used
S9	Not Used
S10	Not Used
S11	Not Used
S12	Not Used
S13	Not Used
S14	Not Used
P1	Not Used
P2	Not Used
P3	Not Used
P4	Ground
P5	Ground
P6	P3V3
P7	P5V
P8	P5V
P9	P5V
P10	Ground
P11	LED_SAS#_ACT_L (# = 0...2)
P12	Ground
P13	P12V
P14	P12V
P15	P12V
PTH0	Ground
PTY1	Ground

6.3.3.6 SATA/SAS Drive Control Connectors (Passive Backplane Only)

The passive backplane includes three drive control connectors. These are used to attach SATA/SAS cables from the backplane to either the SATA ports on the server board, or to SAS/SATA ports from an add-in card. Each drive control connector has the following pin-out.

Table 33. SATA/SAS Drive Control Connector Pin-out (J3C1, J4B2, J4A1)

Pin#	Description
1	GROUND
2	SATA # TX_DP (# = 0,1,2)
3	SATA # TX_DN (# = 0,1,2)
4	GROUND
5	SATA # RX_DN (# = 0,1,2)
6	SATA # RX_DP (# = 0,1,2)
7	GROUND

6.3.3.7 USB Floppy Drive Connector

With a slim-line USB floppy drive installed (using the optional floppy drive kit) into either the slim-line drive bay or in one of the hard drive bays, the USB floppy cable is routed from the drive to a 4-pin connector on the backplane. The following table provides the pin-out for the floppy drive connector.

Table 34. 4-pin Floppy Connector Pin-out (J2B1)

Pin#	Name
1	P5V_USB_P3
2	USBP3N
3	USBP3P
4	GROUND

6.3.3.8 System Fan Connectors

The backplanes provides a pathway for signals from the server board to monitor and control five system fans. A 1x10 mini connector is provided for each of the fans. The pin-out for each connector is provided in the following table.

Table 35. System Fan Connector Pin-outs

J9A5 - FAN_1		J8A1 - FAN_2		J7A1 - FAN_3	
PIN	SIGNAL NAME	PIN	SIGNAL NAME	PIN	SIGNAL NAME
1	FAN_TACH5	1	FAN_TACH6	1	FAN_TACH7
2	FAN_PWM_CPU1	2	FAN_PWM_CPU1	2	FAN_PWM_CPU2
3	P12V	3	P12V	3	P12V
4	P12V	4	P12V	4	P12V
5	FAN_TACH1_H7	5	FAN_TACH2_H7	5	FAN_TACH3_H7
6	GND	6	GND	6	GND
7	GND	7	GND	7	GND
8	FAN_PRSNT1_N	8	FAN_PRSNT2_N	8	FAN_PRSNT3_N
9	LED_FAN1_FAULT	9	LED_FAN2_FAULT	9	LED_FAN3_FAULT
10	LED_FAN1	10	LED_FAN2	10	LED_FAN3

J6A1 - FAN_4		J4B1 - FAN_5		
PIN	SIGNAL NAME	PIN	SIGNAL NAME	
1	FAN_TACH8	1	PCI_FAN_TACH10	
2	FAN_PWM_CPU2	2	FAN_PWM3	
3	P12V	3	P12V	
4	P12V	4	P12V	
5	FAN_TACH4_H7	5	FAN_TACH9	
6	GND	6	GND	
7	GND	7	GND	
8	FAN_PRSNT4_N	8	FAN_PRSNT5_N	
9	LED_FAN4_FAULT	9	LED_FAN5_FAULT	
10	LED_FAN4	10	LED_FAN5	

6.3.3.9 System Management Connectors

The backplanes provide connectors to interface with system management buses. The following tables define the pin-out for each of these connectors:

Table 36. IPMB Connector Pin-out (J1C1)

Pin #	Description
1	SMB_IPMB_5VSB_DAT
2	GND
3	SMB_IPMB_5VSB_CLK
4	SMB_PWR_IPMB_CONN

Table 37. Add-in Card Connector Pin-out (J4B3 – Passive Only)

Pin #	Description
1	SMB_3V3_SAS_SDA
2	GND
3	SMB_3V3_SAS_SCL

7. Standard Control Panel Functionality

The Intel® Server System SR1560SF can support either of two standard control panels; one each for the fixed drive and hot-swap backplane configurations. The control panel assemblies are pre-assembled and modular in design. The entire module assembly slides into a predefined slot in the front of the chassis.

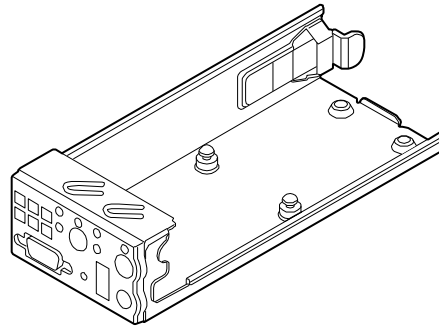

AF002202

Figure 27. Control Panel Module

For fixed drive configurations, the standard control panel supports several push buttons and status LEDs, along with a single USB 2.0 port to centralize system control, monitoring, and accessibility to within a common compact design. The following diagram overviews the layout and functions of the control panel.

Note: This control panel option has no video

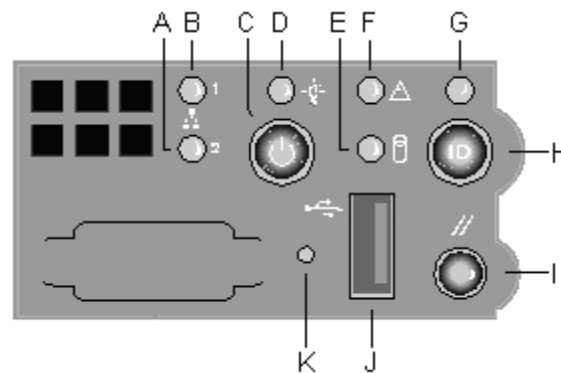

A	NIC 2 Activity LED	G	System Identification LED
B	NIC 1 Activity LED	H	System Identification Button
C	Power/Sleep Button	I	System Reset Button
D	Power/Sleep LED	J	USB 2.0 Connector
E	Hard Drive Activity LED	K	Recessed NMI Button (Tool Required)
F	System Status LED		

Figure 28. Control Panel Overview Without Video

For systems configured with a hot-swap backplane, the standard control panel supports several push buttons and status LEDs, along with USB and video ports to centralize system control, monitoring, and accessibility to within a common compact design. The following diagram overviews the layout and functions of the control panel.

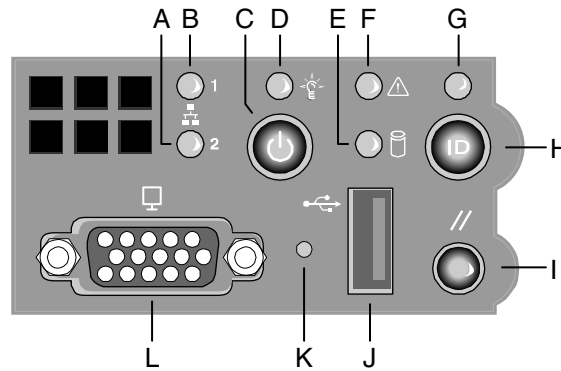

AF002189

A	NIC 2 Activity LED	G	System Identification LED
B	NIC 1 Activity LED	H	System Identification Button
C	Power/Sleep Button	I	System Reset Button
D	Power/Sleep LED	J	USB 2.0 Connector
E	Hard Drive Activity LED	K	Recessed NMI Button (Tool Required)
F	System Status LED	L	Video Connector

Figure 29. Standard Control Panel Overview

The following sections described the features of the standard control panels. Differences between control panels for the fixed hard drive and hot-swap hard drive configurations will be noted.

7.1 Control Panel Buttons

The standard control panel assembly houses several system control buttons. Each of their functions is listed in the table below.

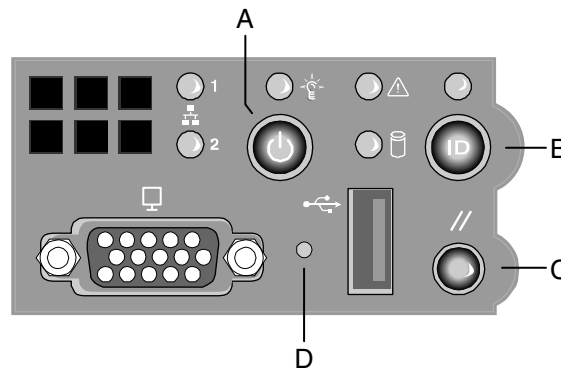

AF002203

Figure 30. Control Panel Buttons

Table 38. Control Button and Intrusion Switch Functions

Reference	Feature	Function
A	Power/Sleep Button	Toggles the system power on/off. This button also functions as a Sleep Button if enabled by an ACPI-compliant operating system.
B	ID Button	Toggles the front panel ID LED and the baseboard ID LED on/off. The baseboard ID LED is visible through the rear of the chassis and allows you to locate the server you're working on from behind a rack of servers.
C	Reset Button	Reboots and initializes the system.
D	NMI Button	Pressing the recessed button with a paper clip or pin puts the server in a halt state for diagnostic purposes and allows you to issue a non-maskable interrupt. After issuing the interrupt, a memory download can be performed to determine the cause of the problem.

7.2 Control Panel LED Indicators

The control panel houses six LEDs, which are viewable with or without the front bezel to display the system's operating state.

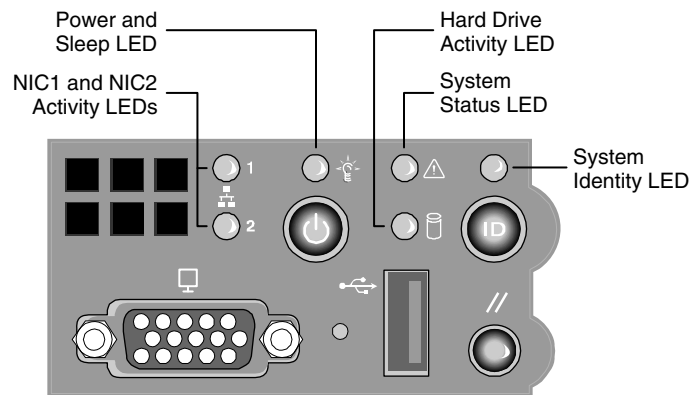

AF002204

Figure 31. Control Panel LED Indicators

The following table identifies each LED and describes their functionality.

Table 39. Control Panel LED Functions

LED	Color	State	Description
NIC1/NIC2 Activity	Green	On	NIC Link
	Green	Blink	NIC Activity
Power/Sleep (on standby power)	Green	On	Legacy power on/ACPI S0 state
		Blink ^{1,4}	Sleep/ACPI S1 state
	Off	Off	Power Off/ACPI S4 or S5 state
System Status (on standby power)	Green/Amber	Alternating Blink	Pre DC Power On – 15-20 second BMC Initialization
	Green	On	Running/normal operation
		Blink ^{1,2}	Degraded
	Amber	On	Critical or non-recoverable condition.
		Blink ^{1,2}	Non-critical condition.
	Off	Off	POST/system stop.
Disk Activity	Green	Random blink	Provides an indicator for disk activity.

LED	Color	State	Description
	Off	Off ³	No hard disk activity
System Identification	Blue	On	Identify active via command or button.
	Off	Off	No Identification.

Notes:

1. Blink rate is ~1 Hz with at 50% duty cycle.
2. The amber status takes precedence over the green status. When the amber LED is on or blinking, the green LED is off.
3. Also off when the system is powered off (S4/S5) or in a sleep state (S1).
4. The power LED sleep indication is maintained on standby by the chipset. If the system is powered down without going through BIOS, the LED state in effect at the time of power off will be restored when the system is powered on until the BIOS clears it. If the system is not powered down normally, it is possible that the Power LED will be blinking at the same time that the system status LED is off due to a failure or configuration change that prevents the BIOS from running.

The current limiting resistors for the power LED, the system fault LED, and the NIC LEDs are located on the Intel® Server Board “S5300SF”.

7.2.1 Power/Sleep LED

Table 40. SSI Power LED Operation

State	Power Mode	LED	Description
Power Off	Non-ACPI	Off	System power is off, and the BIOS has not initialized the chipset.
Power On	Non-ACPI	On	System power is on, but the BIOS has not yet initialized the chipset.
S5	ACPI	Off	Mechanical is off, and the operating system has not saved any context to the hard disk.
S4	ACPI	Off	Mechanical is off. The operating system has saved context to the hard disk.
S3-S1	ACPI	Slow blink 1	DC power is still on. The operating system has saved context and gone into a level of low-power state.
S0	ACPI	Steady on	System and the operating system are up and running.

Note:

Blink rate is ~ 1Hz with at 50% duty cycle.

7.2.2 System Status LED

Table 41. Control Panel LED Operation

Color	State	Criticality	Description
Off	N/A	Not ready	AC power off
Green/ Amber	Alternating Blink	Not ready	Pre DC Power On – 15-20 second BMC Initialization when AC is applied to the server. Control Panel buttons are disabled until BMC initialization is complete.
Green	Solid on	Ok	System booted and ready
Green	Blink	Degraded	System degraded Unable to use all of the installed memory (more than one DIMM installed). Correctable errors over a threshold of 10 and migrating to a spare DIMM (memory sparing). This indicates that the user no longer has spared DIMMs indicating a redundancy lost condition. Corresponding DIMM LED should light up.

Color	State	Criticality	Description
			<p>In mirrored configuration, when memory mirroring takes place and system loses memory redundancy. This is not covered by (2).</p> <p>Redundancy loss such as power-supply or fan. This does not apply to non-redundant sub-systems.</p> <p>PCIe* link errors</p> <p>CPU failure/disabled – if there are two processors and one of them fails</p> <p>Fan alarm – Fan failure. Number of operational fans should be more than minimum number needed to cool the system</p> <p>Non-critical threshold crossed – Temperature and voltage</p>
Amber	Blink	Non-critical	<p>Non-fatal alarm – system is likely to fail</p> <p>Critical voltage threshold crossed</p> <p>VRD hot asserted</p> <p>Minimum number of fans to cool the system not present or failed</p> <p>In non-sparing and non-mirroring mode if the threshold of ten correctable errors is crossed within the window</p>
Amber	Solid on	Critical, non-recoverable	<p>Fatal alarm – system has failed or shutdown</p> <p>DIMM failure when there is one DIMM present, no good memory present</p> <p>Run-time memory uncorrectable error in non-redundant mode</p> <p>IERR signal asserted</p> <p>Processor 1 missing</p> <p>Temperature (CPU ThermTrip, memory TempHi, critical threshold crossed)</p> <p>No power good – power fault</p> <p>Processor configuration error (for instance, processor stepping mismatch)</p>

7.2.2.1 System Status LED – BMC Initialization

When AC power is first applied to the system and 5V-STBY is present, the BMC controller on the server board requires 15-20 seconds to initialize. During this time, the system status LED will blink, alternating between amber and green, and the power button functionality of the control panel is disabled, preventing the server from powering up. Once BMC initialization has completed, the status LED will stop blinking and the power button functionality is restored and can be used to turn on the server.

7.2.3 Drive Activity LED

The drive activity LED on the control panel indicates drive activity from the onboard hard disk controllers.

7.2.4 System Identification LED

The blue system identification LED is used to help identify a system for servicing. This is especially useful when the system is installed in a high density rack or cabinet that is populated with several similar systems.

The blue “System ID” LED can be illuminated using either of the following two mechanisms:

- By pressing the system ID button on the system control panel the ID LED will display a solid blue color, until the button is pressed again.
- By issuing the appropriate hex IPMI “Chassis Identify” value, the ID LED will either blink blue for 15 seconds and turn off or will blink indefinitely until the appropriate hex IPMI Chassis Identify value is issued to turn it off.

7.3 Control Panel Connectors

The control panel has two external I/O connectors:

- One USB port
- One VGA video port (backplane configurations only)

The following tables provide the pin-outs for each connector:

Table 42. External USB Connectors (J1B1)

Pin #	Description
1	PWR_FP_USB2
2	USB_DN2_FP_R
3	USB_DP2_FP_R
4	GND
5	GND
6	GND
7	GND

Table 43. Video Connector (J1A1)

Description	Pin #	Pin #	Description
VGA_RED	1	9	GND
VGA_GREEN	2	10	GND
VGA_BLUE	3	11	Unused
Unused	4	12	VGA_DDCDAT
GND	5	13	VGA_HSYNC_L
GND	6	14	VGA_VSYNC_L
VGA_INUSE_L	7	15	VGA_DDCCLK
GND	8	16	GND
		17	GND

If a monitor is connected to the front panel video connector, the rear video port on the server board will be disabled and the front panel video will be enabled. The video source is the same for both connectors and is switched between the two, with the control panel having priority over the rear video. This provides for easy front accessibility to the server.

8. PCI Riser Card and Assembly

The Intel® Server System S1560SF provides one x16 PCI Express* Gen 2 PCI riser slot supporting a one slot x16 PCI Express* riser card capable of supporting full length full height PCI Express* add-in cards.

When re-inserting the riser assembly into the chassis, tabs on the back of the assembly should be aligned with slots on the back edge of the chassis. The tabs fit into the slots securing the riser assembly to the chassis when the top cover is in place.

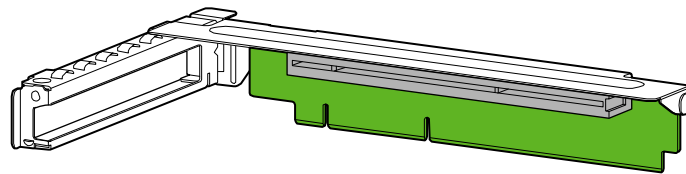

AF002207

Figure 32. PCI Riser Card Assembly

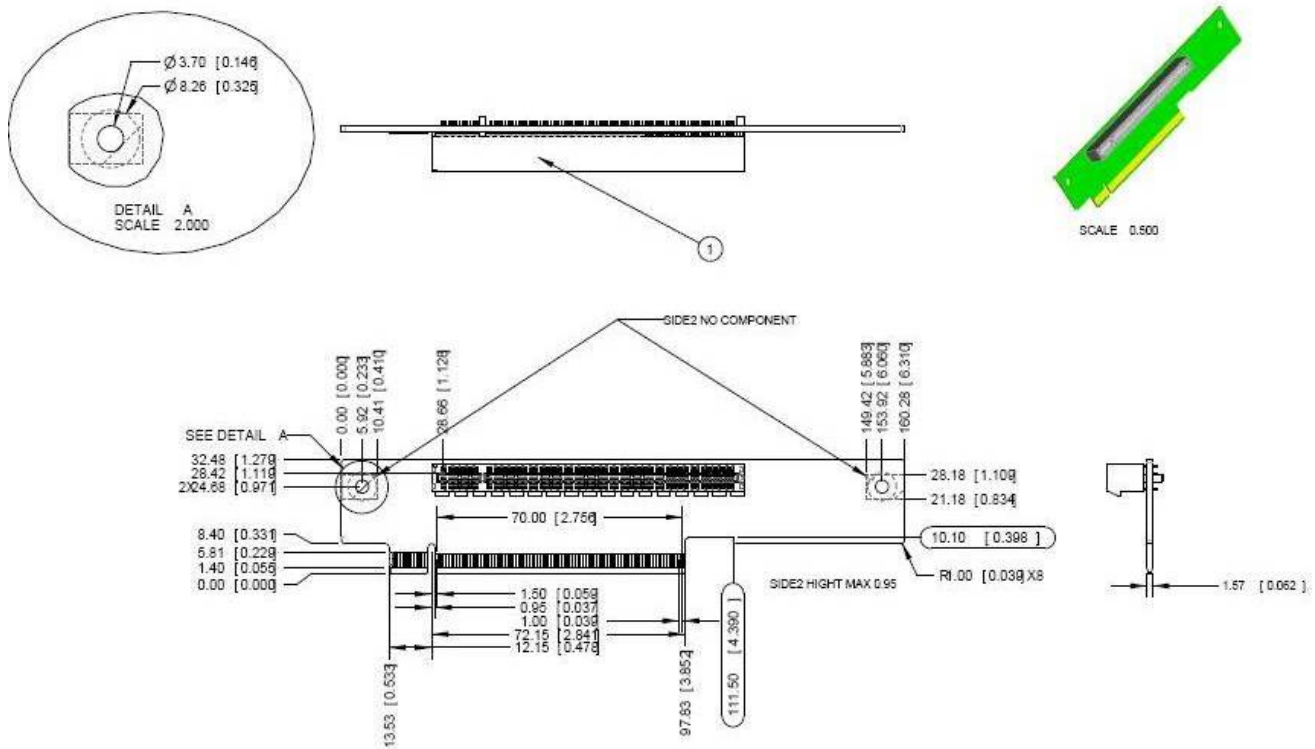

Figure 33. 1U Full Height PCI Express* Riser Card Mechanical Drawing

9. Environmental and Regulatory Specifications

9.1 System Level Environmental Limits

The table below defines the system level operating and non-operating environmental limits:

Table 44. System Environmental Limits Summary

Parameter	Limits
Operating Temperature	10° C to 35° C (50° F to 90° F) with the maximum rate of change not to exceed 10 C per hour
Non-Operating Temperature	-40 C to +70 C
Non-Operating Humidity	90%, non-condensing @ 28 C
Acoustic noise	Sound Pressure: 55 dBA (Rack mount) in an idle state at typical office ambient temperature. (23 +/- degrees C) Sound Power: 7.0 BA in an idle state at typical office ambient temperature. (23 +/- 2 degrees C)
Shock, operating	Half sine, 2 g peak, 11 mSec
Shock, unpackaged	Trapezoidal, 25 g, velocity change 136 inches/sec (□40 lbs to > 80 lbs)
Shock, packaged	Non-palletized free fall in height 24 inches (□40 lbs to > 80 lbs)
Vibration, unpackaged	5 Hz to 500 Hz, 2.20 g RMS random
Shock, operating	Half sine, 2 g peak, 11 mSec
ESD	+/-15kV except I/O port +/-8KV per Intel Environmental test specification
System Cooling Requirement in BTU/Hr	2550 BTU/hour

9.2 Serviceability and Availability

The system is designed to be serviced by qualified technical personnel only.

The desired Mean Time To Repair (MTTR) the system is 30 minutes including diagnosis of the system problem. To meet this goal, the system enclosure and hardware have been designed to minimize the MTTR.

Following are the maximum times that a trained field service technician should take to perform the listed system maintenance procedures, after diagnosis of the system and having identified the failed component:

Activity	Time Estimate
Remove and replace top cover	< 1 min
Remove and replace hard disk drive – includes replacing drive in drive tray	5 min
Remove and replace power supply	3 min
Remove and replace system fan	3 min
Remove and replace backplane board	10 min
Remove and replace control panel module	2 min
Remove and replace server board	15 min

9.3 Replacing the Back up Battery

The lithium battery on the server board powers the real time clock (RTC) for up to 10 years in the absence of power. When the battery starts to weaken, it loses voltage, and the server settings stored in CMOS RAM in the RTC (for example, the date and time) may be wrong. Contact your customer service representative or dealer for a list of approved devices.



WARNING

Danger of explosion if battery is incorrectly replaced. Replace only with the same or equivalent type recommended by the equipment manufacturer. Discard used batteries according to manufacturer's instructions.



ADVARSEL!

Lithiumbatteri - Eksplosjonsfare ved feilagtig håndtering. Utskiftning må kun ske med batteri af samme fabrikat og type. Levér det brugte batteri tilbage til leverandøren.



ADVARSEL

Lithiumbatteri - Eksplosjonsfare. Ved utskifting benyttes kun batteri som anbefalt av apparatfabrikanten. Brukt batteri returneres apparatleverandøren.



WARNING

Explosionsfara vid felaktigt batteribyte. Använd samma batterityp eller en ekvivalent typ som rekommenderas av apparattillverkaren. Kassera använt batteri enligt fabrikantens instruktion.



VAROITUS

Paristo voi räjähtää, jos se on virheellisesti asennettu. Vaihda paristo ainoastaan laitevalmistajan suositteluun tyyppiin. Hävitä käytetty paristo valmistajan ohjeiden mukaisesti.

9.4 Product Regulatory Compliance

The server chassis product, when correctly integrated per this guide, complies with the following safety and electromagnetic compatibility (EMC) regulations.

Intended Application – This product was evaluated as Information Technology Equipment (ITE), which may be installed in offices, schools, computer rooms, and similar commercial type locations. The suitability of this product for other product categories and environments (such as: medical, industrial, telecommunications, NEBS, residential, alarm systems, test equipment, etc.), other than an ITE application, may require further evaluation.

Notifications to Users on Product Regulatory Compliance and Maintaining Compliance – To ensure regulatory compliance, you must adhere to the assembly instructions in this guide to ensure and maintain compliance with existing product certifications and approvals. Use only the described, regulated components specified in this guide. Use of other products/components will void the UL listing and other regulatory approvals of the product and will most likely result in noncompliance with product regulations in the region(s) in which the product is sold.

To help ensure EMC compliance with your local regional rules and regulations, before computer integration, make sure that the chassis, power supply, and other modules have passed EMC testing using a server board with a microprocessor from the same family (or higher) and operating at the same (or higher) speed as the microprocessor used on this server board. The final configuration of your end system product may require additional EMC compliance testing. For more information please contact your local Intel Representative. This is an FCC Class A device and its use is intended for a commercial type market place.

9.5 Use of Specified Regulated Components

To maintain the UL listing and compliance to other regulatory certifications and/or declarations, the following regulated components must be used and conditions adhered to. Interchanging or use of other component will void the UL listing and other product certifications and approvals.

Updated product information for configurations can be found on the Intel Server Builder Web site at the following URL:

<http://channel.intel.com/go/serverbuilder>.

If you do not have access to Intel's Web address, please contact your local Intel representative.

Server chassis – (base chassis is provided with power supply and fans) – UL listed.

Server board – you must use an Intel server board – UL recognized.





Add-in boards – must have a printed wiring board flammability rating of minimum UL94V-1. Add-in boards containing external power connectors and/or lithium batteries must be UL recognized or UL listed. Any add-in board containing modem telecommunication circuitry must be UL listed. In addition, the modem must have the appropriate telecommunications, safety, and EMC approvals for the region in which it is sold.



Peripheral Storage Devices – must be UL recognized or UL listed accessory and TUV or VDE licensed. Maximum power rating of any one device or combination of devices can not exceed manufacturer's specifications. Total server configuration is not to exceed the maximum loading conditions of the power supply.

The following table references Server Chassis Compliance and markings that may appear on the product. Markings below are typical markings however, may vary or be different based on how certification is obtained.

Note: Certifications Emissions requirements are to Class A.

Table 45. Product Safety & Electromagnetic (EMC) Compliance

Compliance Regional Description	Compliance Reference	Compliance Reference Marking Example
Australia/New Zealand	AS/NZS 3548 (Emissions)	 N232
Argentina	IRAM Certification (Safety)	
Belarus	Belarus Certification	None Required
Canada/USA	CSA 60950 – UL 60950 (Safety)	
	Industry Canada ICES-003 (Emissions)	CANADA ICES-003 CLASS A CANADA NMB-003 CLASSE A
	FCC CFR 47, Part 15 (Emissions)	This device complies with Part 15 of the FCC Rules. Operation of this device is subject to the following two conditions: (1) This device may not cause harmful interference, and (2) This device must accept interference receive, including interference that may cause undesired operation.
CENELEC Europe	Low Voltage Directive 93/68/EEC; EMC Directive 89/336/EEC EN55022 (Emissions) EN55024 (Immunity) EN61000-3-2 (Harmonics) EN61000-3-3 (Voltage Flicker) CE Declaration of Conformity	
Germany	GS Certification – EN60950	
International	CB Certification – IEC60950 CISPR 22/CISPR 24	None Required
Japan	VCCI Certification	この装置は、クラス A 情報技術装置です。この装置を家庭環境で使用すると電波妨害を引き起こすことがあります。この場合には使用者が適切な対策を講ずるよう要求されることがあります。VCCI-A
Korea	RRL Certification MIC Notice No. 1997-41 (EMC) & 1997-42 (EMI)	 인증번호: CPU-Model Name (A)

Compliance Regional Description	Compliance Reference	Compliance Reference Marking Example
Russia	GOST-R Certification GOST R 29216-91 (Emissions) GOST R 50628-95 (Immunity)	
Ukraine	Ukraine Certification	None Required
Taiwan	BSMI CNS13438	 R33025 <div style="border: 1px solid black; padding: 2px; width: fit-content;"> <p>警告使用者： 這是甲類的資訊產品，在居住的環境中使用時，可能會造成射頻干擾，在這種情況下，使用者會被要求採取某些適當的對策</p> </div>

9.6 Electromagnetic Compatibility Notices

9.6.1 USA

This device complies with Part 15 of the FCC Rules. Operation is subject to the following two conditions: (1) this device may not cause harmful interference, and (2) this device must accept any interference received, including interference that may cause undesired operation.

For questions related to the EMC performance of this product, contact:

Intel Corporation
5200 N.E. Elam Young Parkway
Hillsboro, OR 97124
1-800-628-8686

This equipment has been tested and found to comply with the limits for a Class A digital device, pursuant to Part 15 of the FCC Rules. These limits are designed to provide reasonable protection against harmful interference in a residential installation. This equipment generates, uses, and can radiate radio frequency energy and, if not installed and used in accordance with the instructions, may cause harmful interference to radio communications. However, there is no guarantee that interference will not occur in a particular installation. If this equipment does cause harmful interference to radio or television reception, which can be determined by turning the equipment off and on, the user is encouraged to try to correct the interference by one or more of the following measures:

- Reorient or relocate the receiving antenna.
- Increase the separation between the equipment and the receiver.
- Connect the equipment to an outlet on a circuit other than the one to which the receiver is connected.
- Consult the dealer or an experienced radio/TV technician for help.

Any changes or modifications not expressly approved by the grantee of this device could void the user's authority to operate the equipment. The customer is responsible for ensuring compliance of the modified product.

Only peripherals (computer input/output devices, terminals, printers, etc.) that comply with FCC Class B limits may be attached to this computer product. Operation with noncompliant peripherals is likely to result in interference to radio and TV reception.

All cables used to connect to peripherals must be shielded and grounded. Operation with cables, connected to peripherals that are not shielded and grounded may result in interference to radio and TV reception.

9.6.2 FCC Verification Statement

Product Type: SR1560SF

This device complies with Part 15 of the FCC Rules. Operation is subject to the following two conditions: (1) This device may not cause harmful interference, and (2) this device must accept any interference received, including interference that may cause undesired operation.

For questions related to the EMC performance of this product, contact:

Intel Corporation
5200 N.E. Elam Young Parkway
Hillsboro, OR 97124-6497

Phone: 1 (800)-INTEL4U or 1 (800) 628-8686

9.6.3 ICES-003 (Canada)

Cet appareil numérique respecte les limites bruits radioélectriques applicables aux appareils numériques de Classe A prescrites dans la norme sur le matériel brouilleur: "Appareils Numériques", NMB-003 édictée par le Ministre Canadian des Communications.

(English translation of the notice above) This digital apparatus does not exceed the Class A limits for radio noise emissions from digital apparatus set out in the interference-causing equipment standard entitled "Digital Apparatus," ICES-003 of the Canadian Department of Communications.

9.6.4 Europe (CE Declaration of Conformity)

This product has been tested in accordance too, and complies with the Low Voltage Directive (73/23/EEC) and EMC Directive (89/336/EEC). The product has been marked with the CE Mark to illustrate its compliance.

9.6.5 Japan EMC Compatibility

Electromagnetic Compatibility Notices (International)

この装置は、情報処理装置等電波障害自主規制協議会（VCCI）の基準に基づくクラスA情報技術装置です。この装置を家庭環境で使用すると電波妨害を引き起こすことがあります。この場合には使用者が適切な対策を講ずるよう要求されることがあります。

English translation of the notice above:

This is a Class A product based on the standard of the Voluntary Control Council For Interference (VCCI) from Information Technology Equipment. If this is used near a radio or television receiver in a domestic environment, it may cause radio interference. Install and use the equipment according to the instruction manual.

9.6.6 BSMI (Taiwan)

The BSMI Certification number and the following warning is located on the product safety label which is located on the bottom side (pedestal orientation) or side (rack mount configuration).

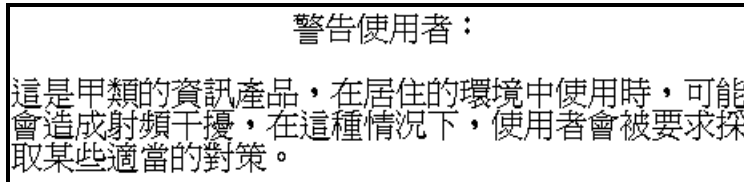

9.6.7 RRL (Korea)

Following is the RRL certification information for Korea.

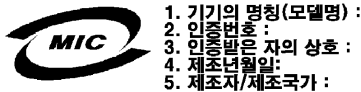









English translation of the notice above:

1. Type of Equipment (Model Name): On License and Product
2. Certification No.: On RRL certificate. Obtain certificate from local Intel representative
3. Name of Certification Recipient: Intel Corporation
4. Date of Manufacturer: Refer to date code on product
5. Manufacturer/Nation: Intel Corporation/Refer to country of origin marked on product

9.7 Product Ecology Compliance

Intel has a system in place to restrict the use of banned substances in accordance with world wide product ecology regulatory requirements. The following is Intel's product ecology compliance criteria.

Compliance Regional Description	Compliance Reference	Compliance Reference Marking Example
California	California Code of Regulations, Title 22, Division 4.5; Chapter 33: Best Management Practices for Perchlorate Materials.	Special handling may apply. See www.dtsc.ca.gov/hazardouswaste/perchlorate This notice is required by California Code of Regulations, Title 22, Division 4.5; Chapter 33: Best Management Practices for Perchlorate Materials. This product/part includes a battery which contains Perchlorate material.
China	China RoHS Administrative Measures on the Control of Pollution Caused by Electronic Information Products" (EIP) #39. Referred to as China RoHS. Mark requires to be applied to retail products only. Mark used is the Environmental Friendly Use Period (EFUP). Number represents years.	
	China Recycling (GB18455-2001) Mark requires to be applied to be retail product only. Marking applied to bulk packaging and single packages. Not applied to internal packaging such as plastics, foams, etc.	
Intel Internal Specification	All materials, parts and subassemblies must not contain restricted materials as defined in Intel's Environmental Product Content Specification of Suppliers and Outsourced Manufacturers – http://supplier.intel.com/ehs/environmental.htm	None Required
Europe	Waste Electrical and Electronic Equipment (WEEE) Directive 2002/96/EC – Mark applied to system level products only.	
	European Directive 2002/95/EC - Restriction of Hazardous Substances (RoHS) Threshold limits and banned substances are noted below. Quantity limit of 0.1% by mass (1000 PPM) for: Lead, Mercury, Hexavalent Chromium, Polybrominated Biphenyls Diphenyl Ethers (PBB/PBDE) Quantity limit of 0.01% by mass (100 PPM) for: Cadmium	None Required
Germany	German Green Dot Applied to Retail Packaging Only for Boxed Boards	

Compliance Regional Description	Compliance Reference	Compliance Reference Marking Example	
Intel Internal Specification	All materials, parts and subassemblies must not contain restricted materials as defined in Intel's Environmental Product Content Specification of Suppliers and Outsourced Manufacturers – http://supplier.intel.com/ehs/environmental.htm	None Required	
International	<p>ISO11469 - Plastic parts weighing >25gm are intended to be marked with per ISO11469.</p> <p>Recycling Markings – Fiberboard (FB) and Cardboard (CB) are marked with international recycling marks. Applied to outer bulk packaging and single package.</p>	>PC/ABS< 	 Corrugated Recycles
Japan	Japan Recycling Applied to Retail Packaging Only for Boxed Boards	 内袋	

9.8 Other Markings

Compliance Description	Compliance Reference	Compliance Reference Marking Example
Stand-by Power	60950 Safety Requirement Applied to product is stand-by power switch is used.	
Multiple Power Cords	60950 Safety Requirement Applied to product if more than one power cord is used.	<p>English: This unit has more than one power supply cord. To reduce the risk of electrical shock, disconnect (2) two power supply cords before servicing.</p> <p>Simplified Chinese: 注意： 本设备包括多条电源系统电缆。为避免遭受电击，在进行维修之前应断开两（2）条电源系统电缆。</p> <p>Traditional Chinese: 注意： 本設備包括多條電源系統電纜。為避免遭受電擊，在進行維修之前應斷開兩（2）條電源系統電纜。</p> <p>German: Dieses Geräte hat mehr als ein Stromkabel. Um eine Gefahr des elektrischen Schlages zu verringern trennen sie beide (2) Stromkabeln bevor Instandhaltung.</p>
Ground Connection	60950 Deviation for Nordic Countries	<p>Line1 :</p> <p>“WARNING: Swedish on line2: “Apparaten skall anslutas till jordat uttag, när den ansluts till ett nätverk.” Finnish on line 3: “Laite on liitettävä suojamaadoituskoskettimilla varustettuun pistorasiaan.” English on line 4: “Connect only to a properly earth grounded outlet.”</p>
Country of Origin	Logistic Requirements Applied to products to indicate where product was made.	Made in XXXX

Appendix A: Integration and Usage Tips

This section provides a list of useful information that should be referenced before attempting to integrate and configure your Intel Server System SR1560SF.

- After the system is integrated with processors, memory, and peripheral devices, the FRUSDR utility **must** be run to load the proper Sensor Data Record data to the integrated Server Management subsystem. Failure to run this utility may prevent Server Management from accurately monitoring system health and may affect system performance. The FRUSDR utility for this server system can either be run from the Intel Deployment CDROM that came with your system, or can be downloaded from the Intel website referenced at the bottom of this page.
- To ensure the highest system reliability, make sure the latest system software is loaded on the server before deploying the system onto a live networking environment. This includes system BIOS, FRUSDR, BMC firmware, and hot-swap controller firmware. The system software can be updated using the Intel Deployment CDROM that came with your system or can be downloaded from the Intel website referenced at the bottom of this page.
- Only supported memory validated by Intel should be used in this server system. A list of supported memory can be found in the Intel® Server System SR1560SF Tested Memory List which can be downloaded from the Intel website referenced at the bottom of this page.
- This system supports the Intel® Xeon® processor 5000 sequence. A list of supported processors is provided in Table 2 of this document, or can be downloaded from the Intel website referenced at the bottom of this page. Intel Xeon processors not referenced on the supported processor list cannot be used in this server system.
- The air dam on the CPU air duct must be in place for single processor configurations. Once the air dam is removed, it cannot be re-installed.
- The CPU air duct and air baffle must be used to maintain system thermals.
- To maintain system thermals, all hard drive bays must be populated with either a hard drive or drive blank.
- System fans are not hot-swappable.
- In systems configured with a backplane, a USB floppy accessory kit is available for installing a slim-line USB floppy drive in either the slim-line bay or in the first 3.5" hard drive bay. This kit has the following Intel product order code: AXXUSBFLOPPY.

Intel Support Website for downloading the latest system documentation, drivers, and system software:

<http://support.intel.com/support/motherboards/server/S5400SF/>

Appendix B: POST Code Diagnostic LED Decoder

During the system boot process, BIOS executes a number of platform configuration processes, each of which is assigned a specific hex POST code number. As each configuration routine is started, BIOS will display the given POST code to the POST Code Diagnostic LEDs found on the back edge of the server board. To assist in troubleshooting a system hang during the POST process, the Diagnostic LEDs can be used to identify the last POST process to be executed.

Each POST code will be represented by a combination of colors from the four LEDs. The LEDs are capable of displaying three colors: green, red, and amber. The POST codes are divided into two nibbles, an upper nibble and a lower nibble. Each bit in the upper nibble is represented by a red LED and each bit in the lower nibble is represented by a green LED. If both bits are set in the upper and lower nibbles then both red and green LEDs are lit, resulting in an amber color. If both bits are clear, then the LED is off.

In the below example, BIOS sends a value of ACh to the diagnostic LED decoder. The LEDs are decoded as follows:

- red bits = 1010b = Ah
- green bits = 1100b = Ch

Since the red bits correspond to the upper nibble and the green bits correspond to the lower nibble, the two are concatenated to be ACh.

Table 46: POST Progress Code LED Example

	8h		4h		2h		1h	
LEDs	Red	Green	Red	Green	Red	Green	Red	Green
ACh	1	1	0	1	1	0	0	0
Result	Amber		Green		Red		Off	
	MSB				LSB			

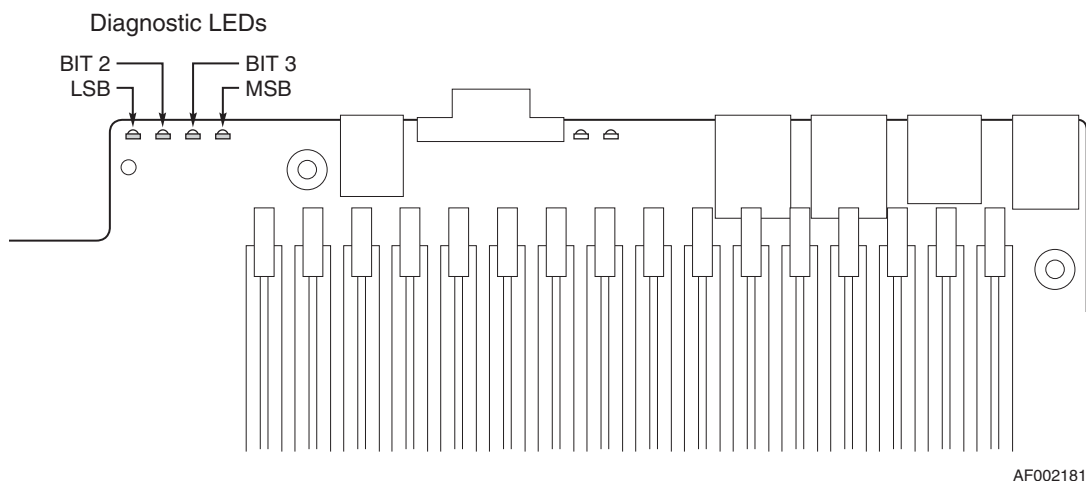

AF002181

Figure 34. Diagnostic LED Placement Diagram

Table 47. Diagnostic LED POST Code Decoder

Checkpoint	Diagnostic LED Decoder				Description
	G=Green, R=Red, A=Amber				
	MSB			LSB	
Host Processor					
0x10h	OFF	OFF	OFF	R	Power-on initialization of the host processor (bootstrap processor)
0x11h	OFF	OFF	OFF	A	Host processor cache initialization (including AP)
0x12h	OFF	OFF	G	R	Starting application processor initialization
0x13h	OFF	OFF	G	A	SMM initialization
Chipset					
0x21h	OFF	OFF	R	G	Initializing a chipset component
Memory					
0x22h	OFF	OFF	A	OFF	Reading configuration data from memory (SPD on DIMM)
0x23h	OFF	OFF	A	G	Detecting presence of memory
0x24h	OFF	G	R	OFF	Programming timing parameters in the memory controller
0x25h	OFF	G	R	G	Configuring memory parameters in the memory controller
0x26h	OFF	G	A	OFF	Optimizing memory controller settings
0x27h	OFF	G	A	G	Initializing memory, such as ECC init
0x28h	G	OFF	R	OFF	Testing memory
PCI Bus					
0x50h	OFF	R	OFF	R	Enumerating PCI busses
0x51h	OFF	R	OFF	A	Allocating resources to PCI busses
0x52h	OFF	R	G	R	Hot Plug PCI controller initialization
0x53h	OFF	R	G	A	Reserved for PCI bus
0x54h	OFF	A	OFF	R	Reserved for PCI bus
0x55h	OFF	A	OFF	A	Reserved for PCI bus
0x56h	OFF	A	G	R	Reserved for PCI bus
0x57h	OFF	A	G	A	Reserved for PCI bus
USB					
0x58h	G	R	OFF	R	Resetting USB bus
0x59h	G	R	OFF	A	Reserved for USB devices
ATA/ATAPI/SATA					
0x5Ah	G	R	G	R	Resetting PATA/SATA bus and all devices
0x5Bh	G	R	G	A	Reserved for ATA
SMBUS					
0x5Ch	G	A	OFF	R	Resetting SMBUS
0x5Dh	G	A	OFF	A	Reserved for SMBUS
Local Console					
0x70h	OFF	R	R	R	Resetting the video controller (VGA)
0x71h	OFF	R	R	A	Disabling the video controller (VGA)
0x72h	OFF	R	A	R	Enabling the video controller (VGA)
Remote Console					
0x78h	G	R	R	R	Resetting the console controller
0x79h	G	R	R	A	Disabling the console controller
0x7Ah	G	R	A	R	Enabling the console controller

Checkpoint	Diagnostic LED Decoder				Description
	G=Green, R=Red, A=Amber				
	MSB			LSB	
Keyboard (PS2 or USB)					
0x90h	R	OFF	OFF	R	Resetting the keyboard
0x91h	R	OFF	OFF	A	Disabling the keyboard
0x92h	R	OFF	G	R	Detecting the presence of the keyboard
0x93h	R	OFF	G	A	Enabling the keyboard
0x94h	R	G	OFF	R	Clearing keyboard input buffer
0x95h	R	G	OFF	A	Instructing keyboard controller to run Self Test (PS2 only)
Mouse (PS2 or USB)					
0x98h	A	OFF	OFF	R	Resetting the mouse
0x99h	A	OFF	OFF	A	Detecting the mouse
0x9Ah	A	OFF	G	R	Detecting the presence of mouse
0x9Bh	A	OFF	G	A	Enabling the mouse
Fixed Media					
0xB0h	R	OFF	R	R	Resetting fixed media device
0xB1h	R	OFF	R	A	Disabling fixed media device
0xB2h	R	OFF	A	R	Detecting presence of a fixed media device (IDE hard drive detection, etc.)
0xB3h	R	OFF	A	A	Enabling/configuring a fixed media device
Removable Media					
0xB8h	A	OFF	R	R	Resetting removable media device
0xB9h	A	OFF	R	A	Disabling removable media device
0xBAh	A	OFF	A	R	Detecting presence of a removable media device (IDE CDROM detection, etc.)
0xBCh	A	G	R	R	Enabling/configuring a removable media device
Boot Device Selection					
0xD0	R	R	OFF	R	Trying boot device selection
0xD1	R	R	OFF	A	Trying boot device selection
0xD2	R	R	G	R	Trying boot device selection
0xD3	R	R	G	A	Trying boot device selection
0xD4	R	A	OFF	R	Trying boot device selection
0xD5	R	A	OFF	A	Trying boot device selection
0xD6	R	A	G	R	Trying boot device selection
0xD7	R	A	G	A	Trying boot device selection
0xD8	A	R	OFF	R	Trying boot device selection
0xD9	A	R	OFF	A	Trying boot device selection
0XDA	A	R	G	R	Trying boot device selection
0xDB	A	R	G	A	Trying boot device selection
0xDC	A	A	OFF	R	Trying boot device selection
0xDE	A	A	G	R	Trying boot device selection
0xDF	A	A	G	A	Trying boot device selection
Pre-EFI Initialization (PEI) Core					
0xE0h	R	R	R	OFF	Started dispatching early initialization modules (PEIM)
0xE2h	R	R	A	OFF	Initial memory found, configured, and installed correctly

Checkpoint	Diagnostic LED Decoder				Description
	G=Green, R=Red, A=Amber				
	MSB			LSB	
0xE1h	R	R	R	G	Reserved for initialization module use (PEIM)
0xE3h	R	R	A	G	Reserved for initialization module use (PEIM)
Driver Execution Environment (DXE) Core					
0xE4h	R	A	R	OFF	Entered EFI driver execution phase (DXE)
0xE5h	R	A	R	G	Started dispatching drivers
0xE6h	R	A	A	OFF	Started connecting drivers
DXE Drivers					
0xE7h	R	A	A	G	Waiting for user input
0xE8h	A	R	R	OFF	Checking password
0xE9h	A	R	R	G	Entering BIOS setup
0xEAh	A	R	A	OFF	Flash Update
0xEEh	A	A	A	OFF	Calling Int 19. One beep unless silent boot is enabled.
0xEFh	A	A	A	G	Unrecoverable boot failure/S3 resume failure
Runtime Phase/EFI Operating System Boot					
0xF4h	R	A	R	R	Entering Sleep state
0xF5h	R	A	R	A	Exiting Sleep state
0xF8h	A	R	R	R	Operating system has requested EFI to close boot services (ExitBootServices () has been called)
0xF9h	A	R	R	A	Operating system has switched to virtual address mode (SetVirtualAddressMap () has been called)
0xFAh	A	R	A	R	Operating system has requested the system to reset (ResetSystem () has been called)
Pre-EFI Initialization Module (PEIM)/Recovery					
0x30h	OFF	OFF	R	R	Crisis recovery has been initiated because of a user request
0x31h	OFF	OFF	R	A	Crisis recovery has been initiated by software (corrupt flash)
0x34h	OFF	G	R	R	Loading crisis recovery capsule
0x35h	OFF	G	R	A	Handing off control to the crisis recovery capsule
0x3Fh	G	G	A	A	Unable to complete crisis recovery.

Appendix C: POST Error Beep Codes

The following table lists POST error beep codes. Prior to system video initialization, BIOS uses these beep codes to inform users on error conditions. The beep code is followed by a user visible code on POST progress LEDs.

Table 48. POST Error Beep Codes

Beeps	Error Message	POST Progress Code	Description
3	Memory error		System halted because a fatal error related to the memory was detected.
6	BIOS rolling back error		The system has detected a corrupted BIOS in the flash part, and is rolling back to the last good BIOS.

The BMC may generate beep codes upon detection of failure conditions. Beep codes are sounded each time the problem is discovered, such as on each power-up attempt, but are not sounded continuously. Codes that are common across all Intel® server boards and systems that use the Intel® S5000 chipset are listed in Table 49. Each digit in the code is represented by a sequence of beeps whose count is equal to the digit.

Table 49. BMC Beep Codes

Code	Reason for Beep	Associated Sensors	Supported?
1-5-2-1	CPU: Empty slot/population error – Processor slot 1 is not populated.	CPU Population Error	Yes
1-5-2-2	CPU: No processors (terminators only)	N/A	No
1-5-2-3	CPU: Configuration error (e.g., VID mismatch)	N/A	No
1-5-2-4	CPU: Configuration error (e.g., BSEL mismatch)	N/A	No
1-5-4-2	Power fault: DC power unexpectedly lost (power good dropout)	Power Unit – power unit failure offset	Yes
1-5-4-3	Chipset control failure	N/A	No
1-5-4-4	Power control fault	Power Unit – soft power control failure offset	Yes

Appendix D: Jumper Block Settings and Usage

The server board has several 2-pin and 3-pin jumper blocks that can be used to configure, protect, or recover specific features of the server board. Pin 1 on each jumper block is denoted by an “*” or “▼”.

Recovery Jumper Blocks

Table 50. Recovery Jumpers

Jumper Name	Pins	What happens at system reset
BMC Force Update	1-2	BMC Firmware Force Update Mode – Disabled (Default)
	2-3	BMC Firmware Force Update Mode – Enabled
Password Clear	1-2	These pins should have a jumper in place for normal system operation. (Default)
	2-3	If these pins are jumpered, administrator and user passwords will be cleared immediately. These pins should not be jumpered for normal operation.
CMOS Clear	1-2	These pins should have a jumper in place for normal system operation. (Default)
	2-3	If these pins are jumpered, the CMOS settings will be cleared immediately. These pins should not be jumpered for normal operation

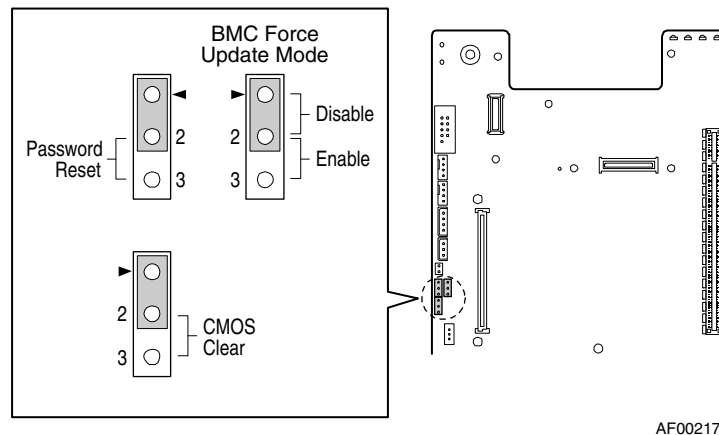

Figure 35. Recovery Jumper Blocks

CMOS Clear and Password Reset Usage Procedure

The CMOS Clear and Password Reset recovery features are designed so that the desired operation can be achieved with minimal system down time. The usage procedure for these two features has changed from previous generation Intel® Server Boards. The following procedure outlines the new usage model.

CMOS Clear Procedure:

1. Power down the server; do not remove AC power.
2. Open the server and move the jumper from the default operating position (pins 1-2) to the “clear” position (pins 2-3).
3. Wait 5 seconds.
4. Move the jumper back to the default position (pins 1-2).
5. Close the server system and power up the server.
6. CMOS is now cleared and can be reset by going into the BIOS setup.

Password Reset Procedure:

1. Power down the server; do not remove AC power.
2. Open the server and move the jumper from the default operating position (pins 1-2) to the “reset” position (pins 2-3).
3. Power up the server.
4. The password is now cleared.
5. Power down the server; do not remove AC power.
6. Move the jumper back to the default position (pins 1-2) and close the server system.
7. The password can be reset by going into the BIOS setup.

Note: Removing AC power before performing the CMOS clear operation will cause the system to automatically power up and immediately power down, after the procedure is followed and AC power is re-applied. Should this occur, remove the AC power cord again, wait 30 seconds, and re-install the AC power cord. Power up system and proceed to the <F2> BIOS Setup Utility to reset desired settings.

BMC Force Update Procedure

When performing a standard BMC firmware update procedure, the update utility places the BMC into an update mode, allowing the firmware to load safely onto the flash device. In the unlikely event that the BMC firmware update process fails due to the BMC not being in the proper update state, the server board provides a BMC Force Update jumper which will force the BMC into the proper update state. The following procedure should be following in the event the standard BMC firmware update process fails.

1. Power down the server and remove AC power.
2. Open the server and move the jumper from the default operating position (pins 1-2) to the “enabled” position (pins 2-3).
3. Close the server system and reconnect AC power and power up the server.
4. Perform the standard BMC firmware update procedure as documented in README.TXT file that is included in the given BMC Firmware Update package.
5. After successful completion of the firmware update process, the firmware update utility may generate an error stating that the BMC is still in update mode.

6. Power down and remove AC power.
7. Open the server and move the jumper from the “enabled” position (pins 2-3) to the “disabled” position (pins 1-2).
8. Close the server system and reconnect AC power and power up the server.

Note: Normal BMC functionality is disabled with the force BMC update jumper set to the “enabled” position. The server should never be run with the BMC force update jumper set in this position and should only be used when the standard firmware update process fails. This jumper should remain in the default – disabled position when the server is running normally.

BIOS Select Jumper

The jumper block at J3H1, located just to the left of the SSI control panel header, is used to select which BIOS image the system will boot to. Pin 1 on the jumper is identified with a ‘▼’. This jumper should only be moved if you wish to force the BIOS to boot to the secondary bank which may hold a different version of BIOS.

The rolling BIOS feature of the baseboard will automatically alternate the Boot BIOS to the secondary bank in the event the BIOS image in the primary bank is corrupted and cannot boot for any reason.

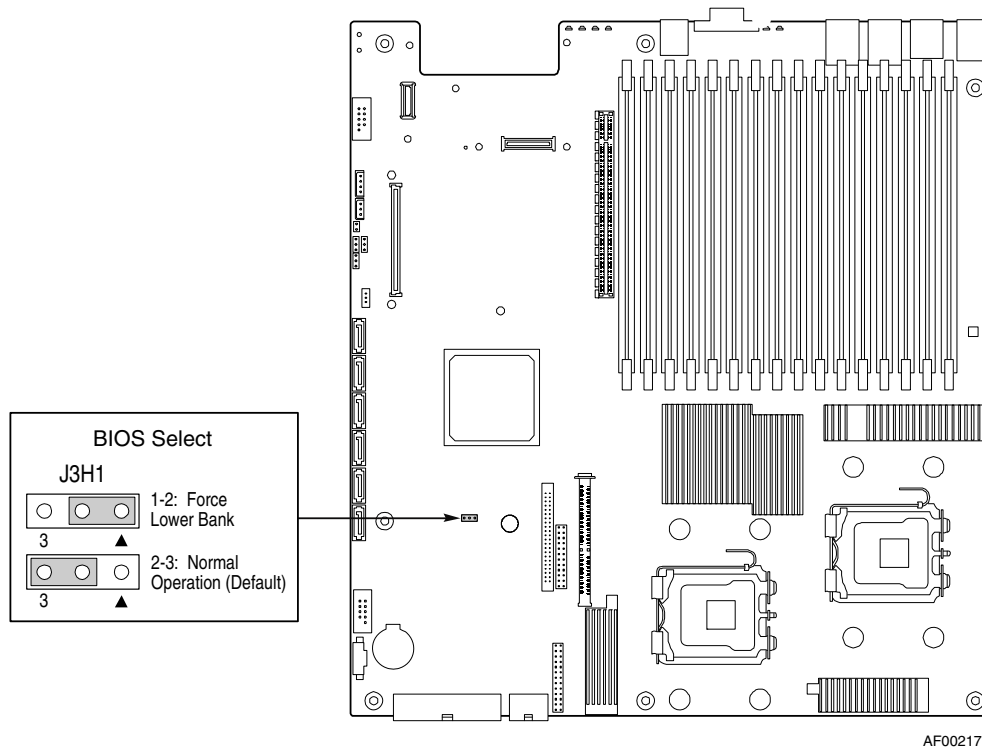

Pins	What happens at system reset...
1-2	Force BIOS to bank 0
2-3	System is configured for normal operation (Default)

Note: When performing a BIOS update procedure, the BIOS select jumper must be set to its default position (pins 2-3).

Figure 36. BIOS Select Jumper (J3H1)

External RJ45 Serial Port Jumper Block

The jumper block J9D1, located directly behind the external RJ45 serial port, is used to configure either a DSR or a DCD signal to the connector.

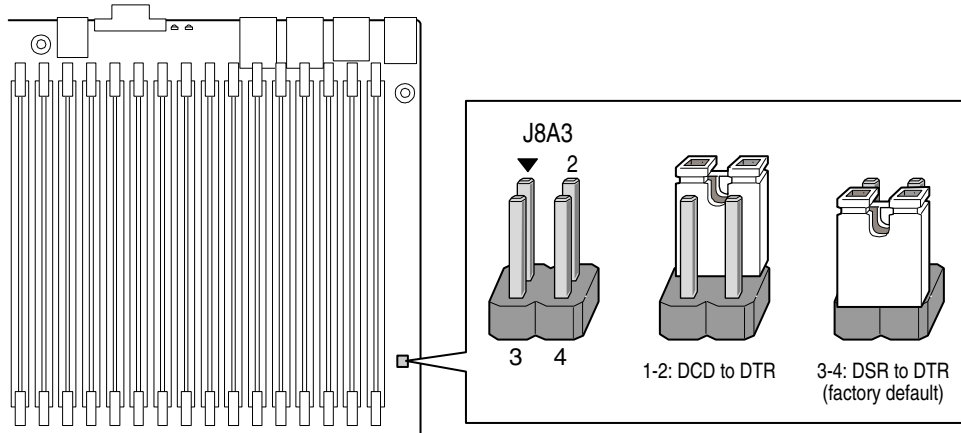

AF002172

Figure 37. External RJ45 Serial Port Configuration Jumper

Glossary

Term	Definition
ACPI	Advanced Configuration and Power Interface
AP	Application Processor
APIC	Advanced Programmable Interrupt Control
ASIC	Application Specific Integrated Circuit
ASMI	Advanced Server Management Interface
BIOS	Basic Input/Output System
BIST	Built-In Self Test
BMC	Baseboard Management Controller
Bridge	Circuitry connecting one computer bus to another, allowing an agent on one to access the other
BSP	Bootstrap Processor
byte	8-bit quantity.
CBC	Chassis Bridge Controller (A microcontroller connected to one or more other CBCs, together they bridge the IPMB buses of multiple chassis.
CEK	Common Enabling Kit
CHAP	Challenge Handshake Authentication Protocol
CMOS	In terms of this specification, this describes the PC-AT compatible region of battery-backed 128 bytes of memory, which normally resides on the server board.
DPC	Direct Platform Control
EEPROM	Electrically Erasable Programmable Read-Only Memory
EHCI	Enhanced Host Controller Interface
EMP	Emergency Management Port
EPS	External Product Specification
ESB2-E	Enterprise South Bridge 2
FBD	Fully Buffered DIMM
FMB	Flexible Mother Board
FRB	Fault Resilient Booting
FRU	Field Replaceable Unit
FSB	Front Side Bus
GB	1024MB
GPIO	General Purpose I/O
GTL	Gunning Transceiver Logic
HSC	Hot-Swap Controller
Hz	Hertz (1 cycle/second)
I2C	Inter-Integrated Circuit Bus
IA	Intel® Architecture
IBF	Input Buffer
ICH	I/O Controller Hub
ICMB	Intelligent Chassis Management Bus
IERR	Internal Error
IFB	I/O and Firmware Bridge
INTR	Interrupt
IP	Internet Protocol
IPMB	Intelligent Platform Management Bus

Term	Definition
IPMI	Intelligent Platform Management Interface
IR	Infrared
ITP	In-Target Probe
KB	1024 bytes
KCS	Keyboard Controller Style
LAN	Local Area Network
LCD	Liquid Crystal Display
LED	Light Emitting Diode
LPC	Low Pin Count
LUN	Logical Unit Number
MAC	Media Access Control
MB	1024KB
MCH	Memory Controller Hub
MD2	Message Digest 2 – Hashing Algorithm
MD5	Message Digest 5 – Hashing Algorithm – Higher Security
ms	milliseconds
MTTR	Memory Type Range Register
Mux	Multiplexor
NIC	Network Interface Controller
NMI	Nonmaskable Interrupt
OBF	Output Buffer
OEM	Original Equipment Manufacturer
Ohm	Unit of electrical resistance
PEF	Platform Event Filtering
PEP	Platform Event Paging
PIA	Platform Information Area (This feature configures the firmware for the platform hardware)
PLD	Programmable Logic Device
PMI	Platform Management Interrupt
POST	Power-On Self Test
PSMI	Power Supply Management Interface
PWM	Pulse-Width Modulation
RAM	Random Access Memory
RASUM	Reliability, Availability, Serviceability, Usability, and Manageability
RISC	Reduced Instruction Set Computing
RMM2	Remote Management Module – 2 nd generation
RMM2 NIC	Remote Management Module – 2 nd generation dedicated management NIC
ROM	Read Only Memory
RTC	Real-Time Clock (Component of ICH peripheral chip on the server board)
SDR	Sensor Data Record
SECC	Single Edge Connector Cartridge
EEPROM	Serial Electrically Erasable Programmable Read-Only Memory
SEL	System Event Log
SIO	Server Input/Output
SMI	Server Management Interrupt (SMI is the highest priority nonmaskable interrupt)
SMM	Server Management Mode

Term	Definition
SMS	Server Management Software
SNMP	Simple Network Management Protocol
TBD	To Be Determined
TIM	Thermal Interface Material
UART	Universal Asynchronous Receiver/Transmitter
UDP	User Datagram Protocol
UHCI	Universal Host Controller Interface
UTC	Universal time coordinate
VID	Voltage Identification
VRD	Voltage Regulator Down
Word	16-bit quantity
ZIF	Zero Insertion Force

Reference Documents

See the following documents for additional information:

- *Intel® Server Board S5400SF Technical Product Specification*
- *Intel® 5400 Series Server Board BIOS External Product Specification*
- *Intel® 5400 Series Server Board Baseboard Management Controller External Product Specification*
- *Intel® 5400 Memory Controller Hub External Design Specification*
- *Intel® Enterprise South Bridge-2 (ESB2-E) External Design Specification*
- *Intel® Remote Management Module 2 Technical Product Specification*
- TEB 2.11 – Thin Electronics Bay (1U/2U Rack Optimized)
- EPS 1U Entry Level Power Supply – 1U non-redundant – Intel® 5400 Chipset Server Board Family
- Design and Evaluation of Snoop Filters for Web Servers (Intel Corporation)