

7 Install DIMM Memory Modules

DDR3 DIMM Memory Identification:

The Intel® Workstation Board S5520SC supports up to 12 DDR3-800/1066/1333 RDIMMs or UDIMMs.

Mixing of RDIMMs and UDIMMs is not supported.

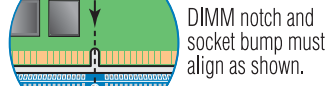
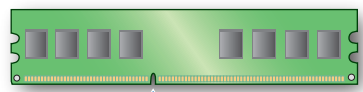

DDR3

Memory Configurations and Population Order:

- Minimum of one 1 GB DDR3-800/1066/1333 RDIMM or UDIMM.
- Install from first slot of each channel (A1, B1, C1, D1, E1, or F1).
- Install Quad-Rank DIMM from first slot of each channel.
- Channel D, E, and F are not available when CPU 2 socket is empty.
- Mixing memory type, size, speed and/or rank on this platform has not been validated and is not supported.
- Mixing memory vendors is not supported on this platform by Intel®.
- Non-ECC memory is not supported and has not been validated in a server environment.

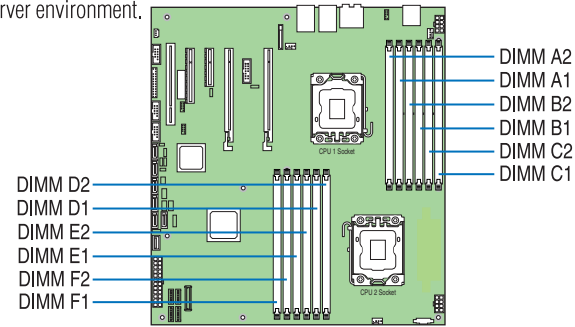

To Install DIMMs:

CAUTION: Avoid touching contacts when handling or installing DIMMs.

- Open both DIMM socket levers.
- Note location of alignment notch.
- Insert DIMM making sure the connector edge of the DIMM aligns correctly with the slot.
- Push down firmly on the DIMM until it snaps into place and both levers close.
- IMPORTANT!** Visually check that each latch is fully closed and correctly engaged with each DIMM edge slot.

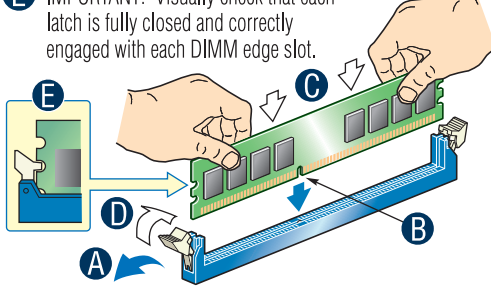

8 Install Heat Sink(s)

Active processor heat sink(s) is required in the Intel® Server Chassis SC5600Base and SC5650WS.

For a non-Intel chassis, see the documentation accompanying your chassis.

CAUTION: The heat sink has thermal interface material (TIM) on the underside of it. Use caution so that you do not damage the thermal interface material. Use gloves to avoid sharp edges. A second heat sink is required for a second processor.

- If a protective film covers the thermal interface material (TIM) on the underside of the heatsink, remove the protective film.
- Align active heat sinks in the Intel® Server Chassis SC5600Base and SC5650WS to let air flow go through to the center of the board.
- Using a #2 Phillips® screwdriver, finger-tighten each fastener diagonally, according to the white-circled numbers.
- Securely re-tighten each fastener again in the same order as performed in Step C.
- Attach active heatsink fan power cable to server board as shown.

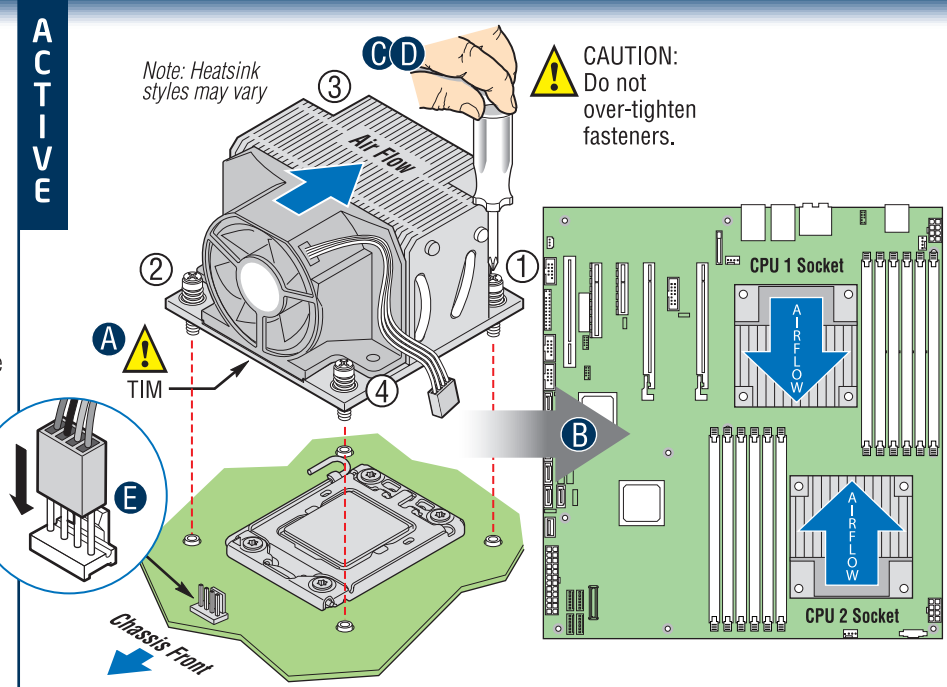

9 Install Optical Drive and Hard Drive(s)

See the documentation that came with your server chassis for drive installation.

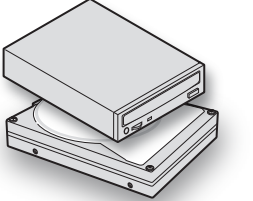

10 Install (Optional) RAID 5 Activation Key/Connect (Optional) SGPIO Cable/Connect Hard Drives/Optical Drive to Workstation Board

- (Optional) Install optional RAID 5 activation key (AXXRKSW5) on on-board RAID 5 key connector as shown.
- (Optional) Connect the SGPIO cable to the workstation board SGPIO connector as shown. Connect the other end of the SGPIO cable to the hot-swap hard disk backplane if installed.
- Connect SATA data cables to the workstation board as shown.

Begin cable connections at the SATA 0 location.

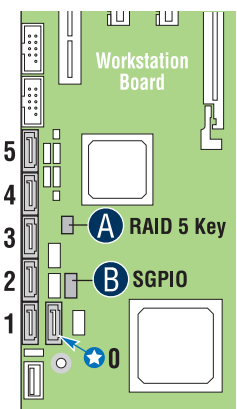

11 (Optional) Install Intel® SAS Entry RAID Module AXX4SASMOD

- Insert the three snap-standoffs into the matching holes in the workstation board.
- Attach the AXX4SASMOD module to the workstation board SAS module connector. Press firmly to engage the snap standoffs.
- (Optional) Connect SES or SGPIO cable to the matching connector on the AXX4SASMOD as shown. Connect the other end of the SES or SGPIO cable to the hot-swap hard disk backplane if installed. DO NOT connect both cables to the AXX4SASMOD SAS module.
- (Optional) Install optional RAID 5 Activation Key (AXXRKSW5) to the AXX4SASMOD SAS module RAID 5 key connector as shown.

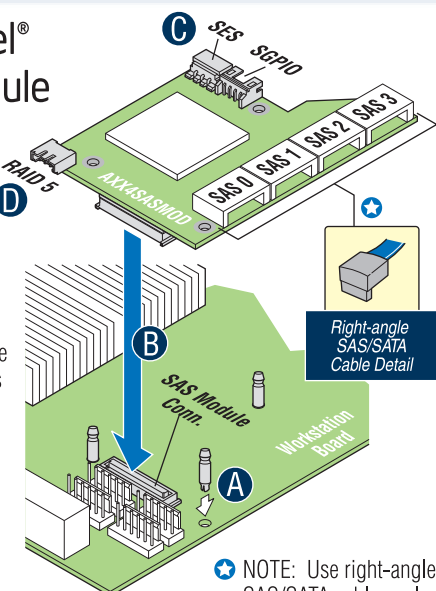

12 Attach Intrusion Switch Cable Accompanying Your Chassis (for Non-Intel Chassis)

Note: For a non-Intel chassis, see your chassis documentation for intrusion switch requirements.

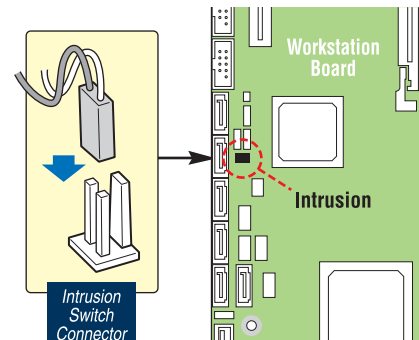

13 Attach Front Panel, Serial, and USB Connections

Note: For a non-Intel chassis, see your chassis documentation for intrusion switch requirements.

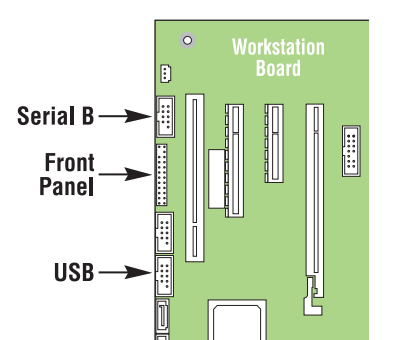

14 (Optional) Install Intel® Remote Management Module 3

- Attach the RMM3 module to the add-in card bracket as shown. Note: The RMM3 installs the same way as an add-in card. See your chassis documentation for add-in card installation procedures.
- Install the RMM3 in an add-in card slot near the workstation board RMM3 header.
- Attach the RMM3 ribbon cable. Make sure each connector end is securely seated.

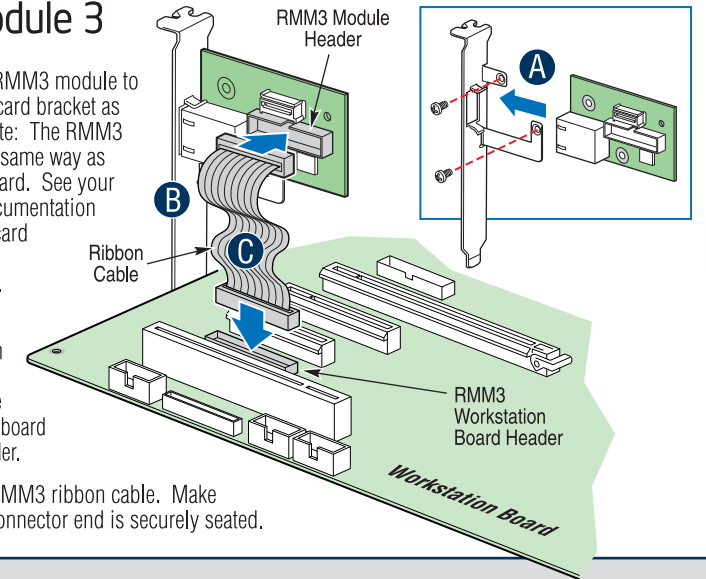

IMPORTANT NOTE: Return to your Intel® Server Chassis Quick Start User's Guide, or your non-Intel chassis documentation to finish installation and configuration of your Intel® Workstation Board S5520SC. Return to this document to finish up, including software, BIOS, drivers and operating system installation.

15 Chassis Fan Connections

See the documentation accompanying your chassis for specific chassis fan connection requirements. For a non-Intel server chassis, see "Making Connections... Quick Reference" below and see the Intel® Workstation Board S5520SC Service Guide.

Attach system fans with 3, 4, or 6-pin connectors here.

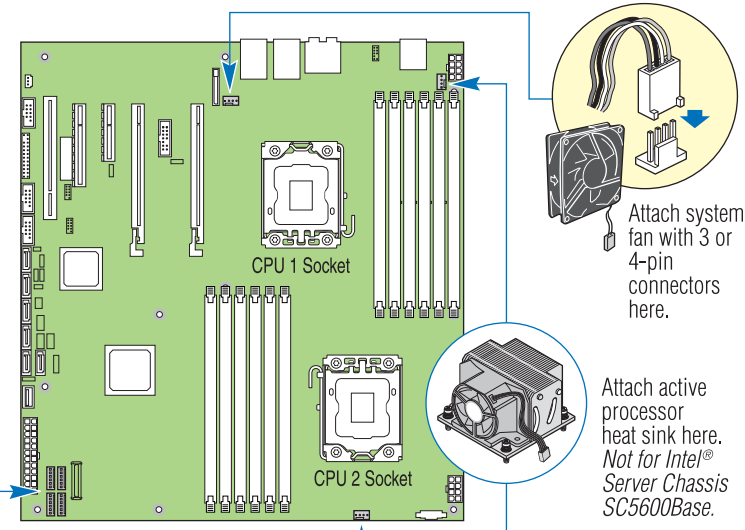
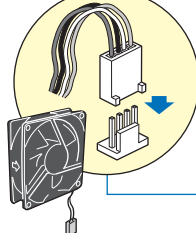

Attach system fan with 3, 4, or 6-pin connectors here.

Attach active processor heat sink here. Not for Intel® Server Chassis SC5600Base.

16 Install Add-in Cards

See the documentation that came with your server chassis for add-in card installation.

For the Intel® Server Chassis SC5600 and the SC5650, see the Quick Start User's Guide accompanying the chassis.

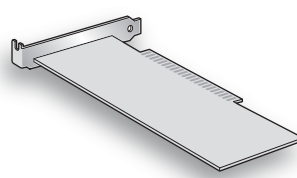

17 Finishing Up

Before installing your operating system, you must finish your chassis installation, make I/O connections and plug in AC power.

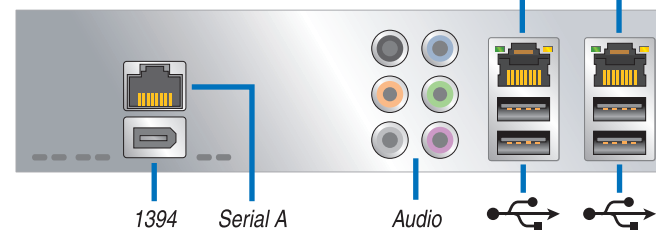

CAUTION: See your chassis documentation for AC power and grounding requirements.

18 Software - BIOS, Firmware, Drivers, and Operating System Installation

- Confirm BIOS Version:** Confirm BIOS, BMC, and FRUSDR Versions. Look on the Server/System Management screen in the BIOS Setup Utility to determine the installed BIOS, BMC firmware, and FRUSDR version. Compare these to the versions at: <http://support.intel.com/support/motherboards/server/S5520SC/>. If new versions are available, see the Intel® Workstation Board S5520SC Week Technical Update to update the BIOS, BMC, and FRUSDR on your server.
- Configure your RAID Controller:** Use the instructions provided with the RAID controller.
- Install your Operating System:** Use the instructions provided with the RAID controller and with the operating system.
- Install Operating System Drivers:** With the operating system running, insert the Intel® Server Deployment Toolkit 3.0 CD, which comes with the production version of the Intel® Workstation Board S5520SC. If using a Microsoft Windows® operating system, the Intel® Deployment Assistant (in the Deployment Toolkit 3.0 CD) will autoun and allow you to select the appropriate drivers to install. On other operating systems, browse the CD folders to locate and install the driver files.

Common Problems and Solutions

For a list of hardware components that have been tested with this system, see: <http://support.intel.com/support/motherboards/server/S5520SC/>

- The system does not boot or show video at power-on:
- Check that all processor power connectors are plugged-in. Without these connections, the server cannot boot.
 - Beep code 3 means you have bad memory; replace the faulty DDR3 DIMM(s).
 - Remember, all DIMMs must be:
 - DDR3 800/1066/1333-compliant, 240-pin DIMMs.
 - No mixing of DDR3 RDIMMs and UDIMMs.
 - Installed beginning with first slot of each channel.
 - Install Quad-Rank DIMM from first slot of each channel.
- The system sometimes works, but is exhibiting erratic behavior.
- This is probably the result of using an underrated power supply.

Making Connections to the Workstation Board Quick Reference

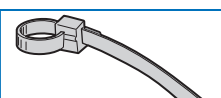

IMPORTANT Note: Cables should be tied for better airflow. Use cable-ties as necessary.

Note: Not all optional connections are shown in this diagram. Refer to the Reference section of this Quick Start User's Guide, your Intel® Workstation Board S5520SC Service Guide, and your server chassis documentation for additional connection information.

Required Connections	Intel® Server Chassis SC5600Base	Intel® Server Chassis SC5650WS
CPU 1 Power Connector	■	■
CPU 2 Power Connector	■	■
Main Power Connector	■	■
Auxiliary Power Connector	■	■
Front Panel Connector	■	■

CPU/System Fan Connections	Intel® Server Chassis SC5600Base	Intel® Server Chassis SC5650WS
CPU Fan 1 Connector	■	■
CPU Fan 2 Connector	■	■
Chassis Fan 1 Connector	■	■
Chassis Fan 2 Connector	■	■
Chassis Fan 3 Connector	■	■
Chassis Fan 4 Connector	■	■
Chassis Fan 5 Connector	■	■

Optional Connections	Intel® Server Chassis SC5600Base	Intel® Server Chassis SC5650WS
HSBP_A	■	■
HSBP_B	■	■
USB_Front Panel	■	■
SATA Connectors	■	■
SATA Software RAID 5 Key	■	■
SAS Module SAS Connectors (optional)	■	■
Serial B	■	■
SATA SGPIO	■	■
SAS Module SES (optional)	■ Either SAS SES or SGPIO	■ Either SAS SES or SGPIO
SAS Module SGPIO (optional)	■ Either SAS SES or SGPIO	■ Either SAS SES or SGPIO
SAS Software RAID 5 Key (optional)	■	■

Note: For a non-Intel chassis, see your chassis documentation for workstation board connection information.

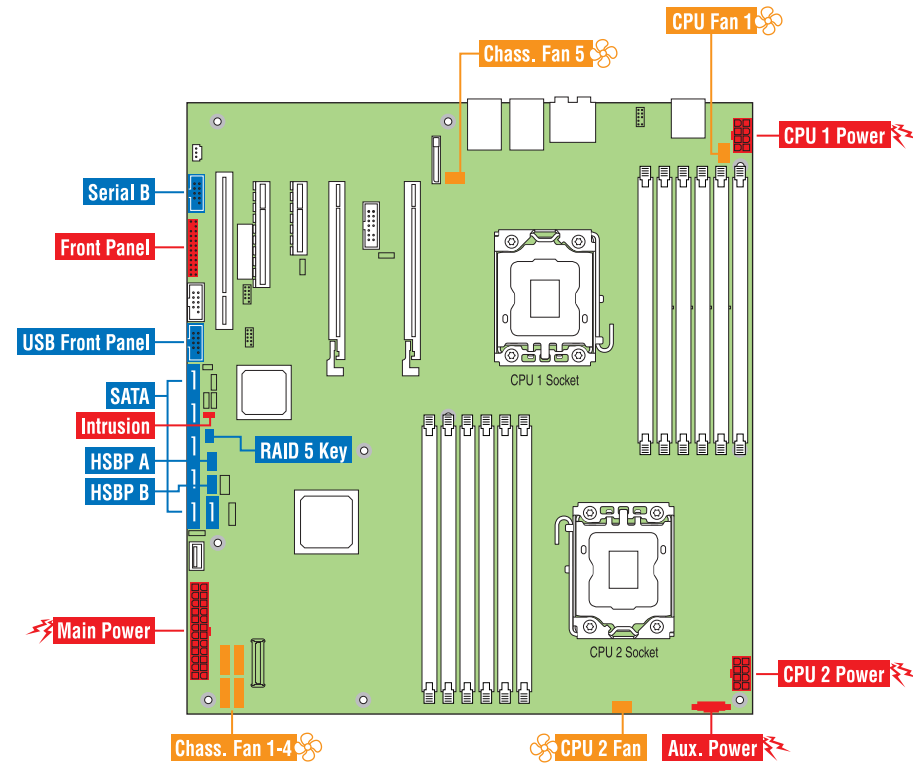

Intel® Workstation Board S5520SC Component Layout

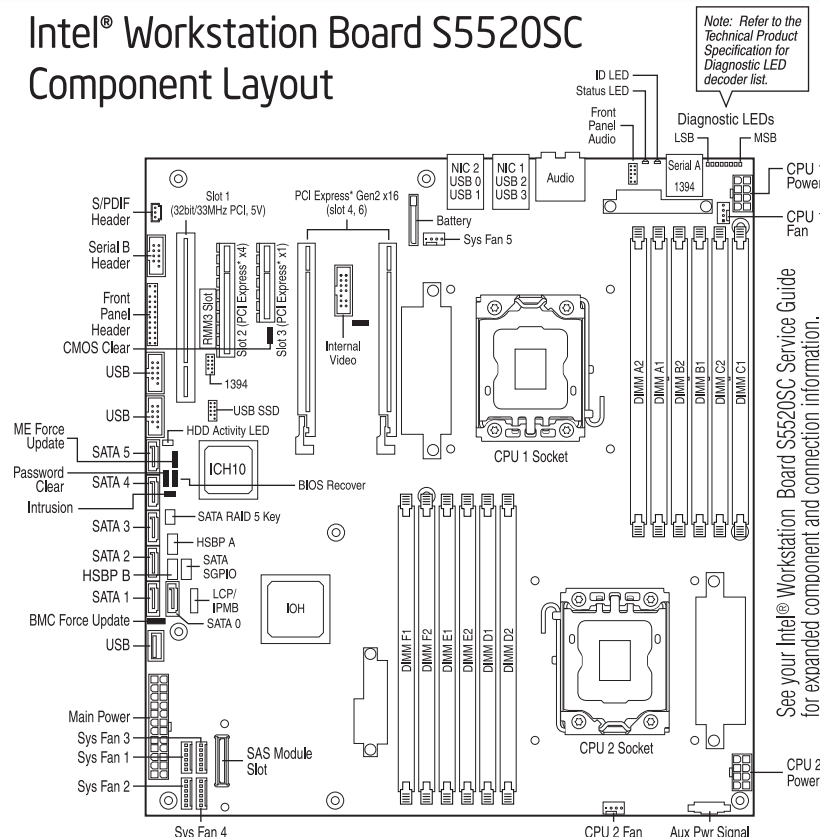

Accessories and Order Codes	
Intel® Remote Management Module 3	AXXRMM3
Intel® SAS Entry RAID Module	AXX4SASMOD
Intel® RAID Activation Key (SATA / SAS Software RAID 5)	AXXRKSW5
Intel® Server Chassis SC5600Base	SC5600Base
Intel® Server Chassis SC5650WS	SC5650WS
Video Cable Kit for Intel® Workstation Board S5520SC on-board Video	FXXSCVDCBL

A complete list of accessories and spares can be found in the Intel® Workstation Board S5520SC Configuration Guide.

Available Documents	
Document Type	Content
Technical Product Specification	In-depth technical information
Spares and Configuration Guide	Supported accessories and spares list
Server Configurator Tool	Tested peripherals and operating systems list Tested memory list Supported processors list
Software and Drivers	Up-to-date firmware, driver and utility information

Additional Reference documents available at: <http://support.intel.com/support/motherboards/server/S5520SC/>