

Intel® Server System SR2612UR Service Guide

**A Guide for Technically Qualified Assemblers of Intel® Identified Subassemblies/
Products**

Intel Order Number E76206-004

Disclaimer

Information in this document is provided in connection with Intel® products. No license, express or implied, by estoppel or otherwise, to any intellectual property rights is granted by this document. Except as provided in Intel's Terms and Conditions of Sale for such products, Intel assumes no liability whatsoever, and Intel disclaims any express or implied warranty, relating to sale and/or use of Intel products including liability or warranties relating to fitness for a particular purpose, merchantability, or infringement of any patent, copyright or other intellectual property right. Intel products are not designed, intended or authorized for use in any medical, life saving, or life sustaining applications or for any other application in which the failure of the Intel product could create a situation where personal injury or death may occur. Intel may make changes to specifications and product descriptions at any time, without notice.

Intel server boards contain a number of high-density VLSI and power delivery components that need adequate airflow for cooling. Intel's own chassis are designed and tested to meet the intended thermal requirements of these components when the fully integrated system is used together. It is the responsibility of the system integrator that chooses not to use Intel developed server building blocks to consult vendor datasheets and operating parameters to determine the amount of airflow required for their specific application and environmental conditions. Intel Corporation can not be held responsible if components fail or the server board does not operate correctly when used outside any of their published operating or non-operating limits.

Intel, Intel Pentium, and Intel Xeon are trademarks or registered trademarks of Intel Corporation or its subsidiaries in the United States and other countries.

* Other names and brands may be claimed as the property of others.

Copyright © 2010, Intel Corporation. All Rights Reserved

Preface

About this Manual

Thank you for purchasing and using the Intel® Server System SR2612UR. This guide assumes you are familiar with Serial ATA (SATA) technology, SAS (Serial Attached SCSI), computer hardware, data storage, and network administration terminology and tasks.

This manual is written for system technicians who are responsible for troubleshooting, upgrading, and repairing this server system. This document provides reference information, feature information, and step-by-step instructions for adding and replacing components in the server system. For the latest version of this manual, see <http://www.intel.com/support/motherboards/server/sr2612ur/>.

Terminology Used in this Guide

Because this guide provides information that you can use to manage one or more storage appliances in a variety of configurations, the generic term “storage system” is used to refer to the controller, disk drives, JBOD expansion enclosures, and servers being used together for data storage.

Many of the terms and concepts referred to in this guide are known to computer users by multiple names. In this guide, this terminology is used:

- Controller (also known as an I/O module or I/O controller)
- Disk drive (also known as hard disk, hard drive, or hard disk drive including Drive Carrier Assembly)
- HBA (also known as Host Bus Adapter, RAID controller/adaptor, or SAS/SATA Adapter)
- Storage Application Array (also known as an Intel® Server System SR2612UR)

Manual Organization

Chapter 1 provides information on the contents of each server system and a list of reference resources. This includes a list of all technical documents that provide additional details on the Intel® Server System SR2612UR, and the location where they can be found.

Chapter 2 describes the features of your Intel® Server System SR2612UR and shows you how you can upgrade your system as your storage requirements change. It also lists the contents of the storage application array package, and describes additional hardware requirements.

Chapter 3 provides instructions for adding and replacing components. It provides step-by-step instructions and diagrams for installing or replacing components such as the fans, power supply, drives, and other components.

Chapter 4 describes the status and activity LEDs that help you monitor the overall status of your Intel® Server System SR2612UR.

Chapter 5 provides instructions on using the utilities that are shipped with the board or that may be required to update the system. This includes information for navigating through the BIOS Setup screens, performing a BIOS update, and resetting the password or BIOS defaults.

The back of this manual provides technical specifications, regulatory information, “getting help” information, and the warranty.

Safety Information

Before you begin the assembly process, you will need to make sure you follow certain basic safety precautions.

Important Safety Instructions

Read all caution and safety statements in this document before performing any of the instructions. See also Intel Server Boards and Server Chassis Safety Information on the *Intel® Server Deployment Toolkit 3.0 CD* and/or at <http://www.intel.com/support/motherboards/server/sb/cs-010770.htm>

Wichtige Sicherheitshinweise

Lesen Sie zunächst sämtliche Warn- und Sicherheitshinweise in diesem Dokument, bevor Sie eine der Anweisungen ausführen. Beachten Sie hierzu auch die Sicherheitshinweise zu Intel-Serverplatinen und Servergehäusen auf der *Intel® Server Deployment Toolkit 3.0 CD* oder unter <http://www.intel.com/support/motherboards/server/sb/cs-010770.htm>

Consignes de sécurité

Lisez attention toutes les consignes de sécurité et les mises en garde indiquées dans ce document avant de suivre toute instruction. Consultez Intel Server Boards and Server Chassis Safety Information sur le *Intel® Server Deployment Toolkit 3.0 CD* ou bien rendez-vous sur le site <http://www.intel.com/support/motherboards/server/sb/cs-010770.htm> Instrucciones de seguridad importantes

Lea todas las declaraciones de seguridad y precaución de este documento antes de realizar cualquiera de las instrucciones. Vea Intel Server Boards and Server Chassis Safety Information en el *Intel® Server Deployment Toolkit 3.0 CD* y/o en <http://www.intel.com/support/motherboards/server/sb/cs-010770.htm>

重要安全指导

在执行任何指令之前，请阅读本文件中的所有注意事项及安全声明。并参阅<http://www.intel.com/support/motherboards/server/sb/cs-010770.htm>上的 *Intel Server Boards and Server Chassis Safety Information*（《Intel 服务器主板与服务器机箱安全信息》）。

Warnings

Heed safety instructions: Before working with your server product, whether you are using this guide or any other resource as a reference, pay close attention to the safety instructions. You must adhere to the assembly instructions in this guide to ensure and maintain compliance with existing product certifications and approvals. Use only the described, regulated components specified in this guide. Use of other products / components will void the UL listing and other regulatory approvals of the product and will most likely result in noncompliance with product regulations in the region(s) in which the product is sold.

System power on/off: The power button DOES NOT turn off the system AC power. To remove power from the system, you must unplug the AC power cord from the wall outlet. Make sure the AC power cord is unplugged before you open the chassis, and add or remove any components.

Hazardous conditions, devices and cables: Hazardous electrical conditions may be present on power, telephone, and communication cables. Turn off the server and disconnect the power cord, telecommunications systems, networks, and modems attached to the server before opening it. Otherwise, personal injury or equipment damage can result.

Electrostatic discharge (ESD) and ESD protection: ESD can damage disk drives, boards, and other parts. We recommend that you perform all the procedures in this chapter only at an ESD workstation. If one is not available, provide some ESD protection by wearing an antistatic wrist strap attached to chassis ground any unpainted metal surface on your server when handling parts.

ESD and handling boards: Always handle boards carefully. They can be extremely sensitive to ESD. Hold boards only by their edges. After removing a board from its protective wrapper or from the server, place the board component side up on a grounded, static free surface. Use a conductive foam pad if available but not the board wrapper. Do not slide board over any surface.

Installing or removing jumpers: A jumper is a small plastic encased conductor that slips over two jumper pins. Some jumpers have a small tab on top that you can grip with your fingertips or with a pair of fine needle nosed pliers. If your jumpers do not have such a tab, take care when using needle nosed pliers to remove or install a jumper; grip the narrow sides of the jumper with the pliers, never the wide sides. Gripping the wide sides can damage the contacts inside the jumper, causing intermittent problems with the function controlled by that jumper. Take care to grip with, but not squeeze, the pliers or other tool you use to remove a jumper, or you may bend or break the pins on the board.

Contents

Preface	iii
About this Manual	iii
Terminology Used in this Guide	iii
Manual Organization	iii
Safety Information	v
Important Safety Instructions	v
Wichtige Sicherheitshinweise	v
Consignes de sécurité	v
Warnings	vi
Chapter 1: Server System Contents and References	1
Server System Contents	1
Intel® Server System SR2612UR Contents	1
Disk Drive Specifications	1
Cable Specifications	1
Appliance Components and Features	2
About the Disk Drives and Drive Carriers	3
Combining SATA and SAS Disk Drives	5
Additional Information and Software	7
Chapter 2: Server System Features	9
Server System Feature Overview	10
Server System Components	12
Intel® Server System SR2612UR Components	14
Intel® Light-Guided Diagnostics	15
Server Board Components	18
Configuration Jumpers	21
Front of Intel® Server System SR2612UR	22
Peripheral Devices	22
Control Panel	24
SAS/SATA Midplanes	26
Active Midplane	26
Hot-Swap SAS/SATA Backplane	27
RAID Support	28
Advanced Management Options	28
Intel® Remote Management Module 3	28
Rack Mount Options	28
Chapter 3: Hardware Installations and Upgrades	29
Before You Begin	29

Tools and Supplies Needed	29
System References	29
Preparing for Installation	29
Installing Your Intel® Server System SR2612UR into a Rack (Optional)	30
Installing the Disk Drives	33
Removing a Disk Drive Carrier Assembly (or Drive Blank)	35
Important Safety Precautions	35
Removing a Disk Drive	35
Installing the Operating System	37
Connecting Your Intel® Server System SR2612UR to a Host Server	38
Connecting to the 1GE iSCSI LAN Data Ports	38
Connecting Additional Enclosures	38
Powering On	38
Installing a 2.5-inch Internal Drive	39
DVD Installation	41
Replacing a Fan	43
Installing a Fan	44
Midplane Board Replacement	45
Memory Installation	46
PCI Card and Battery Installation	48
Power Supply Replacement	51
Replacing the Backplane Board	51
Removing the Backplane Board	52
Installing and Removing the RAID Battery Backup Unit	54
Installing the RAID Battery Backup Unit (BBU)	54
Installing and Removing the Server Board	57
Removing the Server Board	57
Installing the Server Board	60
Replacing the Backup Battery	62
Removing and Installing the Power Distribution Module	63
Removing the Power Distribution Module	63
Installing Power Distribution Module	65
Chapter 4: Server Utilities	69
Using the BIOS Setup Utility	69
Entering BIOS Setup	69
If You Cannot Access Setup	69
Setup Menus	69
Upgrading the BIOS	71
Preparing for the Upgrade	71
Upgrading the BIOS	72
Clearing the Password	72
Restoring the BIOS Defaults	74
Appendix A: Drive Installation in the Drive Carrier	75

Introduction	75
Installing a Disk Drive in a Universal Drive Carrier	75
Installing a Blank Insert in a Universal Drive Carrier	77
Appendix B: Intel® Server Issue Report Form	79
Appendix C: LED Decoder	85
Appliance Status	85
LED Status Board	85
Monitoring the Disk Drives	86
Audible Alarm	87
Appendix D: Getting Help	89
Warranty Information	89
Appendix E: Regulatory and Certification Information	91
Product Regulatory Compliance	91
Product Safety Compliance	91
Product EMC Compliance - Class A Compliance	92
Product Ecology Compliance	93
Certifications / Registrations / Declarations	93
Product Regulatory Compliance Markings	95
Rack Mount Installation Guidelines	99
Power Cord Usage Guidelines	100
Electromagnetic Compatibility Notices	101
FCC Verification Statement (USA)	101
ICES-003 (Canada)	102
CE Declaration of Conformity (Europe)	102
VCCI (Japan)	102
BSMI (Taiwan)	103
KCC (Korea)	103
Regulated Specified Components	103
Appendix F: Installation/Assembly Safety Instructions	105
English	105
Deutsch	107
Français	109
Español	112
Italiano	115
System Specifications	117
G Safety Information	123
English	123
Server Safety Information	123
Safety Warnings and Cautions	123
Intended Application Uses	124
Site Selection	124

Equipment Handling Practices	124
Power and Electrical Warnings	125
Access Warnings	125
Electrostatic Discharge (ESD)	126
Other Hazards	126
Deutsch	127
Sicherheitshinweise für den Server	127
Sicherheitshinweise und Vorsichtsmaßnahmen	127
Zielbenutzer der Anwendung	128
Standortauswahl	128
Handhabung von Geräten	129
Warnungen zu Netzspannung und Elektrizität	130
Warnhinweise für den Systemzugang	130
Elektrostatische Entladungen (ESD)	131
Andere Gefahren	132
Français	133
Consignes de sécurité sur le serveur	133
Sécurité: avertissements et mises en garde	133
Domaines d'utilisation prévus	134
Sélection d'un emplacement	134
Pratiques de manipulation de l'équipement	134
Alimentation et avertissements en matière d'électricité	135
Avertissements sur l'accès au système	135
Décharges électrostatiques (ESD)	136
Autres risques	136
Español	137
Información de seguridad del servidor	137
Advertencias y precauciones sobre seguridad	137
Aplicaciones y usos previstos	138
Selección de la ubicación	138
Manipulación del equipo	139
Advertencias de alimentación y eléctricas	139
Advertencias el acceso al sistema	140
Descarga electrostática (ESD)	141
Otros peligros	141

List of Figures

Figure 1. Intel® Server System SR2612UR Front View	2
Figure 2. Intel® Server System SR2612UR Rear View	3
Figure 3. Intel® Server System SR2612UR Drive Carrier Assembly	4
Figure 4. Intel® Server System SR2612UR Drive Slots	4
Figure 5. Intel® Server System SR2612UR Drive Configurations	5
Figure 6. Unsupported Disk Drive Combinations	6
Figure 7. Intel® Server System SR2612UR	9
Figure 8. Intel® Server System SR2612UR Configuration Diagram	13
Figure 9. Intel® Server System SR2612UR Components	14
Figure 10. Intel® Light-Guided Diagnostic LEDs - Server Board	16
Figure 11. Intel® Light-Guided Diagnostic LEDs - Standard Control Panel	17
Figure 12. System Power LED Back Panel	18
Figure 13. Server Board Connector and Component Locations	20
Figure 14. Configuration Jumpers	22
Figure 15. Optional Peripherals	23
Figure 16. Rear Control Panel	24
Figure 17. Active SAS Midplane Components	26
Figure 18. 3.5-inch Hot-Swap SAS/SATA Backplane Components (Front View)	27
Figure 19. 3.5-inch Hot-Swap SAS/SATA Backplane Components (Rear View)	27
Figure 20. Slider Mechanism	30
Figure 21. Securing the Front and Rear Portions of the Rail Kit	31
Figure 22. Tightening the Screws on the Rail's Slider Mechanism	31
Figure 23. Sliding the Appliance onto the Rails	32
Figure 24. Sliding the Disk Drive into the Drive Slot	33
Figure 25. Pushing the Lever Until It Meets the Latch on Left Side of the Drive Slot	34
Figure 26. Pushing the Button on the Assembly	36
Figure 27. Drive Carrier Unlocked	36
Figure 28. Establishing a Connection to the LAN Data Port	38
Figure 29. Powering-On	39
Figure 30. Removing the drive sled	40
Figure 31. Installing the boot drives	40
Figure 32. Connections Diagram	41
Figure 33. Removing the four screws and cover plate	42
Figure 34. Removing the four screws and cover plate	42
Figure 35. Position the DVD Unit	43
Figure 36. Routing the Cable From the DVD Unit to the Server Board	43
Figure 37. Removing the Defective Fan	44
Figure 38. Midplane	45
Figure 39. Disconnecting the Midplane from the Backplane	46
Figure 40. Memory Slots on the Server Board	47
Figure 41. Installing a DIMM	48
Figure 42. Lifting the PCI Cage Assembly Out of the Enclosure	49

Figure 43. Routing the Cables Through the Fan Assembly	50
Figure 44. Mounting an External Battery	50
Figure 45. Removing the Power Supply	51
Figure 46. Removing the Main Power Connector from the Backplane	52
Figure 47. Removing the Logic Cable Connector from the Backplane	52
Figure 48. Removing the Midplane from the Enclosure	53
Figure 49. Removing the Screws that Attach the Backplane	53
Figure 50. Pulling Back the Backplane and Lifting It Out of the Enclosure	53
Figure 51. Locate the battery	54
Figure 52. Remove the standoff	55
Figure 53. Align the battery pack	55
Figure 54. Aligning the battery pack	56
Figure 55. Replace and tighten standoff	56
Figure 56. Route the cable	56
Figure 57. Connect the cable to PCI RAID Card	57
Figure 58. Disconnect the power cables	58
Figure 59. Disconnect the fan cables	58
Figure 60. Remove the screws	59
Figure 61. Installing the server board	60
Figure 62. Attach the screws	60
Figure 63. Installing power cables	61
Figure 64. Install the fan cables	61
Figure 65. Disconnect the power cables	63
Figure 66. Remove the screws	64
Figure 67. Remove cable chase	64
Figure 68. Remove the four screws from the PDB	65
Figure 69. Installing the Power Distribution Module	65
Figure 70. Route cable P4	66
Figure 71. Install the nylon clamps	66
Figure 72. Connecting cable P4 to backplane	67
Figure 73. Foam orientation	67
Figure 74. Install the power cables	68
Figure 75. Installing a Disk Drive in a Universal Carrier	76
Figure 76. Installing the Four Screws into the Drive Carrier	77
Figure 77. Orienting the Plastic Insert with the Drive Carrier	78
Figure 78. LED Statuses	85
Figure 79. LED Board	86
Figure 80. Disk Drive LEDs	86

List of Tables

Server System References	7
Intel® Server System SR2612UR Feature Summary	10
Setup Menu Key Use	69
LED Decoder	85
LED Board LEDs Descriptions	86
LED Status for the Disk Drive	86
LED Status (SAS/SATA) for the Disk Drive	87
Product Regulatory Compliance Markings	95

1 Server System Contents and References

Server System Contents

The Intel® Server System SR2612UR ships with the Intel® Server Board S5520UR. For information about the server board, see the *Intel® Server Board SR2612UR Technical Product Specification*.

The contents of the Intel® Server System SR2612UR are listed in the following section.

Intel® Server System SR2612UR Contents

Your Intel® Server System SR2612UR ships with the following items:

- Storage Application Array
- Adjustable rackmount kit
- Two plastic rack ear covers
- Product CD
- Attention Doc

Disk Drive Specifications

The Intel® Server System SR2612UR supports up to 12 SAS and/or SATA disk drives.

Disk drives and two optional 2.5-inch fixed 3 Gbps SATA hard drives must meet these specifications and must be qualified for Intel® Server System SR2612UR:

- 7200, 10,000, or 15,000 rpm
- Hot-swap/hot-plug support
- SATA or SAS device plug connector
- 3 Gb/sec (or 300 MB/sec) data rate for SAS and SATA, 1.5 Gb/sec data rate for SATA
- 3.5-inch form factor, 1-inch high

Cable Specifications

To connect your Intel® Server System SR2612UR to a host using the dual integrated 1GE iSCSI ports, use high-quality Cat5e ethernet cables that meet these length requirements:

- Minimum length: 0.5 m
- Maximum length: 10 m

For updated disk drive information or to purchase qualified disk drives or SAS cables, contact your Intel sales representative.

Appliance Components and Features

The main features of the appliance are shown in the following figures.

System Front View



Figure 1. Intel® Server System SR2612UR Front View

System Rear View

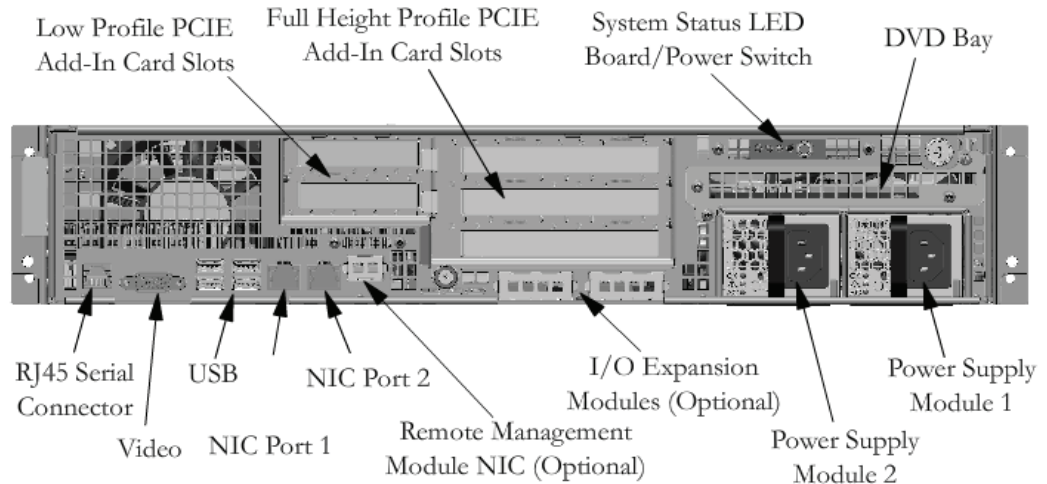

Figure 2. Intel® Server System SR2612UR Rear View

Note: The SAS expansion port is either part of the PCI RAID adapter card or is a separate multi-port PCI SAS card. Currently, the qualified and supported PCI RAID card are Intel® RAID Controller SRCASJV, Intel® RAID Controller SRCASLS4I and Intel® RAID Controller SASWT4I. Please refer to the Intel Customer Support web site under the link for these RAID controllers at: <http://www.intel.com/support/motherboards/server/>

About the Disk Drives and Drive Carriers

The Intel® Server System SR2612UR supports up to 12 SAS and/or SATA disk drives. SAS and SATA disk drives are not supported within the same appliance enclosure; however, only in specific configurations (as shown later in this chapter).

Each disk drive is mounted on a drive carrier assembly (shown in the following figure) with a push-button lever for quick installation and removal.

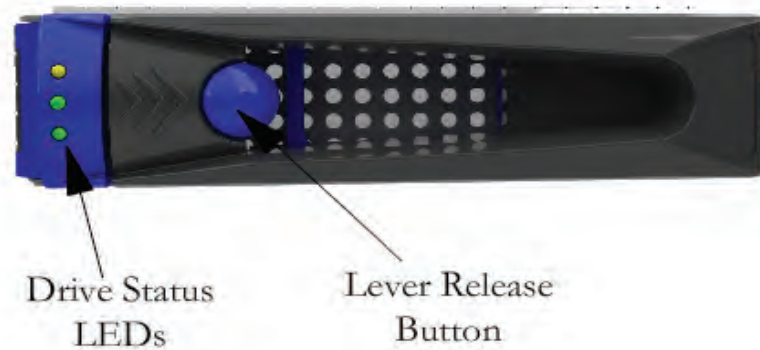

Figure 3. Intel® Server System SR2612UR Drive Carrier Assembly

Each drive carrier has three LEDs, which indicate status as described in “[Monitoring the Disk Drives](#)”.

To maintain proper airflow and cooling inside the appliance, all drive slots must have either a disk drive carrier assembly populated with an actual disk or a special plastic drive blank installed. Under no circumstances should the appliance be operated with empty drive slots or with empty drive carrier assemblies as this could cause damage to the LEDs on the midplane and/or create thermal problems (as well as void the Limited Warranty).

Disk drives are hot-swappable.

Drive Slot Numbers



Figure 4. Intel® Server System SR2612UR Drive Slots

Warning: *Disk drives spin at high speed. When removing a Disk Drive Carrier from an enclosure with power on, unlatch the carrier and allow the drive to completely spin down for approximately 15-20 seconds before sliding the carrier out of the enclosure. Removing the Disk Drive Carrier assembly while the drive is spinning could cause injury and may cause severe damage to the disk drive.*

Combining SATA and SAS Disk Drives

If you are combining SAS and SATA disk drives in the same enclosure, use the following figures to plan where you will place the disk drives.

These figures represent enclosures fully-loaded with disk drives. However, the same guidelines apply even if you are filling some of the drive slots with blank drive carriers.

Recommended Disk Drive Configurations

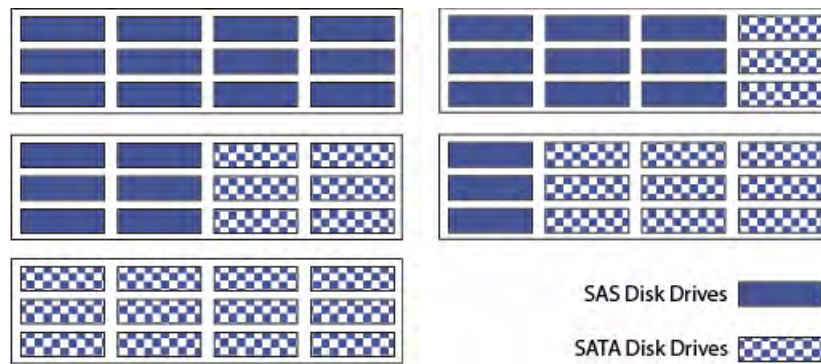

Figure 5. Intel® Server System SR2612UR Drive Configurations

Unsupported Disk Drive Combinations

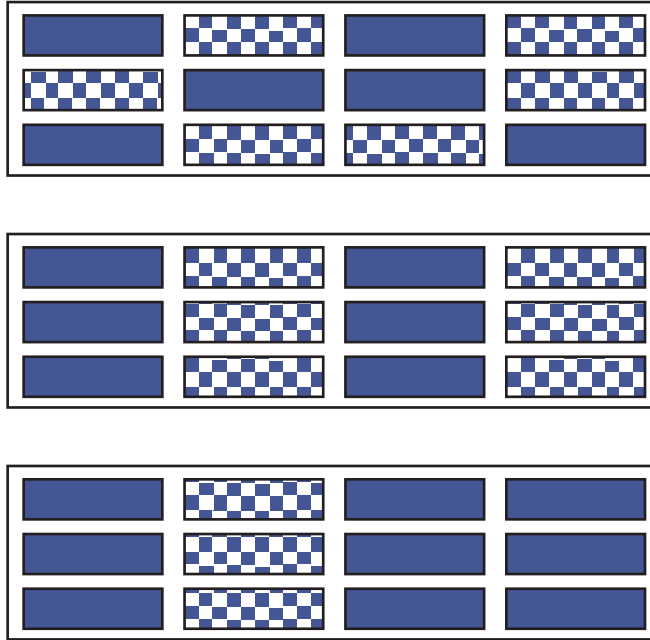

Figure 6. Unsupported Disk Drive Combinations

Additional Information and Software

If you need more information about these products or information about the accessories that can be used with these server systems, use the following resources.

Table 1. Server System References

For this information or software	Use this Document or Software
For in-depth technical information about the server system, including subsystem overviews and mechanical drawings	Intel® Server System SR2612UR Technical Product Specification Available at: http://www.intel.com/support/motherboards/server/sr2612ur/
For in-depth technical information about the server board, including board layout, connector pin-outs, timing information, mechanical drawings and LED information	Intel® Server Board S5520UR Technical Product Specification Available at: http://support.intel.com/support/server_boards/server/s5520ur/
For basic BIOS settings and chipset information	Intel® Server Board S2612UR Technical Product Specification Available at: http://www.intel.com/support/motherboards/server/sr2612ur/
If you just received this product and you need to assemble your system and install components	Intel® Server System SR2612UR Quick Start User's Guide Provided in the product box
Accessories or other Intel server products	Spares, Parts List and Configuration Guide Available at: http://www.intel.com/support/motherboards/server/sr2612ur/ or by using the Server Configurator Tool Available at: http://serverconfigurator.intel.com/default.aspx
Hardware (peripheral boards, adapter cards) and operating systems that were tested with this product Processors that were tested with this product DIMMs that were tested with this product Hard Drives that were tested with this product	Server Configurator Tool Available at: http://serverconfigurator.intel.com/default.aspx

Table 1. Server System References

For this information or software	Use this Document or Software
Latest drivers, firmware updates (BIOS, BMC, and FRUSDR), and utilities	Available for download at: http://www.intel.com/support/motherboards/server/sr2612ur/ Click the "Software and Drivers" link on the left side of the web page.
To make sure your system falls within the allowed power budget	Power Budget Analysis Tool Available at: http://www.intel.com/support/motherboards/server/sr2612ur/
For software to manage your Intel® server	Intel® System Management Software Available at: http://www.intel.com/go/servermanagement/

2 Server System Features

This chapter briefly describes the main features of the Intel® Server System SR2612UR. This includes illustrations of the products, a list of the server system features, and diagrams showing the location of important components and connections on the server systems.

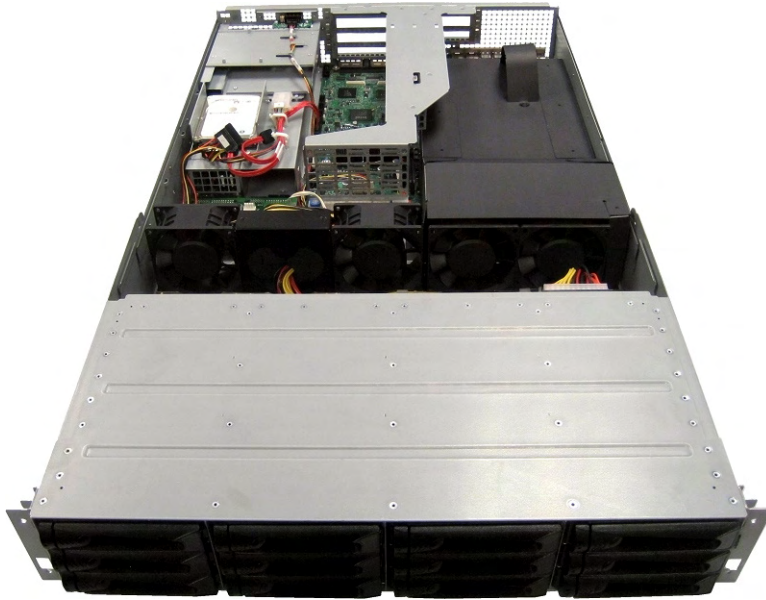

Figure 7. Intel® Server System SR2612UR

Server System Feature Overview

Table 2 summarizes the features of the server systems.

Table 2. Intel® Server System SR2612UR Feature Summary

Feature	Description
Dimensions	<ul style="list-style-type: none"> • 3.43 inches (87 mm) high • 17.57 inches (446 mm) wide • Rack Mounting Surface to Rear I/O Tray Module Handle <ul style="list-style-type: none"> – 30.79 inches (781.5 mm) deep • Front Surface of Disk Drive to Rear I/O Tray Module <ul style="list-style-type: none"> – 32.01 inches (812.4 mm) deep • 67 pounds (30.3 kg) - maximum chassis weight
Server Board	Intel® Server Board S5520UR
Processor	<p>Support for one or two Intel® Xeon® Processor 5500 Series with a 4.8 GT/s, 5.86 GT/s, or 6.4 GT/s Intel® QPI link interface.</p> <p>Support up to 95-W Thermal Design Power (TDP); processors having higher TDP are not supported.</p> <p>This server board does not support previous generations of the Intel® Xeon® processors.</p> <p>For a complete updated list of supported processors, see http://www.intel.com/support/motherboards/server/sr2612ur/.</p> <p>On the Support tab, look for Compatibility and then Supported Processor List.</p>
Memory	<p>Support for 800/1066/1333 MT/s ECC registered (RDIMM) or unbuffered DIMM (UDIMM) DDR3 memory</p> <ul style="list-style-type: none"> • 12 DIMMs across six memory channels (three channels per processor)
Chipset	<ul style="list-style-type: none"> • Intel® 5520 chipset I/O Hub • Intel® 82801Jx I/O Controller Hub

Table 2. Intel® Server System SR2612UR Feature Summary

Feature	Description
Peripheral Interfaces	<p>External connections:</p> <ul style="list-style-type: none"> • Four USB 2.0 connectors (back) • RJ-45 serial Port A connector • Two RJ-45 10/100/1000 Mb Network connections • DB-15 video connector (front and back) <p>Internal connections:</p> <ul style="list-style-type: none"> • One USB 2x5 pin header, which supports two USB 2.0 ports • One low-profile USB 2x5 pin header to support low-profile USB solid state drives • One DH-10 serial Port B header • Six Serial ATA II connectors • Two I/O module connectors • One RMM3 connector to support an optional Intel® Remote Management Module 3 • SATA Software RAID 5 Activation Key connector • One SSI-EEB-compliant front panel header • One SSI-EEB-compliant 24-pin main power connector • One SSI-compliant 8-pin CPU power connectors • One SSI-compliant power supply SMBus connector
Video	<p>On-board Server Engines* LLC Pilot II controller with:</p> <ul style="list-style-type: none"> • Integrated 2D Video Controller • 32 MB DDR2 Memory
LAN	Two 10/100/1000 ports provided by Intel® 82575 PHYs
Expansion Capabilities	<p>The following riser card options are available:</p> <ul style="list-style-type: none"> • Three full-height PCI Express* slots (passive) • Five full-height PCI Express* slots (active)
Hard Drives	<ul style="list-style-type: none"> • Intel® Server System SR2612UR: • 12 3.5-inch hot-swap SATA / SAS hard drives • Two optional 2.5-inch fixed 3Gbps SATA hard drives (inside chassis). • Intel® Embedded Server RAID Technology II with SW RAID levels 0/1/10 • Optional support for SW RAID 5 with activation key
Peripherals	<ul style="list-style-type: none"> • Slimline bay for slimline SATA optical drive (back) • PCI riser card bracket
Control Panel	<ul style="list-style-type: none"> • Standard control panel provides: <ul style="list-style-type: none"> – LEDs (front and back) – Power switch (back)

Table 2. Intel® Server System SR2612UR Feature Summary

Feature	Description
LEDs and displays	<ul style="list-style-type: none"> • Power LED • Standby Power LED (+3.3V Standby) • System Status • System Identification • Enclosure Subsystem Fault • Hard Drive Activity • Hard Drive Status Intel® Light-Guided diagnostics: <ul style="list-style-type: none"> – Fan Fault – DIMM Fault – CPU Fault – 5V-Standby – System Status – System Identification <ul style="list-style-type: none"> • POST Code Diagnostics
Power Supply	Up to two 760-W power supply modules
Fans	<ul style="list-style-type: none"> • Non-redundant fan option containing four system fans • Non-redundant fan in each power supply module
System Management	On-board ServerEngines* LLC Pilot II Controller <ul style="list-style-type: none"> • Integrated Baseboard Management Controller (Integrated BMC), IPMI 2.0 compliant • §Integrated Super I/O on LPC interface Support for Intel® System Management Software 3.1

Server System Components

This section helps you identify the components of your server system. If you are near the system, you can also use the Quick Reference Label provided on the inside of the chassis cover to assist in identifying components.

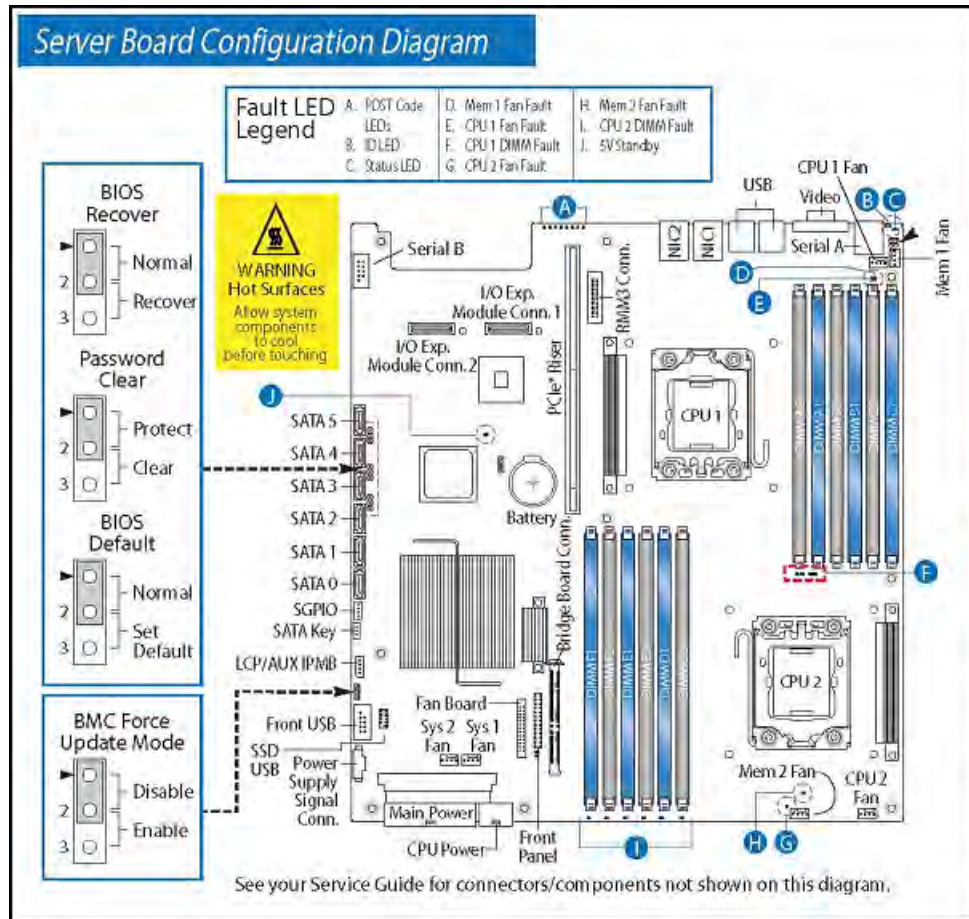
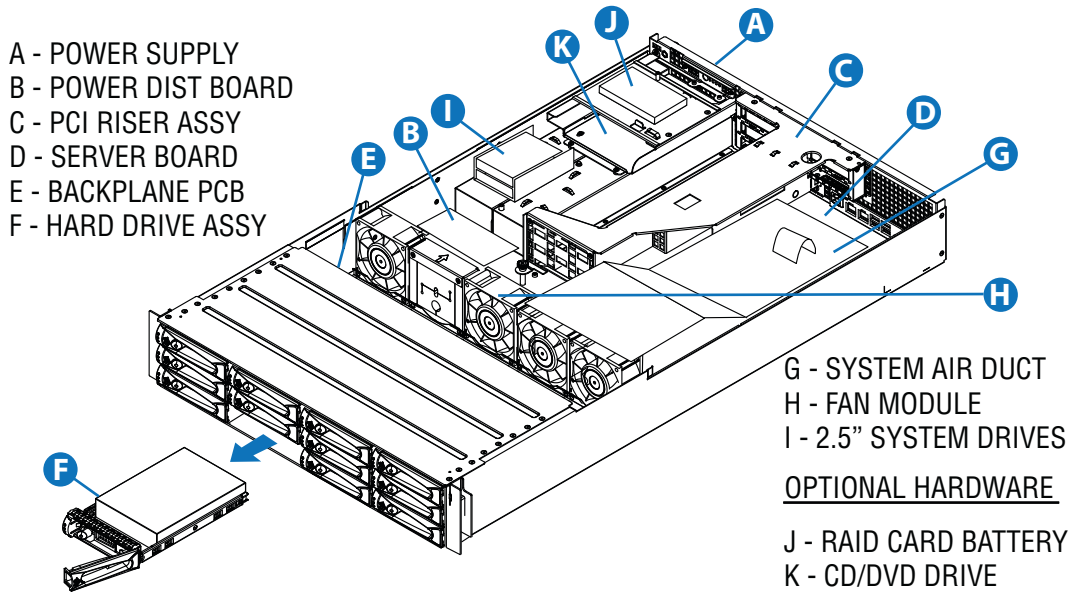

Figure 8. Intel® Server System SR2612UR Configuration Diagram

Intel® Server System SR2612UR Components



A. Power Supply	G. System Air Duct
B. Power Distribution Board	H. Fan Module
C. PCI Riser Assembly	I. 2.5-inch System Drives
D. Server Board	J. RAID Card Battery (Optional)
E. Backplane PCB	K. CD/DVD Drive (Optional)
F. Hard Drive Assembly	

Figure 9. Intel® Server System SR2612UR Components

Intel® Light-Guided Diagnostics

The server system contains the following diagnostic LEDs, each providing the following functions:

- The System Power LED on the front and back panels (see [Figure 11](#) and [Figure 12](#)) shows the system power supplies status (off, green).
- The Enclosure Services Subsystem fault LED on the front and back panels (See [Figure 11](#) and [Figure 12](#)) shows health of the enclosure service subsystem (off, amber).
- The System Status LED on the front and back panels (see [Figure 11](#) and [Figure 12](#)) shows the overall health of the system (green, blinking green, blinking amber, amber, off).
- The System Identification LED on the front and back panel (see [Figure 11](#) and [Figure 12](#)) helps identify the server from among several servers. The ID LED is off by default, and blue when activated by button or software.

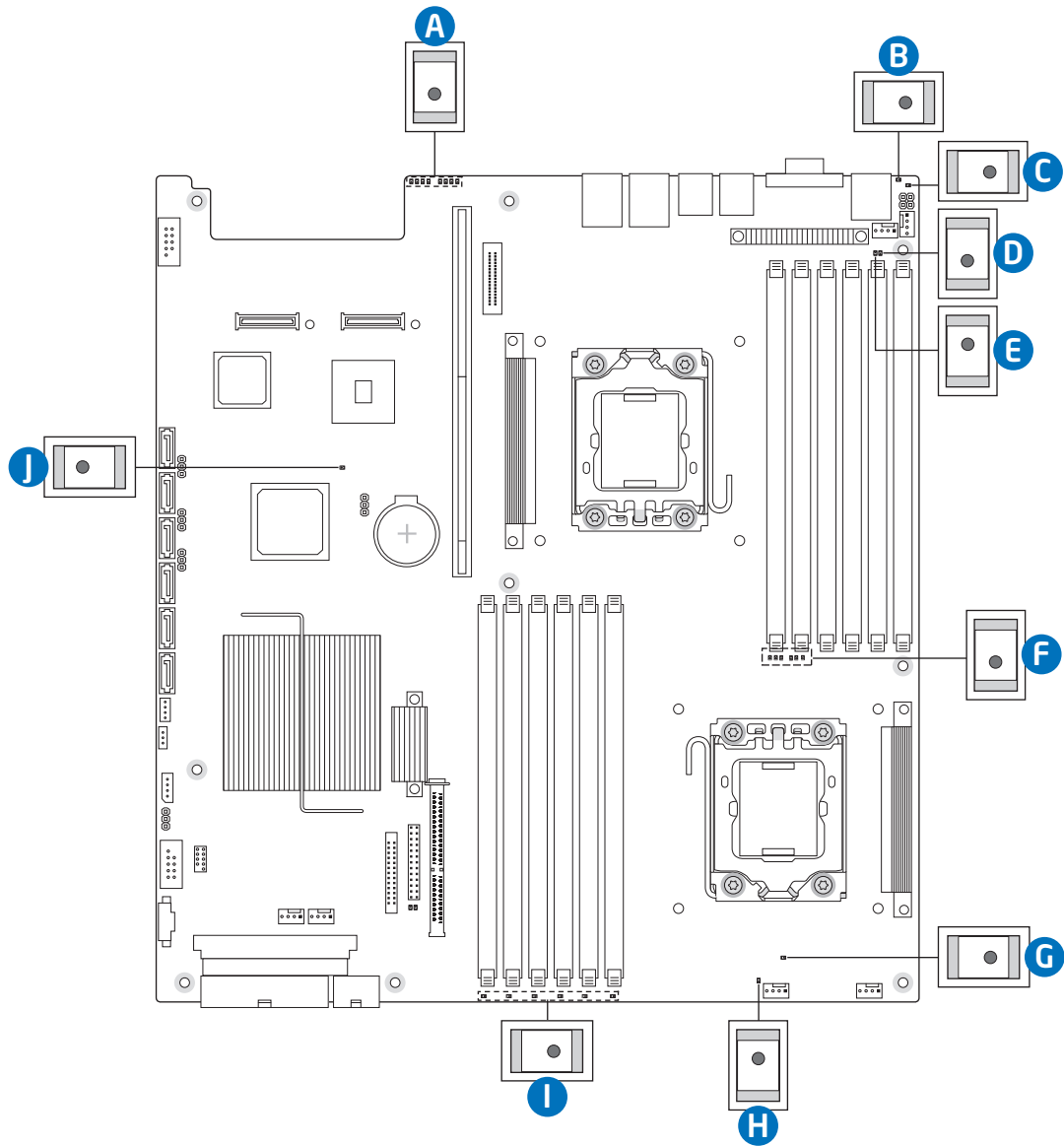

AF002B33

A. POST Code Diagnostic LEDs	B. System Identification LED
C. Status LED	D. Memory 1 Fan Fault LED
E. CPU 1 Fan Fault LED	F. CPU 1 DIMM Fault LEDs
G. CPU 2 Fan Fault LED	H. Memory 2 Fan Fault LED
I. CPU 2 DIMM Fault LEDs	J. 5V Standby LED

Figure 10. Intel® Light-Guided Diagnostic LEDs - Server Board

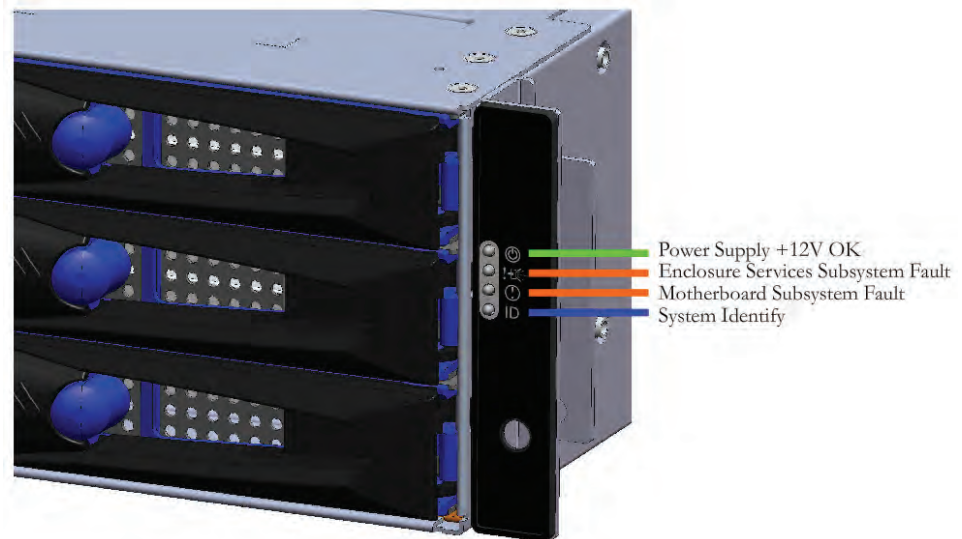
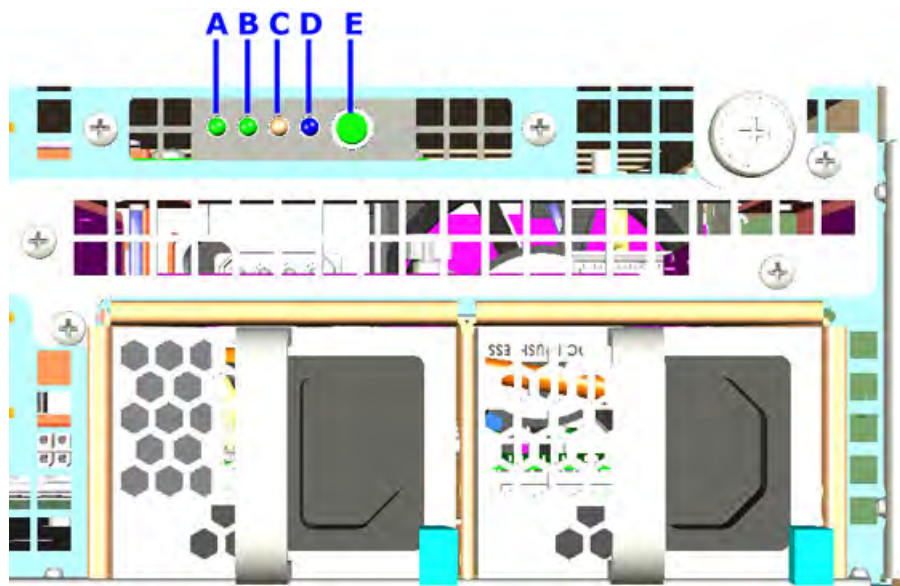

Figure 11. Intel® Light-Guided Diagnostic LEDs - Standard Control Panel



Item	Function	Color	State	Description
A.	Standby Power OK LED (+3.3V)	Green	Off	AC Power Off
			On	AC power on or DC power on
B.	System Status LED	Green	Solid On	System booted and ready
			Blink	Degraded
C.	System Status LED	Amber	Blink	Non-critical
			Solid On	Critical, non-recoverable
D.	System Identification LED	Blue	On	Identify active through command
			Off	No Identification
E.	Power Switch	N/A	N/A	N/A

Figure 12. System Power LED Back Panel

Server Board Components

This section helps you identify the components and connectors on the server board.

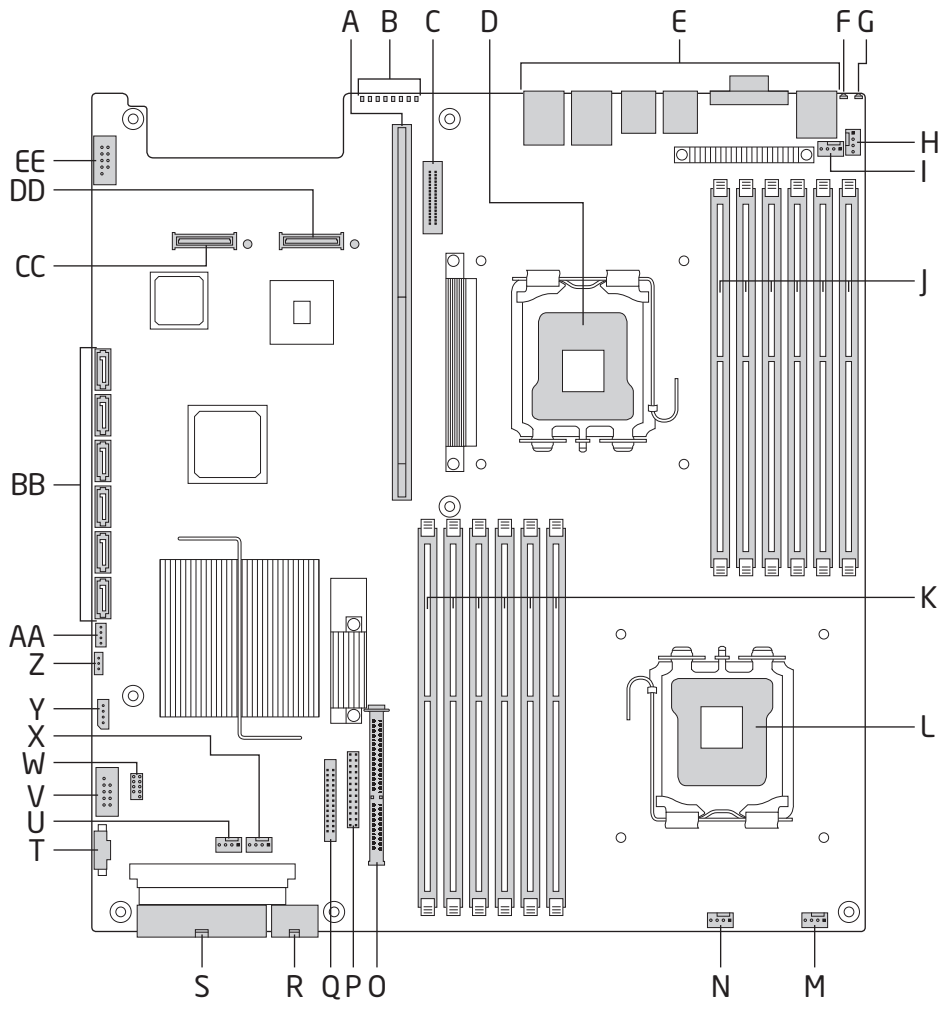

AF002696

A. 280-pin Intel® Adaptive Slot	B. POST Code Diagnostic LEDs	C. Intel® RMM3 Header
D. Processor 1 Socket	E. Back Panel I/O Ports	F. System Identification LED
G. System Status LED	H. Memory 1 Fan Header	I. CPU 1 Fan Header
J. Processor 1 DIMM slots	K. Processor 2 DIMM slots	L. Processor 2 Socket
M. CPU 2 Fan Header	N. Memory 2 Fan Header	O. Bridge Board Connector (Intel® Server Chassis)
P. Front Panel Connector	Q. Fan Board Connector	R. 2x4 Power Connector
S. Main Power Connector	T. Power Supply SMBus Connector	U. System 2 Fan Header
V. USB Header	W. Low-profile USB Solid State Drive Header	X. System 1 Fan Header
Y. LCP IPMB Header	Z. SATA RAID 5 Key Header	AA. SGPIO Header
BB. SATA Connectors	CC. I/O Module Mezzanine Connector 2	DD. I/O Module Mezzanine Connector 1
EE. Serial Port B Header		

Figure 13. Server Board Connector and Component Locations

Configuration Jumpers

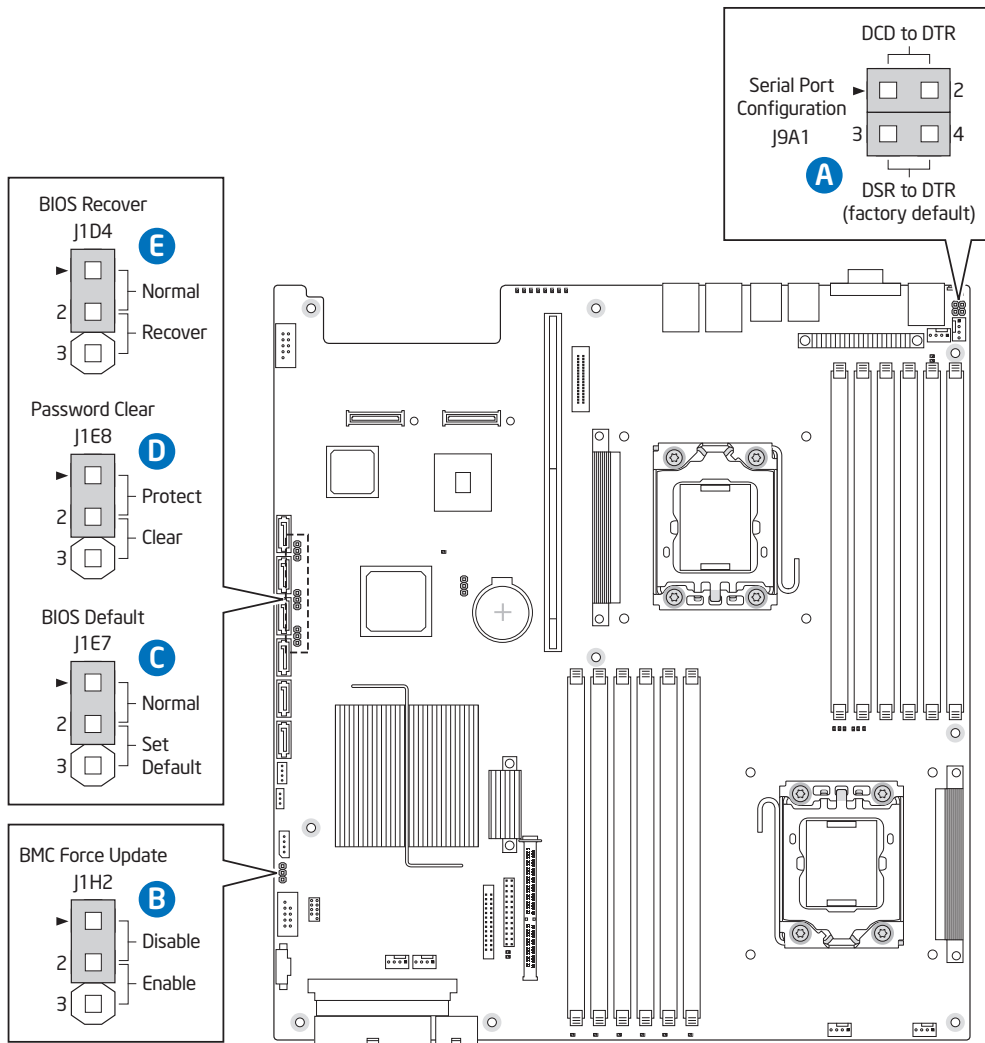

AF002832

	Jumper Name	Jumper Purpose
A.	Serial Port Configuration (J9A1)	If pins 1-2 are jumpered, the DCD to DTR mode is enabled. These pins should be jumpered on 3-4 to operate in the DSR to DTR (default) mode.
B.	BMC Force Update (J1H2)	If pins 2-3 are jumpered, the Integrated BMC Force Update Mode is enabled. These pins should be jumpered on 1-2 for normal system operation.
C.	BIOS Default (J1E7)	If pins 2-3 are jumpered, the BIOS settings are cleared on the next reset. These pins should be jumpered on 1-2 for normal operation.
D.	Password Clear (J1E8)	If pins 2-3 are jumpered, administrator and user passwords are cleared within five to ten seconds after the system is powered on. These pins should be jumpered on 1-2 for normal system operation.

	Jumper Name	Jumper Purpose
E.	BIOS Recover (J1D4)	If pins 2-3 are jumpered, the system can only boot from EFI-bootable recovery media with the recovery BIOS image. The main system BIOS will not boot. These pins should be jumpered on 1-2 for normal system operation.

Figure 14. Configuration Jumpers

Front of Intel® Server System SR2612UR

Peripheral Devices

The Intel® Server System SR2612UR provides locations and hardware for installing hard drives, CD-ROM drive, or DVD-ROM drive. The drives must be purchased separately. The following figure shows the available options.

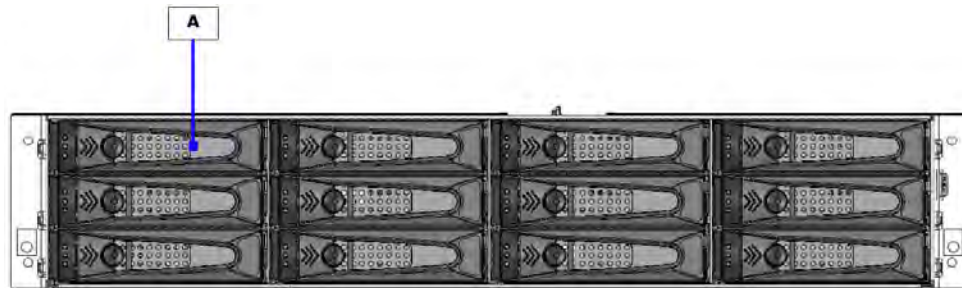

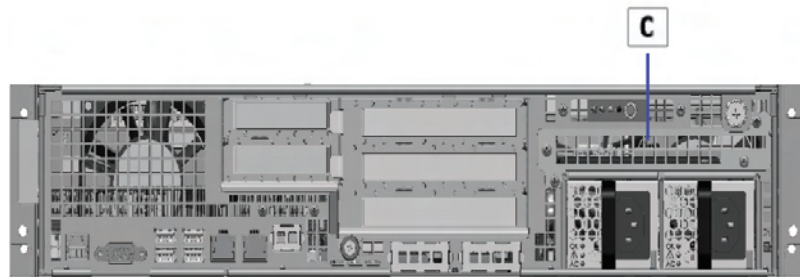
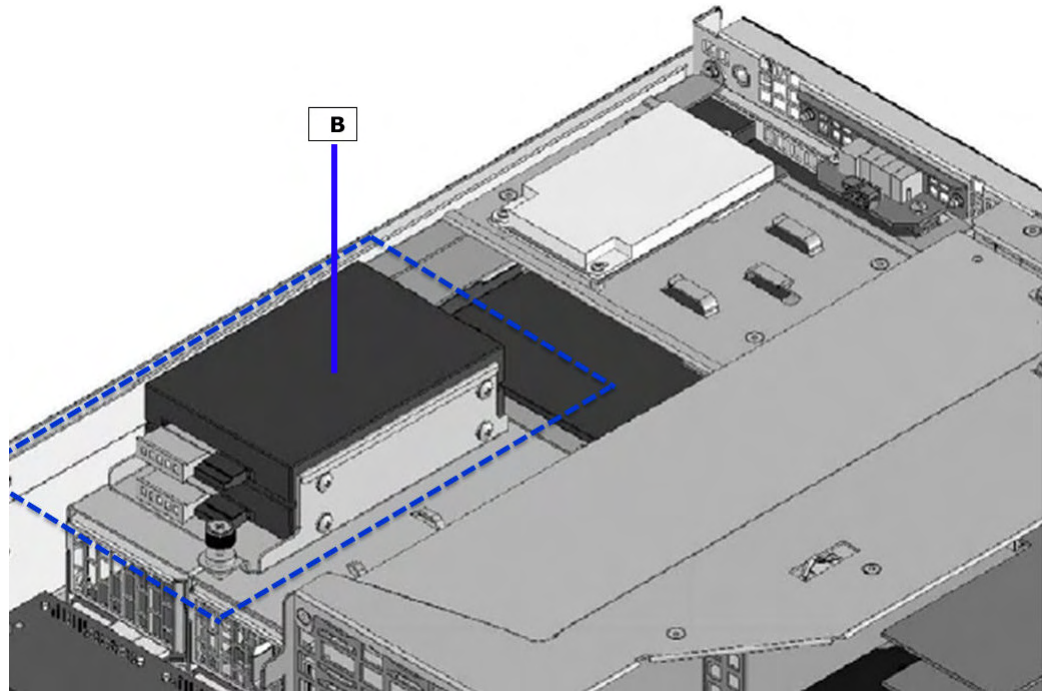

- | | |
|----|--|
| A. | Hot-Swap 3.5-inch Hard Drive Bays (12) |
| B. | Internal fixed 2.5-inch SATA Hard Drive Bays (2) |
| C. | Slimline SATA Optical Drive Bay (1) |

Figure 15. Optional Peripherals

Hard Disk Drive Carriers

The server system ships with 12 drive carriers for installing 12 SAS or Serial ATA (SATA) hot-swap drives.

Note: Drives can consume up to 17 watts of power each. Drives must be specified to run at a maximum ambient temperature of 45°C.

Note: The Intel® Server System SR2612UR does not support all SAS or Serial ATA (SATA) hard drives. For a web link to a list of supported hard drives, see [“Additional Information and Software”](#) on page -7.

Slimline Optical Drive Carrier

The slimline optical drive carrier can be used with a single slimline optical drive. One slimline carrier is included with your server system; the optical drive must be purchased separately.

The drive inside the chassis is NOT hot-swappable. The system power must be turned off to insert or remove the slimline optical drive carrier.

To use one of the drives provided by Intel, use the following order codes:

- Slimline DVD-ROM Drive: AXXSATADVDRM
- Slimline DVD-RW Drive: AXXSATADVDRWROM

Note: The Intel® Server System SR2612UR does not support all slimline optical drives. For a web link to a list of supported slimline optical drives, see [“Additional Information and Software”](#) on page -7. Intel provides accessory kits for these drives.

Control Panel

The Intel® Server System SR2612UR only has one control panel option..



Figure 16. Rear Control Panel

Item	Function	Color	State	Description
A.	Standby Power OK LED (+3.3V)	Green	Off	AC Power Off
			On	AC power on or DC power on
B.	System Status LED	Green	Solid On	System booted and ready
			Blink	Degraded
C.	System Status LED	Amber	Blink	Non-critical
			Solid On	Critical, non-recoverable
D.	System Identification LED	Blue	On	Identify active through command
			Off	No Identification
E.	Power Switch	N/A	N/A	N/A

SAS/SATA Midplanes

The midplane serves as the primary interface between the server board, hot-swap backplane, and control panel. Only one midplane is offered for this system:

- Active SAS midplane

Note: SATA connectors 6 and 7 are not used in the Intel® Server System SR2612UR.

Active Midplane

The following diagram show the location for each connector found on the active midplane.

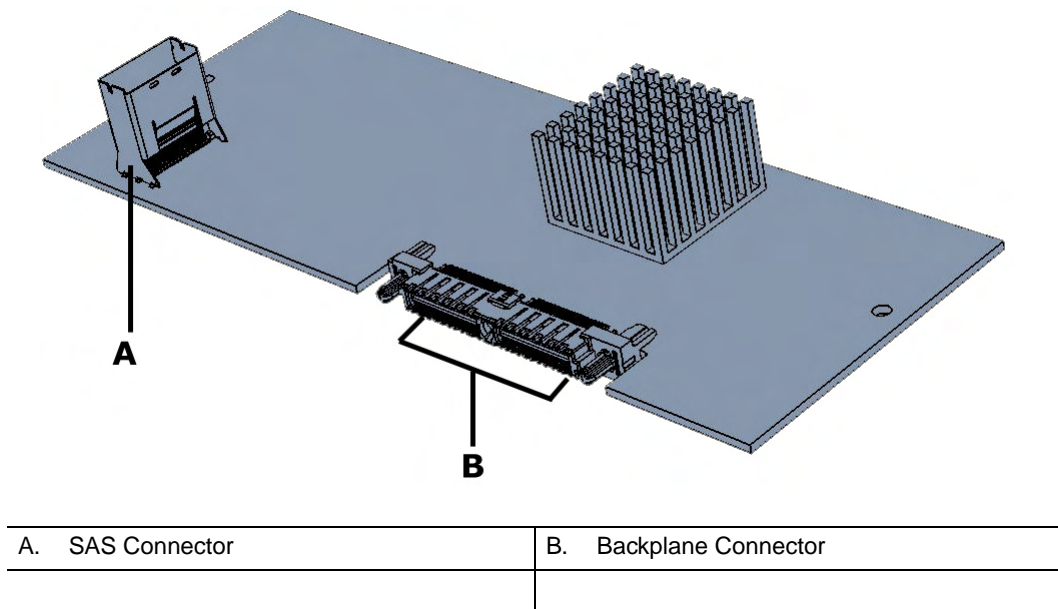
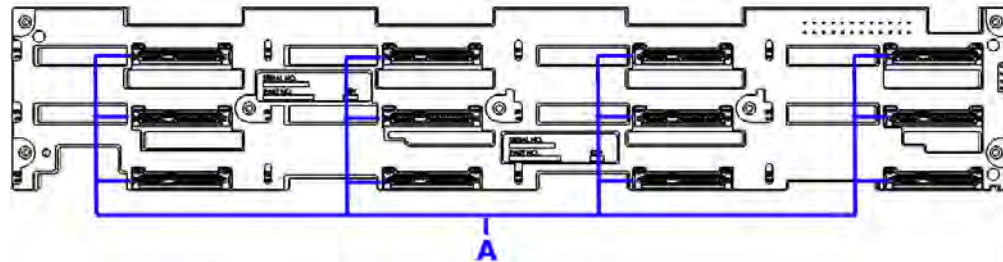

Figure 17. Active SAS Midplane Components

Hot-Swap SAS/SATA Backplane

The backplane serves as an interface between the midplane board and the system drives.

The hot-swap backplane provides support for both SAS and SATA hard drives. There are no hard drive cables that connect to the backplane. All hard drive control signals are routed from the midplane board, which plugs directly into the backplane.



A. SAS/SATA Hard Disk Drive Connectors	
--	--

Figure 18. 3.5-inch Hot-Swap SAS/SATA Backplane Components (Front View)

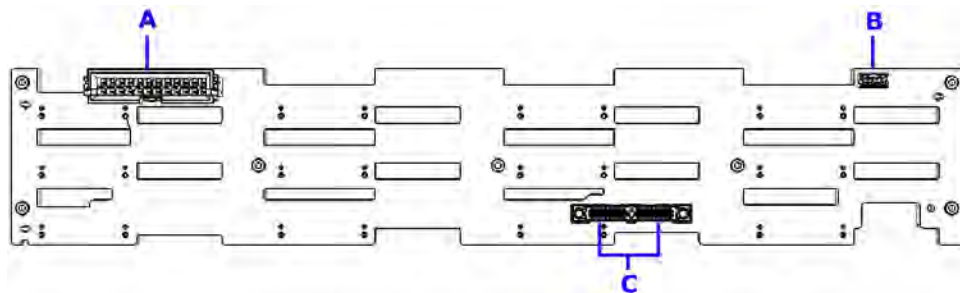

A. Backplane Power Connector	C. Midplane Board Connector
B. Server Board/Midplane GPIO Connector	

Figure 19. 3.5-inch Hot-Swap SAS/SATA Backplane Components (Rear View)

RAID Support

For RAID support on the active midplane, you should install an additional RAID controller.

For information on configuring RAID, see the *Intel® RAID Software User's Guide* that is included on the *Intel® Server Deployment Toolkit 3.0 CD*.

Advanced Management Options

Intel® Remote Management Module 3

The Intel® Remote Management Module 3 plugs into a dedicated connector on the server board and provides additional server management functionality to the server board.

This module provides a dedicated web server for viewing server information and remote control of the system. It also provides Remote KVM Redirection and USB Media Redirection allowing USB devices attached to the remote system to be used on the managed server.

Rack Mount Options

Your Intel® Server System SR2612UR can be mounted into a rack. Intel provides the following option to mount this server system into a rack:

- A basic slide rail kit designed to mount the system into a standard (19 inches by up to 34 inches deep) EIA-310D compatible server cabinet.

When installing the system into a rack, Intel recommends you install systems from the bottom of the rack to the top. In other words, install the first system in the rack into the bottom position of the rack, the second system in the second position from the bottom, and so on. For instructions on installing your chassis into a rack, see [“Installing Your Intel® Server System SR2612UR into a Rack \(Optional\)”](#) on page -30. These instructions are also included in the rail kit.

3 Hardware Installations and Upgrades

Before You Begin

Before working with your server product, pay close attention to the “[Safety Information](#)” on [page v](#) at the beginning of this manual.

***Note:** Whenever you service the system, you must first power down the server and unplug all peripheral devices and the AC power cord.*

Tools and Supplies Needed

- Phillips* (cross head) screwdrivers (#1 bit and #2 bit)
- Needle nosed pliers
- Anti-static wrist strap and conductive foam pad (recommended)

System References

All references to left, right, front, top, and bottom assume the reader is facing the front of the server system as it would be positioned for normal operation.

Preparing for Installation

1. Carefully read “[Safety Information](#)” on [page v](#) at the beginning of this manual.
2. Remove all the components from the packaging, inspect them for shipping damage, then place them on an antistatic surface until you are ready to use them.

If you are using new disk drives, allow them to acclimate to room temperature before installing them.
3. If you are installing the appliance in a rack, ensure that you have these tools available:
 - Phillips screwdriver
 - Bubble level
 - Arrange for someone to assist you during installation.
 - Ensure ahead of time that you have chosen a suitable location for the appliance and the rack. (See “[Safety Information](#)” on [page v](#) at the beginning of this manual.)

Installing Your Intel® Server System SR2612UR into a Rack (Optional)

If you are not installing your appliance into a rack, skip the remainder of this section and go to “Installing the Disk Drives” on page 33.

To install your appliance into a rack:

1. Ensure you have these rail kit components:
 - One right rail assembly
 - One left rail assembly
 - Ten 10-32 cage nuts (square hole cabinets)
 - Ten 10-32 speed nuts (round hole cabinets)
 - Ten 10-32 x 0.50 Phillips pan head screws
2. Ensure the four screws contained within the slider mechanism are loosened.

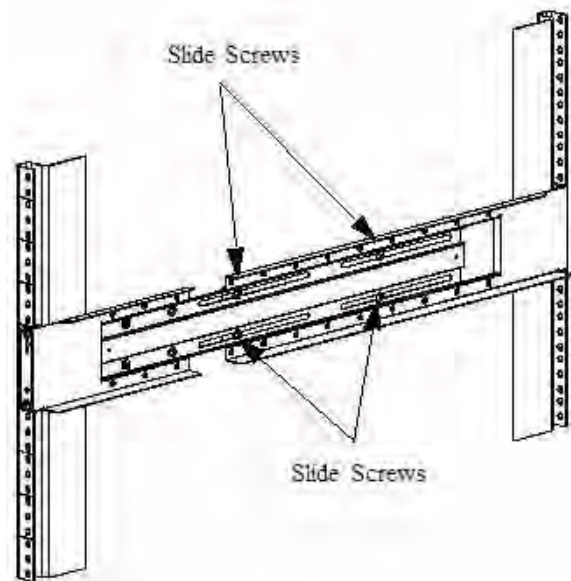

Figure 20. Slider Mechanism

3. Slide the front and rear portions of the rail away from each other until the length is correct for your cabinet. Secure the front and rear portions of the rail kit to the front and rear supports as shown in the following figure. Ensure all connections are tightened and secure.

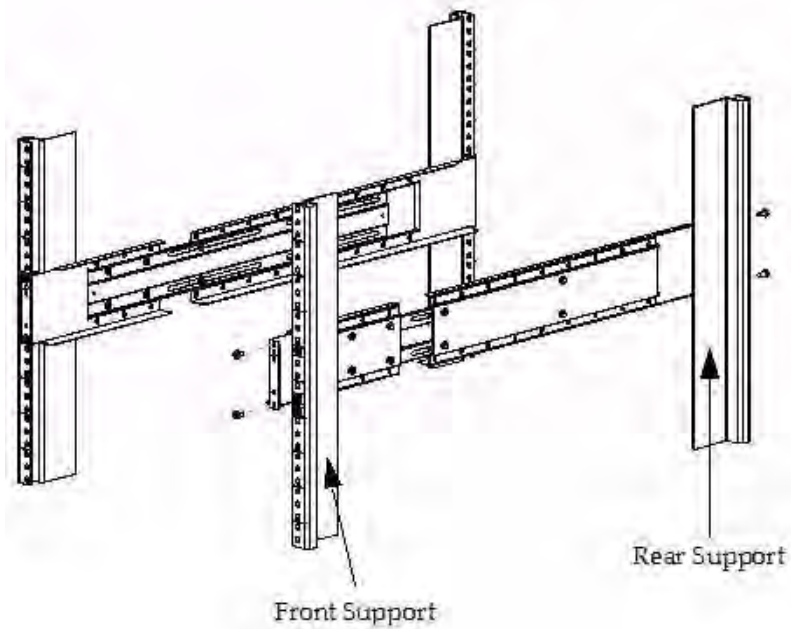

Figure 21. Securing the Front and Rear Portions of the Rail Kit

4. Tighten the four screws on each rail's slider mechanism.

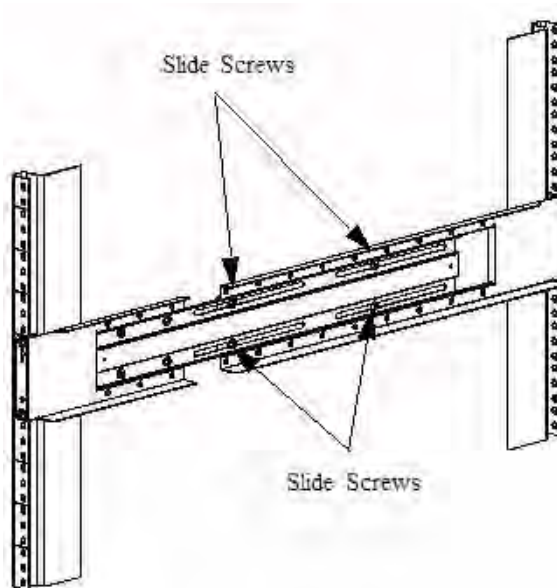

Figure 22. Tightening the Screws on the Rail's Slider Mechanism

Caution: A fully loaded appliance is heavy. To avoid personal injury, have someone help you lift the appliance.

5. Slide the appliance onto the rails, then push it all the way back until the rackmount ears are flush against the vertical supports and the appliance rests completely on the rails.

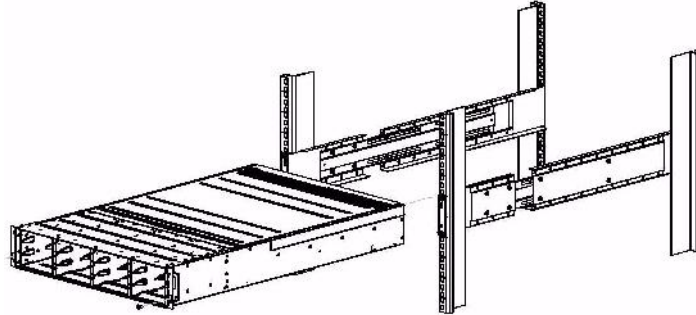

Figure 23. Sliding the Appliance onto the Rails

6. Secure both rackmount ears to the vertical supports using two of the 10-32 x .50-inch screws and carefully snap the plastic rack ear covers in place as shown. The rack installation is complete.

Installing the Disk Drives

Caution: Before installing new disk drives, acclimate them to room temperature. Store drives at room temperature for two hours prior to use.

Note: To install a disk drive or plastic blank into a carrier, refer to “[Drive Installation in the Drive Carrier](#)” on page 75 in this manual.

1. Select an open drive slot.
2. Hold the disk drive so the LEDs are on the left and the lever is fully open.
3. Slide the disk drive into the drive slot until the lever starts to close.

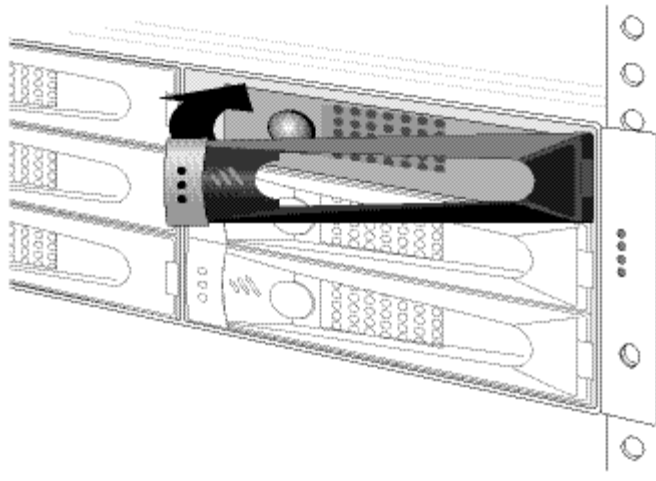

Figure 24. Sliding the Disk Drive into the Drive Slot

4. Push the lever until it meets the latch on the left side of the drive slot and clicks into place.

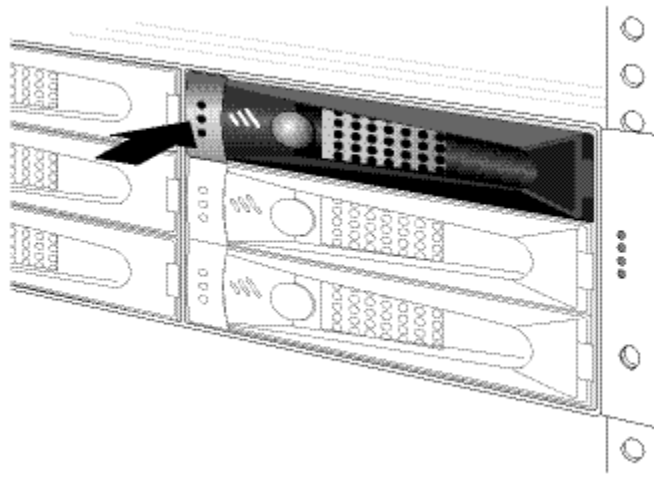

Figure 25. Pushing the Lever Until It Meets the Latch on Left Side of the Drive Slot

5. Repeat for all remaining disk drives. Drive installation is easier when installing drives from right to left in the enclosure.

Note: *To maintain proper airflow and cooling, you must install a disk drive carrier populated with an actual disk drive or plastic drive blank assembly in every slot of the enclosure. Under no circumstances should the appliance be operated with empty drive slots or with empty drive carrier assemblies as this could cause damage to the LEDs on the backplane and/or create thermal problems.*

Removing a Disk Drive Carrier Assembly (or Drive Blank)

Note: For disk drive installation instructions, see “Installing the Disk Drives” on page 33.

Important Safety Precautions

Before you remove a populated disk drive carrier, read these important notes:

- To avoid data loss, stop all I/O activity on the disk drive before removing it. (Removing a disk drive during I/O activity could also hang the host system.)
- *Do not* attempt to remove more than one disk drive or blank drive carrier at a time. Damage to the drive carrier can occur if adjacent disk drives are removed at the same time.
- To maintain proper airflow and cooling inside the enclosure, install either a populated disk drive carrier or a plastic drive blank assembly into the empty drive slot as quickly as possible.

If you will be installing a replacement drive carrier populated with a new disk drive, allow it to acclimate to room temperature before continuing.

Removing a Disk Drive

Warning: *Disk drives spin at high speed. When removing a Disk Drive Carrier from an enclosure with power on, unlatch the carrier and allow the drive to completely spin down for approximately 15-20 seconds before sliding the carrier out of the enclosure. Removing the Disk Drive Carrier assembly while the drive is spinning could cause injury and may cause severe damage to the disk drive.*

To remove a populated disk drive carrier assembly (or drive blank assembly):

1. Press the button on the assembly to release the lever.

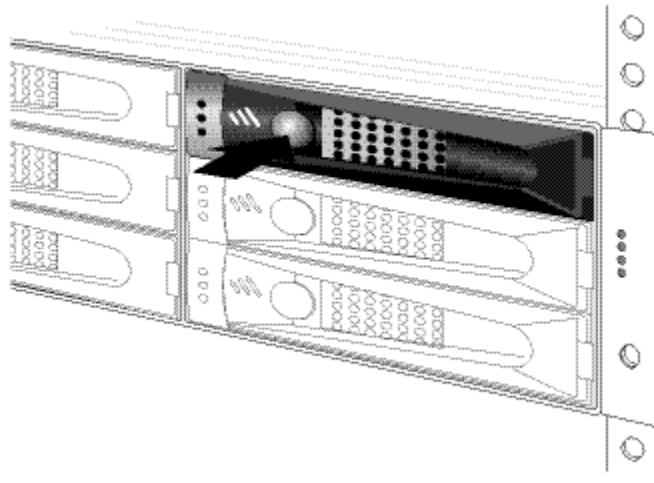

Figure 26. Pushing the Button on the Assembly

2. Gently pull open the lever.
The drive carrier or drive blank unlocks.

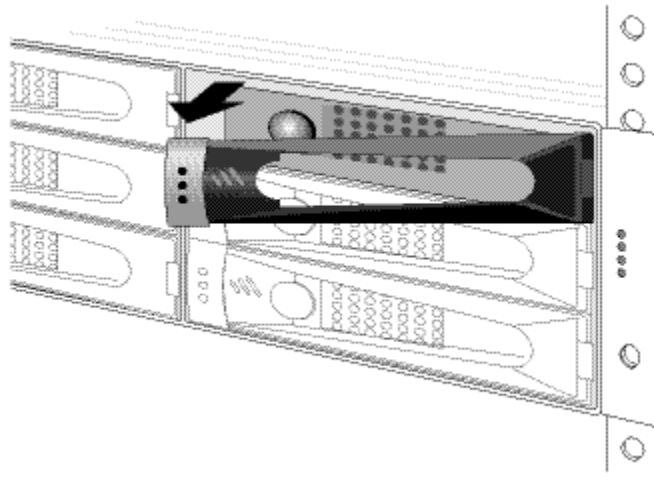

Figure 27. Drive Carrier Unlocked

3. If the enclosure is powered on, allow the disk drive to fully spin down (wait approximately 15-20 seconds).

Warning: Removing a populated disk drive carrier before it has fully spun down may result in disk drive damage and possible personal injury.

4. Gently pull the disk drive carrier or drive blank out of the enclosure.
5. Immediately replace the disk drive carrier assembly or install a drive blank assembly to maintain correct airflow and cooling. For more information on installing disk drives, see [“Installing the Disk Drives”](#) on page 33.

Installing the Operating System

The Intel® Server System SR2612UR is now ready to have the operating system installed. Please contact your IT representative to perform this installation or if you are installing it yourself, please follow the general guidelines below.

1. Connect the power cords to the rear of the unit.
2. Connect a monitor, keyboard, and mouse to the rear connections on the enclosure.
3. Turn on power to the enclosure by pressing the power button on the rear of the enclosure.
4. Insert the operating system CD/DVD.
5. Follow the instructions for installing the operating system.
6. If you want to install additional drivers or programs (for the PCI cards or other devices), you should also install them at this time.

The system is now ready to boot up. Booting the system may take several minutes.

Connecting Your Intel® Server System SR2612UR to a Host Server

Connecting to the 1 GE iSCSI LAN Data Ports

Consult your operating system/software user guide for details on assigning LAN IP addresses to the integrated system 1GE iSCSI data ports.

For iSCSI applications running on the Intel® Server System SR2612UR, Ethernet connectivity is required. The following figure illustrates a direct iSCSI connection between the host system and one of the two Ethernet ports on the Intel® Server System SR2612UR. An Ethernet switch and/or optional internal 1GE or 10GE iSCSI PCI card may also be used to make these connections.

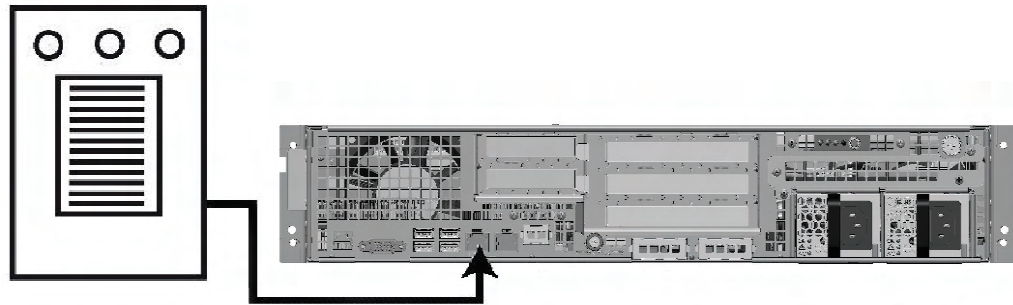

Figure 28. Establishing a Connection to the LAN Data Port

If you are not connecting additional enclosures, continue with “Powering On” on page 38.

Connecting Additional Enclosures

You can expand your configuration with storage enclosures depending on the number of drives supported by the SAS or SATA HBA.

You can include enclosures installed with SAS disk drives and enclosures installed with SATA disk drives in the same daisy-chain. Refer to the SAS or SATA HBA User Guide for a list of supported expansion enclosures.

Connect a SAS cable to the expansion port on the rear of the enclosure. Connect the other end to the controller SAS port on the rear of the expansion enclosure.

Powering On

1. Using the included power cords, connect each Power Supply (PS) unit to an AC power source. (It is recommended that you use an uninterruptible power supply to protect your appliance.)

Note: The dual 2.5-m power cords included with the Intel® Server System SR2612UR have domestic North American NEMA 5-15 plugs. If required, you can obtain International power cords locally (for example, via the Internet at <http://www.interpowers.com>).

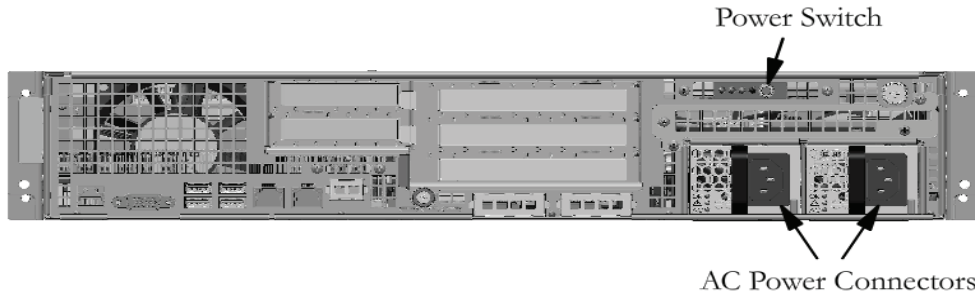

Figure 29. Powering-On

2. Press the Master Power Switch to power on the unit.

Note: Note: On power up the internal server board on the Intel® Server System SR2612UR may take a couple of minutes to complete initialization and operating system boot activities.

The installation is complete. You can begin using your Intel® Server System SR2612UR.

Installing a 2.5-inch Internal Drive

The Intel® Server System SR2612UR supports up to two (2) internal 2.5-inch SATA drives. They are connected directly to the CPU server board and provide the capability to run the operating system from these drives.

Complete the following steps to install one or more 2.5-inch internal drives in the Intel® Server System SR2612UR. For a list of supported drives, contact your Intel sales representative.

1. Ensure the AC power cord(s) are disconnected from the enclosure.
2. Remove the top cover from the enclosure by loosening the captive screw with a Phillips screwdriver on the right-rear of the enclosure.
3. Slide the top cover back and lift it from the enclosure.
4. Locate the 2.5-inch drive sled as shown.

5. Remove the drive sled by loosening the captive thumbscrew.

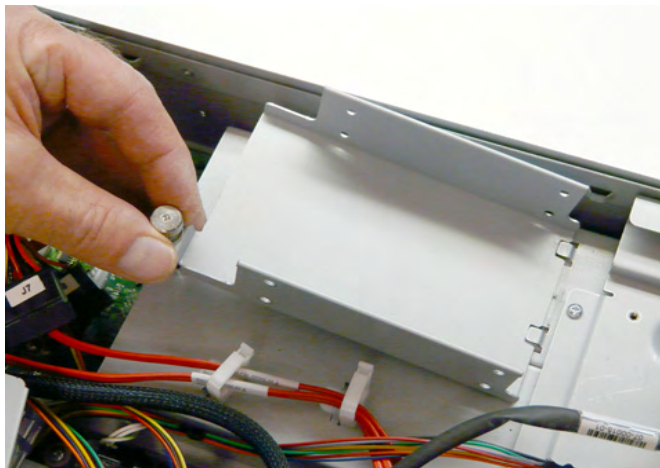

Figure 30. Removing the drive sled

6. Position the drive(s) as shown and secure using the 4 screws provided with the drive. If installing only one drive, locate the drive on the bottom shelf of the sled.

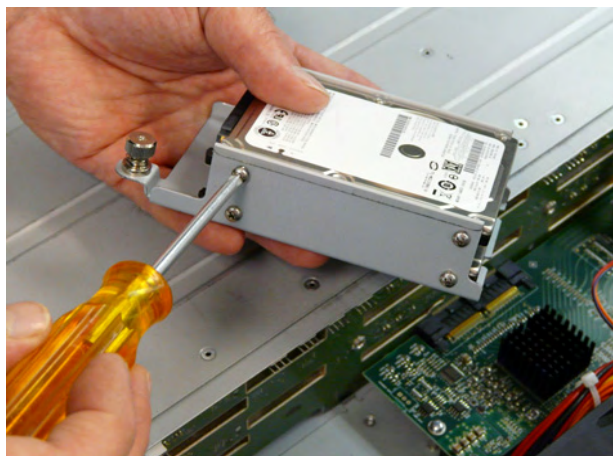

Figure 31. Installing the boot drives

7. Reinstall the drive sled and tighten down the captive thumbscrew.
8. The power cables for the 2.5-inch drives are located near the drive sled. Attach the cable(s) to the drive(s).
9. Carefully remove the CPU server board air duct.

- Using the SATA cable supplied with the drive, route the cable from each disk drive to the CPU server board SATA connectors.

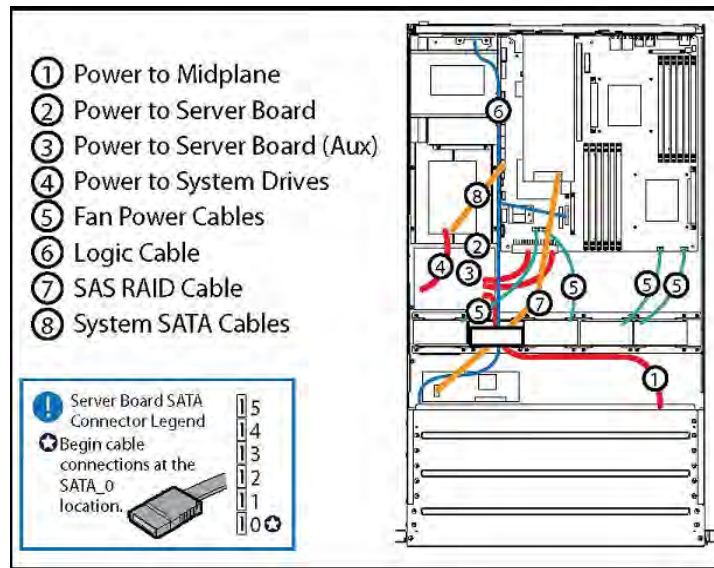

Figure 32. Connections Diagram

- Carefully reinstall the CPU server board air duct.
- Reinstall the top cover and tighten the captive screw.
- Reinstall the power cord(s).

DVD Installation

The Intel® Server System SR2612UR supports an optional DVD. Complete the following steps to install a DVD drive in the Intel® Server System SR2612UR.

- Ensure the AC power cord(s) are disconnected from the enclosure.
- Remove the top cover from the enclosure by loosening the captive screw with a Phillips screwdriver on the right rear of the enclosure.
- Slide the top cover back and lift it from the enclosure.
- On the rear of the enclosure, locate the removable DVD cover plate.
- Remove the four screws and cover plate using a Phillips* screwdriver shown in the following figure.



Figure 33. Removing the four screws and cover plate

6. Looking into the top of the enclosure, locate the DVD tray screw and remove. This screw will be re-used.

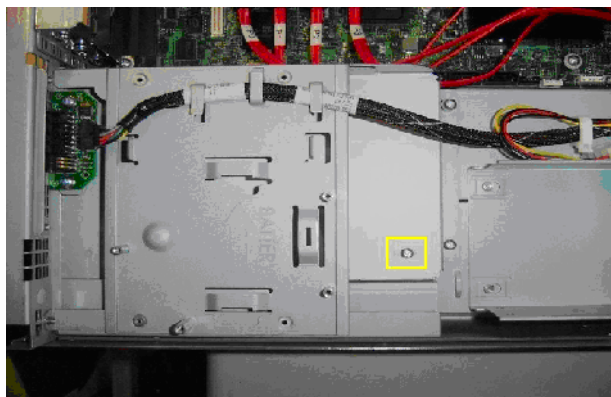

Figure 34. Removing the four screws and cover plate

7. Slide the DVD tray out of the enclosure.
8. Position the DVD unit as shown in the following figure and carefully snap the unit in place by aligning the pointed tabs with the screw holes on the DVD unit.



Figure 35. Position the DVD Unit

9. Slide the DVD / tray assembly back into the enclosure and anchor it using the screw that was removed in Step 7.
10. Using the slimline cable shipped with the system, connect the power end of slimline cable to the power cable located in the enclosure and the SATA end of slimline cable to the CPU server board. If 2.5-inch drives are installed, connect the SATA cable to the SATA2 connector.



Figure 36. Routing the Cable From the DVD Unit to the Server Board

11. Reinstall the top cover and tighten the captive screw.
12. Reinstall the power cord(s).

Replacing a Fan

You should replace a defective fan as soon as possible to maintain proper cooling in the enclosure. Complete the following steps to remove and install a fan in the Intel[®] Server System SR2612UR.

1. Ensure the AC power cord(s) are disconnected from the enclosure.
2. Remove the top cover from the enclosure by loosening the captive screw with a phillips screwdriver on the right-rear of the enclosure.
3. Slide the top cover back and lift it from the enclosure.
4. If the defective fan is located on the server board side of the enclosure, carefully remove the system air duct to allow access to the fan (reference item G on the System component diagram).
5. Remove the defective fan by pushing the top of the fan towards the rear of the enclosure until the fan pops free.

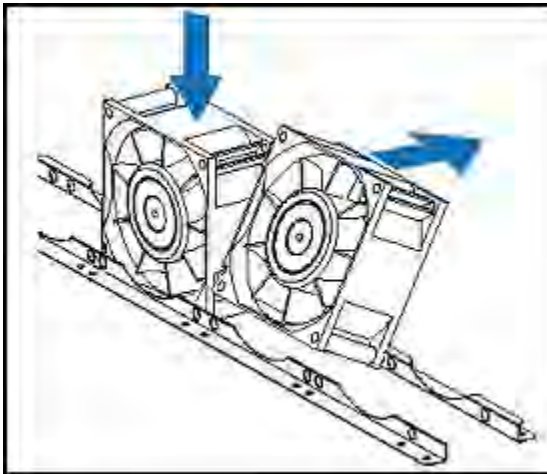

Figure 37. Removing the Defective Fan

6. Carefully disconnect the 4-wire connector from the PCB (note the wire routing) and remove the defective fan from the enclosure.

Installing a Fan

Installing a fan is the opposite of “[Replacing a Fan](#)” on page 43.

1. Carefully connect the 4-wire connector onto the pc board. Route the wires so that they will not interfere with other components and snap the fan back into place by aligning the mounting holes with the spring clip dimples. Press the fan downward until it snaps into place.
2. Carefully replace the system air duct if it was removed in [Step 4](#).
3. Reinstall the top cover and tighten the captive screw.
4. Reinstall the power cord(s).

Midplane Board Replacement

Complete the following steps to remove and install a midplane in the Intel® Server System SR2612UR.

1. Ensure the AC power cord(s) are disconnected from the enclosure.
2. Remove the top cover from the enclosure by loosening the captive screw with a Phillips screwdriver on the right-rear of the enclosure.
3. Slide the top cover back and lift it from the enclosure.
4. Locate the midplane (located between the backplane and fans).

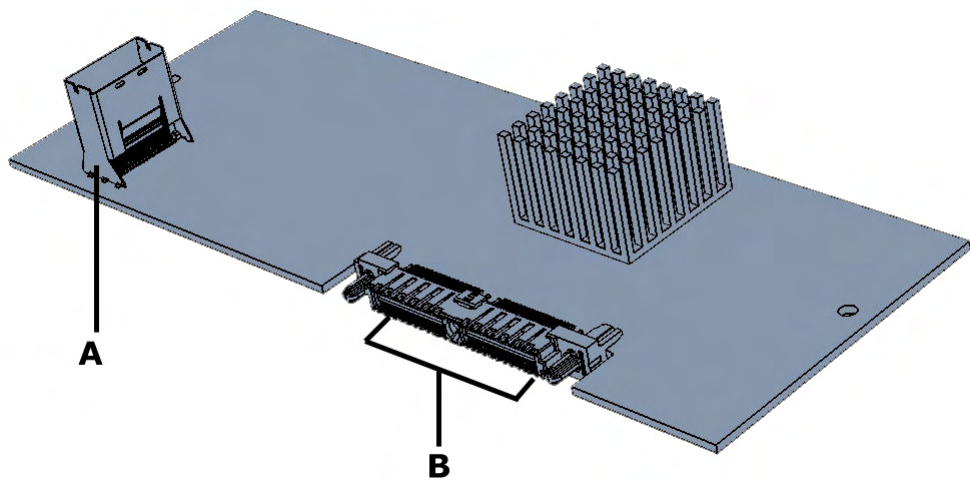

Figure 38. Midplane

5. Disconnect the I/O cable by depressing the release tab and pulling the cable upward.

Caution: You must depress the I/O SAS cable release tab when removing the cable to prevent I/O connector damage.

6. Remove the two screws holding the midplane in place.

7. Carefully disconnect the midplane from the backplane as shown in the following figure.

To remove :

1. Disconnect SAS cable by depressing release tab and pulling cable upward.
2. Remove 2x screws at locations shown
3. Disconnect IO from midplane in direction shown

 **CAUTION:** SAS cable release tab must be depressed when removing cable to prevent IO damage.

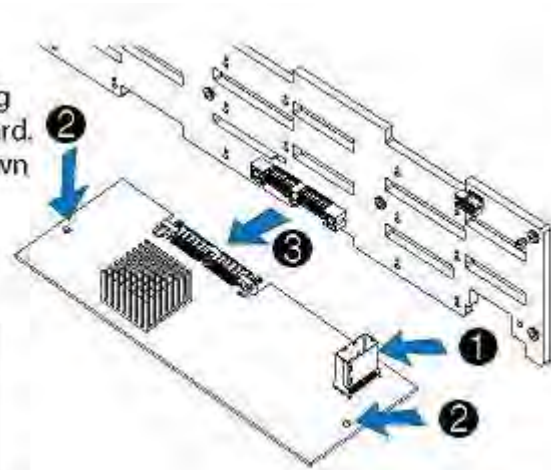

Figure 39. Disconnecting the Midplane from the Backplane

8. Carefully connect the new midplane to the backplane.
9. Reinstall the two screws to hold the midplane in place. Be careful not to overtighten the screws.
10. Reconnect the I/O SAS cable by gently inserting into the metal socket. Ensure the cable was reinstalled correctly.
11. Reinstall the top cover and tighten the captive screw.
12. Reinstall the power cord(s).

Memory Installation

The server board supports up to 12 DDR3 DIMMs, six per processor. The maximum memory capacity is 96 GB.

Note: *The memory slots associated with a particular processor are unavailable if the given processor socket is not populated with a CPU chip.*

Memory recommendations:

1. It is recommended that the same type, size, and manufacturer of DIMM module be used throughout the enclosure. Using different memory vendors in the same enclosure may cause unexpected results when booting and running the machine.
2. It is recommended that the same overall size of memory is used for both processors.

For a list of supported memory vendors and capacities, contact your Intel sales representative.

Mixed speed DIMMs are accommodated by using the highest common frequency of all memory modules installed.

To replace or add memory to the Intel® Server System SR2612UR, complete the following steps.

1. Ensure that the AC power cord(s) are disconnected from the enclosure.
2. Remove the top cover from the enclosure by loosening the captive screw with a Phillips screwdriver on the right-rear of the enclosure.
3. Slide the top cover back and lift it from the enclosure.
4. Carefully remove the system air duct over the CPU server board.
5. Referencing the following Server Board Configuration Diagram, memory DIMMs must be installed / filled in the following order:
 - Slot A1, Slot B1, Slot C1 (CPU 1)
 - Slot D1, Slot E1, Slot F1 (CPU 2)Once the above slots are full, then:
 - Slot A2, Slot B2, Slot C2 (CPU1)
 - Slot D2, Slot E2, Slot F2 (CPU2)

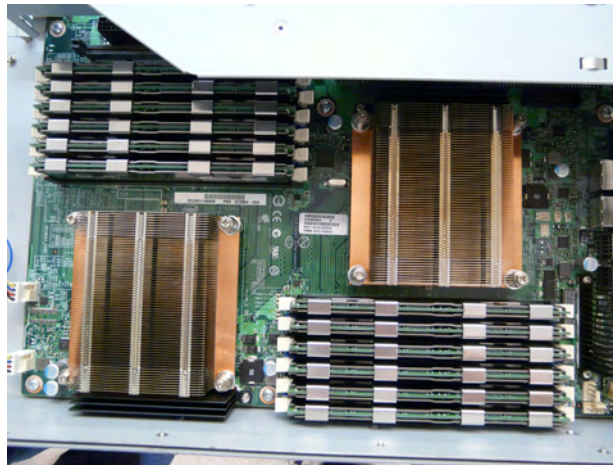

Figure 40. Memory Slots on the Server Board

Note: You can populate memory in any order only if the CPU server board is running in Channel Independent Mode. Please reference the CPU server board functional specification if the enclosure will be running in Channel Independent Mode. Also refer to the specification if the server board will be running in either Channel Sparing or Channel Mirroring Mode as there are specific memory installation configurations required.

6. To install the DIMM, open the release levers on each side of the memory socket and press down on the DIMM until the release levers snap closed.

Note: The DIMMs are “keyed” so they can only be inserted one way in the socket.

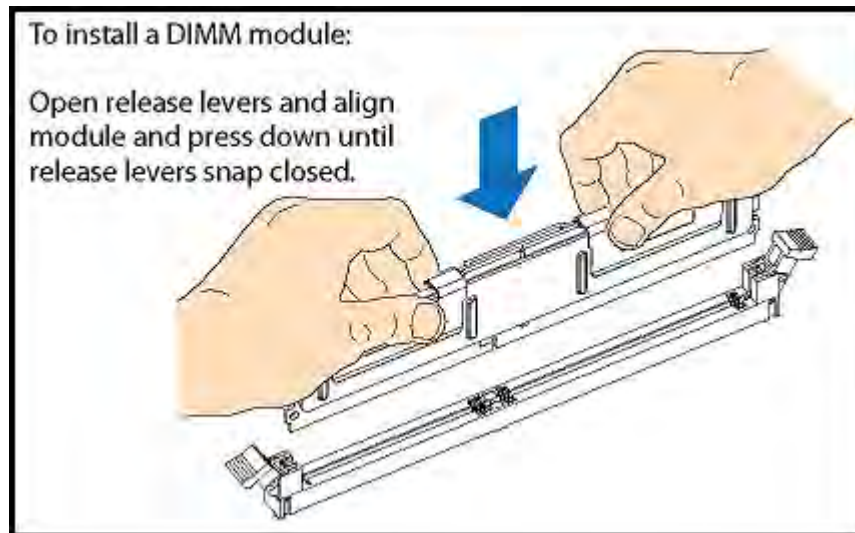

Figure 41. Installing a DIMM

7. Once the DIMMs are installed, carefully replace the system air duct over the server board.
8. Reinstall the top cover and tighten the captive screw.
9. Reinstall the power cord(s).

PCI Card and Battery Installation

The Intel® Server System SR2612UR supports to five PCI-E option cards. A typical configuration uses a PCI-E-based RAID card to communicate with the 12 drive slots.

Complete the following steps to install a PCI-E card in the Intel® Server System SR2612UR.

1. Ensure the AC power cord(s) are disconnected from the enclosure.
2. Remove the top cover from the enclosure by loosening the captive screw with a Phillips screwdriver on the right rear of the enclosure.
3. Slide the top cover back and lift it from the enclosure.
4. Locate the PCI cage assembly and loosen the two (2) captive thumbscrews.
5. As shown in the following figure, carefully lift the entire PCI cage assembly out of the enclosure.

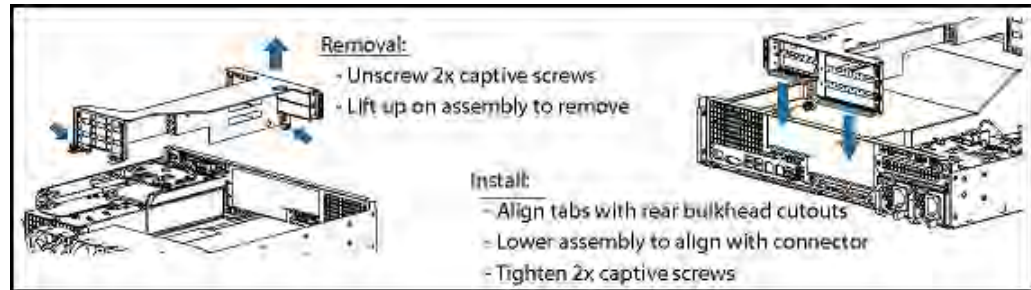

Figure 42. Lifting the PCI Cage Assembly Out of the Enclosure

6. Remove the metal blank filler for the appropriate slot you will be plugging the card into (the top slot is used for the first installed card).
7. Carefully install the PCI card starting at the top slot of the PCI cage. PCI cards are keyed so they cannot be installed backwards.
8. To reinstall the PCI cage assembly, line up the tabs at the bulkhead cutouts on the rear of the enclosure.
9. Carefully lower the assembly and align the PCI cage circuit card with the CPU server board connector. Press into place.
10. Tighten the two (2) captive screws on the PCI card cage assembly.
11. Depending on the type of card installed, there may be cables that have to be routed. In the case of a RAID card, you must route the SAS cable through the fan assembly (where other cables are routed) and connect to the I/O module located just behind the midplane.

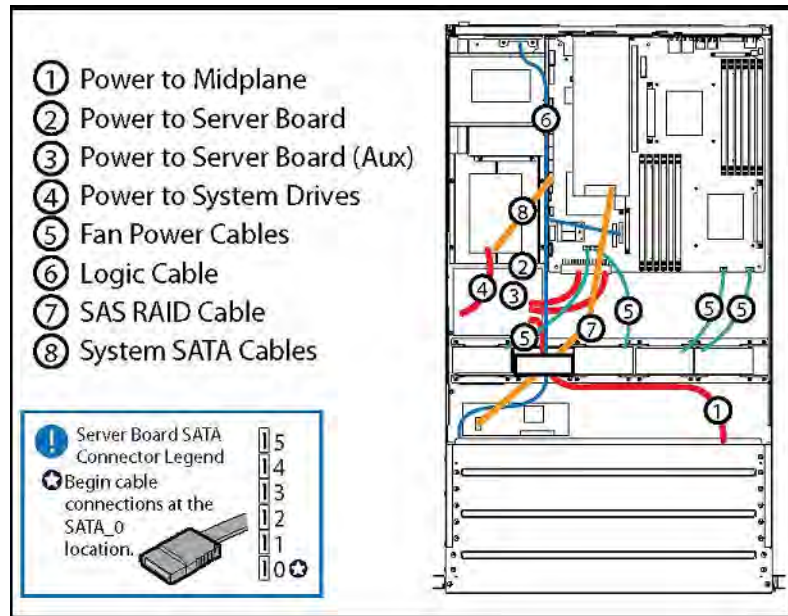

Figure 43. Routing the Cables Through the Fan Assembly

12. If there is an external battery associated with the PCI card, it must be mounted with the supplied mounting screws in the location indicated in the following figure

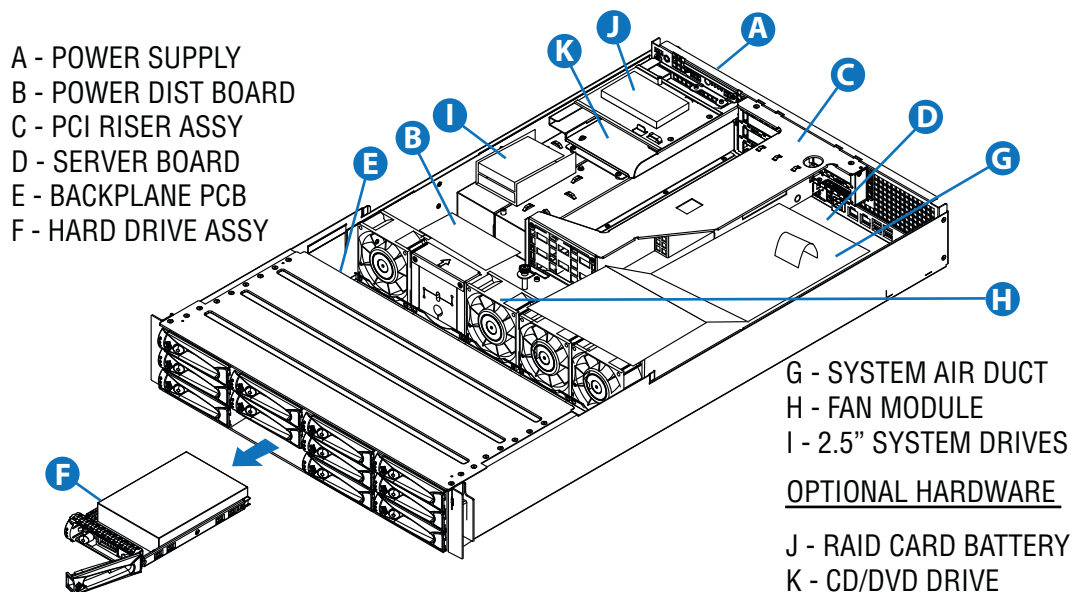

Figure 44. Mounting an External Battery

13. Reinstall the top cover and tighten the captive screw.

14. Reinstall the power cord(s).

Power Supply Replacement

Complete the following steps to remove and install a power supply in the Intel® Server System SR2612UR.

1. Ensure the AC power cord(s) are disconnected from the enclosure.
2. Remove the top cover from the enclosure by loosening the captive screw on the right-rear of the enclosure with a Phillips screwdriver.
3. Slide the top cover back and lift it from the enclosure.
4. Remove the power supply by pushing in and holding the green latch in the directions shown in the following figure.

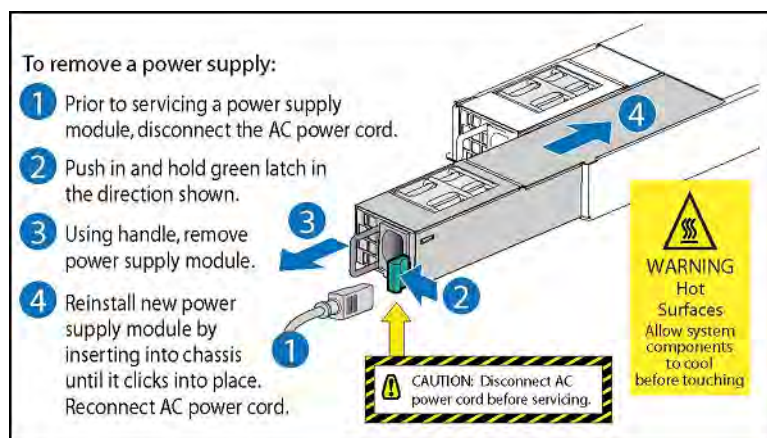

Figure 45. Removing the Power Supply

5. Using the handle, carefully slide the power supply out of the enclosure chassis.
6. Reinstall a new power supply by inserting it into the chassis enclosure until it clicks into place.
7. Reinstall the top cover and tighten the captive screw.
8. Reinstall the power cord(s).

Replacing the Backplane Board

The following sections describe how to replace the backplane board.

Removing the Backplane Board

Observe ESD precautions when servicing this unit. At a minimum, use an ESD grounded wrist strap when handling electrical components. Where possible utilize a grounded ESD mat to place drives and components on. For more information, refer to “[Safety Information](#)” on page 123.

1. Power down the enclosure and remove the power cord(s).
2. Remove all disk drives. Note their slot location in the enclosure.
3. Remove the top cover from the enclosure by loosening the captive screw with a Phillips screwdriver on the right-rear of the enclosure.
4. Slide the top cover back and lift it from the enclosure.
5. Remove the main power connector from the backplane as shown in Figure 46.

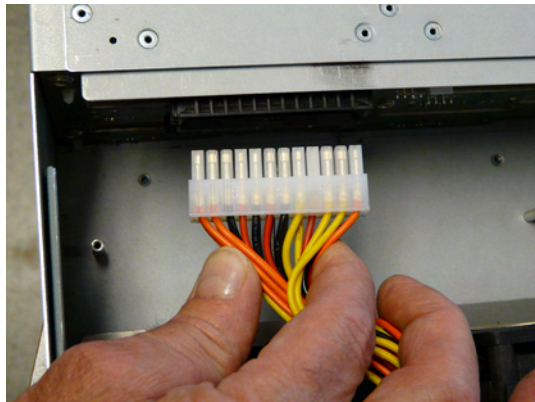

Figure 46. Removing the Main Power Connector from the Backplane

6. Remove the logic cable connector from the backplane as shown in Figure 47



Figure 47. Removing the Logic Cable Connector from the Backplane

7. Remove the midplane from the enclosure as detailed in the User Guide appendix. (Remove the I/O SAS cable and the two (2) screws holding the midplane in place, then carefully disconnect the midplane from the backplane.)

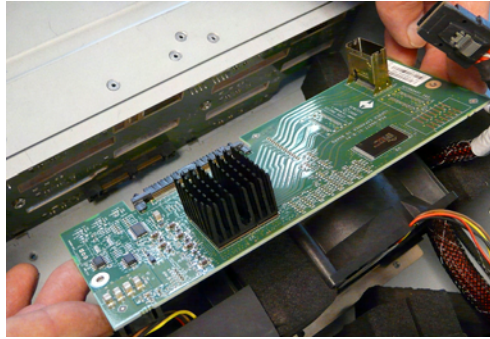

Figure 48. Removing the Midplane from the Enclosure

8. Using an extended Phillips head screwdriver reach in from the front of the enclosure and remove the seven (7) screws attaching the backplane



Figure 49. Removing the Screws that Attach the Backplane

9. Carefully pull back on the top of the backplane and lift it out of the enclosure



Figure 50. Pulling Back the Backplane and Lifting It Out of the Enclosure

Installing and Removing the RAID Battery Backup Unit

Installing the RAID Battery Backup Unit (BBU)

Warning: *Observe ESD precautions when servicing this unit. At a minimum utilize an ESD grounded wrist strap when handling electrical components. Where possible utilize a grounded ESD mat to place drives and components on.*

To install the RAID battery backup unit, follow these steps:

1. Power down the enclosure and remove the power cord(s).
2. Remove all disk drives. Note their slot location in the enclosure.
3. Remove the top cover from the enclosure by loosening the captive screw with a Phillips screwdriver on the right-rear of the enclosure.
4. Slide the top cover back and lift it from the enclosure.
5. Locate the battery mounting plate in the enclosure as shown below

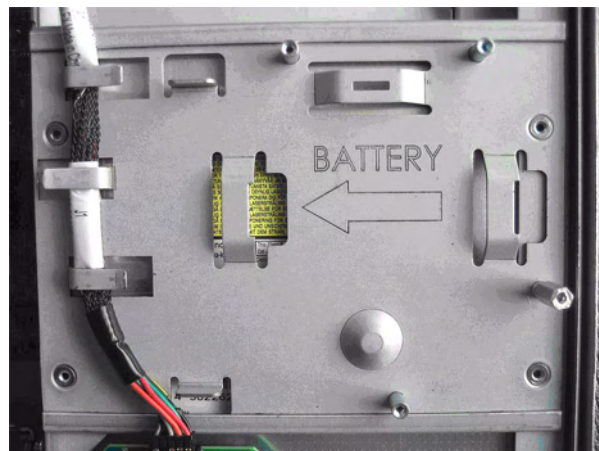

Figure 51. Locate the battery

6. Remove the standoff from the battery plate as shown below.

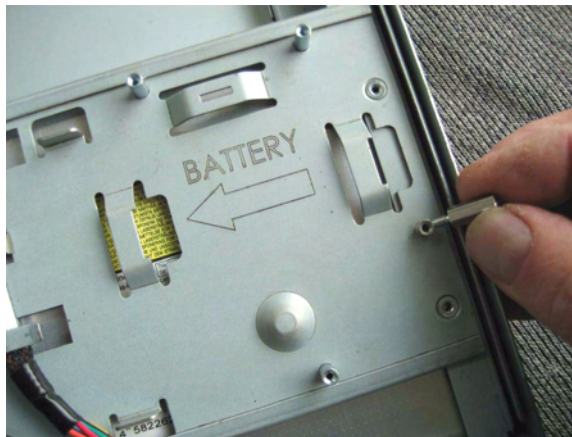

Figure 52. Remove the standoff

7. Align the battery pack as shown (with cable installed), and put into place by inserting the plastic tabs into the slots and sliding the pack in the direction of the arrow on the battery plate until the unit snaps into place.

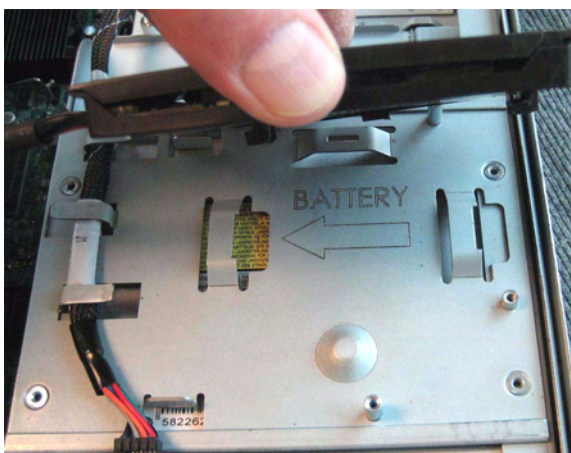

Figure 53. Align the battery pack

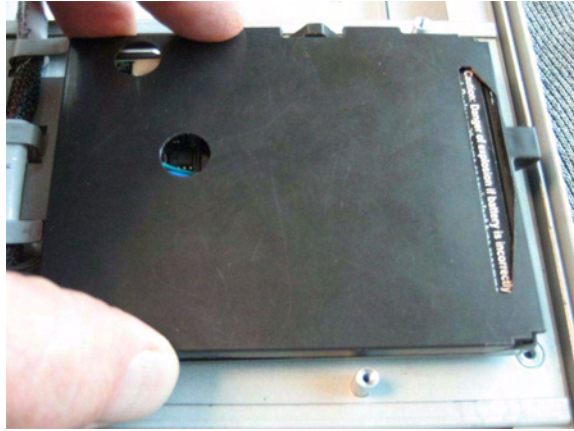

Figure 54. Aligning the battery pack

8. Replace and tighten the standoff that was removed in step 6

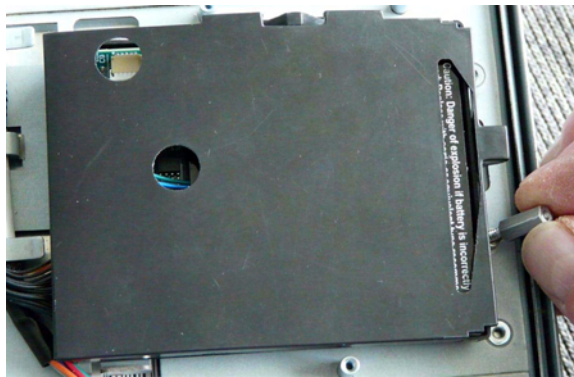

Figure 55. Replace and tighten standoff

9. Route the cable from the battery pack as shown below.

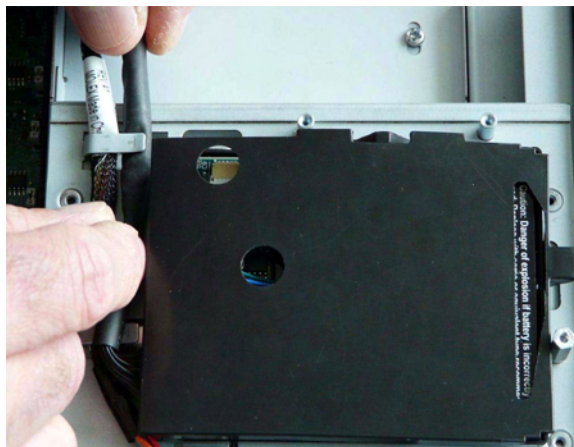

Figure 56. Route the cable

10. Connect the cable to the installed PCI RAID board as shown below

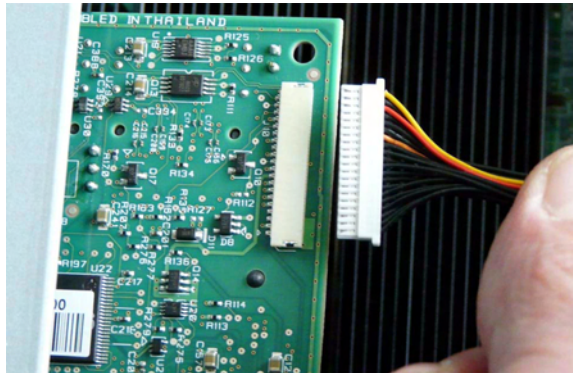

Figure 57. Connect the cable to PCI RAID Card

11. Reinstall the top cover and tighten the captive screw.
12. Reinstall the power cords.

Installing and Removing the Server Board

Removing the Server Board

To remove the server board, follow these steps:

1. Power down the enclosure and remove the power cord(s).
2. Remove the top cover from the enclosure by loosening the captive screw with a Phillips screwdriver on the right-rear of the enclosure.
3. Slide the top cover back and lift it from the enclosure.
4. Remove the processor air duct.
5. Remove the PCI riser assembly.
6. Remove the Intel[®] RMM3, if installed.
7. Disconnect power cables, P1, P2, P3 and Front Panel logic cable, from Motherboard as shown below.

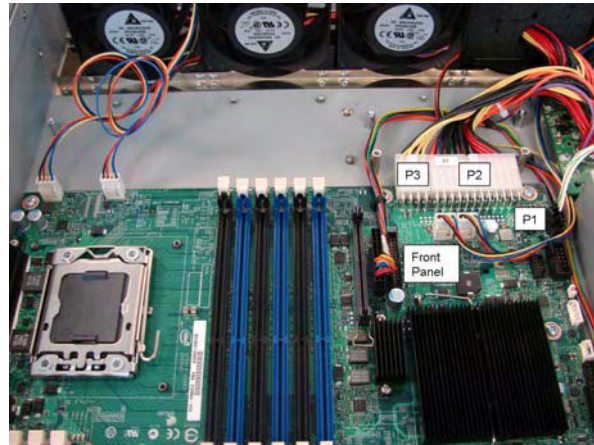

Figure 58. Disconnect the power cables

8. Disconnect fan cables, FAN 1, FAN 2, FAN 3 and FAN 4 from Motherboard as shown below

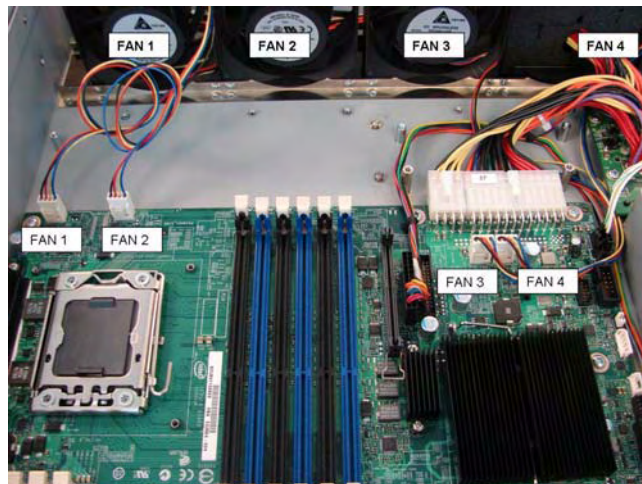

Figure 59. Disconnect the fan cables

9. Remove memory.
10. Remove the processor heatsink(s) and processor(s).
11. Remove the nine screws from the server board and lift the server board from the server system as shown below.

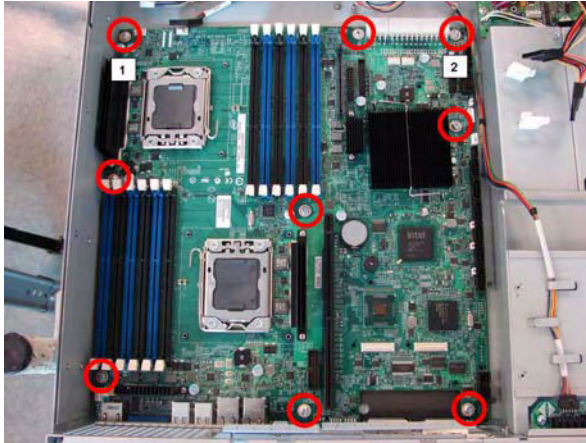

Figure 60. Remove the screws

12. Install the replacement server board.

Installing the Server Board

To install the server board, follow these steps:

1. Install Motherboard into chassis by tilting the board and inserting the connectors into the proper openings on the rear bulkhead as shown below. When the connectors are placed into the proper openings, slowly place the board into the chassis without causing any damage to the bottom side components.



Figure 61. Installing the server board

2. Attach the server board with nine screws.

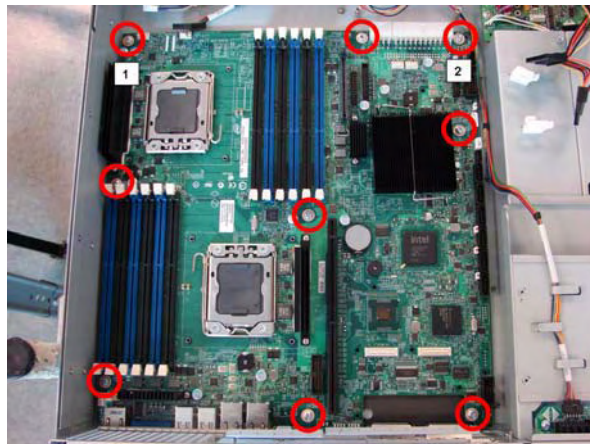

Figure 62. Attach the screws

3. Install power cables, P1, P2, P3 and Front Panel logic cable, into Motherboard as shown below.

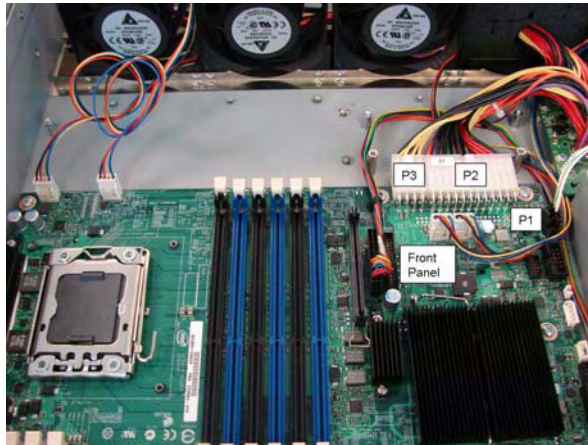

Figure 63. Installing power cables

4. Install fan cables, FAN 1, FAN 2, FAN 3 and FAN 4 into Motherboard as shown below.

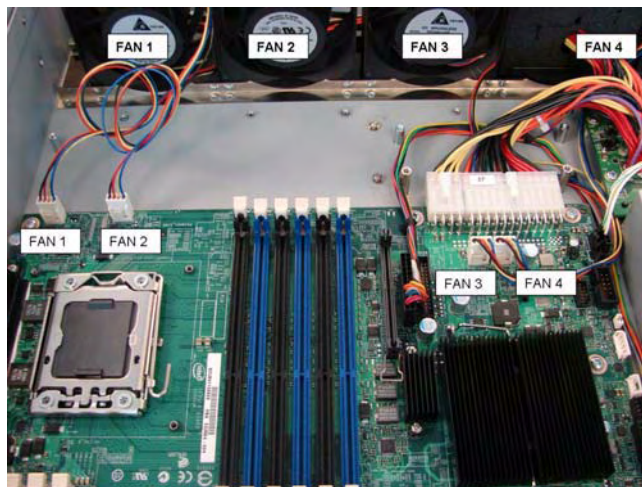

Figure 64. Install the fan cables

5. Install memory.
6. Install the processor(s).
7. Install processor heatsink(s).
8. If necessary, install the Intel[®] RMM3.
9. Install the PCI riser assembly.
10. Install the processor air duct.
11. Install the top cover and tighten the captive screw.
12. Install the power cords.

Replacing the Backup Battery

The lithium battery on the server board powers the RTC for up to 10 years in the absence of power. When the battery starts to weaken, it loses voltage, and the server settings stored in CMOS RAM in the RTC (for example, the date and time) may be wrong. Contact your customer service representative or dealer for a list of approved devices.

Warning: *Danger of explosion if battery is incorrectly replaced. Replace only with the same or equivalent type recommended by the equipment manufacturer. Discard used batteries according to manufacturer's instructions.*

Advarsel: Lithiumbatteri - Eksplosionsfare ved fejlagtig håndtering. Udskiftning må kun ske med batteri af samme fabrikat og type. Levér det brugte batteri tilbage til leverandøren.

Advarsel: Lithiumbatteri - Eksplosjonsfare. Ved utskifting benyttes kun batteri som anbefalt av apparatfabrikanten. Brukt batteri returneres apparatleverandøren.

Warning: Explosionsfara vid felaktigt batteribyte. Använd samma batterityp eller en ekvivalent typ som rekommenderas av apparattillverkaren. Kassera använt batteri enligt fabrikantens instruktion.

Varoitus: Paristo voi räjähtää, jos se on virheellisesti asennettu. Vaihda paristo ainoastaan laitevalmistajan suosittelemaan tyyppiin. Hävitä käytetty paristo valmistajan ohjeiden mukaisesti.

To replace the backup battery, follow these steps:

1. If installed, remove the PCI riser assembly.
2. If installed, remove the processor air duct.
3. Locate the battery on the server board.
4. Insert the tip of a small flat bladed screwdriver, or an equivalent, under the tab in the plastic retainer. Gently push down on the screwdriver to lift the battery.
5. Remove the battery from its socket.
6. Dispose of the battery according to local ordinance.
7. Remove the new lithium battery from its package, and, being careful to observe the correct polarity, insert it in the battery socket.

Note: *You will need to run the BIOS Setup to restore the configuration settings to the RTC.*

Removing and Installing the Power Distribution Module

Removing the Power Distribution Module

To remove the server board, follow these steps:

1. Power down the enclosure and remove the power cord(s).
2. Remove the top cover from the enclosure by loosening the captive screw with a Phillips screwdriver on the right-rear of the enclosure.
3. Slide the top cover back and lift it from the enclosure.
4. Remove the processor air duct.
5. Remove the PCI riser assembly.
6. Disconnect power cables, P1, P2, P3 and Front Panel logic cable, from Motherboard as shown below.

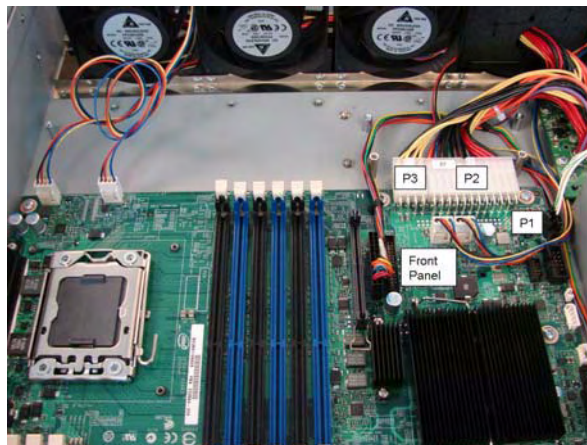

Figure 65. Disconnect the power cables

7. Remove 2 screws from nylon clamps and disconnect power cable “P4” from backplane as shown below.

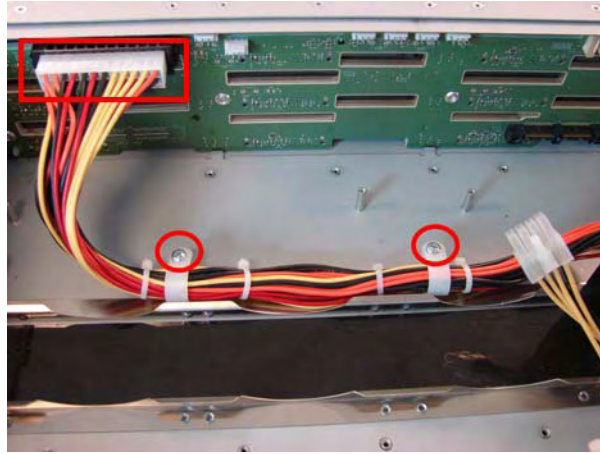

Figure 66. Remove the screws

8. Remove cable chase insert foam from cable chase fan blank and then remove power cable p4 from cable chase fan blank as shown below.

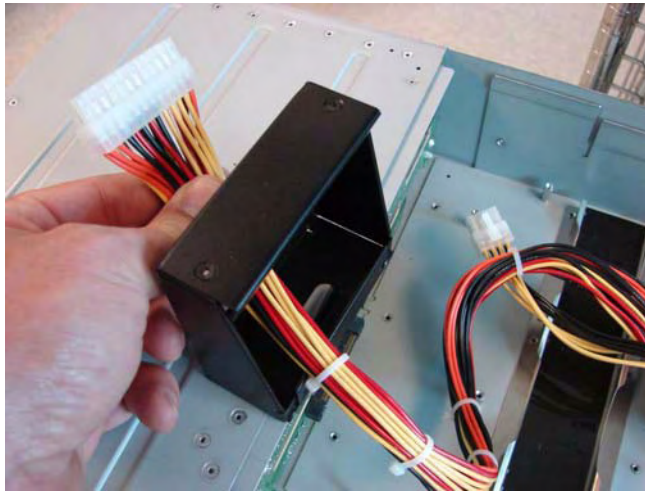

Figure 67. Remove cable chase

9. Remove the four screws from the power distribution module and lift the power distribution module from the server system as shown below.

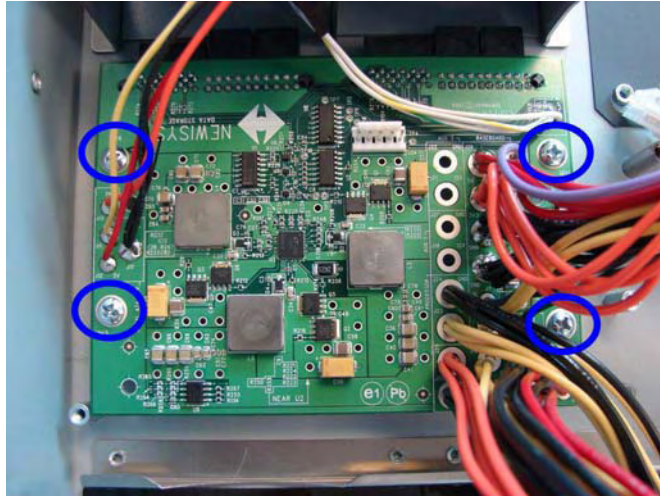

Figure 68. Remove the four screws from the PDB

10. Install the replacement power distribution module.

Installing Power Distribution Module

1. Install power distribution module onto spacers and Install all four screws as shown below.

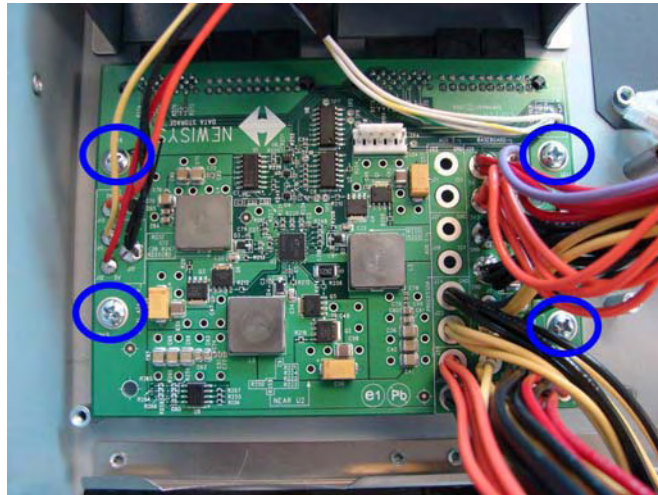

Figure 69. Installing the Power Distribution Module

2. Route cable marked “P4” through the cable chase fan blank as shown below.

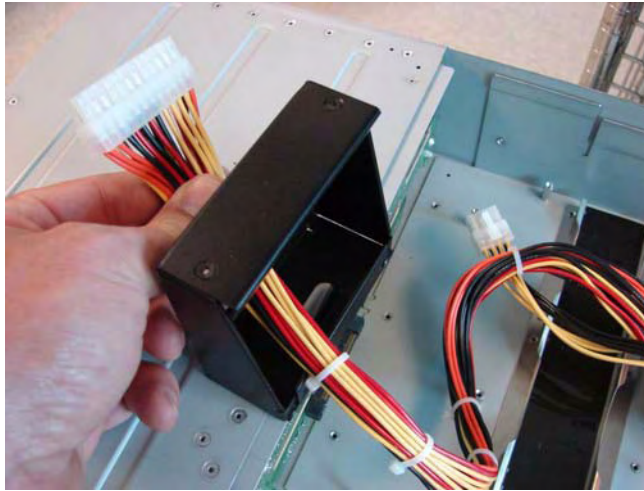

Figure 70. Route cable P4

3. Install 2 nylon clamps onto cable “P4”, flat side up as shown below.

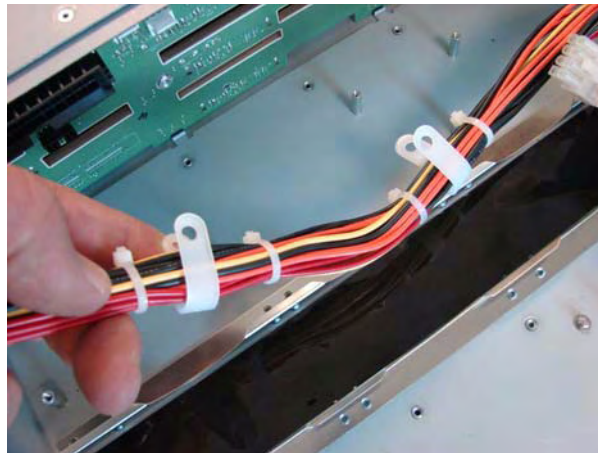

Figure 71. Install the nylon clamps

4. Connect power cable “P4” into backplane and Install 2 screws into nylon clamps and secure to chassis as shown below.

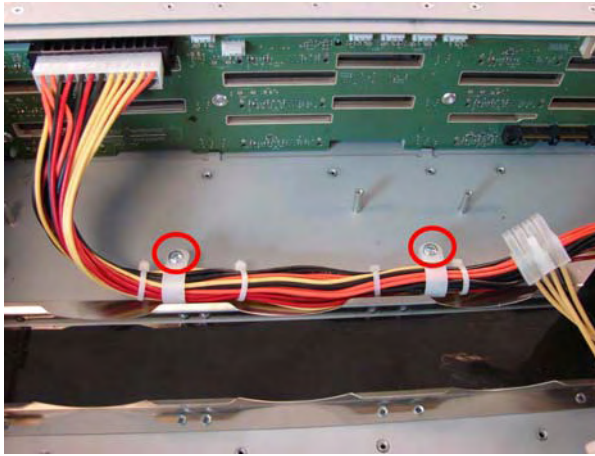

Figure 72. Connecting cable P4 to backplane

5. Insert cable chase insert foam into cable chase fan blank. See picture below for foam orientation.

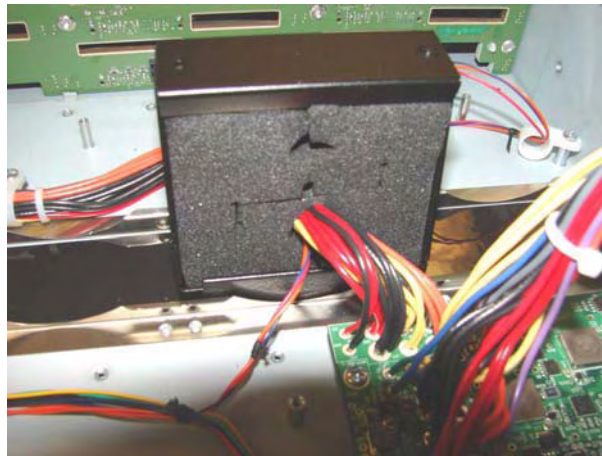

Figure 73. Foam orientation

6. Install power cables, P1, P2, P3 and Front Panel logic cable, into Motherboard as shown below.

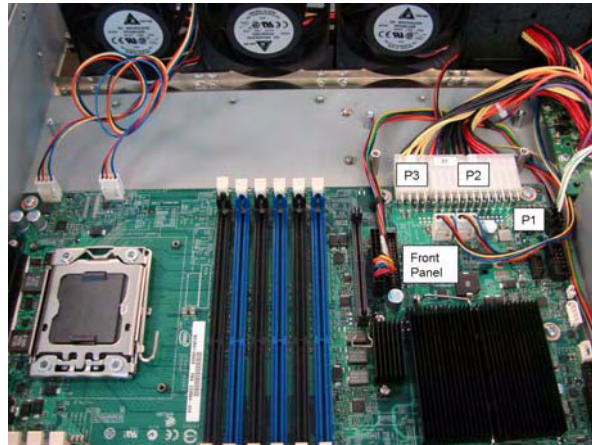

Figure 74. Install the power cables

7. Install the PCI riser assembly.
8. Install the processor air duct.
9. Install the top cover and tighten the captive screw.
10. Install the power cords.

4 Server Utilities

Using the BIOS Setup Utility

This section describes the BIOS Setup utility options, which is used to change server configuration defaults. You can run the BIOS Setup with or without an operating system being present. For information about specific BIOS setup screens, see the *Intel® Server Board S5520UR Technical Product Specification*. For a web link to this document, see [“Additional Information and Software” on page 7](#).

Entering BIOS Setup

To enter the BIOS Setup, press the F2 function key when prompted during boot time. You must ensure that all the jumpers are in the normal operating position.

The following prompt appears during the Power-On Self Test (POST) after POST completes the memory test:

```
Press <F2> to enter SETUP
```

When the BIOS setup is entered, the Main screen is displayed.

If You Cannot Access Setup

If you are not able to access the BIOS Setup, you might need to restore the BIOS default settings. For instructions, see [“Restoring the BIOS Defaults” on page 74](#).

Setup Menus

Each BIOS Setup menu page contains a number of features. Except for those features that are provided only to display automatically configured information, each feature is associated with a value field that contains user-selectable parameters. These parameters can be changed if the user has adequate security rights. If a value cannot be changed for any reason, the feature's value field is inaccessible.

The following table describes the keyboard commands you can use in the BIOS Setup menus.

Table 3. Setup Menu Key Use

Key to Press	Description
<F1>	Pressing <F1> on any menu invokes the general help window.

Table 3. Setup Menu Key Use

Key to Press	Description
Left and right arrows	Select Menu - The left and right arrow keys are used to move between the major menu pages. The keys have no affect if a submenu or pick list is displayed.
Up arrow	Select Item up - The up arrow is used to select the previous value in a menu item's option list, or a value field's pick list. Pressing the <Enter> key activates the selected item.
Down arrow	Select Item down - The down arrow is used to select the next value in a menu item's option list, or a value field's pick list. Pressing the <Enter> key activates the selected item.
<F5> or <->	Change Value - The minus key or the <F5> function key is used to change the value of the current item to the previous value. This key scrolls through the values in the associated pick list without displaying the full list.
<F6> or <+>	Change Value - The plus key or the <F6> function key is used to change the value of the current menu item to the next value. This key scrolls through the values in the associated pick list without displaying the full list. On 106-key Japanese keyboards, the plus key has a different scan code than the plus key on the other keyboard, but it has the same effect.
<Enter>	Execute Command - The <Enter> key is used to activate submenus when the selected feature is a submenu, or to display a pick list if a selected feature has a value field, or to select a sub-field for multi-valued features like time and date. If a pick list is displayed, the <Enter> key selects the currently highlighted item, undoes the pick list, and allows another selection in the parent menu.
<Esc>	Exit - The <Esc> key provides a mechanism for backing out of any field. This key undoes the pressing of the <Enter> key. When the <Esc> key is pressed while editing any field or selecting features of a menu, the parent menu is re-entered. When the <Esc> key is pressed in any submenu, the parent menu is re-entered. When the <Esc> key is pressed in any major menu, the exit confirmation window is displayed and the user is asked whether changes can be discarded.
<F9>	<p>Setup Defaults - Pressing <F9> causes the following to appear:</p> <pre style="text-align: center;"> Setup Confirmation Load default configuration now? [Yes] [No] </pre> <p>If "Yes" is selected and the <Enter> key is pressed, all Setup fields are set to their default values. If "No" is selected and the <Enter> key is pressed, or if the <Esc> key is pressed, you are returned to the screen you were in before <F9> was pressed without affecting any existing field values.</p>

Table 3. Setup Menu Key Use

Key to Press	Description
<F10>	<p>Save and Exit - Pressing <F10> causes the following message to appear:</p> <pre> Setup Confirmation Save Configuration changes and exit now? [Yes] [No]</pre> <p>If "Yes" is selected and the <Enter> key is pressed, all changes are saved and Setup is exited. If "No" is selected and the <Enter> key is pressed, or the <Esc> key is pressed, you are returned to the screen that you were in before <F10> was pressed without affecting any existing values.</p>

Upgrading the BIOS

The upgrade utility allows you to upgrade the BIOS in flash memory. The code and data in the upgrade file include the following:

- On-board system BIOS, including the recovery code, BIOS Setup Utility, and strings.
- On-board video BIOS and other option ROMs for devices embedded on the server board.
- OEM binary area
- Microcode
- A way to change the BIOS language

Preparing for the Upgrade

The following steps explain how to prepare to upgrade the BIOS, including how to record the current BIOS settings and how to obtain the upgrade utility.

Note: *In the unlikely event that a BIOS error occurs during the BIOS update process, a recovery process may need to be followed to return the system to service. See “[Additional Information and Software](#)” on page 7 for a web link to necessary software and instructions.*

Recording the Current BIOS Settings

1. Boot the computer and press <F2> when you see the message:
Press <F2> Key if you want to run SETUP
2. Write down the current settings in the BIOS Setup program.

Note: Do not skip step 2. You will need these settings to configure your server at the end of the procedure.

Obtaining the Upgrade

Download the BIOS image file to a temporary folder on your hard drive. See [“Additional Information and Software” on page 7](#) for a web link to the update software.

Note: Review the instructions and release notes that are provided in the readme file distributed with the BIOS image file before attempting a BIOS upgrade. The release notes contain critical information regarding jumper settings, specific fixes, or other information to complete the upgrade.

Upgrading the BIOS

Follow the instructions in the readme file that came with the BIOS upgrade. When the update completes, remove the bootable media from which you performed the upgrade.

Caution: Do not power down the system during the BIOS update process! The system will reset automatically when the BIOS update process is completed.

Note: You may encounter a CMOS Checksum error or other problem after reboot. If this happens, shut down the system and boot it again. CMOS checksum errors require that you enter Setup, load BIOS defaults, check your settings, save your settings, and exit Setup.

Clearing the Password

If the user or administrator password(s) is lost or forgotten, moving the password clear jumper into the "clear" position clears both passwords. The password clear jumper must be restored to its original position before a new password(s) can be set.

1. Power down the system. Do not unplug the power cord.
2. Open the server system. For instructions on removing the system cover, see [“Removing the System Cover” on page 48](#).
3. Locate the Password Clear jumper block at board position J1E8.
4. Move the jumper from the normal operation position, that is, Password Clear Protect position (covering pins 1 and 2) to the Password Clear Erase position (covering pins 2 and 3).
5. Wait ten seconds.
6. Move the Password Clear jumper back to the Password Clear Protect position (covering pins 1 and 2).
7. Close the server system.
8. Power up the server.

The password is now cleared and can be reset by going into the BIOS setup.

Restoring the BIOS Defaults

If you need to restore the BIOS default settings, the BIOS Default jumper will need to be used.

1. Power down the system; do not disconnect the AC power.
2. Open the server system. For instructions on removing the system cover, see [“Removing the System Cover” on page 48](#).
3. Locate the BIOS Default jumper block at board position J1E7.
4. Move the jumper from the normal operation position (covering pins 1 and 2) to the Set Default position (covering pins 2 and 3).
5. Wait five seconds.
6. Return the BIOS Default jumper to the normal position (covering pins 1 and 2).
7. Close the server system.
8. Power up the system.

The BIOS defaults settings are now restored and can be reset by going into the BIOS setup.

Appendix A: Drive Installation in the Drive Carrier

Introduction

The Intel® Server System SR2612UR universal drive carrier is either used for mounting drives into an enclosure or is used with a blank insert (no drive installed) to maintain proper cooling. This appendix covers the installation of a disk drive in the universal drive carrier.

Caution: *Acclimate new disk drives to room temperature for at least two hours prior to use.*

Caution: *Be sure to take antistatic precautions when handling disk drives. Use an anti-static wrist strap with grounding wire as a minimum precaution.*

Installing a Disk Drive in a Universal Drive Carrier

Perform the following steps to install a disk drive into the universal drive carrier.

1. Remove the four (4) screws holding the plastic spacer per the following illustration. If you are installing a replacement drive, remove the original drive from the carrier.

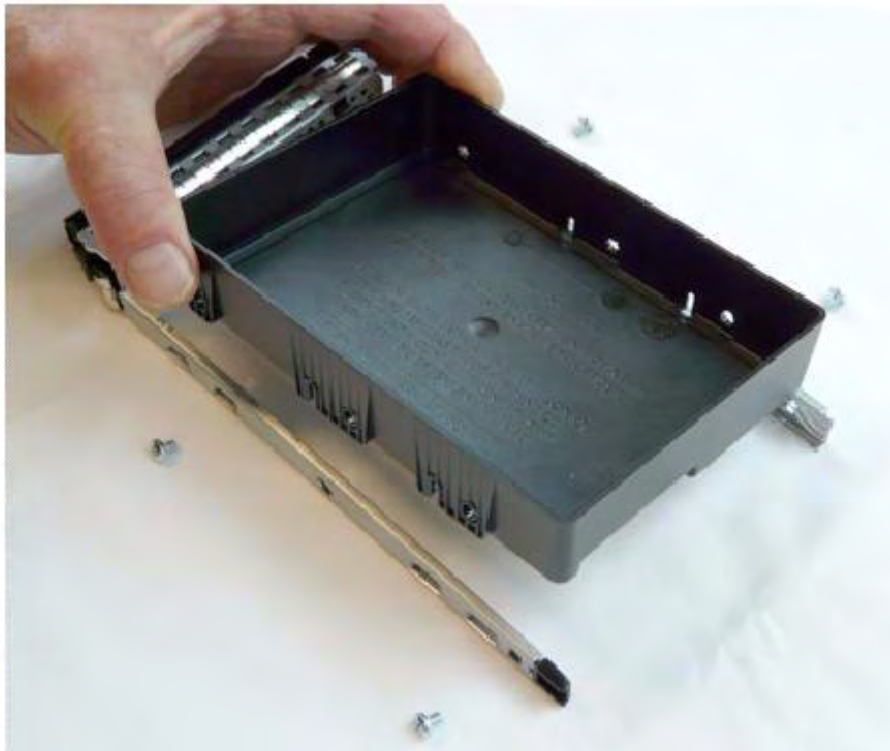

Figure 75. Installing a Disk Drive in a Universal Carrier

2. Do not discard the screws as you will use them to install the disk drive.
3. You can discard or retain the plastic spacer depending on whether you will use blanks at a later time in the enclosure.
4. Position the disk drive with the connector towards the rear of the carrier and the disk drive label on top per the illustration below. There are two sets of mounting holes on the carrier. Use the four holes that position the connector farthest back on the carrier. This will ensure the drive will make good connection with the enclosure midplane.



Figure 76. Installing the Four Screws into the Drive Carrier

5. Insert and hand tighten the four (4) 6 x 32 x .25-inch screws. Do not overtighten the screws as this may strip the threads on either the screw or the disk drive.
6. You can now install the drive into the enclosure.

The universal carrier also has the ability to accommodate an interposer multiplexer module (MUX) that you can install to accommodate dual-port capability with SATA drives (SAS drives are already dual ported and do not require a mux). This feature is not supported on the storage application array, but is used on other enclosures.

Installing a Blank Insert in a Universal Drive Carrier

A drive blank insert (plastic spacer) is used on a drive carrier when no disk drive is installed. The plastic insert is required to maintain structural integrity of the universal carrier when used as a blank drive in the enclosure. An enclosure is required to have either a disk drive or blank in every drive slot to maintain proper cooling.

1. To install the blank insert in the universal drive carrier, position the plastic insert as shown in the following figure with the connector indentation at the “rear” of the universal drive carrier.

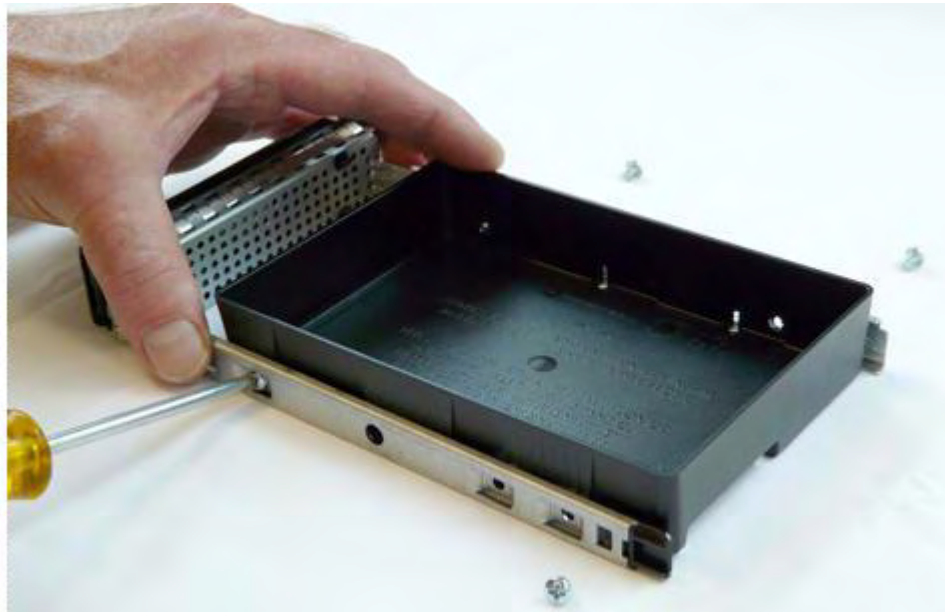

Figure 77. Orienting the Plastic Insert with the Drive Carrier

2. Carefully install the four (4) 6 x 32 x .25-inch screws supplied with the carrier. Do not overtighten.

Appendix B: Intel® Server Issue Report Form

Issue Report Form (Rev 3.6)

Note: Filling out this form completely is required for any escalation.

=====

Customer Contact Information:

Customer Support Case #:

=====

Intel® Server Board or System:

(Example: S5000PSL or SR6850HW4)

=====

Server Chassis:

(Example SC5400. If third-party chassis used, indicate make and model.)

=====

Baseboard Information: (some information maybe found by accessing BIOS & going through the Server Management menu -> System Information)

Baseboard PBA/TA/AA # (Example: 123456-789):

- can be found on the white sticker label on the baseboard

System BIOS Version:

Intel® Remote Management Module Firmware Version (if applicable):

Intel® Management Module BMC Revision (if applicable):

BMC/mBMC Version:

FRU/SDR Version:

HSC Version:

Has the latest BIOS been tried? (Yes/No):

Has the latest BMC/mBMC been tried? (Yes/No):

Has the latest IMM BMC been tried? (Yes/No):

Has the latest RMM Firmware been tried? (Yes/No):

Has the latest FRU/SDR been tried? (Yes/No):

Has the latest HSC been tried? (Yes/No):

=====

Processor information:

	Type	Speed	sSpec	Thermal Solution
Processor 1				
Processor 2				
Processor 3				
Processor 4				

Thermal solution (Heatsink) examples:

(1U, Passive w/air ducting, Active w/fan, etc.)

=====

Memory:

Manufacturer	Part Number	DRAM Part Number	On Intel tested list?

Add-in adapters (Example: NICs, Management Adapters, Serial Expansion Cards, PCI-Express* Adapters, RAID Controllers, SCSI Controllers, etc.):

Type	Slot	Manufacturer	Model	Firmware

Third party hardware Example KVM, Chassis, and so forth):

Description/Use	Manufacturer	Model	Firmware

Storage Devices (Example: SCSI, SATA, SAS, USB, Tape, etc.):

Manufacturer	Model	Type	Size	Firmware	In Hot-Swap Bay?

=====

Operating System Information (Example: RedHat* Enterprise Linux, Microsoft* Windows* Server 2003, Service pack 1, OEM CD):

Manufacturer:

Version:

Language version (English, Arabic, Chinese (Simplified)):

Service Pack Level or Kernel Revision:

Distribution (OEM/Retail):

=====

Intel® RAID Controller: (Example SRCU42E)

RAID controller part number (PBA number):

RAID controller firmware version:

Has the latest RAID firmware been tried? (Yes/No):

RAID driver version:

Has the latest RAID driver been tried? (Yes/No):

RAID volumes configuration (disks & RAID level):

RAID volume use (Boot device/Data Volume):

Is BBU (Battery Backup Unit) installed? (Yes/No):

BBU part number:

Detailed description of issue:

Troubleshooting tried:

Steps to replicate the issue:

=====
Issue impact statements:

Do you have any potential Intel system, or component purchases that this issue is holding up? If yes, please provide a brief description below.

Do you have systems already purchased that are not being delivered to your customers because of this issue? If yes, please provide a brief description below.

Have you returned systems or components to your place of purchase because of this issue? If yes, please provide a brief description below.

*All other brands and names are property of their respective owners.

Appendix C: LED Decoder

Appliance Status

On the right front side of the Intel® Server System SR2612UR are four LEDs which indicate the status of the appliance.

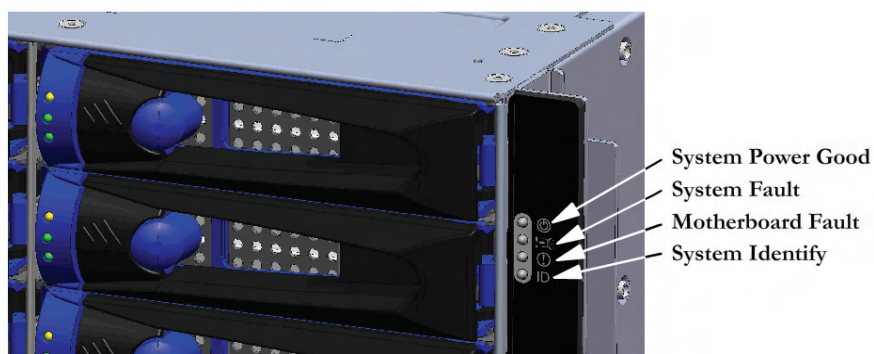

Figure 78. LED Statuses

The following table describes what each LED indicates:

When a failure occurs within the system, the System Fault LED illuminates.

Table 4. LED Decoder

LED	Descriptor	Color	Description
1	System power good	Green	System power OK
2	System fault	Amber	System fault detected
3	server board fault	Amber	server board fault detected
4	System identify	Blue	Enclosure ID

LED Status Board

The LED board is located at the rear of the enclosure above the power supply modules. The following image shows the LED board:

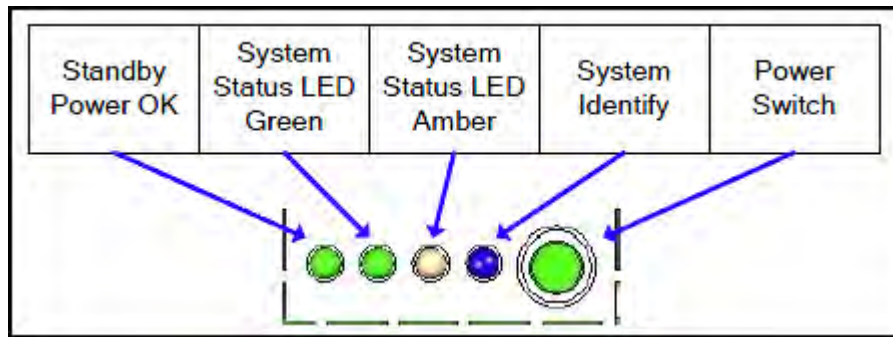

Figure 79. LED Board

The following table describes the LED Board LEDs.

Table 5. LED Board LEDs Descriptions

LED	Color	Description
Standby Power OK	Green	Indicates the power is okay
System Status LED Green	Green	
System Status LED Amber	Amber	
System Identify	Blue	Enclosure ID

Monitoring the Disk Drives

Each populated disk drive carrier has three LEDs that indicate the status of the disk drive, as described in the following table.



Figure 80. Disk Drive LEDs

Table 6. LED Status for the Disk Drive

LED	Condition	Color
1	Not Used	

Table 6. LED Status for the Disk Drive

LED	Condition	Color
2	Disk Status	Green/Amber
3	Disk Activity	Green

Table 7. LED Status (SAS/SATA) for the Disk Drive

LED	Flash Pattern	Indication
2	Repeating cycle of Green for 250 milliseconds/ Off for 250 milliseconds	Identify
	Amber On constantly	Fault
	Repeating cycle of Amber for 250 milliseconds/ Off for 250 milliseconds	Predicted Fail
	Repeating cycle of Amber for 500 milliseconds/ Green for 500 milliseconds	Reserved Device
	Repeating cycle of Amber for 500 milliseconds/ Green for 500 milliseconds (Green on constantly with Midplane firmware 105 or later)	Hot Spare
	Repeating cycle of Amber for 500 milliseconds/ Green for 500 milliseconds	Consistency Check
	Repeating cycle of Amber for 500 milliseconds/ Green for 500 milliseconds	In Critical Array
	Repeating cycle of Amber for 500 milliseconds/ Green for 500 milliseconds	In Failed Array
	Repeating cycle of Green for 750 milliseconds/ Off for 250 milliseconds	Rebuild
	Repeating cycle of Green for 500 milliseconds/ Off for 500 milliseconds	Prepare for Operation
	Repeating cycle of Green for 500 milliseconds/ Off for 500 milliseconds	Prepare for Removal

Audible Alarm

There is an audible alarm for fault conditions on both the RAID controller and the dual power supplies. For RAID controller error conditions, please refer to the manufacturer's documentation. The power supply alarm sounds if a power supply has failed or is not properly seated.

Note: You can also use the LSI MegaRaid software supplied with the RAID controller to manage and monitor the system configuration. LSI MegaRaid is a trademark of LSI Corporation.

Appendix D: Getting Help

If you encounter an issue with your server system, follow these steps to obtain support:

1. Visit the following Intel support web page:
<http://www.intel.com/support/motherboards/server/>
This web page provides 24x7 support when you need it to get the latest and most complete technical support information on all Intel Enterprise Server and Storage Platforms. Information available at the support site includes:
 - Latest BIOS, firmware, drivers and utilities
 - Product documentation, installation and quick start guides
 - Full product specifications, technical advisories and errata
 - Compatibility documentation for memory, hardware add-in cards, chassis support matrix and operating systems
 - Server and chassis accessory parts list for ordering upgrades or spare parts
 - A searchable knowledgebase to search for product information throughout the support site
2. If you are still unable to obtain a solution to your issue, send an email to Intel's technical support center using the online form available at <http://supportmail.intel.com/scripts-emf/welcome.aspx>
3. Lastly, you can contact an Intel support representative using one of the support phone numbers available at <http://support.intel.com/support/9089.htm> (charges may apply). Intel customer support suggests filling out the issue report form available at “[Intel® Server Issue Report Form](#)” on page 79 to better service the issue.
Intel also offers Channel Program members around-the-clock 24x7 technical phone support on Intel® server boards, server chassis, server RAID controller cards, and Intel® Server Management at <http://www.intel.com/reseller/>.

Note: You will need to log in to the Reseller site to obtain the 24x7 number.

Warranty Information

To obtain warranty information, visit the following Intel web site:

<http://support.intel.com/support/motherboards/server/sb/CS-010807.htm>

Appendix E: Regulatory and Certification Information

Warning: *To ensure regulatory compliance, you must adhere to the assembly instructions in this guide to ensure and maintain compliance with existing product certifications and approvals. Use only the described, regulated components specified in this guide. Use of other products/components will void the UL listing and other regulatory approvals of the product and will most likely result in noncompliance with product regulations in the region(s) in which the product is sold.*

To help ensure EMC compliance with your local regional rules and regulations, before computer integration, make sure that the server system, power supply, and other modules have passed EMC testing using a server board with a microprocessor from the same family (or higher) and operating at the same (or higher) speed as the microprocessor used on this server board. The final configuration of your end system product may require additional EMC compliance testing. For more information, please contact your local Intel representative.

This is an FCC Class A device. Integration of it into a Class B system does not result in a Class B device.

Product Regulatory Compliance

This server chassis product, when correctly integrated per this guide, complies with the following safety and electromagnetic compatibility (EMC) regulations.

Intended Application - This product was evaluated as Information Technology Equipment (ITE), which may be installed in offices, schools, computer rooms, and similar commercial type locations. The suitability of this product for other product categories and environments (such as: medical, industrial, telecommunications, NEBS, residential, alarm systems, test equipment, etc.), other than an ITE application, may require further evaluation.

Note: *The use and/or integration of telecommunication devices such as modems and/or wireless devices have not been planned for with respect to these systems. If there is any change of plan to use such devices, then telecommunication type certifications will require additional planning. If NEBS compliance is required for system level products, additional certification planning and design will be required.*

Product Safety Compliance

- CSA 60950-1 Certification (Canada)
- UL 60950-1 Listing (USA)

- IEC60950-1 (International)
- CB Certificate & Report, IEC60950 (report to include all country national deviations)
- GS Certification (Germany – EN60950-1)
- GOST R 50377-92 - Certification (Russia)
- Ukraine Certification (Ukraine)
- CE Declaration to EU Low Voltage Directive 2006/95/EC (Europe – EN60950-1)
- IRAM Certification (Argentina)
- BSMI RPC Certification (Taiwan)

Product EMC Compliance - Class A Compliance

- FCC – Part 15 Emissions (USA) Verification
- ICES-003 – (Canada)
- CISPR 22 – Emissions (International)
- EN55022 - Emissions (Europe)
- EN55024 - Immunity (Europe)
- EN61000-3-2 - Harmonics (Europe)
- EN61000-3-3 - Voltage Flicker (Europe)
- CE – EMC Directive 2004/108/EC (Europe)
- VCCI Emissions (Japan)
- AS/NZS CISPR 22 Emissions (Australia / New Zealand)
- BSMI CNS13438 Emissions (Taiwan)
- GOST R 29216-91 Emissions (Russia)
- GOST R 50628-95 Immunity (Russia)
- Ukraine Certification (Ukraine)
- KCC MIC Notice No. 1997-41 (EMC) & 1997-42 (EMI) (Korea)

Product Ecology Compliance

Intel has a system in place to restrict the use of banned substances in accordance with world wide regulatory requirements. A Material Declaration Data Sheet is available for Intel products. For more reference on material restrictions and compliance you can view Intel's Environmental Product Content Specification at <http://supplier.intel.com/ehs/environmental.htm>.

- Europe - European Directive 2002/95/EC - Restriction of Hazardous Substances (RoHS)
Threshold limits and banned substances are noted below.
Quantity limit of 0.1% by mass (1000 PPM) for:
Lead, Mercury, Hexavalent Chromium, Polybrominated Biphenyls Diphenyl Ethers (PBB/PBDE)
Quantity limit of 0.01% by mass (100 PPM) for:
Cadmium
- CA. Lithium Perchlorate insert
Perchlorate Material – Special handling may apply. See www.dtsc.ca.gov/hazardouswaste/perchlorate
This notice is required by California Code of Regulations, Title 22, Division 4.5, Chapter 33: Best Management Practices for Perchlorate Materials. This product / part includes a battery which contains Perchlorate material.
- China RoHS (MII Measure 39)
Product marked with the Environmental Friendly Usage Period (EFUP) label of 20yrs, substance table in Simplified Chinese either placed with the product documentation or separate insert.
- WEEE Directive (2002/96/EC)
- EU Packaging Directive (94/62/EC)
- All plastic parts that weigh >25gm shall be marked with the ISO11469 requirements for recycling. Example >PC/ABS<

Certifications / Registrations / Declarations

- NRTL Certification (US/Canada)
- CB Certification (International)
- CE Declaration of Conformity (CENELEC Europe)
- FCC/ICES-003 Class A Attestation (USA/Canada)
- VCCI Certification (Japan)
- C-Tick Declaration of Conformity (Australia)
- MED Declaration of Conformity (New Zealand)
- BSMI Certification (Taiwan)
- GOST R Certification / Certification (Russia)

- KCC Certification (Korea)
- IRAM Certification (Argentina)
- Ecology Declaration (International)
- China RoHS Environmental Friendly Use Period
- Packaging & Product Recycling Marks

Product Regulatory Compliance Markings

This Intel Server Chassis product is provided with the following regulatory and safety markings. In the event there is no room for a marking(s) on the chassis, the information is provided here in this guide

Table 8. Product Regulatory Compliance Markings





Regulatory Compliance	Country	Marking
cETLus Listing Marks	USA/Canada	
GS Mark	Germany	
CE Mark	Europe	
IRAM Mark	Argentina	
Ctick Mark	Australia / NZ	 N232
Country of Origin Mark		Made in China

Table 8. Product Regulatory Compliance Markings



Regulatory Compliance	Country	Marking
FCC Marking (Class A)	USA	This device complies with Part 15 of the FCC Rules. Operation of this device is subject to the following two conditions: (1) This device may not cause harmful interference, and (2) This device must accept any interference received, including interference that may cause undesired operation. Manufactured by Intel Corporation
EMC Marking (Class A)	Canada	CANADA ICES-003 CLASS A
VCCI Marking (Class A)	Japan	この装置は、クラス A 情報技術装置です。この装置を家庭環境で使用すると電波妨害を引き起こすことがあります。この場合には使用者が適切な対策を講ずるよう要求されることがあります。VCCI-A
BSMI Certification Number & Class A Warning	Taiwan	 <div style="border: 1px solid black; padding: 5px; margin-top: 10px;"> <p>警告使用者： 這是甲類的資訊產品，在居住的環境中使用時，可能會造成射頻干擾，在這種情況下，使用者會被要求採取某些適當的對策</p> </div>
GOST R Marking	Russia	 <p>MO04</p>
KCC Mark (Korean Communications Commission)	Korea	 <p>인증번호 : CPU-SR2612 (A)</p>

Table 8. Product Regulatory Compliance Markings







Regulatory Compliance	Country	Marking
Waste of Electronic and Electrical Equipment Recycling Mark	Europe	
China Restriction of Hazardous Substance Environmental Friendly Use Period Mark	China	
China Recycling Mark	China	
Recycling Marks	International	
Battery Perchlorate Warning Information	California	<p>Perchlorate Material - Special handling may apply. See www.dtsc.ca.gov/hazardouswaste/perchlorate</p> <p>This notice is required by California Code of Regulations, Title 22, Division 4.5, and Chapter 33: Best Management Practices for Perchlorate Materials. This product may include a battery which contains Perchlorate material.</p>

Table 8. Product Regulatory Compliance Markings

Regulatory Compliance	Country	Marking
Safety	Multiple Power Cord Marking	 <p>This unit has more than one power supply cord. To reduce the risk of electrical shock, disconnect (2) two power supply cords before servicing.</p> <p>Simplified Chinese:</p> <p>注意： 本設備包括多條電源系統電纜。為避免遭受電擊，在進行維修之前應斷開兩（2）條電源系統電纜。</p> <p>Traditional Chinese:</p> <p>注意： 本設備包括多條電源系統電纜。為避免遭受電擊，在進行維修之前應斷開兩（2）條電源系統電纜。</p> <p>German:</p> <p>Dieses Geräte hat mehr als ein Stromkabel. Um eine Gefahr des elektrischen Schlages zu verringern trennen sie beide (2) Stromkabeln bevor Instandhaltung.</p>
Nordic Ground Marking	Connection to Proper Ground Outlet	<p>"WARNING:"</p> <p>"Apparaten skall anslutas till jordat uttag, när den ansluts till ett nätverk."</p> <p>"Laite on liitettävä suojamaadoituskoskettimilla varustettuun pistorasiaan."</p> <p>"Connect only to a properly earth grounded outlet."</p>
Safety	Stand-by power	

Rack Mount Installation Guidelines

Anchor the equipment rack: The equipment rack must be anchored to an unmovable support to prevent it from falling over when one or more servers are extended in front of the rack on slides. You must also consider the weight of any other device installed in the rack. A crush hazard exists should the rack tilt forward which could cause serious injury.

Temperature: The temperature, in which the server operates when installed in an equipment rack, must not go below 5 °C (41 °F) or rise above 40 °C (104 °F). Extreme fluctuations in temperature can cause a variety of problems in your server.

Ventilation: The equipment rack must provide sufficient airflow to the front of the server to maintain proper cooling. The rack must also include ventilation sufficient to exhaust a maximum of 1023 BTUs (British Thermal Units) per hour for the server. The rack selected and the ventilation provided must be suitable to the environment in which the server will be used.

If AC power supplies are installed:

Mains AC power disconnection: The AC power cord(s) is considered the mains disconnect for the server and must be readily accessible when installed. If the individual server power cord(s) will not be readily accessible for disconnection then you are responsible for installing an AC power disconnect for the entire rack unit. This main disconnect must be readily accessible, and it must be labeled as controlling power to the entire rack, not just to the server(s).

Grounding the rack installation: To avoid the potential for an electrical shock hazard, you must include a third wire safety ground conductor with the rack installation. If the server power cord is plugged into an AC outlet that is part of the rack, then you must provide proper grounding for the rack itself. If the server power cord is plugged into a wall AC outlet, the safety ground conductor in the power cord provides proper grounding only for the server. You must provide additional, proper grounding for the rack and other devices installed in it.

Overcurrent protection: The server is designed for an AC line voltage source with up to 20 amperes of overcurrent protection per cord feed. If the power system for the equipment rack is installed on a branch circuit with more than 20 amperes of protection, you must provide supplemental protection for the server.

If DC power supplies are installed:

Connection with a DC (Direct Current) source should only be performed by trained service personnel. The server with DC input is to be installed in a Restricted Access Location in accordance with articles 110-16, 110-17, and 110-18 of the National Electric Code, ANSI/NFPA 70. The DC source must be electrically isolated by double or reinforced insulation from any hazardous AC source.

Main DC power disconnect: You are responsible for installing a properly rated DC power disconnect for the server system. This mains disconnect must be readily accessible, and it must be labeled as controlling power to the server. The circuit breaker of a centralized DC power system may be used as a disconnect device when easily accessible and should be rated no more than 10 amps.

Grounding the server: To avoid the potential for an electrical shock hazard, you must reliably connect an earth grounding conductor to the server. The earth grounding conductor must be a minimum 18AWG connected to the earth ground stud(s) on the rear of the server. The safety ground conductor should be connected to the chassis stud with a Listed closed two-hole crimp terminal having 5/8 inch pitch. The nuts on the chassis earth ground studs should be installed with a 10 in/lbs torque. The safety ground conductor provides proper grounding only for the server. You must provide additional, proper grounding for the rack and other devices installed in it.

Overcurrent protection: Overcurrent protection circuit breakers must be provided as part of each host equipment rack and must be incorporated in the field wiring between the DC source and the server. The branch circuit protection shall be rated minimum 75Vdc, 10 A maximum per feed pair. If the DC power system for the equipment rack is installed with more than 10 amperes of protection, you must provide supplemental protection for the server.

Power Cord Usage Guidelines

Warning: Do not attempt to modify or use an AC power cord set that is not the exact type required. You must use a power cord set that meets the following criteria:

- *Rating: In the U.S. and Canada, cords must be UL (Underwriters Laboratories, Inc.) Listed/CSA (Canadian Standards Organization) Certified type SJT, 18-3 AWG (American Wire Gauge). Outside of the U.S. and Canada, cords must be flexible harmonized (<HAR>) or VDE (Verband Deutscher Electrotechniker, German Institute of Electrical Engineers) certified cord with 3 x 0.75 mm conductors rated 250 VAC (Volts Alternating Current).*
- *Connector, wall outlet end: Cords must be terminated in grounding-type male plug designed for use in your region. The connector must have certification marks showing certification by an agency acceptable in your region and for U.S. must be Listed and rated 125% of overall current rating of the server.*
- *Connector, server end: The connectors that plug into the AC receptacle on the server must be an approved IEC (International Electrotechnical Commission) 320, sheet C13, type female connector.*
- *Cord length and flexibility: Cords must be less than 4.5 meters (14.76 feet) long.*

Electromagnetic Compatibility Notices

FCC Verification Statement (USA)

This device complies with Part 15 of the FCC Rules. Operation is subject to the following two conditions: (1) this device may not cause harmful interference, and (2) this device must accept any interference received, including interference that may cause undesired operation.

For questions related to the EMC performance of this product, contact:

Intel Corporation
5200 N.E. Elam Young Parkway
Hillsboro, OR 97124-6497
1-800-628-8686

This equipment has been tested and found to comply with the limits for a Class A digital device, pursuant to Part 15 of the FCC Rules. These limits are designed to provide reasonable protection against harmful interference in a residential installation. This equipment generates, uses, and can radiate radio frequency energy and, if not installed and used in accordance with the instructions, may cause harmful interference to radio communications. However, there is no guarantee that interference will not occur in a particular installation. If this equipment does cause harmful interference to radio or television reception, which can be determined by turning the equipment off and on, the user is encouraged to try to correct the interference by one or more of the following measures:

- Reorient or relocate the receiving antenna.
- Increase the separation between the equipment and the receiver.
- Connect the equipment to an outlet on a circuit other than the one to which the receiver is connected.
- Consult the dealer or an experienced radio/TV technician for help.

Any changes or modifications not expressly approved by the grantee of this device could void the user's authority to operate the equipment. The customer is responsible for ensuring compliance of the modified product.

Only peripherals (computer input/output devices, terminals, printers, etc.) that comply with FCC Class A or B limits may be attached to this computer product. Operation with noncompliant peripherals is likely to result in interference to radio and TV reception.

All cables used to connect to peripherals must be shielded and grounded. Operation with cables, connected to peripherals that are not shielded and grounded may result in interference to radio and TV reception.

ICES-003 (Canada)

Cet appareil numérique respecte les limites bruits radioélectriques applicables aux appareils numériques de Classe A prescrites dans la norme sur le matériel brouilleur: "Appareils Numériques", NMB-003 édictée par le Ministre Canadien des Communications.

English translation of the notice above:

This digital apparatus does not exceed the Class A limits for radio noise emissions from digital apparatus set out in the interference-causing equipment standard entitled: "Digital Apparatus," ICES-003 of the Canadian Department of Communications.

CE Declaration of Conformity (Europe)

This product has been tested in accordance to, and complies with the Low Voltage Directive (73/23/EEC) and EMC Directive (89/336/EEC). The product has been marked with the CE Mark to illustrate its compliance.

VCCI (Japan)

この装置は、情報処理装置等電波障害自主規制協議会（VCCI）の基準に基づくクラスB情報技術装置です。この装置は、家庭環境で使用することを目的としていますが、この装置がラジオやテレビジョン受信機に近接して使用されると、受信障害を引き起こすことがあります。
取扱説明書に従って正しい取り扱いをして下さい。

English translation of the preceding notice:

This is a Class A product based on the standard of the Voluntary Control Council for Interference (VCCI) from Information Technology Equipment. If this is used near a radio or television receiver in a domestic environment, it may cause radio interference. Install and use the equipment according to the instruction manual.

BSMI (Taiwan)

警告使用者：
這是甲類的資訊產品，在居住的環境中使用時，可能會造成射頻干擾，在這種情況下，使用者會被要求採取某些適當的對策

The BSMI Certification Marking and EMC warning is located on the outside rear area of the product.

KCC (Korea)

Following is the KCC certification information for Korea.

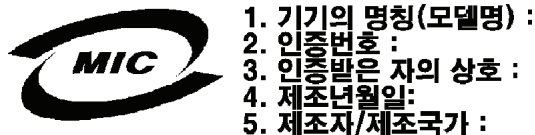

English translation of the notice above:

1. Type of Equipment (Model Name): On License and Product
2. Certification No.: On RRL certificate. Obtain certificate from local Intel representative
3. Name of Certification Recipient: Intel Corporation
4. Date of Manufacturer: Refer to date code on product
5. Manufacturer/Nation: Intel Corporation/Refer to country of origin marked on product

Regulated Specified Components

To maintain the UL listing and compliance to other regulatory certifications and/or declarations, the following regulated components must be used and conditions adhered to. Interchanging or use of other components will void the UL listing and other product certifications and approvals.





Updated product information for configurations can be found on the Intel Server Builder Web site at the following URL: <http://channel.intel.com/go/serverbuilder>



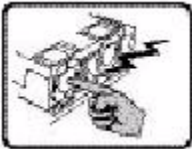

If you do not have access to Intel's Web address, please contact your local Intel representative.

- **Server Chassis:** (base chassis is provided with power supply and fans) - NRTL listed.
- **Server board:** you must use an Intel server board - UL recognized.
- **Add-in boards:** must have a printed wiring board flammability rating of minimum UL94V-1. Add-in boards containing external power connectors and/or lithium batteries must be UL recognized or UL listed. Any add-in board containing modem telecommunication circuitry must be UL listed. In addition, the modem must have the appropriate telecommunications, safety, and EMC approvals for the region in which it is sold.
- **Peripheral Storage Devices:** must be UL recognized or UL listed accessory and TUV or VDE Certificationd. Maximum power rating of any one device is 19 watts. Total server configuration is not to exceed the maximum loading conditions of the power supply.

Appendix F: Installation/Assembly Safety Instructions

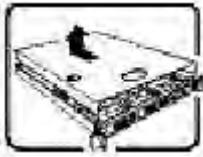
English

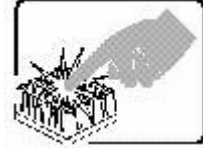
	<p>The power supply in this product contains no user-serviceable parts. Refer servicing only to qualified personnel.</p>
	<p>Do not attempt to modify or use the supplied AC power cord if it is not the exact type required. A product with more than one power supply will have a separate AC power cord for each supply.</p>
	<p>The power button on the system does not turn off system AC power. To remove AC power from the system, you must unplug each AC power cord from the wall outlet or power supply.</p> <p>The power cord(s) is considered the disconnect device to the main (AC) power. The socket outlet that the system plugs into shall be installed near the equipment and shall be easily accessible.</p>
	<p>SAFETY STEPS: Whenever you remove the chassis covers to access the inside of the system, follow these steps:</p> <ol style="list-style-type: none">1. Turn off all peripheral devices connected to the system.2. Turn off the system by pressing the power button.3. Unplug all AC power cords from the system or from wall outlets.4. Label and disconnect all cables connected to I/O connectors or ports on the back of the system.5. Provide some electrostatic discharge (ESD) protection by wearing an antistatic wrist strap attached to chassis ground of the system-any unpainted metal surface-when handling components.6. Do not operate the system with the chassis covers removed.

	<p>After you have completed the six SAFETY steps above, you can remove the system covers. To do this:</p> <ol style="list-style-type: none"> 1. Unlock and remove the padlock from the back of the system if a padlock has been installed. 2. Remove and save all screws from the covers. 3. Remove the cover(s).
	<p>For proper cooling and airflow, always reinstall the chassis covers before turning on the system. Operating the system without the covers in place can damage system parts. To install the covers:</p> <ol style="list-style-type: none"> 1. Check first to make sure you have not left loose tools or parts inside the system. 2. Check that cables, add-in boards, and other components are properly installed. 3. Attach the covers to the chassis with the screws removed earlier, and tighten them firmly. 4. Insert and lock the padlock to the system to prevent unauthorized access inside the system. 5. Connect all external cables and the AC power cord(s) to the system.
	<p>A microprocessor and heat sink may be hot if the system has been running. Also, there may be sharp pins and edges on some board and chassis parts. Contact should be made with care. Consider wearing protective gloves.</p>
	<p>Danger of explosion if the battery is incorrectly replaced. Replace only with the same or equivalent type recommended by the equipment manufacturer. Dispose of used batteries according to manufacturer's instructions.</p>

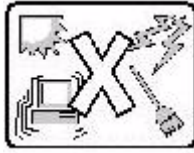

The system is designed to operate in a typical office environment. Choose a site that is:

- Clean and free of airborne particles (other than normal room dust).
- Well ventilated and away from sources of heat including direct sunlight.
- Away from sources of vibration or physical shock.
- Isolated from strong electromagnetic fields produced by electrical devices.
- In regions that are susceptible to electrical storms, we recommend you plug your system into a surge suppressor and disconnect telecommunication lines to your modem during an electrical storm.
- Provided with a properly grounded wall outlet.
- Provided with sufficient space to access the power supply cord(s), because they serve as the product's main power disconnect.

Deutsch

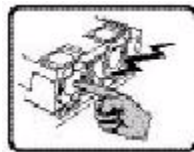

Benutzer können am Netzgerät dieses Produkts keine Reparaturen vornehmen. Das Produkt enthält möglicherweise mehrere Netzgeräte. Wartungsarbeiten müssen von qualifizierten Technikern ausgeführt werden.



Versuchen Sie nicht, das mitgelieferte Netzkabel zu ändern oder zu verwenden, wenn es sich nicht genau um den erforderlichen Typ handelt. Ein Produkt mit mehreren Netzgeräten hat für jedes Netzgerät ein eigenes Netzkabel.



Der Wechselstrom des Systems wird durch den Ein-/Aus-Schalter für Gleichstrom nicht ausgeschaltet. Ziehen Sie jedes Wechselstrom-Netzkabel aus der Steckdose bzw. dem Netzgerät, um den Stromanschluß des Systems zu unterbrechen.



SICHERHEISSMASSNAHMEN: Immer wenn Sie die Gehäuseabdeckung abnehmen um an das Systeminnere zu gelangen, sollten Sie folgende Schritte beachten:

1. Schalten Sie alle an Ihr System angeschlossenen Peripheriegeräte aus.
2. Schalten Sie das System mit dem Hauptschalter aus.
3. Ziehen Sie den Stromanschlußstecker Ihres Systems aus der Steckdose.
4. Auf der Rückseite des Systems beschriften und ziehen Sie alle Anschlußkabel von den I/O Anschlüssen oder Ports ab.
5. Tragen Sie ein geerdetes Antistatik Gelenkband, um elektrostatische Ladungen (ESD) über blanke Metallstellen bei der Handhabung der Komponenten zu vermeiden.
6. Schalten Sie das System niemals ohne ordnungsgemäß montiertes Gehäuse ein.

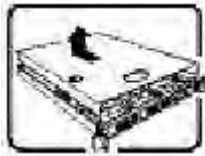

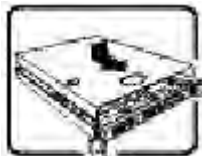

SICHERHEISSMASSNAHMEN: Immer wenn Sie die Gehäuseabdeckung abnehmen um an das Systeminnere zu gelangen, sollten Sie folgende Schritte beachten:

1. Schalten Sie alle an Ihr System angeschlossenen Peripheriegeräte aus.
2. Schalten Sie das System mit dem Hauptschalter aus.
3. Ziehen Sie den Stromanschlußstecker Ihres Systems aus der Steckdose.
4. Auf der Rückseite des Systems beschriften und ziehen Sie alle Anschlußkabel von den I/O Anschlüssen oder Ports ab.
5. Tragen Sie ein geerdetes Antistatik Gelenkband, um elektrostatische Ladungen (ESD) über blanke Metallstellen bei der Handhabung der Komponenten zu vermeiden.
6. Schalten Sie das System niemals ohne ordnungsgemäß montiertes Gehäuse ein.



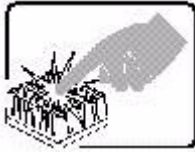

Zur ordnungsgemäßen Kühlung und Lüftung muß die Gehäuseabdeckung immer wieder vor dem Einschalten installiert werden. Ein Betrieb des Systems ohne angebrachte Abdeckung kann Ihrem System oder Teile darin beschädigen. Um die Abdeckung wieder anzubringen:

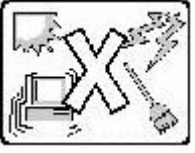

1. Vergewissern Sie sich, daß Sie keine Werkzeuge oder Teile im Innern des Systems zurückgelassen haben.
2. Überprüfen Sie alle Kabel, Zusatzkarten und andere Komponenten auf ordnungsgemäßen Sitz und Installation.
3. Bringen Sie die Abdeckungen wieder am Gehäuse an, indem Sie die zuvor gelösten Schrauben wieder anbringen. Ziehen Sie diese gut an.
4. Bringen Sie die Verschlusseinrichtung (Padlock) wieder an und schließen Sie diese, um ein unerlaubtes Öffnen des Systems zu verhindern.
5. Schließen Sie alle externen Kabel und den AC Stromanschlußstecker Ihres Systems wieder an.

	<p>Der Mikroprozessor und der Kühler sind möglicherweise erhitzt, wenn das System in Betrieb ist. Außerdem können einige Platinen und Gehäuseteile scharfe Spitzen und Kanten aufweisen. Arbeiten an Platinen und Gehäuse sollten vorsichtig ausgeführt werden. Sie sollten Schutzhandschuhe tragen.</p>
	<p>Bei falschem Einsetzen einer neuen Batterie besteht Explosionsgefahr. Die Batterie darf nur durch denselben oder einen entsprechenden, vom Hersteller empfohlenen Batterietyp ersetzt werden. Entsorgen Sie verbrauchte Batterien den Anweisungen des Herstellers entsprechend.</p>
	<p>Das System wurde für den Betrieb in einer normalen Büroumgebung entwickelt. Der Standort sollte:</p> <ul style="list-style-type: none"> • "sauber und staubfrei sein (Hausstaub ausgenommen); • "gut gelüftet und keinen Heizquellen ausgesetzt sein (einschließlich direkter Sonneneinstrahlung); • "keinen Erschütterungen ausgesetzt sein; • "keine starken, von elektrischen Geräten erzeugten elektromagnetischen Felder aufweisen; • "in Regionen, in denen elektrische Stürme auftreten, mit einem Überspannungsschutzgerät verbunden sein; während eines elektrischen Sturms sollte keine Verbindung der Telekommunikationsleitungen mit dem Modem bestehen; • "mit einer geerdeten Wechselstromsteckdose ausgerüstet sein; • "über ausreichend Platz verfügen, um Zugang zu den Netzkabeln zu gewährleisten, da der Stromanschluß des Produkts hauptsächlich über die Kabel unterbrochen wird

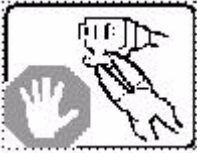
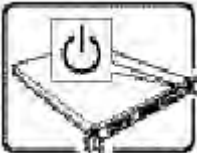

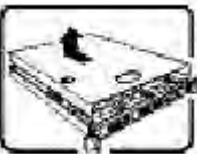
Français

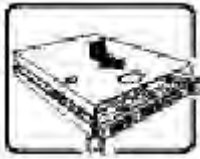

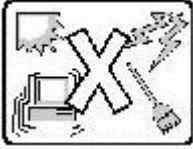

	<p>Le bloc d'alimentation de ce produit ne contient aucune pièce pouvant être réparée par l'utilisateur. Ce produit peut contenir plus d'un bloc d'alimentation. Veuillez contacter un technicien qualifié en cas de problème.</p>
---	--

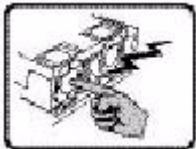
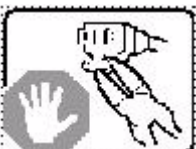
	<p>Ne pas essayer d'utiliser ni modifier le câble d'alimentation CA fourni, s'il ne correspond pas exactement au type requis. Le nombre de câbles d'alimentation CA fournis correspond au nombre de blocs d'alimentation du produit</p>
	<p>Notez que le commutateur CC de mise sous tension /hors tension du panneau avant n'éteint pas l'alimentation CA du système. Pour mettre le système hors tension, vous devez débrancher chaque câble d'alimentation de sa prise.</p>
	<p>CONSIGNES DE SÉCURITÉ -Lorsque vous ouvrez le boîtier pour accéder à l'intérieur du système, suivez les consignes suivantes:</p> <ol style="list-style-type: none"> 1. Mettez hors tension tous les périphériques connectés au système. 2. Mettez le système hors tension en mettant l'interrupteur général en position OFF (bouton-poussoir). 3. Débranchez tous les cordons d'alimentation c.a. du système et des prises murales. 4. Identifiez et débranchez tous les câbles reliés aux connecteurs d'E-S ou aux accès derrière le système. 5. Pour prévenir les décharges électrostatiques lorsque vous touchez aux composants, portez une bande antistatique pour poignet et reliez-la à la masse du système (toute surface métallique non peinte du boîtier). 6. Ne faites pas fonctionner le système tandis que le boîtier est ouvert.
	<p>Une fois TOUTES les étapes précédentes accomplies, vous pouvez retirer les panneaux du système. Procédez comme suit:</p> <ol style="list-style-type: none"> 1. Si un cadenas a été installé sur à l'arrière du système, déverrouillez-le et retirez-le. 2. Retirez toutes les vis des panneaux et mettez-les dans un endroit sûr. 3. Retirez les panneaux.

	<p>Afin de permettre le refroidissement et l'aération du système, réinstallez toujours les panneaux du boîtier avant de mettre le système sous tension. Le fonctionnement du système en l'absence des panneaux risque d'endommager ses pièces. Pour installer les panneaux, procédez comme suit:</p> <ol style="list-style-type: none"> 1. Assurez-vous de ne pas avoir oublié d'outils ou de pièces démontées dans le système. 2. Assurez-vous que les câbles, les cartes d'extension et les autres composants sont bien installés. 3. Revissez solidement les panneaux du boîtier avec les vis retirées plus tôt. 4. Remettez le cadenas en place et verrouillez-le afin de prévenir tout accès non autorisé à l'intérieur du système. 5. Rebranchez tous les cordons d'alimentation c. a. et câbles externes au système.
	<p>Le microprocesseur et le dissipateur de chaleur peuvent être chauds si le système a été sous tension. Faites également attention aux broches aiguës des cartes et aux bords tranchants du capot. Nous vous recommandons l'usage de gants de protection.</p>
	<p>Danger d'explosion si la batterie n'est pas remontée correctement. Remplacer uniquement avec une batterie du même type ou d'un type équivalent recommandé par le fabricant. Disposez des piles usées selon les instructions du fabricant.</p>
	<p>Le système a été conçu pour fonctionner dans un cadre de travail normal. L'emplacement choisi doit être:</p> <ul style="list-style-type: none"> • "Propre et dépourvu de poussière en suspension (sauf la poussière normale). • "Bien aéré et loin des sources de chaleur, y compris du soleil direct. • "A l'abri des chocs et des sources de vibrations. • "Isolé de forts champs électromagnétiques géénérés par des appareils électriques. • "Dans les régions sujettes aux orages magnétiques il est recomandé de brancher votre système à un supresseur de surtension, et de débrancher toutes les lignes de télécommunications de votre modem durant un orage. • "Muni d'une prise murale correctement mise à la terre. • "Suffisamment spacieux pour vous permettre d'accéder aux câbles d'alimentation (ceux-ci étant le seul moyen de mettre le système hors tension).

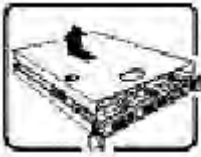
Español

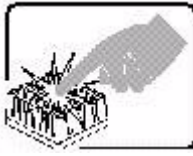
	<p>El usuario debe abstenerse de manipular los componentes de la fuente de alimentación de este producto, cuya reparación debe dejarse exclusivamente en manos de personal técnico especializado. Puede que este producto disponga de más de una fuente de alimentación</p>
	<p>No intente modificar ni usar el cable de alimentación de corriente alterna, si no corresponde exactamente con el tipo requerido. El número de cables suministrados se corresponden con el número de fuentes de alimentación de corriente alterna que tenga el producto</p>
	<p>Nótese que el interruptor activado/desactivado en el panel frontal no desconecta la corriente alterna del sistema. Para desconectarla, deberá desenchufar todos los cables de corriente alterna de la pared o desconectar la fuente de alimentación.</p>
	<p>INSTRUCCIONES DE SEGURIDAD: Cuando extraiga la tapa del chasis para acceder al interior del sistema, siga las siguientes instrucciones:</p> <ol style="list-style-type: none">1. Apague todos los dispositivos periféricos conectados al sistema.2. Apague el sistema presionando el interruptor encendido/apagado.3. Desconecte todos los cables de alimentación CA del sistema o de las tomas de corriente alterna.4. Identifique y desconecte todos los cables enchufados a los conectores E/S o a los puertos situados en la parte posterior del sistema.5. Cuando manipule los componentes, es importante protegerse contra la descarga electrostática (ESD). Puede hacerlo si utiliza una muñequera antiestática sujeta a la toma de tierra del chasis - o a cualquier tipo de superficie de metal sin pintar.6. No ponga en marcha el sistema si se han extraído las tapas del chasis.





	<p>Después de completar las seis instrucciones de SEGURIDAD mencionadas, ya puede extraer las tapas del sistema. Para ello:</p> <ol style="list-style-type: none"> 1. Desbloquee y extraiga el bloqueo de seguridad de la parte posterior del sistema, si se ha instalado uno. 2. Extraiga y guarde todos los tornillos de las tapas. Extraiga las tapas.
	<p>Para obtener un enfriamiento y un flujo de aire adecuados, reinstale siempre las tapas del chasis antes de poner en marcha el sistema. Si pone en funcionamiento el sistema sin las tapas bien colocadas puede dañar los componentes del sistema. Para instalar las tapas:</p> <ol style="list-style-type: none"> 1. Asegúrese primero de no haber dejado herramientas o componentes sueltos dentro del sistema. 2. Compruebe que los cables, las placas adicionales y otros componentes se hayan instalado correctamente. 3. Incorpore las tapas al chasis mediante los tornillos extraídos anteriormente, tensándolos firmemente. 4. Inserte el bloqueo de seguridad en el sistema y bloquéelo para impedir que pueda accederse al mismo sin autorización. 5. Conecte todos los cables externos y los cables de alimentación CA al sistema.
	<p>Si el sistema ha estado en funcionamiento, el microprocesador y el dissipador de calor pueden estar aún calientes. También conviene tener en cuenta que en el chasis o en el tablero puede haber piezas cortantes o punzantes. Por ello, se recomienda precaución y el uso de guantes protectores.</p>
	<p>Existe peligro de explosión si la pila no se cambia de forma adecuada. Utilice solamente pilas iguales o del mismo tipo que las recomendadas por el fabricante del equipo. Para deshacerse de las pilas usadas, siga igualmente las instrucciones del fabricante.</p>





El sistema está diseñado para funcionar en un entorno de trabajo normal. escoja un lugar:

- "Limpio y libre de partículas en suspensión (salvo el polvo normal).
- "Bien ventilado y alejado de fuentes de calor, incluida la luz solar directa.
- "Alejado de fuentes de vibración.
- "Aislado de campos electromagnéticos fuertes producidos por dispositivos eléctricos.
- "En regiones con frecuentes tormentas eléctricas, se recomienda conectar su sistema a un eliminador de sobrevoltage y desconectar el módem de las líneas de telecomunicación durante las tormentas.
- "Provisto de una toma de tierra correctamente instalada.
- "Provisto de espacio suficiente como para acceder a los cables de alimentación, ya que éstos hacen de medio principal de desconexión del sistema.

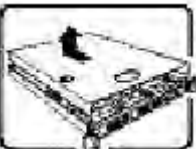
Italiano

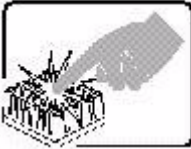
	<p>Rivolgersi ad un tecnico specializzato per la riparazione dei componenti dell'alimentazione di questo prodotto. È possibile che il prodotto disponga di più fonti di alimentazione.</p>
	<p>Non modificare o utilizzare il cavo di alimentazione in c.a. fornito dal produttore, se non corrisponde esattamente al tipo richiesto. Ad ogni fonte di alimentazione corrisponde un cavo di alimentazione in c.a. separato</p>
	<p>L'interruttore attivato/disattivato nel pannello anteriore non interrompe l'alimentazione in c.a. del sistema. Per interromperla, è necessario scollegare tutti i cavi di alimentazione in c.a. dalle prese a muro o dall'alimentazione di corrente.</p>
	<p>PASSI DI SICUREZZA: Qualora si rimuovano le coperture del telaio per accedere all'interno del sistema, seguire i seguenti passi:</p> <ol style="list-style-type: none">1. Spegner tutti i dispositivi periferici collegati al sistema.2. Spegner il sistema, usando il pulsante spento/acceso dell'interruttore del sistema.3. Togliere tutte le spine dei cavi del sistema dalle prese elettriche.4. Identificare e sconnettere tutti i cavi attaccati ai collegamenti I/O od alle prese installate sul retro del sistema.5. Qualora si tocchino i componenti, proteggersi dallo scarico elettrostatico (SES), portando un cinghia anti-statica da polso che è attaccata alla presa a terra del telaio del sistema - qualsiasi superficie non dipinta - .6. Non far operare il sistema quando il telaio è senza le coperture.
	<p>Dopo aver seguito i sei passi di SICUREZZA sopracitati, togliere le coperture del telaio del sistema come segue:</p> <ol style="list-style-type: none">1. Aprire e rimuovere il lucchetto dal retro del sistema qualora ve ne fosse uno installato.2. Togliere e mettere in un posto sicuro tutte le viti delle coperture.3. Togliere le coperture.

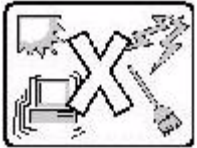
	<p>Per il giusto flusso dell'aria e raffreddamento del sistema, rimettere sempre le coperture del telaio prima di riaccendere il sistema. Operare il sistema senza le coperture al loro proprio posto potrebbe danneggiare i componenti del sistema. Per rimettere le coperture del telaio:</p> <ol style="list-style-type: none"> 1. Controllare prima che non si siano lasciati degli attrezzi o dei componenti dentro il sistema. 2. Controllare che i cavi, dei supporti aggiuntivi ed altri componenti siano stati installati appropriatamente. 3. Attaccare le coperture al telaio con le viti tolte in precedenza e avvitarle strettamente. 4. Inserire e chiudere a chiave il lucchetto sul retro del sistema per impedire l'accesso non autorizzato al sistema. 5. Ricollegare tutti i cavi esterni e le prolunghere AC del sistema.
	<p>Se il sistema è stato a lungo in funzione, il microprocessore e il dissipatore di calore potrebbero essere surriscaldati. Fare attenzione alla presenza di piedini appuntiti e parti taglienti sulle schede e sul telaio. È consigliabile l'uso di guanti di protezione.</p>
	<p>Esiste il pericolo di un'esplosione se la pila non viene sostituita in modo corretto. Utilizzare solo pile uguali o di tipo equivalente a quelle consigliate dal produttore. Per disfarsi delle pile usate, seguire le istruzioni del produttore.</p>
	<p>Il sistema è progettato per funzionare in un ambiente di lavoro tipo. Scegliere una postazione che sia:</p> <ul style="list-style-type: none"> • "Pulita e libera da particelle in sospensione (a parte la normale polvere presente nell'ambiente). • "Ben ventilata e lontana da fonti di calore, compresa la luce solare diretta. • "Al riparo da urti e lontana da fonti di vibrazione. • "Isolata dai forti campi magnetici prodotti da dispositivi elettrici. • "In aree soggette a temporali, è consigliabile collegare il sistema ad un limitatore di corrente. In caso di temporali, scollegare le linee di comunicazione dal modem. • "Dotata di una presa a muro correttamente installata. • "Dotata di spazio sufficiente ad accedere ai cavi di alimentazione, i quali rappresentano il mezzo principale di scollegamento del sistema.

System Specifications

This appendix lists the system specifications for the Intel® Server System SR2612UR.

System Server

- Intel® Tylersburg chipset (IOH36D, ICH10R)
- CPUs: Up to two dual- or quad-core Intel® Xeon® Nehalem EP processors
- Up to 12 DDR3 RDIMMs 1333Mhz (96GB max)
- Up to five PCI-e Gen 2 slots for expansion and customization (three full height/full length, two half height)
- External Ports: mouse, keyboard, RS232 COM, 1Gb Ethernet (2), VGA monitor, and USB (4)

Host Expansion/Interfaces

- Integrated Dual 1Gb Ethernet
- 10 Gb Ethernet, Fibre Channel, SAS (selectable through PCI card)
- SAS ports for expansion connections (on PCI card)
- Up to 1200 MB/s throughput bandwidth (application dependant)

Measured Performance

- Up to 750 MB/s (sustained reads)

Capacity

- Up to 12 drives or 24 TB capacity per 2U enclosure (using available 2 TB HDDs)

Firmware

- SCSI Enclosure Services (SES) 2.0 based firmware

Applications

- Microsoft Windows* Storage Server™
- VMware ESX*, Microsoft Hyper-V™ and Citrix* XenServer™ virtualization
- Open-E* Data Storage Server (DSSTM)
- AMI StorTrends*
- Unified NAS/iSCSI

Redundant Hot-swappable Components

- Two power supply modules
- Two independent AC power inlets with domestic NEMA power cords
- Up to 12 drives

Maximum Cable Lengths (Customer Supplied)

- 3 Gbps SAS: Up to 6m
- 1 Gb Ethernet: up to 10m

Raid Features

- RAID 0,1,10,5,50,6,60 (PCI RAID adapter dependant)
- OS software RAID capable
- Auto-negotiate speeds
- In-band and out-of-band management
- SAS/SMP/SSP protocol support
- Redundant cable support

2U Rackmount Enclosure

- Dimensions: 3.5 inches H x 17.6 inches W x 31 inches D (8.9 cm H x 44.7 cm W x 78.7 cm D)
- Weight with drives: 70 lbs (35 kg) max
- Standard Rackmount Rail Kit Adjustable Depth: 28.0 inches to 34.0 inches (71.1 cm to 86.4 cm)

Disk Drives

- 12 independent 300MB/s point-to-point connections to each SAS or SATA disk drive
- Common universal dual-purpose drive carrier/ blank for all 3.5-inch NDS standard products
- Form factor:
 - External: 3.5-inch SAS and SATA HDDs
 - Internal: 2.5-inch SATA HDDs/SSDs (single or dual)
- Rotational speed: 7200 RPM, 10K RPM, and 15K RPM
- Interface: 3 Gb SAS; 3 Gb/1.5 Gb SATA

AC Power

- Input voltage: Auto ranging, 90-264VAC
- Input frequency: 47-63 Hz
- Power factor correction: Per EN61000-3-2
- Input current: 8.8 Amps RMS max @ 100VAC
- Output power: 760 W peak
- Efficiency: 91% @ 230VAC, 50% load
- Variable speed “smart fans”

Supported Options

- One DVD drive
- Up to five PCI-E expansion cards
- Up to two 2.5-inch internal SATA drives

Operating Environment

- Temperature: 0° to 35°C
- Temperature gradient: 20°C per hour
- Relative humidity: 10 to 80 percent (non-condensing)
- Humidity gradient: 10% per hour
- Altitude: -200 to 10,000 ft.
- Shock: 5G at 11ms, 1/2 sine wave pulse
- Vibration: 0.15G at 5Hz to 400Hz
- Acoustics: 7 Bels at normal operation tested to ISO7779

Non-Operating Environment

- Temperature: -40° to 70°C
- Relative humidity: 5% to 95% (non-condensing)
- Altitude: -200 to 40,000 ft.
- Shock: 10G at 11ms, 1/2 sine wave pulse
- Vibration: 0.5G at 5Hz to 400Hz

Optional DVD

- Internally mounted slim DVD with SATA interposer card/cable (rear accessible)

Electromagnetic Emissions and Immunity Standards

- CE Mark, EN55022/EN61000 Class A
- FCC Class A, Canadian IECS-003
- VCCI Class A

Safety Standards

- UL 60950, CSA 22.2-950
- IEC 60950, EN 60950

Quality Standards

- Manufactured under an ISO 9002 registered quality system

Environmental Protection

- RoHS and WEEE compliant

Failure Notifications

- SCSI Enclosure Services (SES-2) over I2C physical interface, LEDs, audible alarms, field replaceable unit (FRU) revision and serial number reporting

Monitoring

- Temperature, power supply modules, fan speed control, disk drives and I/O module(s), as well as error rates and quality of service

Qualifications

For Newisys qualifications relative to supported options for specific disk drives, software application environments, PCI adapters, and so on, go to www.newisys.com/support.

G Safety Information

English

Server Safety Information

This document applies to Intel® server boards, Intel® server chassis and installed peripherals. To reduce the risk of bodily injury, electrical shock, fire, and equipment damage, read this document and observe all warnings and precautions in this guide before installing or maintaining your Intel® server product.



In the event of a conflict between the information in this document and information provided with the product or on the website for a particular product, the product documentation takes precedence.





Your server should be integrated and serviced only by technically qualified persons.

You must adhere to the guidelines in this guide and the assembly instructions in your server manuals to ensure and maintain compliance with existing product certifications and approvals. Use only the described, regulated components specified in this guide. Use of other products / components will void the UL Listing and other regulatory approvals of the product, and may result in noncompliance with product regulations in the region(s) in which the product is sold.

Safety Warnings and Cautions

To avoid personal injury or property damage, before you begin installing the product, read, observe, and adhere to all of the following safety instructions and information. The following safety symbols may be used throughout the documentation and may be marked on the product and / or the product packaging.

CAUTION	Indicates the presence of a hazard that may cause minor personal injury or property damage if the CAUTION is ignored.
WARNING	Indicates the presence of a hazard that may result in serious personal injury if the WARNING is ignored.
	Indicates potential hazard if indicated information is ignored.
	Indicates shock hazards that result in serious injury or death if safety instructions are not followed.

	Indicates hot components or surfaces.
	Indicates do not touch fan blades, may result in injury.
	Indicates to unplug all AC power cord(s) to disconnect AC power
	Please recycle battery

Intended Application Uses

This product was evaluated as Information Technology Equipment (ITE), which may be installed in offices, schools, computer rooms, and similar commercial type locations. The suitability of this product for other product categories and environments (such as medical, industrial, residential, alarm systems, and test equipment), other than an ITE application, may require further evaluation.

Site Selection

The compute module is designed to operate in a typical office environment. Choose a site that is:

- Clean, dry, and free of airborne particles (other than normal room dust).
- Well-ventilated and away from sources of heat including direct sunlight and radiators.
- Away from sources of vibration or physical shock.
- Isolated from strong electromagnetic fields produced by electrical devices.
- In regions that are susceptible to electrical storms, we recommend you plug your compute module into a surge suppressor and disconnect telecommunication lines to your modem during an electrical storm.
- Provided with a properly grounded wall outlet.
- Provided with sufficient space to access the power supply cord(s), because they serve as the product's main power disconnect.

Equipment Handling Practices

Reduce the risk of personal injury or equipment damage:

- Conform to local occupational health and safety requirements when moving and lifting equipment.

- Use mechanical assistance or other suitable assistance when moving and lifting equipment.
- To reduce the weight for easier handling, remove any easily detachable components.

Power and Electrical Warnings

Caution: *The power button, indicated by the stand-by power marking, DOES NOT completely turn off the compute module AC power, 5V standby power is active whenever the compute module is plugged in. To remove power from compute module, you must unplug the AC power cord from the wall outlet. Your compute module may use more than one AC power cord. Make sure all AC power cords are unplugged. Make sure the AC power cord(s) is/are unplugged before you open the chassis, or add or remove any non hot-plug components.*

Do not attempt to modify or use an AC power cord if it is not the exact type required. A separate AC cord is required for each compute module power supply.

Some power supplies in Intel® servers use Neutral Pole Fusing. To avoid risk of shock use caution when working with power supplies that use Neutral Pole Fusing.

The power supply in this product contains no user-serviceable parts. Do not open the power supply. Hazardous voltage, current and energy levels are present inside the power supply. Return to manufacturer for servicing.

When replacing a hot-plug power supply, unplug the power cord to the power supply being replaced before removing it from the server.

To avoid risk of electric shock, turn off the server and disconnect the power cord, telecommunications systems, networks, and modems attached to the server before opening it.

Access Warnings

Caution: *To avoid personal injury or property damage, the following safety instructions apply whenever accessing the inside of the product:*

- *Turn off all peripheral devices connected to this product.*
- *Turn off the compute module by pressing the power button off.*
- *Disconnect the AC power by unplugging all AC power cords from the chassis or wall outlet.*
- *Disconnect all cables and telecommunication lines that are connected to the compute module.*
- *Retain all screws or other fasteners when removing access cover(s). Upon completion of accessing inside the product, refasten access cover with original screws or fasteners.*
- *Do not access the inside of the power supply. There are no serviceable parts in the power supply. Return to manufacturer for servicing.*
- *Power down the chassis and disconnect all power cords before adding or replacing any non hot-plug component.*

- *When replacing a hot-plug power supply, unplug the power cord to the power supply being replaced before removing the power supply from the chassis.*

Caution: *If the compute module has been running, any installed processor(s) and heat sink(s) may be hot. Unless you are adding or removing a hot-plug component, allow the compute module to cool before opening the covers. To avoid the possibility of coming into contact with hot component(s) during a hot-plug installation, be careful when removing or installing the hot-plug component(s).*

Caution: *To avoid injury do not contact moving fan blades. If your chassis is supplied with a guard over the fan, do not operate the chassis without the fan guard in place.*

Electrostatic Discharge (ESD)

Caution: *ESD can damage disk drives, boards, and other parts. We recommend that you perform all procedures at an ESD workstation. If one is not available, provide some ESD protection by wearing an antistatic wrist strap attached to chassis ground -- any unpainted metal surface -- on your server when handling parts.*

Always handle boards carefully. They can be extremely sensitive to ESD. Hold boards only by their edges. After removing a board from its protective wrapper or from the server, place the board component side up on a grounded, static free surface. Use a conductive foam pad if available but not the board wrapper. Do not slide board over any surface.

Other Hazards

Battery Replacement

Caution: *There is the danger of explosion if the battery is incorrectly replaced. When replacing the battery, use only the battery recommended by the equipment manufacturer.*

Dispose of batteries according to local ordinances and regulations.

Do not attempt to recharge a battery.

Do not attempt to disassemble, puncture, or otherwise damage a battery.

Cooling and Airflow

Caution: *Carefully route cables as directed to minimize airflow blockage and cooling problems.*

For proper cooling and airflow, operate the chassis only with the chassis covers installed. Operating the chassis without the covers in place can damage chassis parts. To install the covers:

- *Check first to make sure you have not left loose tools or parts inside the chassis*
- *Check that cables, add-in boards, and other components are properly installed.*
- *Attach the covers to the chassis according to the product instructions.*

Laser Peripherals or Devices

Caution: *To avoid risk of radiation exposure and/or personal injury:*

- *Do not open the enclosure of any laser peripheral or device*
- *Laser peripherals or devices have are not user serviceable*
- *Return to manufacturer for servicing*

Deutsch

Sicherheitshinweise für den Server

Das vorliegende Dokument bezieht sich auf Intel® Serverplatinen, Intel® Servergehäuse (Standfuß und Rack) sowie installierte Peripheriegeräte. Es enthält Warnungen und Vorsichtsmaßnahmen zur Vermeidung von Gefahren durch Verletzung, Stromschlag, Feuer und Beschädigungen von Geräten. Lesen Sie diese Dokument daher sorgfältig, bevor Sie Ihr Intel® Serverprodukt installieren oder warten.

Bei Widersprüchen zwischen den hier vorliegenden Angaben und den Informationen im Lieferumfang des Produkts oder auf der Website des betreffenden Produkts hat die Produktdokumentation Vorrang.







Die Integration und Wartung des Servers darf nur durch technisch qualifizierte Personen erfolgen.

Um die Einhaltung der vorhandenen Zulassungen und Genehmigungen für das Produkt zu gewährleisten, sind die Richtlinien in diesem Handbuch sowie die Montageanleitungen in den Serverhandbüchern zu beachten. Verwenden Sie nur die beschriebenen, zugelassenen Komponenten, die im vorliegenden Handbuch angegeben werden. Die Verwendung anderer Produkte oder Komponenten führt zum Erlöschen der UL-Zulassung und anderer Genehmigungen für das Produkt. Dadurch kann das Produkt gegen Produktbestimmungen verstoßen, die im Verkaufsland gelten.

Sicherheitshinweise und Vorsichtsmaßnahmen

Um Verletzungen und Beschädigungen zu vermeiden, sollten Sie vor dem Beginn der Produktinstallation die nachfolgend aufgeführten Sicherheitshinweise und -informationen sorgfältig lesen und befolgen. In dem vorliegenden Handbuch sowie auf dem Produkt und auf der Verpackung werden folgende Sicherheitssymbole verwendet:

VORSICHT	Weist auf eine Gefahrenquelle hin, die bei Nichtbeachtung des VORSICHTSHINWEISES zu leichteren Verletzungen bzw. Sachbeschädigungen führen kann.
WARNUNG	Weist auf eine Gefahrenquelle hin, die bei Nichtbeachtung der WARNUNG zu ersten Verletzungen führen kann.

	Weist auf potentielle Gefahr bei Nichtbeachtung der angezeigten Informationen hin.
	Weist auf die Gefahr eines Stromschlags hin, der bei Nichtbeachtung der Sicherheitshinweise zu schweren oder tödlichen Verletzungen führen kann.
	Weist auf Verbrennungsgefahr an heißen Bauteilen bzw. Oberflächen hin.
	Weist darauf hin, daß das Anfassen des Gebläses zu Verletzungen führen kann.
	Bedeutet, alle Netzkabel abzuziehen und das Gerät von der Netzspannung zu trennen.
	Bereiten Sie bitte Batterie auf

Zielbenutzer der Anwendung

Dieses Produkt wurde in seiner Eigenschaft als IT-Gerät getestet, das in Büros, Schulen, Computerräumen und ähnlichen öffentlichen Räumlichkeiten installiert werden kann. Die Eignung dieses Produkts für andere Einsatzbereiche als IT (z. B. Medizin, Industrie, Alarmsysteme oder Prüfgeräte) kann u. U. weitere Tests erfordern.

Standortauswahl

Das System ist für den Betrieb innerhalb normaler Büroumgebungen geeignet. Wählen Sie einen Standort, der folgenden Kriterien entspricht:

- Sauber, trocken und frei von Partikeln in der Luft (außer dem normalen Raumstaub).
- Gut belüftet, nicht in der Nähe von Wärmequellen und keiner direkten Sonnenbestrahlung ausgesetzt.
- Nicht in der Nähe von Vibrations- oder Erschütterungsquellen.
- Abgeschirmt von starken elektromagnetischen Feldern, die durch elektrische Geräte erzeugt werden.
- In gewittergefährdeten Gebieten sollten Sie das System an einen Überspannungsschutz anschließen und bei einem Gewitter die Telekommunikationskabel zum Modem abziehen.
- Eine ordnungsgemäß geerdete Wandsteckdose muß vorhanden sein.
- Ausreichender Freiraum für den Zugang zu den Netzkabeln, da diese die Hauptvorrichtung zum Trennen des Produkts von der Stromversorgung sind.

Handhabung von Geräten

Beachten Sie zur Vermeidung von Verletzungen oder Beschädigungen an den Geräten die folgenden Hinweise:

- Halten Sie beim Transportieren und Anheben von Geräten die örtlichen Gesundheits- und Sicherheitsvorschriften ein.
- Verwenden Sie mechanische oder andere geeignete Hilfsmittel zum Transportieren oder Anheben von Geräten.
- Entfernen Sie alle Komponenten, die sich leicht abnehmen lassen, um das Gewicht zu reduzieren und die Handhabung zu erleichtern.

Warnungen zu Netzspannung und Elektrizität

Vorsicht: Durch Betätigen der mit dem Standby-Symbol gekennzeichneten Netztaaste wird das System NICHT vollständig vom Netz getrennt. Es sind weiterhin 5 V aktiv, solange das System eingesteckt ist. Um das System vollständig vom Strom zu trennen, muß das Netzkabel aus der Steckdose abgezogen werden. Das System verfügt möglicherweise über mehrere Netzkabel. Vergewissern Sie sich in diesem Fall, daß alle Netzkabel abgezogen sind. Wenn Sie Komponenten ein- oder ausbauen möchten, die nicht hot-plug-fähig sind, stellen Sie sicher, daß zuvor alle Netzkabel abgezogen sind.

Nehmen Sie keine Änderungen am Netzkabel vor, und verwenden Sie kein Kabel, das nicht genau dem geforderten Typ entspricht. Jedes Netzteil im System muß über ein eigenes Netzkabel angeschlossen werden.

Einige Netzteile von Intel Servern verwenden Nullleitersicherungen. Vorsicht ist geboten im Umgang mit Netzteilen, welche Nullleitersicherungen verwenden, um das Risiko eines elektrischen Schlages zu vermeiden

Das Netzteil in diesem Produkt enthält keine Teile, die vom Benutzer gewartet werden können. Öffnen Sie das Netzteil nicht. Im Netzteil bestehen gefährliche Spannungen, Ströme und Energiequellen. Schicken Sie das Gerät für Wartungsarbeiten an den Hersteller zurück.

Wenn Sie ein hot-plug-fähiges Netzteil austauschen, ziehen Sie dessen Netzkabel ab, bevor Sie es aus dem Server ausbauen.

Zur Vermeidung von Stromschlägen schalten Sie den Server aus, und trennen Sie vor dem Öffnen des Geräts das Netzkabel sowie alle an den Server angeschlossene Telekommunikationssysteme, Netzwerke und Modems.

Warnhinweise für den Systemzugang

Vorsicht: Um Verletzungen und Beschädigungen zu vermeiden, sollten Sie vor Arbeiten im Produktinneren folgende Sicherheitsanweisungen beachten:

- Schalten Sie alle am Produkt angeschlossenen Peripheriegeräte aus.
- Schalten Sie das System mit dem Netzschalter aus.
- Trennen Sie das Gerät von der Stromquelle, indem Sie alle Netzkabel vom System bzw. aus der Steckdose ziehen.
- Ziehen Sie alle Kabel und alle an das System angeschlossenen Telekommunikationsleitungen ab.
- Bewahren Sie alle Schrauben und anderen Befestigungselemente gut auf, nachdem Sie die Gehäuseabdeckung entfernt haben. Wenn Sie Ihre Arbeiten im Systeminneren beendet haben, befestigen Sie die Gehäuseabdeckung mit den Originalschrauben bzw. -befestigungselementen.
- Führen Sie keine Arbeiten im Netzteil aus. Das Netzteil enthält keine für den Benutzer wartungsbedürftigen Teile. Schicken Sie das Gerät für Wartungsarbeiten an den Hersteller zurück.
- Schalten Sie den Server aus, und ziehen Sie alle Netzkabel ab, bevor Sie Komponenten ein- oder ausbauen, die nicht hot-plug-fähig sind.

- Wenn Sie ein hot-plug-fähiges Netzteil austauschen, ziehen Sie dessen Netzkabel ab, bevor Sie es aus dem Server ausbauen.

Vorsicht: War Ihr Server in Betrieb, können die installierten Prozessoren und Kühlkörper heiß sein. Sofern Sie keine Hot-Plug-Komponenten ein- oder ausbauen, warten Sie mit dem Abnehmen der Abdeckungen, bis das System abgekühlt ist. Gehen Sie beim Aus- oder Einbauen von Hot-Plug-Komponenten sorgfältig vor, um nicht mit heißen Komponenten in Berührung zu kommen.

Vorsicht: Berühren Sie nicht die rotierenden Lüfterflügel, um Verletzungen zu vermeiden. Falls Ihr System mit einer Lüfterabdeckung besitzt, darf es nicht ohne diese Abdeckung betrieben werden.

Elektrostatische Entladungen (ESD)

Vorsicht: Elektrostatische Entladungen können zur Beschädigung von Festplatten, Platinen und anderen Komponenten führen. Daher sollten Sie alle Arbeiten an einer ESD-Workstation ausführen. Steht ein solcher Arbeitsplatz nicht zur Verfügung, erzielen Sie einen gewissen Schutz vor elektrostatischen Entladungen durch Tragen einer Antistatik-Manschette, die Sie während der Arbeit zur Erdung an einem beliebigen unlackierten Metallteil des Computergehäuses befestigen.

Gehen Sie bei der Handhabung von Platinen immer mit größter Vorsicht vor. Sie können äußerst empfindlich gegenüber elektrostatischer Entladung sein. Halten Sie Platinen nur an den Kanten fest. Legen Sie die Platinen nach dem Auspacken aus der Schutzhülle oder nach dem Ausbau aus dem Server mit der Bauelementseite nach oben auf eine geerdete, statisch entladene Unterlage. Verwenden Sie dazu, sofern verfügbar, eine leitfähige Schaumstoffunterlage, aber nicht die Schutzhülle der Platine. Ziehen Sie die Platine nicht über eine Fläche.

Andere Gefahren

Batterieaustausch

Vorsicht: Wird die Batterie unsachgemäß ausgetauscht, besteht Explosionsgefahr. Verwenden Sie als Ersatz nur die vom Gerätehersteller empfohlene Batterie.

Beachten Sie bei der Entsorgung von Batterien die gültigen Bestimmungen.

Versuchen Sie nicht, eine Batterie aufzuladen.

Versuchen Sie nicht, eine Batterie zu öffnen oder sonstwie zu beschädigen.

Kühlung und Luftstrom

Vorsicht: Verlegen Sie Kabel sorgfältig entsprechend der Anleitung, um Störungen des Luftstroms und Kühlungsprobleme zu vermeiden.

Zur Gewährleistung des ordnungsgemäßen Kühlungs- und Luftstromverhaltens darf das System nur mit angebrachten Gehäuseabdeckungen betrieben werden. Die Inbetriebnahme des Systems ohne Abdeckung kann zur Beschädigung von Systemkomponenten führen. So bringen Sie die Abdeckung wieder an:

- Vergewissern Sie sich zunächst, daß Sie keine Werkzeuge oder Teile im Gehäuse vergessen haben.
- Prüfen Sie, ob Kabel, Erweiterungskarten sowie weitere Komponenten ordnungsgemäß angebracht sind.
- Befestigen Sie die Abdeckungen am Gehäuse des Produkts, wie in dessen Anleitung beschrieben.

Laser-Peripheriegeräte oder -Komponenten

Vorsicht: Beachten Sie zur Vermeidung von Strahlung und Verletzungen die folgenden Hinweise:

- Öffnen Sie keinesfalls das Gehäuse von Laser-Peripheriegeräten oder Laser-Komponenten.
- Laser-Peripheriegeräte oder -Komponenten besitzen keine für den Benutzer wartungsbedürftigen Teile.
- Schicken Sie das Gerät für Wartungsarbeiten an den Hersteller zurück.

Français

Consignes de sécurité sur le serveur

Ce document s'applique aux cartes serveur Intel[®], au châssis de serveur Intel[®] (sur pieds et sur rack) et aux périphériques installés. Pour réduire les risques de dommages corporels, d'électrocution, d'incendie et de dommages matériels, lisez ce document et respectez tous les avertissements et précautions mentionnés dans ce guide avant d'installer ou de mettre à jour votre produit serveur Intel[®].





En cas de conflit entre les informations fournies dans ce document et celles livrées avec le produit ou publiées sur le site Web pour un produit particulier, la documentation du produit prime.

Votre serveur doit être intégré et entretenu uniquement par des techniciens qualifiés.

Vous devez suivre les informations de ce guide et les instructions d'assemblage des manuels de serveur pour vérifier et maintenir la conformité avec les certifications et approbations de produit existantes. Utilisez uniquement les composants décrits et réglementés spécifiés dans ce guide. L'utilisation d'autres produits/composants annulera la liste UL et les autres approbations réglementaires du produit, et le produit peut ne pas être conforme aux autres lois et réglementations locales applicables au produit.

Sécurité: avertissements et mises en garde

Pour éviter de vous blesser ou d'endommager votre équipement, lisez et respectez toutes les informations et consignes de sécurité avant de commencer l'installation du produit. Les symboles de sécurité suivants peuvent être utilisés tout au long de cette documentation et peuvent figurer sur le produit ou sur son emballage.

ATTENTION	Indique la présence d'un risque pouvant entraîner des blessures physiques mineures ou endommager légèrement le matériel si la mise en garde n'est pas prise en compte.
AVERTISSEMENT	Indique la présence d'un risque pouvant entraîner des blessures corporelles graves si l'avertissement n'est pas pris en compte.
	Indique un risque potentiel si les informations signalées ne sont pas prises en compte.
	Indique des risques d'électrocution pouvant entraîner des blessures corporelles graves ou mortelles si les consignes de sécurité ne sont pas respectées.
	Signale des composants ou des surfaces soumis à des températures élevées.
	Indique de ne pas toucher aux pales de ventilateur, car cela peut entraîner des blessures.



Indique de débrancher tous les cordons d'alimentation secteur pour déconnecter l'alimentation.



Veillez réutiliser la batterie

Domaines d'utilisation prévus

Ce produit a été testé comme équipement informatique (ITE) et peut être installé dans des bureaux, des écoles, des salles informatiques et des endroits commerciaux similaires. L'utilisation du présent produit dans des catégories et environnements de produits et domaines d'application (par exemple, le domaine médical, industriel, résidentiel, les systèmes d'alarme et les appareils de contrôle) autres qu'ITE doit faire l'objet d'évaluations supplémentaires.

Sélection d'un emplacement

Le système est conçu pour fonctionner dans un environnement standard de bureau. Choisissez un emplacement respectant les conditions suivantes :

- Propre, sec et exempt de particules en suspension (autres que la poussière normale d'une pièce).
- Bien ventilé et à l'écart des sources de chaleur telles que la lumière directe du soleil et les radiateurs.
- À l'écart des sources de vibration ou des chocs physiques.
- Isolé des champs électromagnétiques importants produits par des appareils électriques.
- Dans les régions sujettes aux orages magnétiques, nous vous recommandons de brancher votre système à un suppresseur de surtension et de déconnecter les lignes de télécommunication de votre modem pendant les orages.
- Équipé d'une prise murale reliée à la terre.
- Équipé d'un espace suffisant pour accéder aux cordons d'alimentation secteur, car ils servent de disjoncteur principal d'alimentation du produit.

Pratiques de manipulation de l'équipement

Réduisez le risque de dommages personnels ou matériels :

- Conformez-vous aux exigences de médecine du travail et de sécurité lorsque vous déplacez et soulevez le matériel.
- Utilisez l'assistance mécanique ou toute autre assistance appropriée lorsque vous déplacez et soulevez le matériel.
- Pour réduire le poids en vue de faciliter la manipulation, retirez tout composant amovible.

Alimentation et avertissements en matière d'électricité

Attention: Le bouton d'alimentation, indiqué par le symbole de mise en veille, NE COUPE PAS complètement l'alimentation secteur du système car le courant de veille 5 V reste actif lorsque le système est sous tension. Pour couper l'alimentation du système, vous devez débrancher le cordon d'alimentation secteur de la prise murale. Votre système peut utiliser plusieurs cordons d'alimentation secteur. Assurez-vous que tous les cordons d'alimentation sont débranchés. Vous devez les débrancher avant d'ouvrir le châssis, d'ajouter ou de supprimer un composant non connectable à chaud.

Les alimentations de certains serveurs Intel sont munies de doubles fusibles pôle/neutre: veuillez observer les précautions d'usage afin d'éviter tout risque d'électrocution.

N'essayez pas de modifier ou d'utiliser un cordon d'alimentation secteur s'il ne s'agit pas du type exact requis. Un cordon secteur est requis pour chaque alimentation système.

Le bloc d'alimentation de ce produit ne contient aucun composant réparable par l'utilisateur. N'ouvrez pas le bloc d'alimentation. L'intérieur de celui-ci est soumis à des niveaux dangereux de tension, de courant et d'énergie. Renvoyez-le au fabricant en cas de problème.

Lorsque vous remplacez un bloc d'alimentation à chaud, débranchez le cordon du bloc d'alimentation en cours de remplacement avant de le retirer du serveur.

Pour éviter tout risque d'électrocution, mettez le système hors tension et débranchez les cordons d'alimentation ainsi que les systèmes de télécommunication, réseaux et modems reliés au système avant d'ouvrir ce dernier.

Avertissements sur l'accès au système

Attention: Pour éviter de vous blesser ou d'endommager votre équipement, les consignes de sécurité suivantes s'appliquent chaque fois que vous accédez à l'intérieur du produit:

- Mettez hors tension tous les périphériques connectés à ce produit.
- Éteignez le système en appuyant sur le bouton d'alimentation.
- Déconnectez l'alimentation secteur en débranchant tous les cordons d'alimentation secteur du système ou de la prise murale.
- Déconnectez l'ensemble des câbles et lignes de télécommunication qui sont connectés au système.
- Mettez toutes les vis ou autres attaches de côté lorsque vous retirez les panneaux d'accès. Une fois que vous avez terminé d'accéder à l'intérieur du produit, refixez le panneau d'accès avec les vis ou attaches d'origine.
- N'essayez pas d'accéder à l'intérieur du bloc d'alimentation. Il ne contient aucune pièce réparable. Renvoyez-le au fabricant en cas de problème.
- Mettez le serveur hors tension et débranchez tous les cordons d'alimentation avant d'ajouter ou de remplacer tout composant non connectable à chaud.
- Lorsque vous remplacez le bloc d'alimentation à chaud, débranchez le cordon du bloc d'alimentation en cours de remplacement avant de retirer le bloc du serveur.

Attention: Si le serveur a été utilisé, les processeurs et dissipateurs de chaleur installés peuvent être chauds. À moins que vous n'ajoutiez ou ne retiriez un composant connectable à chaud, laissez le système refroidir avant d'ouvrir les panneaux. Pour éviter tout risque d'entrer en contact avec un composant chaud lors d'une installation à chaud, prenez toutes les précautions nécessaires lorsque vous retirez ou installez des composants connectables à chaud.

Attention: Pour éviter de vous blesser, ne touchez pas les pales de ventilateur en mouvement. Si votre système est fourni avec une protection sur le ventilateur, ne mettez pas le système en route sans la protection en place.

Décharges électrostatiques (ESD)

Attention: Les décharges électrostatiques (ESD) peuvent endommager les lecteurs de disque dur, les cartes et d'autres pièces. Il est fortement conseillé d'effectuer l'ensemble des procédures décrites à un poste de travail protégé contre les ESD. Au cas où aucun poste de ce type ne serait disponible, protégez-vous contre les ESD en portant un bracelet antistatique relié à la masse du châssis (n'importe quelle surface métallique non peinte) de votre serveur lorsque que vous manipulez les pièces.

Manipulez toujours les cartes avec précaution. Elles peuvent être extrêmement sensibles aux ESD. Ne tenez les cartes que par leurs bords. Après avoir retiré une carte de son emballage de protection ou du serveur, placez-la sur une surface reliée à la terre, exempte de charge statique, composants orientés vers le haut. Utilisez si possible un tapi de mousse conducteru, mais pas l'emballage de la carte. Veillez à ce que la carte ne glisse sur aucune surface.

Autres risques

Remplacement de la pile

Attention: Il existe un risque d'explosion si la pile n'est pas correctement remplacée. Lors du remplacement de la pile, utilisez uniquement celle recommandée par le fabricant du matériel.

Mettez la pile au rebut en vous conformant aux réglementations locales.

N'essayez pas de recharger une pile.

N'essayez pas de démonter, de percer ou d'endommager la pile d'une quelconque façon.

Refroidissement et ventilation

Attention: Routez les câbles avec précaution comme indiqué pour minimiser les blocages de circulation d'air et les problèmes de refroidissement.

Afin de permettre une ventilation et un refroidissement corrects, ne mettez le système en marche que lorsque les panneaux du châssis sont en place. L'utilisation du système sans les panneaux peut endommager les composants système. Pour installer les panneaux :

- Vérifiez tout d'abord que vous n'avez pas oublié d'outils ou de composants détachés à l'intérieur du système.
- Vérifiez que les câbles, les cartes d'extension et les autres composants sont correctement installés.
- Fixez les panneaux au châssis en suivant les instructions du produit.

Périphériques laser

Attention: Pour éviter tout risque d'exposition aux rayonnements et/ou de dommage personnel:

- N'ouvrez pas l'enceinte d'un périphérique laser.
- Les périphériques laser ne sont pas réparables par l'utilisateur.
- Retournez-les au fabricant en cas de problème.

Español

Información de seguridad del servidor

Este documento se aplica a las tarjetas de servidor de Intel[®], los gabinetes de servidor de Intel[®] (montaje en rack y en pedestal) y los dispositivos periféricos. Para reducir el riesgo de daños corporales, descargas eléctricas, fuego y en el equipo, lea este documento y preste atención a todas las advertencias y precauciones de esta guía antes de instalar o mantener el producto de servidor de Intel[®].







En el caso de que haya diferencias entre la información para un producto en particular contenida en este documento y la información proporcionada con dicho producto o en el sitio Web, la documentación del producto es la que prevalece.

Sólo personal técnico calificado debe montar y prestar los servicios para el servidor.

Debe ceñirse a las directrices de esta guía y a las instrucciones de montaje de los manuales del servidor para asegurar y mantener el cumplimiento con las certificaciones y homologaciones existentes de los productos. Utilice sólo los componentes descritos y homologados que se especifican en esta guía. El uso de otros productos o componentes anulará la homologación UL y otras certificaciones oficiales del producto, pudiendo dejar de ser compatible con las normativas locales de los países en los que se comercializa.

Advertencias y precauciones sobre seguridad

Para reducir la posibilidad de que se produzcan lesiones personales o daños en la propiedad, antes de empezar a instalar el producto, lea, observe y cumpla toda la información e instrucciones de seguridad siguientes. Puede que se utilicen los siguientes símbolos de seguridad en la documentación y es posible que aparezcan en el producto o en su embalaje.

PRECAUCIÓN	Indica la existencia de un riesgo que podría causar lesiones personales o daños en la propiedad leves si no se tiene en cuenta la PRECAUCIÓN.
ADVERTENCIA	Indica la existencia de un riesgo que podría causar lesiones personales graves si no se tiene en cuenta la ADVERTENCIA.
	Indica un riesgo potencial si no se tiene en cuenta la información indicada.
	Indica riesgo de descargas eléctricas que podrían causar lesiones graves o la muerte si no se siguen las instrucciones de seguridad.
	Indica componentes o superficies calientes.
	Indica que no se deben tocar las aspas de los ventiladores, ya que de lo contrario se podrían producir lesiones.
	Indica que es necesario desenchufar los cables de alimentación de CA para desconectar la alimentación de CA
	Recicle por favor la batería

Aplicaciones y usos previstos

Este producto ha sido evaluado como equipo de tecnología informática (ITE) que puede instalarse en oficinas, escuelas, salas de equipos informáticos o lugares de ámbito comercial similares. Es posible que sea necesario llevar a cabo una evaluación adicional para comprobar si este producto es apropiado para otras categorías de productos y entornos además de las aplicaciones informáticas (por ejemplo, soluciones médicas, industriales, residenciales, sistemas de alarma y equipos de pruebas).

Selección de la ubicación

El sistema se ha diseñado para funcionar en un entorno normal de oficinas. Seleccione una ubicación que esté:

- Limpia, seca y libre de macropartículas en suspensión en el aire (que no sean el polvo habitual de la habitación).
- Bien ventilada y alejada de fuentes de calor, incluida la luz solar directa y los radiadores.
- Alejada de fuentes de vibración o de golpes físicos.
- Aislada de campos electromagnéticos producidos por dispositivos eléctricos.

- En zonas propensas a tormentas eléctricas, se recomienda que conecte el servidor a un supresor de sobretensiones y desconecte las líneas de telecomunicaciones al módem durante una tormenta eléctrica.
- Provista de una toma de corriente alterna correctamente conectada a tierra.
- Provista de espacio suficiente para acceder a los cables de la fuente de alimentación ya que constituyen la desconexión principal de la alimentación.

Manipulación del equipo

Reduzca el riesgo de daños personales o en el equipo:

- Respete los requisitos de sanidad y seguridad laborales de su país cuando traslade y levante el equipo.
- Utilice medios mecánicos u otros que sean adecuados al trasladar o levantar el equipo.
- Para que el peso sea menor para manipularlo con más facilidad, extraiga los componentes que sean de fácil extracción.

Advertencias de alimentación y eléctricas

Precaución: *El botón de encendido, indicado con la marca del modo de reposo o stand-by, NO DESCONECTA completamente la alimentación de CA del sistema, ya que el modo de reposo de 5 V sigue activo mientras el sistema está enchufado. Para desconectar el sistema debe desenchufar el cable de alimentación de CA de la toma de la pared. Puede usar más de un cable de alimentación de CA con el sistema. Asegúrese de que todos los cables de alimentación de CA están desenchufados. Asegúrese de que los cables de alimentación de CA estén desenchufado antes de abrir le gabinete, agregar o extraer cualquier componente que no es de conexión en funcionamiento.*

Algunas fuentes de alimentación de electricidad de los servidores de Intel utilizan el polo neutral del fuselaje. Para evitar riesgos de choques eléctricos use precauciones al trabajar con las fuentes de alimentación que utilizan el polo neutral de fuselaje.

No intente modificar ni utilizar un cable de alimentación de CA si no es del tipo exacto requerido. Se necesita un cable de CA para cada fuente de alimentación del sistema.

La fuente de alimentación de este producto no contiene piezas que puedan ser reparadas por el usuario. No abra la fuente de alimentación. Dentro de la fuente de alimentación

puede haber niveles de tensión, corriente y energía peligrosos. Devuélvala al fabricante para repararla.

Al reemplazar una fuente de alimentación de conexión en funcionamiento, desenchufe el cable de alimentación de la fuente de alimentación que va a reemplazar antes de extraerla del servidor.

Para evitar el riesgo de descargas eléctricas, antes de abrir el servidor, apáguelo, desconecte el cable de alimentación, los sistemas de telecomunicaciones, las redes y los módems conectados al mismo.

Advertencias el acceso al sistema

Precaución: *Para evitar lesiones personales o daños en la propiedad, se aplican las siguientes instrucciones de seguridad siempre que se acceda al interior del producto:*

- *Apague todos los dispositivos periféricos conectados a este producto.*
- *Pulse el botón de alimentación para apagar el sistema.*
- *Desconecte la alimentación de CA desenchufando los cables de alimentación de CA del sistema o de la toma de corriente alterna.*
- *Desconecte todos los cables y líneas de telecomunicación que estén conectados al sistema.*
- *Guarde todos los tornillos o elementos de fijación cuando retire las cubiertas de acceso. Cuando termine de operar en el interior del producto, vuelva a colocar los tornillos o los elementos de fijación originales de la cubierta de acceso.*
- *No acceda al interior de la fuente de alimentación. No hay elementos en la fuente de alimentación que usted pueda reparar y utilizar. Devuélvala al fabricante para repararla.*
- *Apague el servidor y desconecte todos los cables de alimentación antes de agregar o reemplazar cualquier componente que no es de conexión en funcionamiento.*
- *Al reemplazar una fuente de alimentación de conexión en funcionamiento, desenchufe el cable de alimentación de la fuente de alimentación que va a reemplazar antes de extraerla del servidor.*

Precaución: *Si el servidor se ha estado ejecutando, los procesadores y disipadores de calor estarán recalentados. A no ser que esté instalando o extrayendo un componente de conexión en funcionamiento, deje que el sistema se enfríe antes de abrir las cubiertas. Para que no llegue a tocar los componentes que estén calientes cuando esté realizando una instalación*

de conexión en funcionamiento, tenga cuidado al extraer o instalar los componentes de conexión en funcionamiento.

Precaución: Para evitar posibles daños, no toque las aspas en movimiento de los ventiladores. Si el sistema se le ha suministrado con una protección para el ventilador, asegúrese de que cuando esté funcionando el sistema la protección esté en su sitio.

Descarga electrostática (ESD)

Precaución: Las descargas electrostáticas pueden dañar las unidades de disco, las tarjetas y otros componentes. Recomendamos que realice todos los procedimientos en una estación de trabajo protegida contra descargas electrostáticas. En caso de que no haya una disponible, protéjase de alguna forma contra las descargas llevando un brazalete antiestático conectado a la toma de tierra de la carcasa (cualquier superficie de metal que no esté pintada) del servidor cuando manipule las piezas.

Manipule siempre las tarjetas con el máximo cuidado. Pueden ser sumamente sensibles a las descargas electrostáticas. Sujételas sólo por los bordes. Una vez extraída la tarjeta de su envoltorio de protección o del servidor, colóquela con el lado de los componentes hacia arriba sobre una superficie con toma de tierra y sin carga estática. Utilice una almohadilla de espuma conductora si dispone de ella, pero nunca el envoltorio de la tarjeta. No deslice la tarjeta sobre ninguna superficie.

Otros peligros

Sustitución de la batería

Precaución: Existe el peligro de explosión si la batería no se reemplaza correctamente. Al reemplazar la batería, utilice sólo la batería recomendada por el fabricante del equipo.

Deseche las baterías respetando la normativa local.

No intente recargar la batería.

No intente desmontar, pinchar o causar cualquier otro desperfecto a una batería.

Enfriamiento y circulación de aire

Precaución: El tendido de los cables debe realizarse cuidadosamente tal y como se le indica para reducir al mínimo los problemas de obstrucción de la ventilación y de refrigeración.

Para conseguir una refrigeración y corriente de aire adecuadas, compruebe que cuando sistema esté funcionando, las cubiertas de la carcasa están instaladas. Si utiliza el sistema sin las cubiertas, podría dañar sus componentes. Para instalar las cubiertas:

- Compruebe primero que no ha dejado herramientas o piezas sueltas dentro del sistema.
- Compruebe que los cables, tarjetas adicionales y otros componentes están instalados correctamente.
- Sujete las cubiertas a la carcasa siguiendo las instrucciones del producto.

Periféricos o dispositivos láser

Precaución: Para evitar el riesgo de la exposición a radiaciones o de daños personales:

- No abra la caja de ningún periférico o dispositivo láser
- Los periféricos o dispositivos láser no pueden ser reparados por el usuario
- Haga que el fabricante los repare.

简体中文

服务器安全信息

本文档适用于 Intel® 服务器主板、Intel® 服务器机箱（基座和机架固定件）和已安装的外设。为减少人身伤害、电击、火灾以及设备毁坏的危险，请在安装或维护 Intel® 服务器产品之前阅读本文档并遵循本指南中的所有警告和预防措施。





如果本文档中的信息与特定产品的随附信息或 Web 站点信息之间存在不一致，请以产品文档为准。

服务器须由合格的技术人员进行集成和维护。

必须遵守本指南的规定和服务器手册的装配指导，以确保符合现有的产品认证和审批。仅使用本指南中描述和规定的指定组件。使用其他产品 / 组件将使产品的 UL 认证和其他管理审批无效，并可能导致产品不符合销售地的产品法规。

安全警告与注意事项

为避免人身伤害与财产损失，安装本产品之前，请阅读以下所有安全指导和信息。下面所列的安全符号可能在整个文档中使用并可能标注于产品和 / 或产品包装之上。

注意	表示如果无视此“注意事项”，存在可能引起轻微人身伤害或财产损失的危险。
警告	表示如果无视此“警告”，存在可能引起严重人身伤害的危险。
	表示如果无视所示信息，即存在潜在的危险。
	表示如果不遵守安全指导，存在可导致严重伤害或死亡的电击危险。
	表示灼热组件或表面。
	表示请勿触摸风机叶片，否则可能致伤。
	表示拔下所有交流电线，断开交流电源

预期应用使用

根据评估，本产品为信息技术设备 (ITE)，可安装在办公室、学校、计算机房和类似的商业场所。本产品对于非 ITE 应用的其他产品种类和环境（如医疗、工业、住宅、报警系统和测试设备）的适用性尚有待进一步的评估。

场地选择

本系统专为在典型办公环境运行而设计。请选择符合以下条件的地点：

- 清洁、干燥，无气载微粒（而非一般的室内尘埃）。
- 通风良好，远离热源（包括直接日晒和散热器）。
- 远离振动源或物理震动。
- 与电气设备产生的强大电磁场隔离。
- 在易受闪电袭击的地区，我们建议将系统插入电涌抑制器并在闪电期间断开通信线路与调制解调器之间的连接。
- 提供正确接地的墙壁插座。
- 提供足够的空间，以便拿取电源供应线，因为这是本产品的主要电源断开器。

设备操作规范

减少人身伤害或设备受损的危险：

- 移举设备时遵守当地的职业健康与安全要求。
- 借助机械手段或其他合适的手段移举设备。
- 拆除一切易分离组件，以降低重量并方便操作。

电源与电气警告



⚠ 注意事项

电源按钮（如待机电源标记所示）并不能完全关闭系统的交流电源，只要系统已接通电源，就存在 5V

待机电源。要从系统切断电源，须从墙壁电源插座中拔下交流电线。您的系统可能不止使用一根交流电线。请确保所有的交流电线都已拔下。打开机箱或增加或去除任何热插拔组件之前，确保交流电线已拔下。

若非所需的确切类型，请勿尝试修改或使用交流电线。系统的每个电源供应设备都需要一根单独的交流电线。

本产品的电源供应设备包含非用户维修部件。请勿打开电源供应设备。电源供应设备包含非常危险的电压级、电流级和能量级。请与生产商联系维修事宜。

替换热插拔电源供应设备时，请先拔下需替换的电源供应设备上的电源线，再将其从服务器上移除。

为避免电击，请在打开服务器之前，关闭服务器并断开服务器上连接的电源线、电信系统、网络 and 调制解调器。

系统使用警告



⚠ 注意事项

为避免人身伤害或财产损失，无论何时检查产品内部，以下安全指导都适用：

- 关闭所有与本产品相连的外设。
- 按下电源按钮至关闭状态，关闭系统。
- 从系统或墙壁插座上拔下所有交流电线，断开交流电源。
- 断开与系统相连的所有线缆和通信线路。
- 卸除舱口盖时，保留所有螺钉及其他紧固件。完成产品内部检查之后，请用螺钉或紧固件重新固定舱口盖。
- 请勿打开电源供应设备。电源供应设备内设有可维修部件，请与生产商联系维修事宜。
- 增加或替换任何非热插拔组件之前，请关闭服务器电源并断开所有电源线。
- 替换热插拔电源供应设备时，请先拔下需替换的电源供应设备上的电源线，然后再从服务器上移除电源供应设备。



⚠ 注意事项

如果服务器一直在运行，任何已安装的处理器和散热设备都可能很热。除非要增加或移除热插拔组件，否则请待系统冷却后再开盖。为避免在热插拔组件安装过程中接触灼热组件，移除或安装热插拔组件时必须小心。



⚠ 注意事项

为避免受伤，请勿触摸运转的风机叶片。如果系统的风机上配有防护装置，请勿卸下风机防护装置运行系统。

静电放电 (ESD)



⚠️ 注意事项

ESD 会损坏磁盘驱动器、主板及其他部件。我们建议您执行 ESD 工作站的所有步骤。如果没有 ESD 工作站，则采取一些静电放电保护措施：操作部件时，戴上与服务器上的机箱接地或任何无喷漆金属表面连接的防静电腕带。

操作主板时始终保持小心。它们可能对 ESD 非常敏感。拿持主板时只接触边缘。从保护包装中或从服务器上取出主板后，请将主板组件侧面朝上放置于无静电的接地表面上。请使用导电泡沫垫（若有），不要使用主板包装。请勿将主板在任何表面上滑动。

其他危险

替换电池



⚠️ 注意事项

不正确替换电池可能导致爆炸危险。替换电池时，请只使用设备生产商推荐使用的电池。

请按当地法规处置电池。

请勿对电池充电。

请勿拆卸、刺穿或以其他方式损坏电池。

冷却和气流



⚠️ 注意事项

按照说明小心布置线缆，尽量减少气流阻塞和冷却问题。

为保证适当的冷却和气流，运行系统时请确保机箱盖已安装。未安装机箱盖即运行系统可能导致系统部件受损。安装机箱盖的步骤如下：

- 首先检查并确保系统内没有遗留的未固定工具或部件。
- 检查线缆、内插板和其他组件已正确安装。
- 按产品说明安装机箱盖。

激光外设或激光设备



注意事项

为避免幅射暴露和 / 或人身伤害:

- 请勿打开任何激光外设或激光设备的外壳
- 激光外设或激光设备为非用户维修设备

请与生产商联系维修事宜

