



Intel[®] Server System SR2612UR

Technical Product Specification



Intel order number E76293-003

Revision 1.3

April 2010

Enterprise Platforms and Services Division

Revision History

Date	Revision Number	Modifications
July 2009	1.0	Initial Release.
July 2009	1.1	Updated Regulatory and Certification Information and Added PMBus Information.
November 2009	1.2	Updated section 4.5 with correct SATA HDD support information.
April 2010	1.3	Updated Section 5.2.1 Hard Drive Activity and Fault LEDs. Removed CCC certification in section 10.

Disclaimers

Information in this document is provided in connection with Intel® products. No license, express or implied, by estoppel or otherwise, to any intellectual property rights is granted by this document. Except as provided in Intel's Terms and Conditions of Sale for such products, Intel assumes no liability whatsoever, and Intel disclaims any express or implied warranty, relating to sale and/or use of Intel products including liability or warranties relating to fitness for a particular purpose, merchantability, or infringement of any patent, copyright or other intellectual property right. Intel products are not intended for use in medical, life saving, or life sustaining applications. Intel may make changes to specifications and product descriptions at any time, without notice.

Designers must not rely on the absence or characteristics of any features or instructions marked "reserved" or "undefined." Intel reserves these for future definition and shall have no responsibility whatsoever for conflicts or incompatibilities arising from future changes to them.

The Intel® Server System SR2612UR may contain design defects or errors known as errata which may cause the product to deviate from published specifications. Current characterized errata are available on request.

This document and the software described in it are furnished under license and may only be used or copied in accordance with the terms of the license. The information in this manual is furnished for informational use only, is subject to change without notice, and should not be construed as a commitment by Intel Corporation. Intel Corporation assumes no responsibility or liability for any errors or inaccuracies that may appear in this document or any software that may be provided in association with this document.

Except as permitted by such license, no part of this document may be reproduced, stored in a retrieval system, or transmitted in any form or by any means without the express written consent of Intel Corporation.

Intel, Pentium, Itanium, and Xeon are trademarks or registered trademarks of Intel Corporation.

*Other brands and names may be claimed as the property of others.

Copyright © Intel Corporation 2010.

Table of Contents

1. Introduction	1
1.1 Chapter Outline	1
1.2 Server Board Use Disclaimer	1
2. Product Overview	2
2.1.1 Processor Support	3
2.2 System Overview	6
2.3 System Dimensions	6
2.4 System Components	8
2.5 Hard Drive and Peripheral Bays	10
2.6 System Board Overview	12
2.7 Rack and Cabinet Mounting Options	15
3. Power Subsystem.....	16
3.1 Mechanical Overview	17
3.2 Handle and Retention Mechanism.....	18
3.3 Hot-swap Support	18
3.4 Airflow	18
3.5 AC Power Cord Specification Requirements	18
3.6 Output Connectors	19
3.6.1 P1 – Power Signal Connector	19
3.6.2 P2 – Server Board Power Connector	19
3.6.3 P3 – Processor and Memory Power Connector.....	20
3.6.4 P4 – Backplane Power Connector.....	20
3.6.5 P5 and P6– Auxiliary Baseboard Power Connector.....	21
3.6.6 P7, P8 and P9 – SATA/Peripheral Power Connector	21
3.7 AC Input Requirements.....	21
3.7.1 Efficiency.....	21
3.7.2 AC Input Voltage Specification	21
3.7.3 AC Line Dropout/Holdup	22
3.7.4 AC Inrush	22
3.8 Protection Circuits	22
3.8.1 Over-current Protection (OCP).....	22

3.8.2	Over-voltage Protection (OVP).....	23
3.8.3	Over-temperature Protection (OTP)	23
3.9	DC Output Specification	24
3.9.1	Output Power/Currents	24
3.9.2	Standby Output/Standby Mode	24
3.10	PMBus™	24
3.10.1	Hardware	24
3.10.2	Data Format	25
3.10.3	Monitoring power/current/voltage	25
3.10.4	Thermal Management	25
3.10.5	Capability and inventory reporting	26
3.11	Power Supply Status LED	26
4.	Cooling Subsystem	27
4.1	Airflow paths	27
4.2	System Fan Module	28
4.3	Airflow Support.....	30
4.4	Drive Bay Population.....	30
4.5	Sata HDD Support	31
5.	System Board Interconnects	32
5.1	Active SAS Midplane.....	32
5.2	Hot-swap SAS/SATA Backplane	33
5.2.1	Hard Drive Activity and Fault LEDs	35
5.3	Remote RAID Controller Battery Backup Unit Mount.....	37
6.	Peripheral and Hard Drive Subsystem.....	38
6.1	Slimline Optical Drive Bay	39
6.2	Hard Drive Bays	39
6.2.1	Hot-swap Drive Carriers	39
7.	Control Panel.....	41
7.1	Front LED Panel.....	41
7.2	Rear Control Panel.....	42
7.3	System Status LED	42
7.4	System Identification LED	43
8.	PCI Riser Cards and Assembly	44
8.1	Riser Card Options.....	45

8.2	PCI Riser Card Mechanical Drawings	46
9.	Environmental Specifications	49
9.1	System Level Environmental Limits	49
9.2	Serviceability and Availability	49
9.3	Replacing the Backup Battery	49
10.	Regulatory and Certification Information	51
10.1	Product Regulatory Compliance	51
10.1.1	Product Safety Compliance	51
10.1.2	Product EMC Compliance – Class A Compliance	52
10.1.3	Product Ecology Compliance	52
10.1.4	Certifications/Registrations/Declarations	53
10.2	Product Regulatory Compliance Markings	53
10.3	Rack Mount Installation Guidelines	56
10.4	Power Cord Usage Guidelines	57
10.5	Electromagnetic Compatibility Notices	57
10.5.1	FCC Verification Statement (USA)	57
10.5.2	ICES-003 (Canada)	58
10.5.3	Europe (CE Declaration of Conformity)	59
10.5.4	VCCI (Japan)	59
10.5.5	BSMI (Taiwan)	59
10.5.6	KCC (Korea)	59
10.6	Regulated Specified Components	60
	Appendix A: Integration and Usage Tips	61
	Appendix B: POST Code Diagnostic LED Decoder	62
	Appendix C: POST Code Errors	66
	Glossary	71
	Reference Documents	73

List of Figures

Figure 1. Top Down View.....	6
Figure 2. System Width	7
Figure 3. System Length.....	7
Figure 4. Major System Components (1 of 2).....	8
Figure 5. Major System Components (2 of 2).....	9
Figure 6. Drive Bay Overview.....	10
Figure 7. Intel® Server Board S5520UR	12
Figure 8. Intel® Server Board S5520UR Components	13
Figure 9. Back Panel Feature Overview.....	14
Figure 10. Intel® Light-Guided Diagnostic LEDs - Server Board.....	15
Figure 11. Power Supply Module	16
Figure 12. Power Distribution Module	16
Figure 13. Mechanical Drawing for Power Supply Module	17
Figure 14. Mechanical Drawing for Power Distribution Module	17
Figure 15. Airflow Paths.....	28
Figure 16. Non-redundant Fan Module	29
Figure 17. CPU / Memory Air Duct.....	30
Figure 18. 3.5-inch Drive Carrier with a Blank.....	31
Figure 19. Active SAS Midplane Board	32
Figure 20. 3.5-inch Hot-swap SAS/SATA Backplane (Front Side View)	34
Figure 21. 3.5-inch Hot-swap SAS/SATA Backplane (Back Side View)	34
Figure 22. Remote RAID BBU Mount.....	37
Figure 23. Drive Bay Overview.....	39
Figure 24. Slimline Optical Drive Assembly.....	39
Figure 25. 3.5-inch Hard Drive Tray Assembly.....	40
Figure 26. Front LED Panel	41
Figure 27. Rear Control Panel	42
Figure 28. 2U Riser Assembly	44
Figure 29. 2U PCI Express* Passive Riser	45
Figure 30. 2U PCI Express* Passive Riser – Primary Side	46
Figure 31. 2U PCI Express* Passive Riser – Secondary Side.....	47
Figure 32. 2U Butterfly PCI Express* Active Riser – Primary Side.....	48

Figure 33. 2U Butterfly PCI Express* Active Riser – Secondary Side48
Figure 34. Diagnostic LED Placement Diagram62

List of Tables

Table 1. System Feature Set	2
Table 2. Mixed Processor Configurations.....	4
Table 3. System Dimensions	6
Table 4. Drive Overview.....	11
Table 5. Major Board Components	14
Table 6. AC Power Cord Specifications	18
Table 7. Power Harness Cable Definitions.....	19
Table 8. P1 Power Signal Connector	19
Table 9. P2 Main Power Connector	20
Table 10. P3 Processor/Memory Power Connector	20
Table 11. P4 Backplane Power Connector.....	20
Table 12. P5 and P6 Auxiliary Baseboard Power Connector.....	21
Table 13. P7, P8, and P9 SATA/Peripheral Power.....	21
Table 14. Efficiency.....	21
Table 15. AC Input Rating.....	22
Table 16. Over-current Protection Limits / 240 VA Protection	23
Table 17. Over-voltage Protection (OVP) Limits	23
Table 18. Output Power and Current Ratings	24
Table 19. LED Indicators	26
Table 20. Non-redundant Fan Connector Pin Assingment	30
Table 21. Non-redundant Cooling Zones	30
Table 22. SAS Connector Pin-out (J2).....	33
Table 23. Motherboard to Backplane GPIO Pin-out (J20)	34
Table 24. Backplane Power Supply Pin-out (J23)	35
Table 25. SAS/SATA Hard Drive Connector Pin-outs (J1, J2, ..., J12)	35
Table 26. Hard Drive LED Function Definitions	36
Table 27. Front LED Panel Definition.....	41
Table 28. Rear Control Panel Functions	42
Table 29. Control Panel LED Operation.....	42
Table 30. Riser Card Options.....	45
Table 31. System Environmental Limits Summary	49

Table 32. Time Estimate for System Maintenance Procedures.....49

Table 33. POST Progress Code LED Example.....62

Table 34. Diagnostic LED POST Code Decoder.....63

Table 35. POST Error Messages and Handling66

Table 36. POST Error Beep Codes.....69

Table 37. Integrated BMC Beep Codes70

1. Introduction

This Technical Product Specification (TPS) provides system-specific information detailing the features, functionality, and high-level architecture of the Intel® Server System SR2612UR. You can also reference the *Intel® Server Board S5520UR Technical Product Specification* to obtain greater detail of functionality and architecture specific to the integrated server board and learn about what is supported on this server system.

In addition, you can obtain design-level information for specific subsystems by ordering the External Product Specifications (EPS) or External Design Specifications (EDS) for a given subsystem. EPS and EDS documents are not publicly available. They are only made available under NDA with Intel and must be ordered through your local Intel representative. Refer to the *Reference Documents* section at the end of this document for a complete list of available documents.

The Intel® Server System SR2612UR may contain design defects or errors known as errata, which may cause the product to deviate from published specifications. Refer to the *Intel® Server Board S5520UR/Intel® Server System SR2612UR Specification Update* for published errata.

1.1 Chapter Outline

This document is divided into the following chapters:

- Chapter 1 - Introduction
- Chapter 2 - Product Overview
- Chapter 3 - Power Subsystem
- Chapter 4 - Cooling Subsystem
- Chapter 5 - System Board Interconnects
- Chapter 6 – Peripheral and Hard Drive Support
- Chapter 7 - Control Panel
- Chapter 8 - PCI Riser Cards and Assembly
- Chapter 9 - Environmental Specifications
- Chapter 10 - Regulatory and Certification Information
- Appendix A: Integration and Usage Tips
- Appendix B: POST Code Diagnostic LED Decoder
- Appendix C: POST Code Errors
- Glossary
- Reference Documents

1.2 Server Board Use Disclaimer

Intel Corporation server boards support add-in peripherals and contain a number of high-density VLSI and power delivery components that need adequate airflow to cool. Intel ensures through its own system development and testing that when Intel server building blocks are used together, the fully integrated system will meet the intended thermal requirements of these components. It is the responsibility of the system integrator who chooses not to use Intel-developed server building blocks to consult vendor datasheets and operating parameters to determine the amount of air flow required for their specific application and environmental conditions. Intel Corporation cannot be held responsible if components fail or the server board does not operate correctly when used outside any of their published operating or non-operating limits.

2. Product Overview

The Intel® Server System SR2612UR is a rack mount 2U server system integrated with an Intel® Server Board S5520UR with features designed to support the high-density high performance computing server market.

This chapter provides a high-level overview of the system features. The following chapters provide greater detail for each major system component or feature.

Table 1. System Feature Set

Feature	Description
Peripheral Interfaces	<p>External connections:</p> <ul style="list-style-type: none"> ▪ DB-15 video connector (back) ▪ RJ-45 serial Port A connector ▪ Two RJ-45 10/100/1000 Mb network connections ▪ Four USB 2.0 connectors (back) <p>Internal connections:</p> <ul style="list-style-type: none"> ▪ One USB 2x5 pin header, which supports two USB 2.0 ports ▪ One low-profile USB 2x5 pin header to support low-profile USB Solid State drives ▪ One DH-10 Serial Port B header ▪ Six Serial ATA (SATA) II connectors ▪ Two I/O module connectors ▪ One RMM3/GCM4 connector to support optional Intel® Remote Management Module 3 ▪ SATA Software 5 Activation Key connector ▪ One SSI-EEB compliant front panel header ▪ One SSI-EEB compliant 24-pin main power connector ▪ One SSI-compliant 8-pin CPU power connector ▪ One SSI-compliant auxiliary power connector
Video	<p>On-board ServerEngines* LLC Pilot II Controller</p> <ul style="list-style-type: none"> ▪ Integrated 2D Video Controller ▪ 8 MB DDR2 Memory
LAN	Two 10/100/1000 Intel® 82575 PHYs
Expansion Capabilities	Three full-height PCI Express* slots (passive) through a riser card
Hard Drive Options	<ul style="list-style-type: none"> ▪ 12, 3.5-inch hot-swap 3Gbps SATA / SAS hard drives. Two optional 2.5-inch fixed 3Gbps SATA hard drives (inside chassis).
Peripherals	<ul style="list-style-type: none"> ▪ Slimline bay for slimline SATA optical drive (back) ▪ PCI riser card bracket
Control Panel	<p>Standard control panel provides:</p> <ul style="list-style-type: none"> ▪ LEDs (front and back) ▪ Power switch (back)

Feature	Description
LEDs and displays	<ul style="list-style-type: none"> ▪ Power LED ▪ Standby Power LED (+3.3V Standby) ▪ System Status ▪ System Identification ▪ Enclosure Subsystem Fault ▪ Hard Drive Activity ▪ Hard Drive Status <p>Intel® Light-Guided diagnostics:</p> <ul style="list-style-type: none"> ▪ Fan Fault ▪ DIMM Fault ▪ CPU Fault ▪ 5V-Standby ▪ System Status ▪ System Identification ▪ POST Code Diagnostics
Power Supply	Up to two 760-W power supply modules
Fans	<ul style="list-style-type: none"> ▪ Non-redundant fan option containing four system fans ▪ Non-redundant fan in each power supply module
System Management	<p>On-board ServerEngines* LLC Pilot II Controller</p> <ul style="list-style-type: none"> ▪ Integrated Baseboard Management Controller (Integrated BMC), IPMI 2.0 compliant ▪ Integrated Super I/O on LPC interface <p>Support for Intel® System Management Software 3.1</p>

2.1.1 Processor Support

The server board supports the following processors:

- One or two Intel® Xeon® Processor 5500 Series with a 4.8 GT/s, 5.86 GT/s, or 6.4 GT/s Intel® QPI link interface.
- Up to 95-W Thermal Design Power (TDP); processors having higher TDP are not supported.

This server board does not support previous generations of the Intel® Xeon® processors.

For a complete updated list of supported processors, see:

<http://www.intel.com/support/motherboards/server/SR2612UR/>

On the Support tab, look for **Compatibility** and then **Supported Processor List**.

2.1.1.1 Processor Population Rules

Note: Although the server board does support dual-processor configurations consisting of different processors that meet the following defined criteria, Intel does not perform validation testing of this configuration. For optimal system performance in dual-processor configurations, Intel recommends the installation of identical processors.

When using a single processor configuration, you must install the processor into the processor socket labeled CPU1. A terminator is not required in the second processor socket when using a single processor configuration.

When two processors are installed, the following population rules apply:

- Both processors must be of the same processor family.
- Both processors must have the same front-side bus (FSB) speed.
- Both processors must have the same cache size.
- Processors with different speeds can be mixed in a system, given the prior rules are met. If this condition is detected, all processor speeds are set to the lowest common denominator (highest common speed) and an error is reported.
- Processor stepping within a common processor family can be mixed as long as it is listed in the processor specification updates published by Intel Corporation.

The following table describes mixed processor conditions and recommended actions for all Intel® server boards and systems that use the Intel® 5520 Chipset. The errors fall into one of the following two categories:

- **Fatal:** If the system can boot, it goes directly to the error manager, regardless of whether the “Post Error Pause” setup option is enabled or disabled.
- **Major:** If the “Post Error Pause” setup option is enabled, the system goes directly to the error manager. Otherwise, the system continues to boot and no prompt is given for the error. The error is logged to the error manager.

Table 2. Mixed Processor Configurations

Error	Severity	System Action
Processor family not identical	Fatal	The BIOS detects the error condition and responds as follows: <ul style="list-style-type: none"> ▪ Logs the error into the system event log (SEL). ▪ Alerts the Integrated BMC of the configuration error with an IPMI command. ▪ Does not disable the processor. ▪ Displays “0194: Processor family mismatch detected” message in the error manager. ▪ Halts the system.
Processor cache not identical	Fatal	The BIOS detects the error condition and responds as follows: <ul style="list-style-type: none"> ▪ Logs the error into the SEL. ▪ Alerts the Integrated BMC of the configuration error with an IPMI command. ▪ Does not disable the processor. ▪ Displays “0192: Cache size mismatch detected” message in the error manager. ▪ Halts the system.

Error	Severity	System Action
Processor frequency (speed) not identical	Major	<p>The BIOS detects the error condition and responds as follows:</p> <ul style="list-style-type: none"> ▪ Adjusts all processor frequencies to lowest common denominator. ▪ Continues to boot the system successfully. <p>If the frequencies for all processors cannot be adjusted to be the same, then the BIOS:</p> <ul style="list-style-type: none"> ▪ Logs the error into the SEL. ▪ Displays “0197: Processor speeds mismatched” message in the error manager. ▪ Halts the system.
Processor microcode missing	Fatal	<p>The BIOS detects the error condition and responds as follows:</p> <ul style="list-style-type: none"> ▪ Logs the error into the SEL. ▪ Alerts the Integrated BMC of the configuration error with an IPMI command. ▪ Does not disable processor. ▪ Displays “816x: Processor 0x unable to apply microcode update” message in the error manager. ▪ Pauses the system for user intervention.
Processor Intel® QuickPath Interconnect speeds not identical	Halt	<p>The BIOS detects the error condition and responds as follows:</p> <ul style="list-style-type: none"> ▪ Logs the error into the system event log (SEL). ▪ Alerts the Integrated BMC of the configuration error with an IPMI command. ▪ Does not disable the processor. ▪ Displays “0195: Processor Front Side Bus speed mismatch detected” message in the error manager. ▪ Halts the system.

2.2 System Overview



Figure 1. Top Down View

2.3 System Dimensions

Table 3. System Dimensions

Height	87 mm	3.43 in
Width	446 mm	17.57 in
Depth Rack Mounting Surface to Rear IO/Tray Module Handle	781.5 mm	30.79 in
Depth Front Surface of Disk Drive to Rear IO/Tray Module Handle	812.4 mm	32.01 in
Maximum Weight	30.3 kg	67 lbs

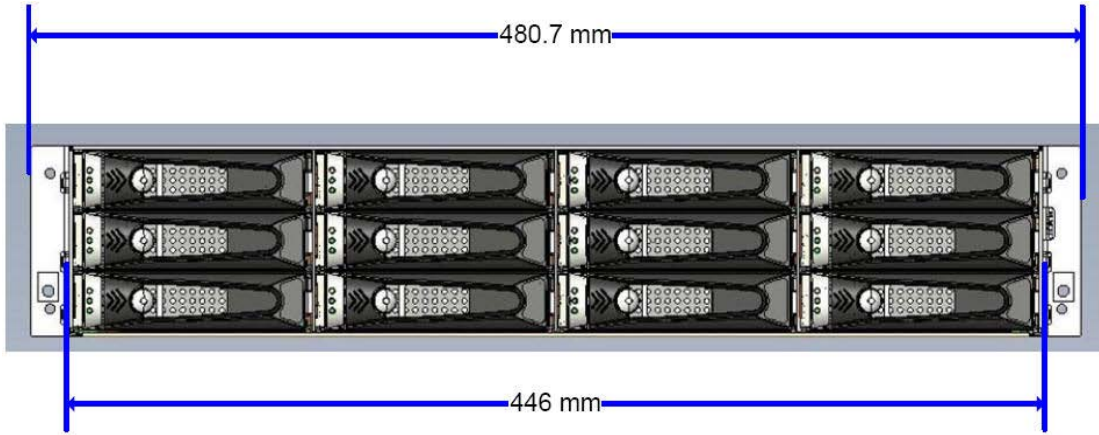

Figure 2. System Width

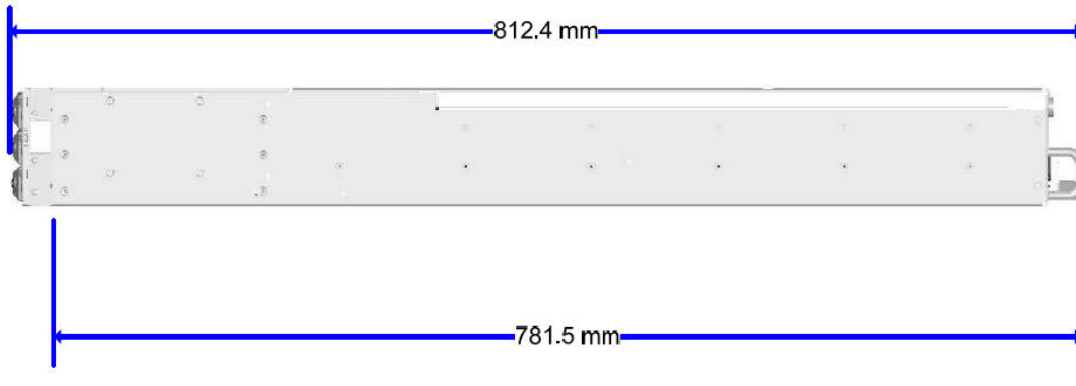
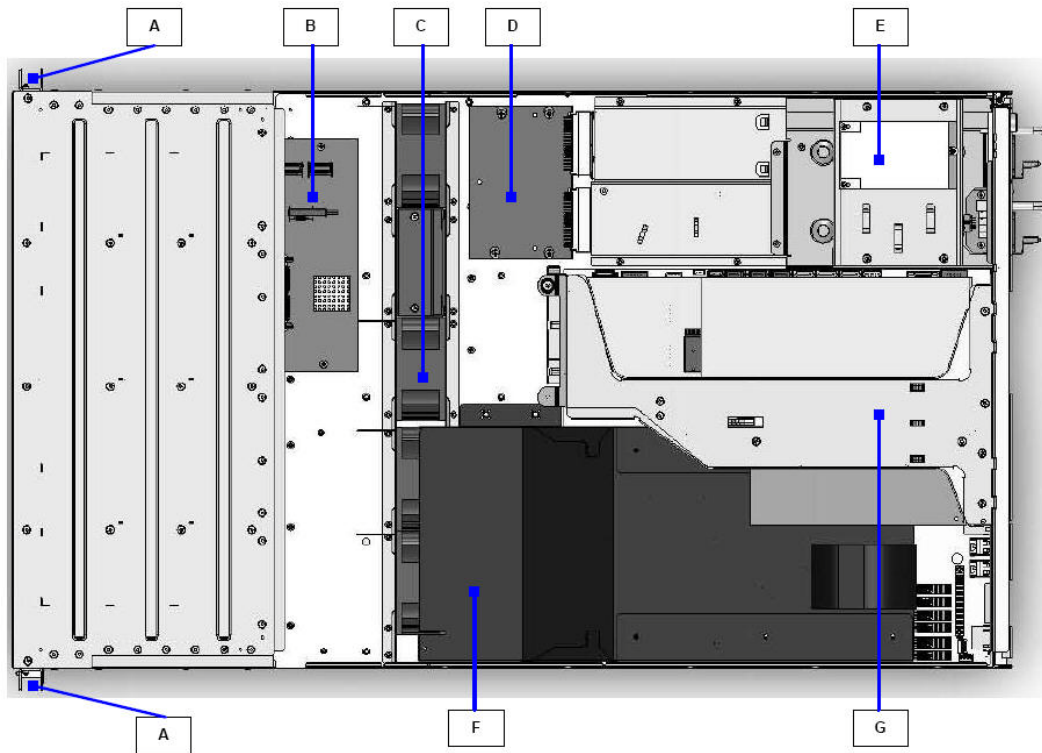

Figure 3. System Length

2.4 System Components



A.	Rack Mount Ears and Handles	E.	RAID Controller Card BBU (Optional)
B.	Active SAS Midplane	F.	CPU / Memory Air Duct
C.	System Fans Assembly	G.	PCI Riser Card Assembly
D.	Power Distribution Board		

Figure 4. Major System Components (1 of 2)

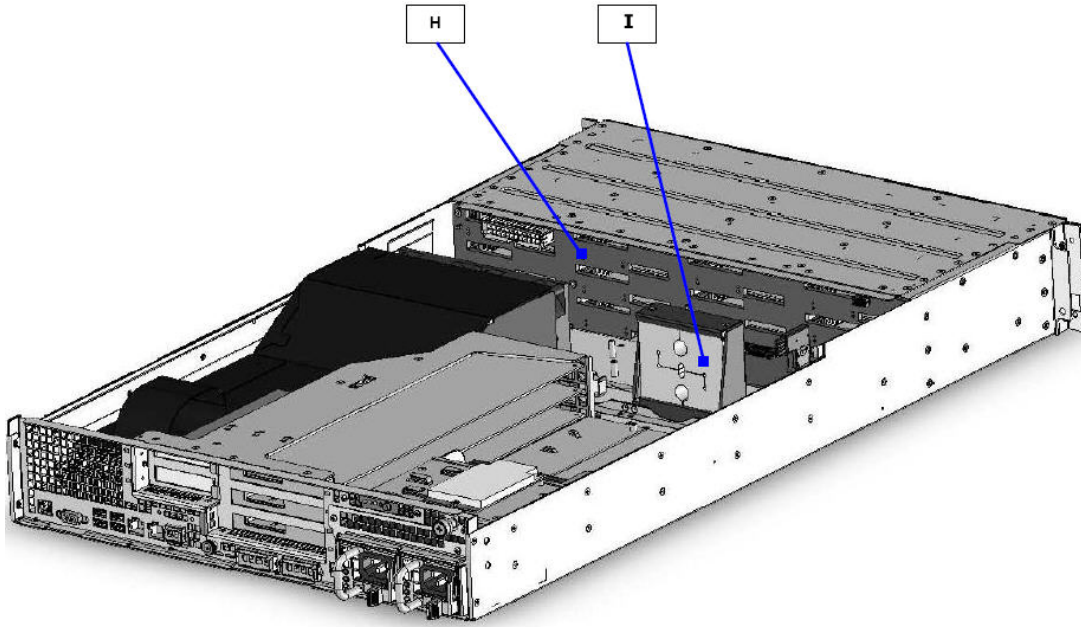

H.	Hot-swap SAS/SATA Hard Drive Backplane	I.	Cable Retention Assembly
----	--	----	--------------------------

Figure 5. Major System Components (2 of 2)

2.5 Hard Drive and Peripheral Bays

The system is designed to support several different hard drive and peripheral configurations. The system includes a hot-swap twelve-bay backplane capable of supporting either SAS or SATA drives. You can optionally configure the internal 2.5-inch SATA hard drive bay to support two fixed 2.5-inch hard drives.

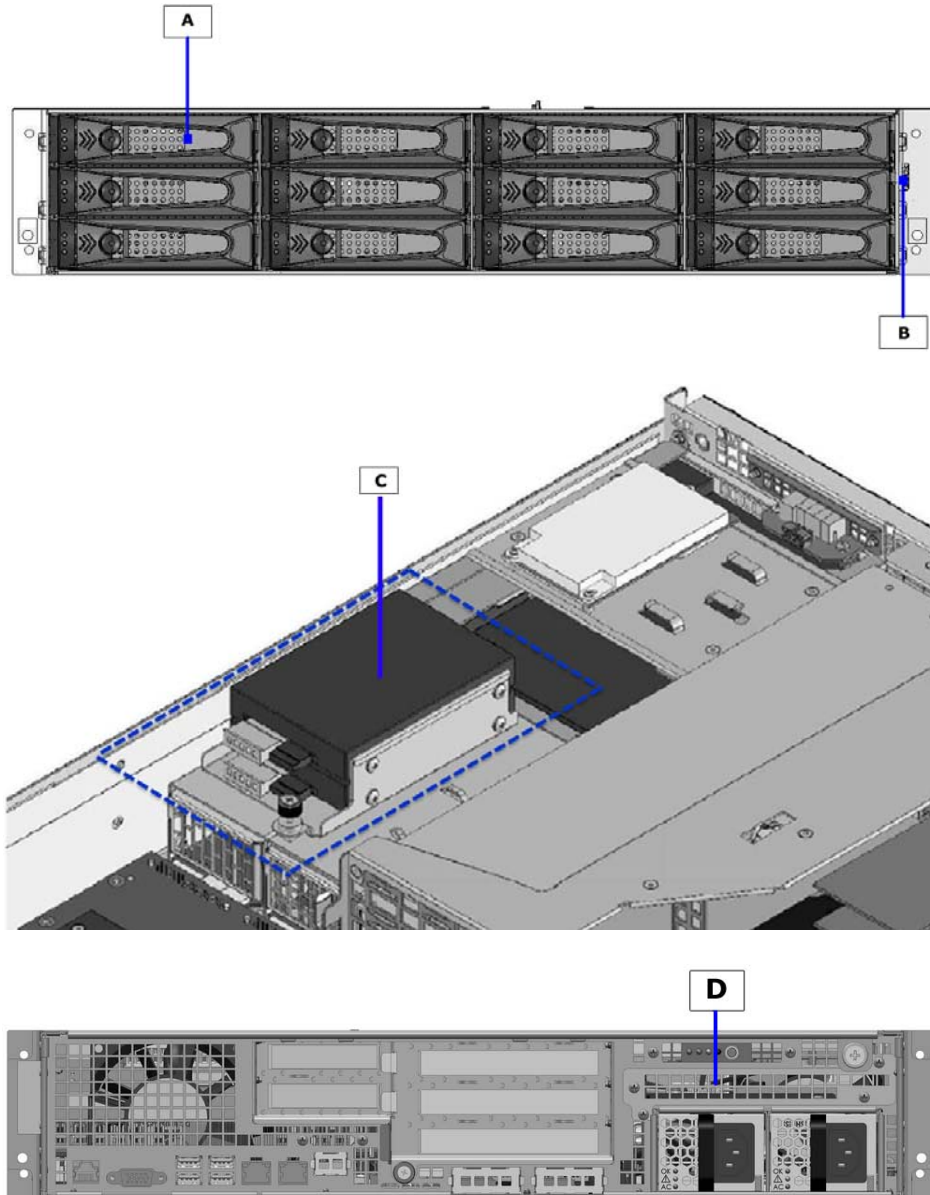

A.	Hot-swap 3.5-inch Hard Drive Bays (12)
B.	Front LEDs Board
C.	Internal fixed 2.5-inch SATA Hard Drive Bays (2)
D.	Slimline SATA Optical Drive Bay (1)

Figure 6. Drive Bay Overview

Table 4. Drive Overview

	Product Code – SR2612UR
Slimline SATA Optical Drive	Supported
Slimline USB Floppy Drive	Not Supported
SATA Drives	Up to 12 hot-swap 3.5-inch drives plus two fixed 2.5-inch drives inside chassis
SAS Drives	Up to 12 hot-swap 3.5-inch drives

2.6 System Board Overview



Figure 7. Intel® Server Board S5520UR

The following figure shows the board layout of the server board. Each connector and major component is identified by a number or letter, and a description is given below the figure.

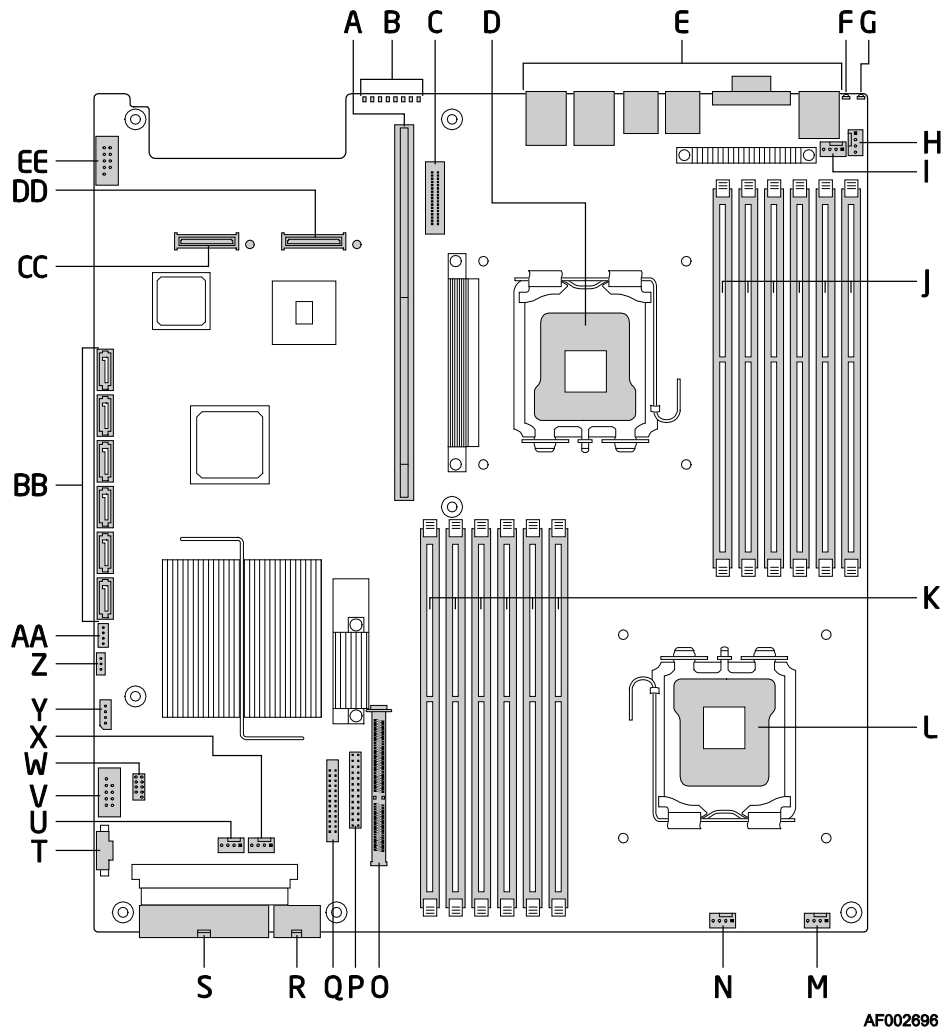
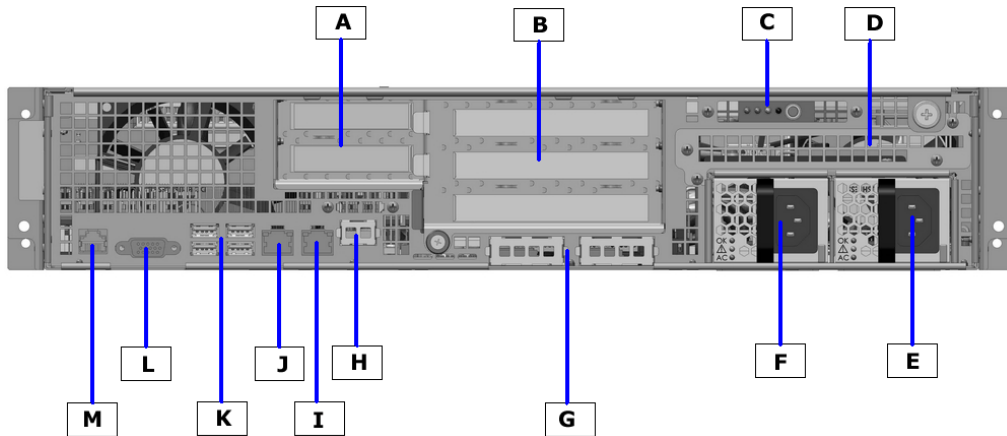

Figure 8. Intel® Server Board S5520UR Components

Table 5. Major Board Components

Description		Description	
A	280-pin Intel® Adaptive Riser Card Slot	Q	Fan Board Connector (Intel® Server Chassis)
B	POST Code LEDs	R	2x4 Power Connector
C	Intel® RMM3 Header	S	Main Power Connector
D	Processor 1	T	Power Supply SMBus Connector
E	Back Panel I/O	U	Fan Header
F	ID LED	V	USB Header
G	System Status LED	W	Low-profile USB Solid State Driver Header
H	Fan Header	X	Fan Header
I	Fan Header	Y	LCP IPMB Header
J	Processor 1 DIMM Slots	Z	SATA RAID 5 Key Header
K	Processor 2 DIMM Slots	AA	SGPIO Header
L	Processor 2	BB	SATA Connectors
M	Fan Header	CC	I/O Module Mezzanine Connector 2
N	Fan Header	DD	I/O Module Mezzanine Connector 1
O	Bridge Board Connector (Intel® Server Chassis)	EE	Serial Port B Header
P	Front Panel Connector		



A.	Low-profile PCIe* Add-in Card Slots	H.	Intel® Remote Management Module 3 NIC Port (Optional)
B.	Full-height PCI Add-in Card Slots	I.	NIC 2
C.	Rear Control Panel	J.	NIC 1
D.	Slimline Optical Drive (Optional)	K.	USB
E.	Power Supply Module 1	L.	Video
F.	Power Supply Module 2	M.	RJ-45 Serial A Connector
G.	Intel® I/O Expansion Module (Optional)		

Figure 9. Back Panel Feature Overview

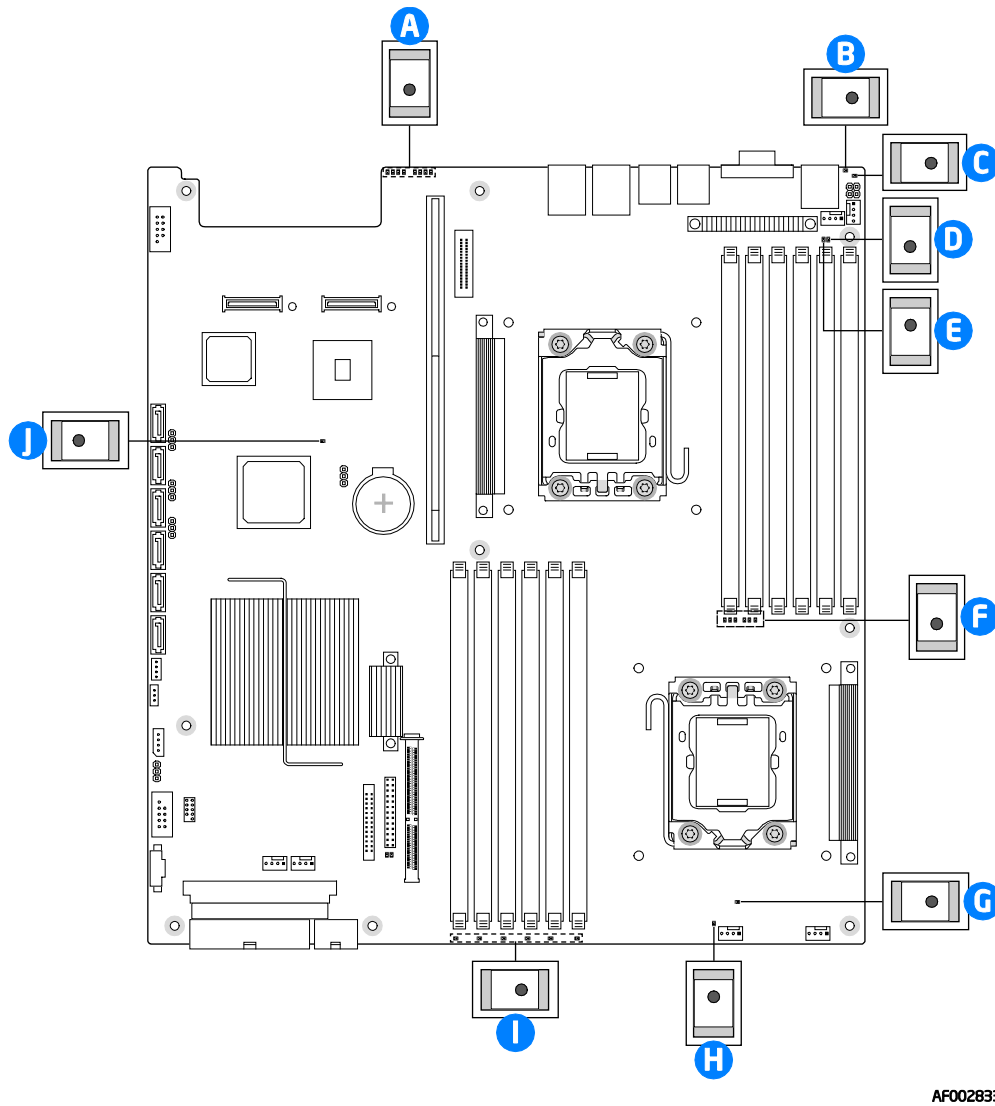

A	POST Code Diagnostic LEDs	F	CPU 1 DIMM Fault LEDs
B	System Identification LED	G	CPU 2 Fan Fault LED
C	Status LED	H	Memory 2 Fan Fault LED
D	Memory 1 Fan Fault LED	I	CPU 2 DIMM Fault LEDs
E	CPU 1 Fan Fault LED	J	5V Standby LED

Figure 10. Intel® Light-Guided Diagnostic LEDs - Server Board

2.7 Rack and Cabinet Mounting Options

The system is designed to support 19 inches wide by up to 34 inches deep server cabinets. The system supports following mount option:

- A fixed mount relay rack / cabinet mount kit designed to mount the system into a standard (19 inches by up to 34 inches deep) EIA-310D compatible server cabinet.

3. Power Subsystem

The power subsystem of the system consists of an integrated Power Distribution Module (PDM), power module enclosure, and support for up to two 760-Watt power supply modules. You can configure the power subsystem to support dual modules in a 1+1 redundant power configuration. In a 1+1 configuration, you can hot-swap a single failed power module with the system running.

This chapter provides technical details on the operation of the power supply module and power subsystem.



Figure 11. Power Supply Module

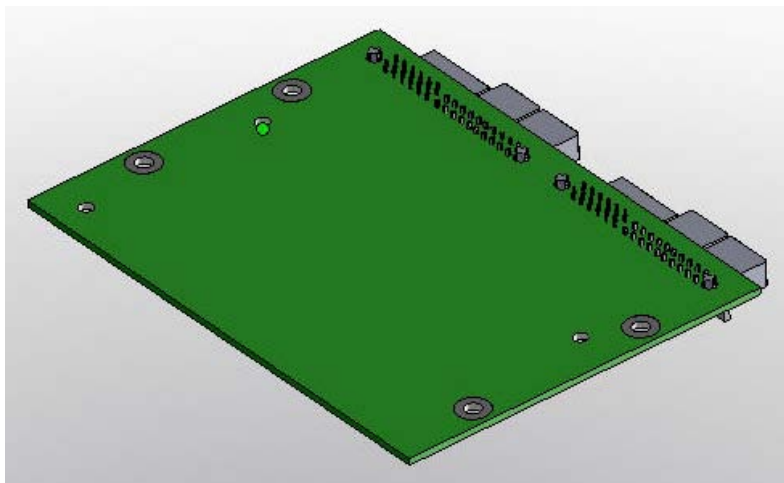

Figure 12. Power Distribution Module

3.1 Mechanical Overview

The following figures display the Power Distribution Module and the Power Supply Module dimensions.

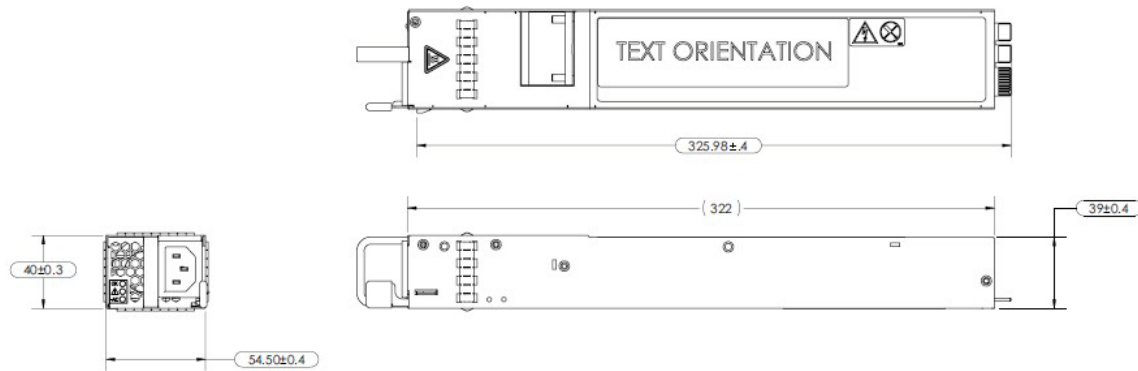

Figure 13. Mechanical Drawing for Power Supply Module

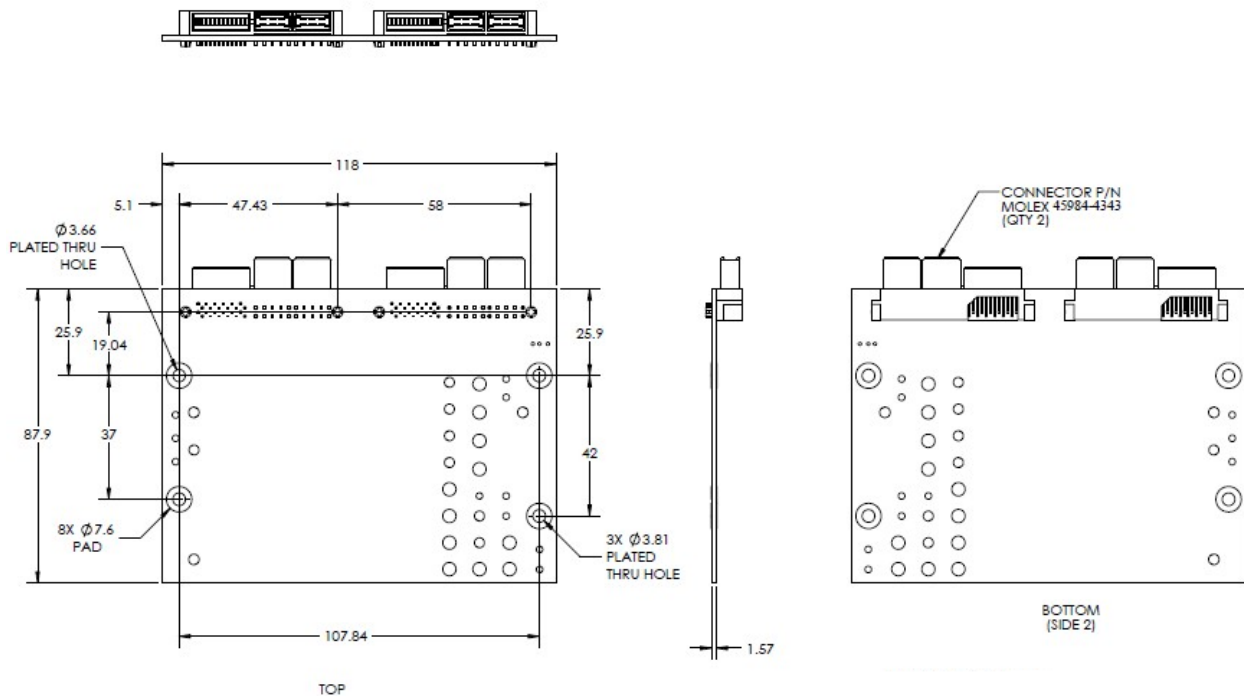

Figure 14. Mechanical Drawing for Power Distribution Module

3.2 Handle and Retention Mechanism

Each power supply module includes a handle for module insertion to or removal from the module enclosure. Each module has a simple retention mechanism to hold the power module in place once it is inserted. This mechanism withstands the specified platform mechanical shock and vibration requirements. The tab on the retention mechanism is colored green to indicate it is a hot-swap touch point. The latch mechanism is designed to prevent insertion or removal of the module when the power cord is plugged in. This aids the hot-swapping procedure.

3.3 Hot-swap Support

Hot-swapping a power supply module is the process of extracting and re-inserting a power supply module from an operating power system. During this process, the output voltages remain within specified limits. Up to two power supply modules may be on a single AC line. You can hot-swap the power supply module using the following procedure:

- **Extraction:** To remove the power supply, unplug the power cord first, and then remove the power module. You can do this in standby mode or power-on mode.
- **Insertion:** Insert the module first and then plug in the power cord. If the system is powered off, the system and the power supply will power on into standby mode or power-on mode.

3.4 Airflow

Each power supply module incorporates two non-redundant 40-mm fans for self-cooling and partial system cooling. The fans provide at least 10 CFM airflow through the power supply when installed in the system and operating at maximum fan speed. The cooling air enters the power module from the PDB side (pre-heated air from the system).

3.5 AC Power Cord Specification Requirements

The AC power cord used must meet the specification requirements listed in the following table.

Table 6. AC Power Cord Specifications

Cable Type	SJT
Wire Size	16 AWG
Temperature Rating	105°C
Amperage Rating	13 A
Voltage Rating	125 V

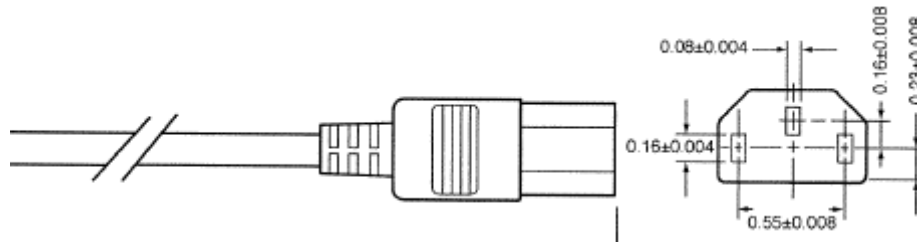

3.6 Output Connectors

The power distribution board provides a cable harness providing connectors to the various system boards. The harness size, connectors, and pin outs are shown in the following tables. Listed or recognized component appliance wiring material (AVLV2), CN, rated 105°C minimum, 300 VDC minimum is used for all output wiring.

Table 7. Power Harness Cable Definitions

Connector #	No of Pins	Description
P1	1x5	Server Board Signal Connector
P2	2x12	Main Power Connector to Server Board
P3	2x4	Processor and Memory Power Connector
P4	2x12	Backplane Power Connector
P5	2x2	Auxiliary Baseboard Power Connector 1
P6	2x2	Auxiliary Baseboard Power Connector 2
P7*	1x5	SATA Hard Disk Power Connector 1
P8*	1x5	SATA Hard Disk Power Connector 2
P9*	1x5	SATA Peripheral Power Connector

* These connectors are daisy-chained to one cable

3.6.1 P1 – Power Signal Connector

Connector housing: 5-pin Molex* 50-57-9405 or equivalent

Contact: Molex* 16-02-0088 or equivalent

Table 8. P1 Power Signal Connector

PIN	Signal	24 AWG Colors
1	SMBus Clock	White/Green Stripe
2	SMBus Data	White/Yellow Stripe
3	SMBAlert	White
4	ReturnS	Black/White Stripe
5	3.3RS	Orange/White Stripe

3.6.2 P2 – Server Board Power Connector

Connector housing: 24-pin Molex* Mini-Fit Jr. 39-01-2240 or equivalent

Contact: Molex Mini-Fit, HCS, Female, Crimp 44476 or equivalent

Table 9. P2 Main Power Connector

Pin	Signals	18 AWG Color	Pin	Signal	18 AWG Colors
1	+3.3 VDC	Orange	13	+3.3 VDC	Orange
2	+3.3 VDC	Orange	14	-12 VDC	Blue
3	COM (GND)	Black	15	COM	Black
4	5 VDC	Red	16	PS_ON#	Green
5	COM	Black	17	COM	Black
6	+5 VDC	Red	18	COM	Black
7	COM	Black	19	COM	Black
8	PWR OK	Gray	20	Reserved (-5 V in ATX)	N.C.
9	5 VSB	Purple	21	+5 VDC	Red
10	+12 V3	Yellow/Blue	22	+5 VDC	Red
11	+12 V3	Yellow/Blue	23	+5 VDC	Red
12	+3.3 VDC	Orange	24	COM	Black

3.6.3 P3 – Processor and Memory Power Connector

Connector housing: 8-pin Molex* 39-01-2080 or equivalent

Contact: Molex 45750-1111 or equivalent

Table 10. P3 Processor/Memory Power Connector

Pin	Signal	18 AWG Colors	Pin	Signal	18 AWG Colors
1	COM	Black	5	+12 V1	Yellow
2	COM	Black	6	+12 V1	Yellow
3	COM	Black	7	+12 V2	Yellow
4	COM	Black	8	+12 V2	Yellow

3.6.4 P4 – Backplane Power Connector

Connector housing: 24-pin Molex* 39-01-2240 or equivalent

Contact: Molex* 44476-1111 or equivalent

Table 11. P4 Backplane Power Connector

Pin	Signal	18 AWG Colors	Pin	Signal	18 AWG Colors
1	+3.3V	Orange	13	+3.3V	Orange
2	+3.3V	Orange	14	+12V	Yellow
3	GND	Black	15	GND	Black
4	+5V	Red	16	GND	Black
5	GND	Black	17	GND	Black
6	+5V	Red	18	GND	Black
7	GND	Black	19	GND	Black
8	+12V	Yellow	20	+12V	Yellow
9	+12V	Yellow	21	+5V	Red

10	+12V	Yellow	22	+5V	Red
11	+12V	Yellow	23	+5V	Red
12	+3.3V	Orange	24	GND	Black

3.6.5 P5 and P6– Auxiliary Baseboard Power Connector

Connector housing: 4-Pin Molex* 39-01-2040 or equivalent

Contact: Molex* 44476-1111 or equivalent

Table 12. P5 and P6 Auxiliary Baseboard Power Connector

Pin	Signal	18 AWG Colors	Pin	Signal	18 AWG Colors
1	COM	Black	3	+12V	Yellow
2	COM	Black	4	+12V	Yellow

3.6.6 P7, P8 and P9 – SATA/Peripheral Power Connector

Connector housing: Molex* #675820000

Contact: Molex* #67510000

Table 13. P7, P8, and P9 SATA/Peripheral Power

Pin	Signal	18 AWG Colors
1	+12V	Yellow
2	COM	Black
3	+5V	Red
4	COM	Black
5	+3.3V	Orange

3.7 AC Input Requirements

The power supply module incorporates universal power input with active power factor correction, which reduces line harmonics in accordance with the EN61000-3-2 standards.

3.7.1 Efficiency

The following table provides the required minimum efficiency 87%. Efficiency is tested only at 100 and 230 VAC.

Table 14. Efficiency

Loading	100% of Maximum	50% of Maximum	20% of Maximum
Recommended Efficiency	85%	89%	85%

3.7.2 AC Input Voltage Specification

The power supply must operate within all specified limits over the input voltage range shown in the following table.

Table 15. AC Input Rating

Parameter	Minimum	Rated	Maximum
Line Voltage (110)	90 V _{rms}	100 - 127 V _{rms}	140 V _{rms}
Line Voltage (220)	180 V _{rms}	200 - 240 V _{rms}	264 V _{rms}
Frequency	47 Hz	50/60 Hz	63 Hz

Notes:

1. The maximum input line current shall be less than 9.0 Amps RMS at 100VAC when measured under the standard test condition

3.7.3 AC Line Dropout/Holdup

An AC line dropout is defined to be when the AC input drops to 0 VAC at any phase of the AC line for any length of time. During an AC dropout of one cycle or less, the power supply must meet dynamic voltage regulation requirements over the rated load. If the AC dropout lasts longer than one cycle, the power supply should recover and meet all turn-on requirements. The power supply must meet the AC dropout requirement over rated AC voltages, frequencies, and output loading conditions. Any dropout of the AC line does not cause damage to the power supply.

- Minimum Output Holdup: 12 ms
- Minimum Standby Output Holdup: 20 ms

3.7.4 AC Inrush

The maximum inrush current, excluding X-Caps, shall be less than 25 Amps-peak under all conditions.

The inrush current shall decay to its normal operating current in less than 200msec. The inrush current shall be less than 60% of the I²t rating of all the components in series with the charging circuits for the input electrolytic capacitors.

For any conditions during turn-on, the inrush current will not open the primary input fuse or damage any other components.

3.8 Protection Circuits

Protection circuits inside the PDB and the power supply cause the power supply's main +12 V output to shut down, or cause a shutdown of any of the three outputs on the PDB. Any one of these shutdowns results in shutting down the entire power supply / PDB combination. If the power supply latches off due to a protection circuit tripping, an AC cycle OFF for 15 seconds resets the power supply and the PDB.

3.8.1 Over-current Protection (OCP)

Each DC/DC converter output on the PDB has individual OCP protection circuits. The power supply and power distribution board (PS and PDB) shut down and latch off after an over-current condition occurs. This latch is cleared by toggling the PSON# signal or by an AC power interruption. The over-current limits are measured at the PDB harness connectors.

The DC/DC converters are not damaged from repeated power cycling in this condition. The +12 V output from the power supply is divided on the PDB into four channels and each is limited to 240 VA of power. If the limit is exceeded, current sensors and limit circuits shut down the entire PS and PDB. The following table lists the limits.

Table 16. Over-current Protection Limits / 240 VA Protection

Output Voltage	Minimum OCP Trip Limits	Maximum OCP Trip Limits
+3.3 V	110% min (= 26.4 A min)	150% max (= 36 A max)
+5 V	110% min (= 33 A min)	150% max (= 45 A max)
-12 V	125% min (= 0.625 A min)	400% max (= 2.0 A max)
+12 V1	26.0 A min	32 A max
+12 V2	26.0 A min	32 A max
+12 V3	112.5% min (= 18.0 A min)	20 A max
+12 V4	112.5% min (= 18.0 A min)	20 A max

3.8.2 Over-voltage Protection (OVP)

Each DC/DC converter output on the PDB has individual built-in OVP circuits and they are locally sensed. The PS and PDB shut down and latch off after an over-voltage condition occurs. This latch is cleared by toggling the PSON# signal or by an AC power interruption. The over-voltage limits are measured at the PDB harness connectors. The voltage never exceeds the maximum levels when measured at the power pins of the output harness connector during any single point of fail. The voltage never trips any lower than the minimum levels when measured at the power pins of the PDB connector.

Table 17. Over-voltage Protection (OVP) Limits

Output Voltage	OVP Minimum (V)	OVP Maximum (V)
+3.3 V	3.9	4.5
+5 V	5.7	6.5
+5 VSB	5.7	6.5
-12 V	-13.3	-14.5
+12 V1/2/3/4	13.0	14.5

3.8.3 Over-temperature Protection (OTP)

The power supply is protected against over-temperature conditions caused by loss of fan cooling or excessive ambient temperature. In an OTP condition, the power supply shuts down. When the power supply temperature drops to within specified limits, the power supply restores power automatically while the 5 VSB remains constantly on. The OTP trip level has a minimum of 4°C of ambient temperature hysteresis, so the power supply does not oscillate on and off due to a temperature recovery condition. The power supply alerts the system of the OTP condition through the power supply FAIL signal and the PWR LED.

3.9 DC Output Specification

3.9.1 Output Power/Currents

The following table defines power and current ratings for this 750-W continuous (860 W pk) power supply in 1+0 or 1+1 redundant configuration. The combined output power of both outputs does not exceed the rated output power. The power supply must meet both static and dynamic voltage regulation requirements for the minimum loading conditions. Also, the power supply can supply the listed peak currents and power for a minimum of 10 seconds. Outputs are not required to be peak loaded simultaneously.

Table 18. Output Power and Current Ratings

	+12 V	+5 VSB
Maximum Load	62.0 A	3.0 A
Minimum Dynamic Load	3.0 A	0.1 A
Minimum Static Load	0.0 A	0.1 A
Peak Load	70.0 A (12 seconds minimum)	5.0A (0.5 seconds minimum @ turn-on)
Maximum Output Power (continuous)	12 V x 62 A = 744 W maximum	5 V x 3 A = 15 W maximum
Peak Output Power	12 V x 70 A = 840 W pk	5 V x 5 A = 25 W pk

3.9.2 Standby Output/Standby Mode

The 5 VSB output is present when an AC input greater than the power supply turn-on AC voltage is applied. Applying an external 5.25 V to 5 VSB does not cause the power supply to shut down or exceed operating limits. When the external voltage is removed, the voltage returns to the power supplies' operating voltage without exceeding the dynamic voltage limits.

3.10 PMBus™

The PMBus™ features are requirements for AC/DC silver box power supply for use in server systems. It is also required to enable Intel® Intelligent Power Node Manager.

This specification is based on the *PMBus™ specifications parts I and II, revision 1.1X3*.

The power supply device address locations are shown:

PDB addressing Address0/1	0/0	0/1	1/0	1/1
Power supply PMBus™ device	B0h	B2h	B4h	B6h

Note: Power supply units in the Intel® Server System SR2612UR use the 0/0 and 0/1 address locations.

3.10.1 Hardware

The device in the power supply is compatible with both the SMBus 2.0 “high power” specification for I²C Vdd based power and drive (for Vdd = 3.3V). This bus operates at 3.3 V but is tolerant of 5 V signaling. It also operates at full 100 kbps SMBus speed without using clock stretching to slow down the bus.

3.10.2 Data Format

The data format for current, voltage, power, temperature, and fan speed are using the PMBus Literal format.

Literal data format: $X = Y \cdot 2^N$

X = the sensor value in volts, amps, watts, degrees C, or RPM

Y = mantissa. The mantissa is the variable components that changes as the sensor value changes. Y is a 16-bit unsigned value for the READ_VOUT command. For all other READ commands, Y is an

11-bit signed 2's compliment value.

N = exponent. The exponents are fixed for each power supply and define the resolution for each sensor.

3.10.3 Monitoring power/current/voltage

The following PMBus commands are supported for the purpose of monitoring currents, voltages, and power.

PMBus command	Description
READ_IIN	RMS input current in amps
READ_VIN	RMS input voltage in volts
READ PIN	AC input power in watts

3.10.4 Thermal Management

The following commands are supported for monitoring temperature, monitor fan speed, and controlling the power supply fan. The fan monitoring is configured to provide a value in RPM. The fan control is in RPM too. All temperature sensors and fans in the power supply are accessible via PMBus.

Command	Description
READ_FAN_SPEED_1	Returns the fan speed in RPM of fan sensor 1.
READ_FAN_SPEED_2	Returns the fan speed in RPM of fan sensor 2.
READ_TEMPERATURE_1, _2, _3	Returns the temperature in degrees C of temp sensors 1, 2, and 3.
FAN_CONFIG_1_2	Returns the configuration of Fan 1 and Fan 2 in the power supply.
FAN_COMMAND_1_2	Allows the system to request fans in the power supply to be set to the defined RPM. The system cannot cause the power supply to run slower than the power supply needs for cooling.

3.10.5 Capability and inventory reporting

The follow commands are supported for discovery of the power supplies capabilities.

Command	Meaning
CAPABILITY	Defines the power supplies PEC support, bus speed, and support of SMBAlert.
QUERY	Defines the power supplies PEC support, bus speed, and support of SMBAlert.
PAGE	The PAGE command is used to QUERY a specific output of a multi-output power supply.

3.10.5.1 Revision and inventory information

- PMBUS_REVISION
- MFR_ID
- MFR_MODEL
- Power supply ratings
- MFR_VIN_MIN
- MFR_VIN_MAX
- MFR_IIN_MAX
- MFR_PIN_MAX
- MFR_TAMBIENT_MAX
- MFR_EFFICIENCY_LOW
- MFR_EFFICIENCY_HIGH

3.11 Power Supply Status LED

Each power supply module has a single bi-color LED to indicate power supply status. The following table defines the LED operation.

Table 19. LED Indicators

Power Supply Condition	Bi-Color LED
No AC power to all power supplies	Off
No AC power to this PSU only (for 1+1 configuration) or Power supply critical event causing a shutdown: failure, fuse blown (1+1 only), OCP, OVP, fan failed	Amber
Power supply warning events where the power supply continues to operate: high temperature, high power, high current, slow fan.	1 Hz Blink Amber
AC present / Only 5 VSB on (PS Off)	1 Hz Blink Green
Output ON and OK	Green

The LED is visible on the rear panel of each installed power supply module.

4. Cooling Subsystem

Several components and configuration requirements make up the cooling subsystem of the system. These include the system fan module, power supply fans, CPU air duct, and drive bay population. All are necessary to provide and regulate the airflow and air pressure needed to maintain the system's thermals when operating at or below the maximum specified thermal limits.

The system uses four non-redundant fans providing sufficient airflow to maintain internal system thermal requirements when the external ambient temperature remains within specified limits.

The system uses a variable fan speed control engine to provide adequate cooling for the system at various ambient temperature conditions, under various server workloads, and with the least amount of acoustic noise possible. To minimize acoustics, the fans operate at the lowest speed for any given condition.

The Integrated Baseboard Management Controller (Integrated BMC) on the Intel® Server Board S5520UR is used for the variable fan speed control function. The Integrated BMC monitors selective component temperatures, the ambient temperature, and each fan's RPM to determine the necessary airflow. The Integrated BMC sets the fan speeds to the appropriate RPM to maintain proper cooling. The Integrated BMC also logs errors into the System Event Log (SEL) when temperature sensors exceed their safe operating ranges, or if any of the fans fail to operate at safe airflow speeds.

If a fan fails, the Integrated BMC boosts the remaining fans to compensate for the lost airflow. If the cooling is not sufficient under a failed fan condition, the system eventually shuts down to protect its primary components from thermal damage.

4.1 Airflow paths

The airflow in the system is divided into three zones:

- Zone 1 is the CPU and Memory cooling zone.
- Zone 2 is the PCI cooling zone.
- Zone 3 is the power supply cooling zone.

The disk drives located in the front of the shelves are cooled by a combination of all three zones.

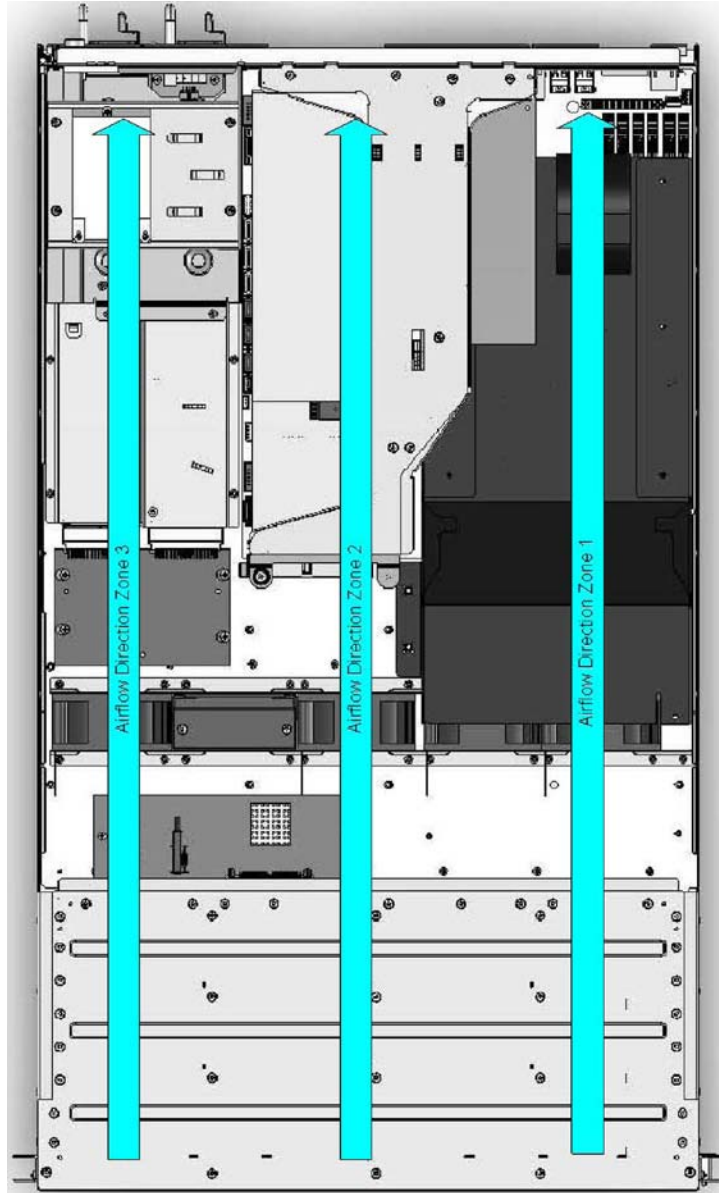
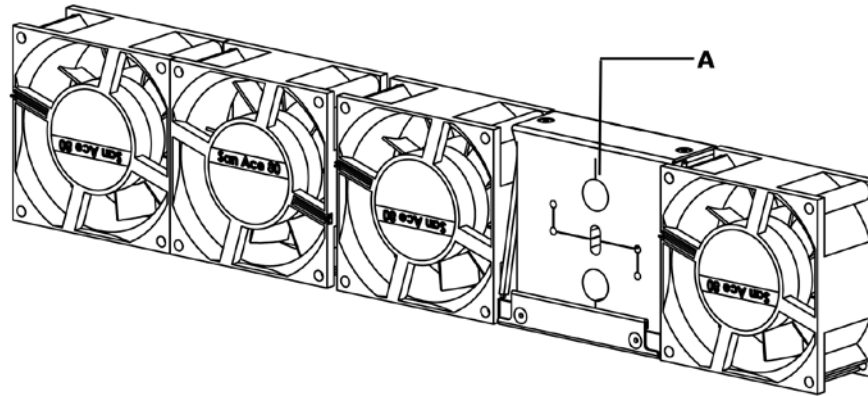

Figure 15. Airflow Paths

4.2 System Fan Module



A: Foam Insertion for Cable Retention

Figure 16. Non-redundant Fan Module

The system fan module, which includes four non-redundant 80-mm fans, is designed for ease of use and supports several management features that the Integrated Baseboard Management Controller can use.

- The system fans plug into headers on the server board.
- Each fan within the module is capable of supporting multiple speeds. If the external ambient temperature of the system exceeds the value programmed into the thermal sensor data record (SDR), the Integrated BMC firmware increases the speed for all the fans within the fan module.
- Each fan is responsible for cooling a specific zone of the system. If the components in the zone begin to exceed a safe operating temperature as programmed by the SDR, the Integrated BMC firmware increases the speed for the fans tied to that zone.
- Each fan connector within the module supplies a tachometer signal that allows the Integrated BMC to monitor the status of each fan. If one of the fans fails, the remaining fans increase their rotation and attempt to maintain the thermal requirements of the system.
- Fan for CPU and Memory zone has associated fault LED on the server board next to the fan header. If a fan fails, system management will illuminate the system fault LED. Each fan has an associated fault LED on the midplane located next to the fan header. If a fan fails, system management illuminates the associated server board fan fault LED for the failing fan.
- The foam cable retention assembly allows cables to cross from the server board side of the system to the midplane side of the system without unduly affecting the cooling solution.

Note: The fans are NOT hot-swappable. You must turn-off the system to replace a failed fan.

Table 20. Non-redundant Fan Connector Pin Assingment

Pin	Signal Name	Description
1	Return	Return path to ground
2	12V	Power for fan
3	FOO	Fan Tachometer signal
4	PWM	Fan speed control signal

4.3 Airflow Support

Table 21. Non-redundant Cooling Zones

Fan	Cooling Zone	Description of greatest cooling influence
System Fan #1 and #2	Processor and Memory	Primary cooling for CPU, memory, and hard drives
System Fan #3	PCI	Primary cooling for PCI cards, Intel® S5520 chipset IOH, and hard drives
System Fan #4	Power Supply	Primary cooling for hard drives and the power supply modules.

To control airflow within the system, the system uses a CPU air duct to isolate and direct airflow to three critical zones: power supply zone, PCI zone, and CPU/memory zone.

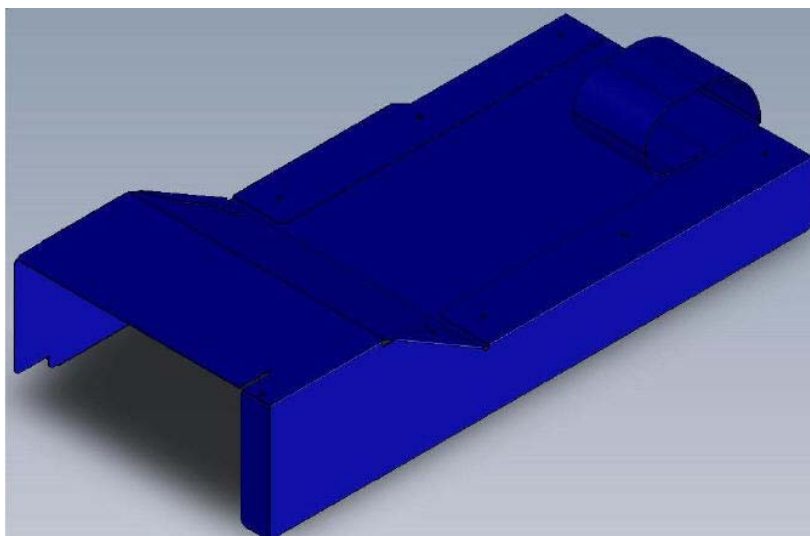
**Figure 17. CPU / Memory Air Duct**

4.4 Drive Bay Population

To maintain proper air pressure within the system, all hard drive bays must be populated with either a hard drive or drive blank.

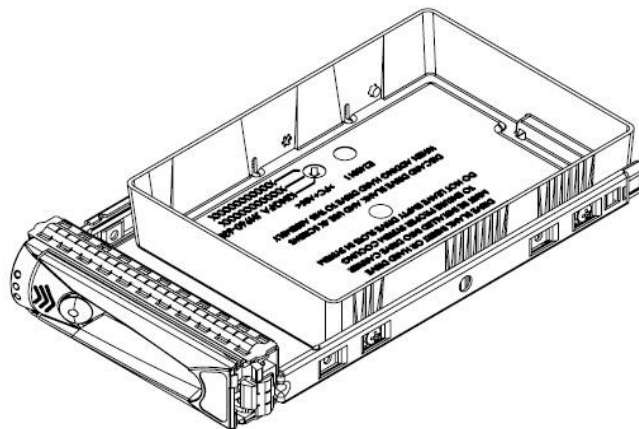

Figure 18. 3.5-inch Drive Carrier with a Blank

4.5 SATA HDD Support

The maximum supported temperatures when using SATA drives are affected as follows:

- At 1500 m (5000 ft), the maximum ambient temperature is 25°C.
- At 300 m (1000 ft), the maximum ambient temperature is 35°C.

5. System Board Interconnects

System boards within the system include the midplane, bridge board, hot-swap backplane, and control panel. This chapter describes the interconnect features of each and defines the pin-outs for each connector. Later chapters describe functional details of each system board.

5.1 Active SAS Midplane

The midplane is designed around a PMC8388 24-port SAS expander.

The midplane provides SAS connectivity between any attached SAS host adapter and the 12 3.5-inch SAS/SATA hard disk drives located in the front of the enclosure.

The SAS connector to SAS host adapter is through an industry standard MiniSAS connector as defined in SFF-8087.

In addition to providing SAS connectivity, the I/O module also supports in-band SES communications allowing the attached HBA and its associated management application to manage the attached storage

The following figure shows the location for each connector found on the active SAS midplane board.

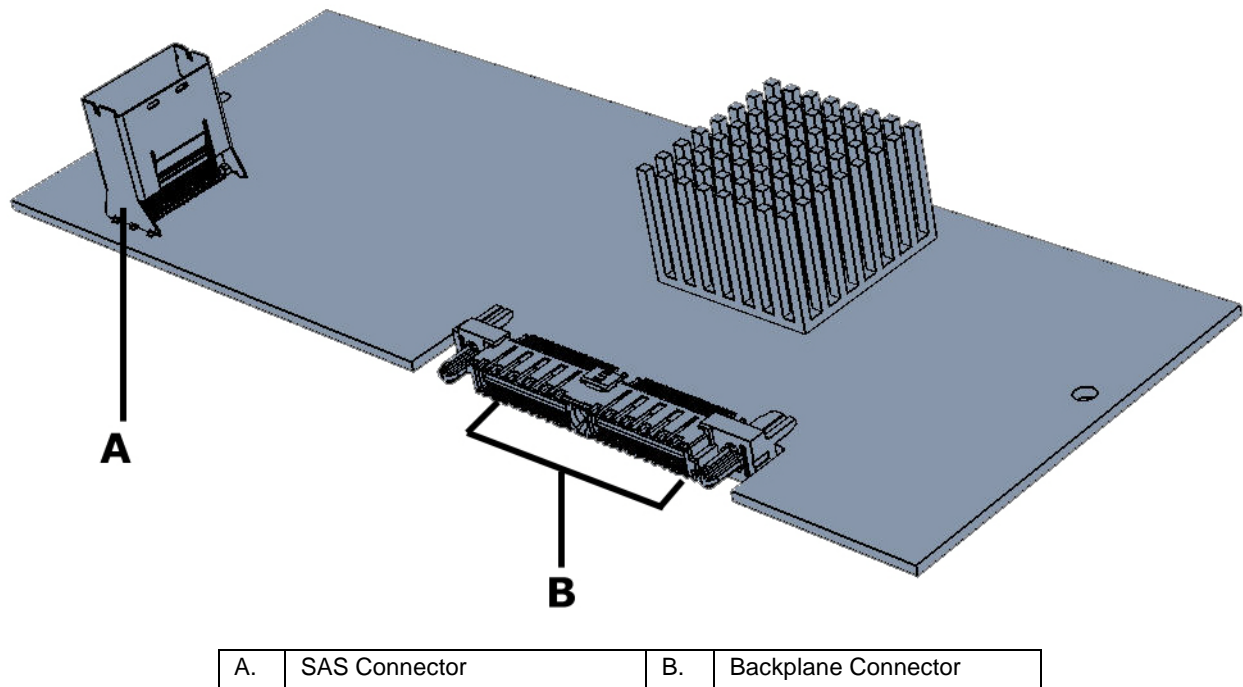

Figure 19. Active SAS Midplane Board

The following tables define the connector pin-outs for Midplane board.

Table 22. SAS Connector Pin-out (J2)

Pin	Signal name	Pin	Signal name
1	GND	A1	GND
2	HOST1_TO_IO_1+	A2	RX0+
3	HOST1_TO_IO_1-	A3	RX0-
4	GND	A4	GND
5	HOST1_TO_IO_2+	A5	RX1+
6	HOST1_TO_IO_2-	A6	RX1-
7	GND	A7	GND
8	Sideband connection	B8	SB0
9	Sideband connection	B9	SB1
10	Sideband connection	B10	SB2
11	Sideband connection	B11	SB6
12	GND	A12	GND
13	HOST1_TO_IO_3+	A13	RX2+
14	HOST1_TO_IO_3-	A14	RX2-
15	GND	A15	GND
16	HOST1_TO_IO_4+	A16	RX3+
17	HOST1_TO_IO_4-	A17	RX3-
18	GND	A18	GND
19	GND	B1	GND
20	IO_TO_HOST1_1-	B3	TX0-
21	IO_TO_HOST1_1-	B2	TX0+
22	GND	B4	GND
23	IO_TO_HOST1_2-	B6	TX1-
24	IO_TO_HOST1_2+	B5	TX1+
25	GND	B7	GND
26	Sideband connection	A8	SB7
27	Sideband connection	A9	SB3
28	Sideband connection	A10	SB4
29	Sideband connection	A11	SB5
30	GND	B12	GND
31	IO_TO_HOST1_3-	B14	TX2-
32	IO_TO_HOST1_3+	B13	TX2+
33	GND	B15	GND
34	IO_TO_HOST1_4-	B17	TX3-
35	IO_TO_HOST1_4+	B16	TX3+
36	GND	B18	GND

5.2 Hot-swap SAS/SATA Backplane

The hot-swap backplane provides support for both SAS and SATA hard drives. There are no hard drive cables that connect to the backplane. All hard drive control signals are routed from the midplane board, which plugs directly into the backplane.

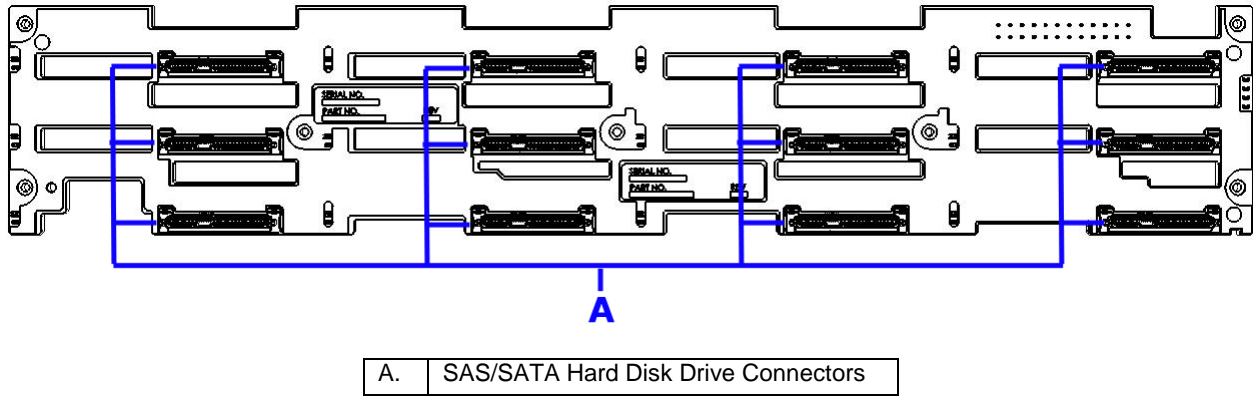

Figure 20. 3.5-inch Hot-swap SAS/SATA Backplane (Front Side View)

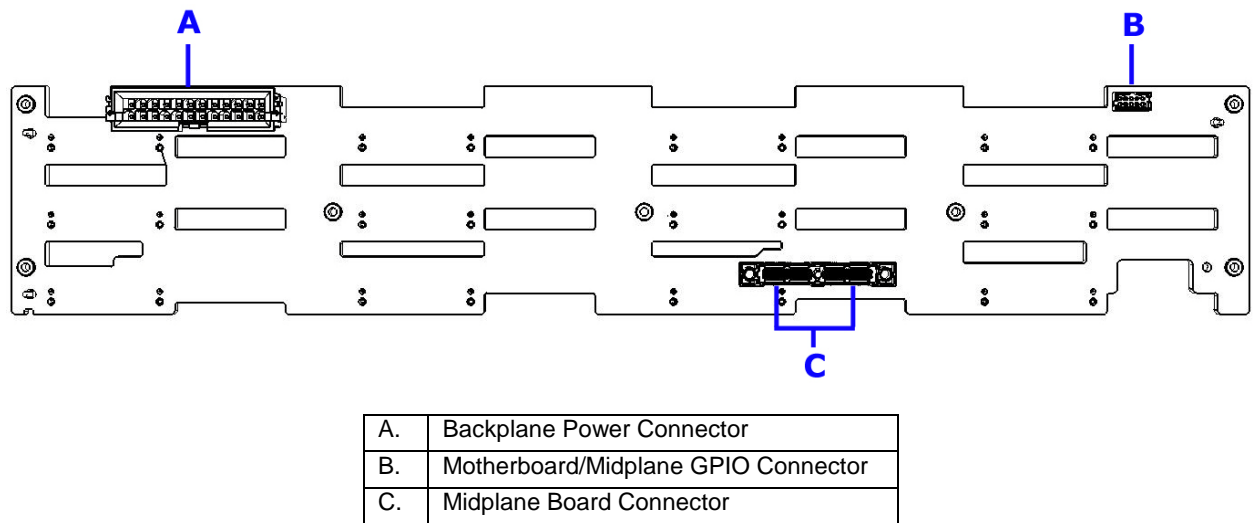

Figure 21. 3.5-inch Hot-swap SAS/SATA Backplane (Back Side View)

The following tables define the connector pin-outs for backplane board.

Table 23. Motherboard to Backplane GPIO Pin-out (J20)

Pin	Signal	Pin	Signal
1	NC	2	NC
3	LAN2_LINK_L	4	LAN1_LINK_L
5	LAN2_LED_L	6	LAN1_LED_L
7	GND	8	GND
9	IPMB_SCLK	10	IPMB_SDAT

Table 24. Backplane Power Supply Pin-out (J23)

Pin	Signal	Pin	Signal
1	+3.3V	13	+3.3V
2	+3.3V	14	+12V
3	GND	15	GND
4	+5V	16	GND
5	GND	17	GND
6	+5V	18	GND
7	GND	19	GND
8	+12V	20	+12V
9	Fan Power (+12V)	21	+5V
10	Fan Power (+12V)	22	+5V
11	+12V	23	+5V
12	+3.3V	24	GND

Table 25. SAS/SATA Hard Drive Connector Pin-outs (J1, J2, ..., J12)

Pin	Signal	Pin	Signal
1	GND	17	+3.3V
2	IO1_TO_DR#+ (# = 1...12)	18	GND
3	IO1_TO_DR#- (# = 1...12)	19	NC
4	GND	20	GND
5	DR#_TO_IO1- (# = 1...12)	21	+5V
6	DR#_TO_IO1+ (# = 1...12)	22	+5V
7	GND	23	+5V
8	GND	24	GND
9	IO2_TO_DR#+ (# = 1...12)	25	DR#_ACTIVITY_LED_L (# = 1...12)
10	IO2_TO_DR#- (# = 1...12)	26	GND
11	GND	27	+12V
12	DR#_TO_IO2- (# = 1...12)	28	+12V
13	DR#_TO_IO2+ (# = 1...12)	29	+12V
14	GND	30	GND
15	+3.3V	31	GND
16	+3.3V		

5.2.1 Hard Drive Activity and Fault LEDs

Each populated disk drive carrier has three LEDs that indicate the status of the disk drive, as described in the following table.



Table 26. Hard Drive LED Function Definitions

LED	Function	Color	Flash Pattern	Indication
1.	Not Used	N/A	N/A	N/A
2.	Disk Status	Green / Amber	Repeating cycle of Green for 250 milliseconds/Off for 250 milliseconds	Identify
			Amber On constantly	Fault
			Repeating cycle of Amber for 250 milliseconds/Off for 250 milliseconds	Predicted Fail
			Repeating cycle of Amber for 500 milliseconds/Green for 500 milliseconds	Reserved Device
			Repeating cycle of Amber for 500 milliseconds/Green for 500 milliseconds (Green On constantly with Midplane firmware 105 or later)	Hot Spare
			Repeating cycle of Amber for 500 milliseconds/Green for 500 milliseconds	Consistency Check
			Repeating cycle of Amber for 500 milliseconds/Green for 500 milliseconds	In Critical Array
			Repeating cycle of Amber for 500 milliseconds/Green for 500 milliseconds	In Failed Array
			Repeating cycle of Green for 750 milliseconds/Off for 250 milliseconds	Rebuild
			Repeating cycle of Green for 500 milliseconds/Off for 500 milliseconds	Prepare for Operation
Repeating cycle of Green for 500 milliseconds/Off for 500 milliseconds	Prepare for Removal			
3.	Disk Activity	Green	Green Off	SATA Hard Drive No Activity
			Green On	SAS Hard Drive No Activity
			Green Flash	Drive Activity

The hard drives directly control the activity LED functionality. This causes the LED to function differently between SAS and SATA drives.

Note: The drive status LED may also be set by the add-in SAS RAID controller or by RAID management software to represent different RAID array states. Refer to the RAID controller or software documentation.

5.3 Remote RAID Controller Battery Backup Unit Mount

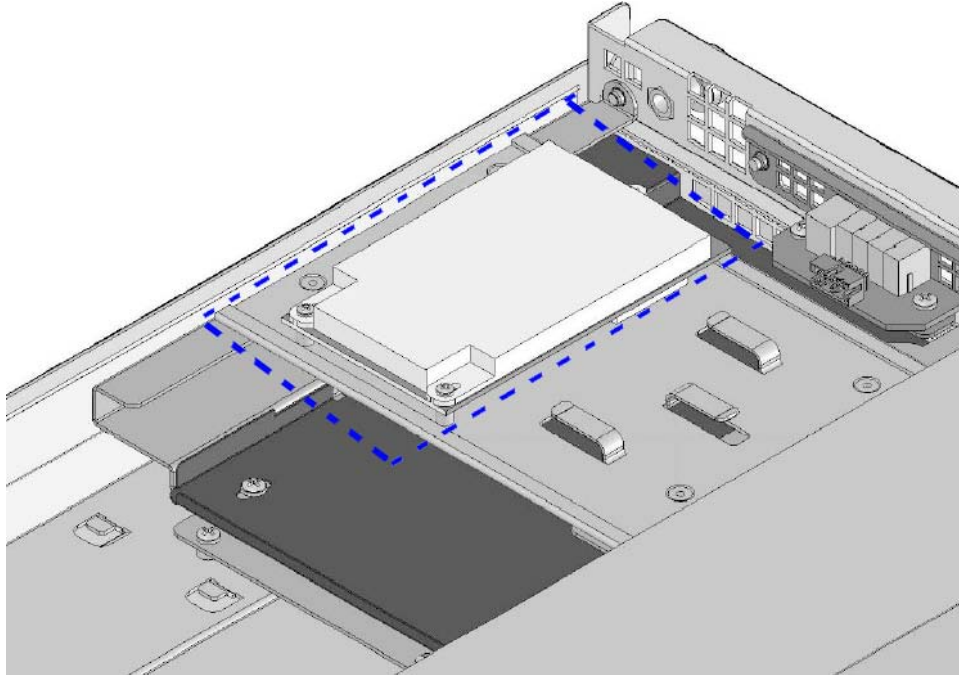
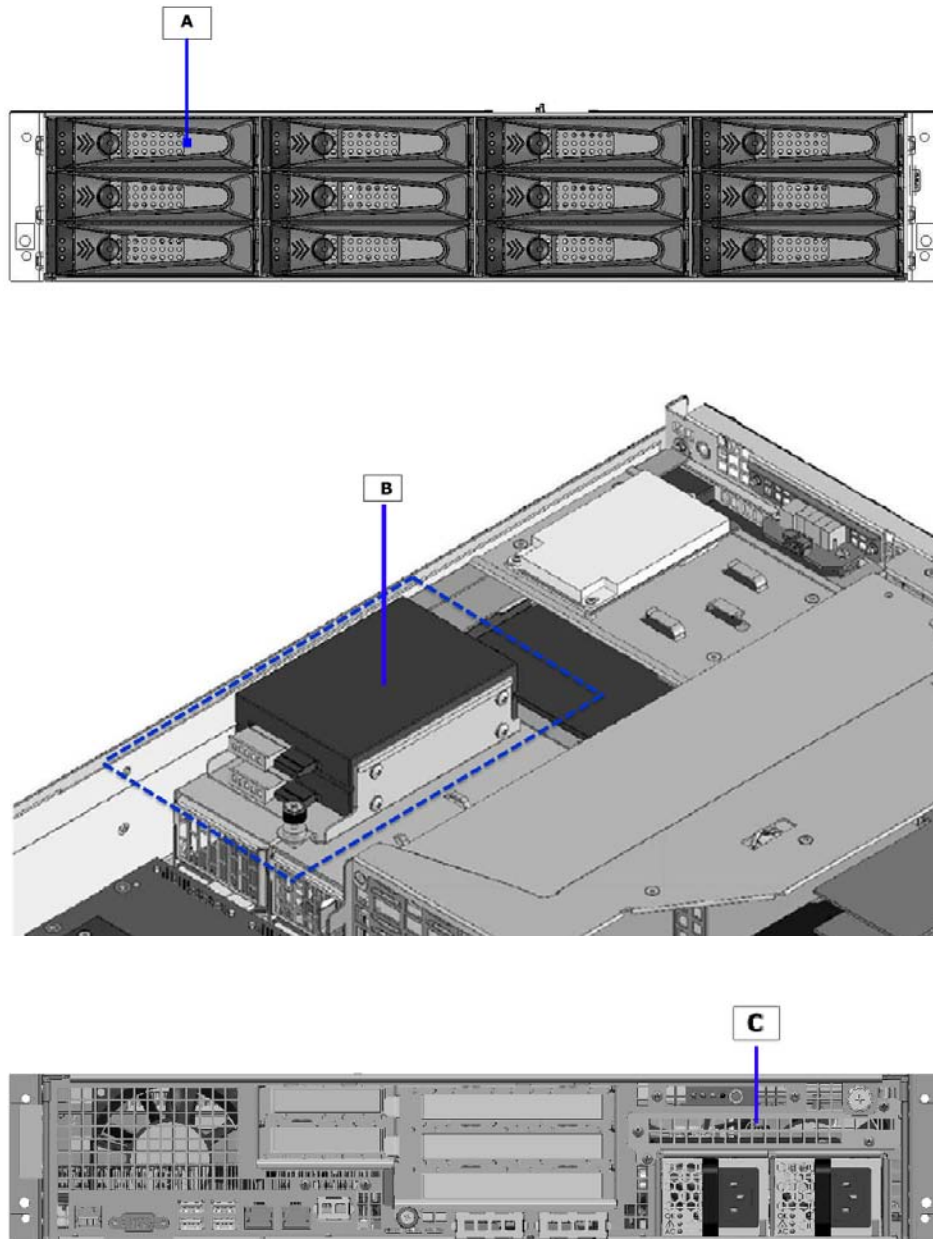

Figure 22. Remote RAID BBU Mount

The space is provided to mount a remote Battery Backup Unit (BBU) for a hardware RAID controller card. This mount point ensures the BBU is attached correctly to chassis ground and is located in an area of enclosure that ensures correct BBU cooling.

6. Peripheral and Hard Drive Subsystem

You can configure the system to support several different hard drive and peripheral configurations. The peripheral/hard drive subsystem consists of a drive bay supporting a slimline optical drive, hard drives, and a flex bay; a midplane; and a hot-swap backplane. This chapter describes the details for each subsystem component.



A.	Hot-Swap 3.5-inch Hard Drive Bays (12)
B.	Internal fixed 2.5-inch SATA Hard Drive Bays (2)
C.	Slimline SATA Optical Drive Bay (1)

Figure 23. Drive Bay Overview

6.1 Slimline Optical Drive Bay

The system provides a slimline drive bay designed to support a single slimline SATA optical drive. For a list of supported drives, refer to the *Server Configurator Tool* available at: <http://serverconfigurator.intel.com/default.aspx>

The optical drive is mounted to a tool-less assembly latch that allows for easy installation and attachment to the system. Once it is inserted into the system, the assembly locks into place. It is not hot-swappable. For removal, you must power down the system, remove the system's top cover, and disengage the locking latch. For additional details, see the *Intel® Server System SR2612UR Service Guide*.

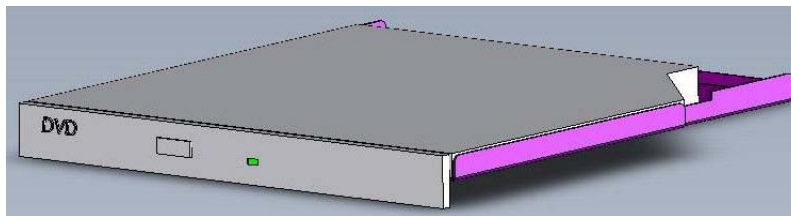

Figure 24. Slimline Optical Drive Assembly

The SATA Optical drive plugs directly into the backplane using industry standard 13-pin SATA connector. This SATA channel is routed from the USB to the SATA converter located on the backplane. The optical drive is seen as a USB device in the system.

6.2 Hard Drive Bays

The system supports up to 12 hot-swap 3.5-inch SAS or SATA hard disk drives. Hard drives are mounted to hot-swap drive trays for easy insertion to or extraction from the drive bay. Two additional fixed mount 2.5-inch drives are supported with an internal drive cage.

6.2.1 Hot-swap Drive Carriers

Each hard drive must be mounted to a hot-swap drive carrier, making insertion and extraction of the drive from the system very simple. Each drive carrier has its own dual-purpose latching mechanism, which is used to both insert/extract drives from the system and lock the carrier in place. Each drive tray supports a light pipe that provides a drive status indicator. The light pipe is located on the backplane, which you can view from the front of the system.

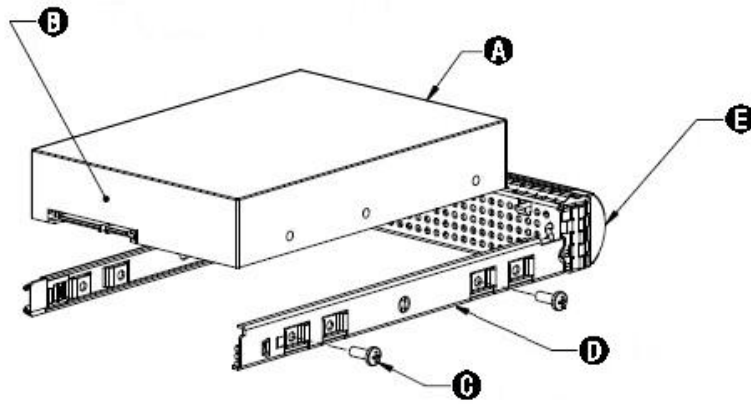

A.	Hard Drive
B.	Hard Drive Connector
C.	Mounting Screw
D.	Side Rail
E.	Drive Carrier

Figure 25. 3.5-inch Hard Drive Tray Assembly

7. Control Panel

The Intel® Server System SR2612UR provides one front LED panel and one rear control panel. Both front LED panel and rear control panel provide LEDs for monitoring system status, and the rear control panel supports power button.

Control panels from previous server generations or other server platforms are not compatible with the Intel® Server System SR2612UR.

7.1 Front LED Panel

The front LED panel houses several status LEDs. The following table lists the function of the status LED.

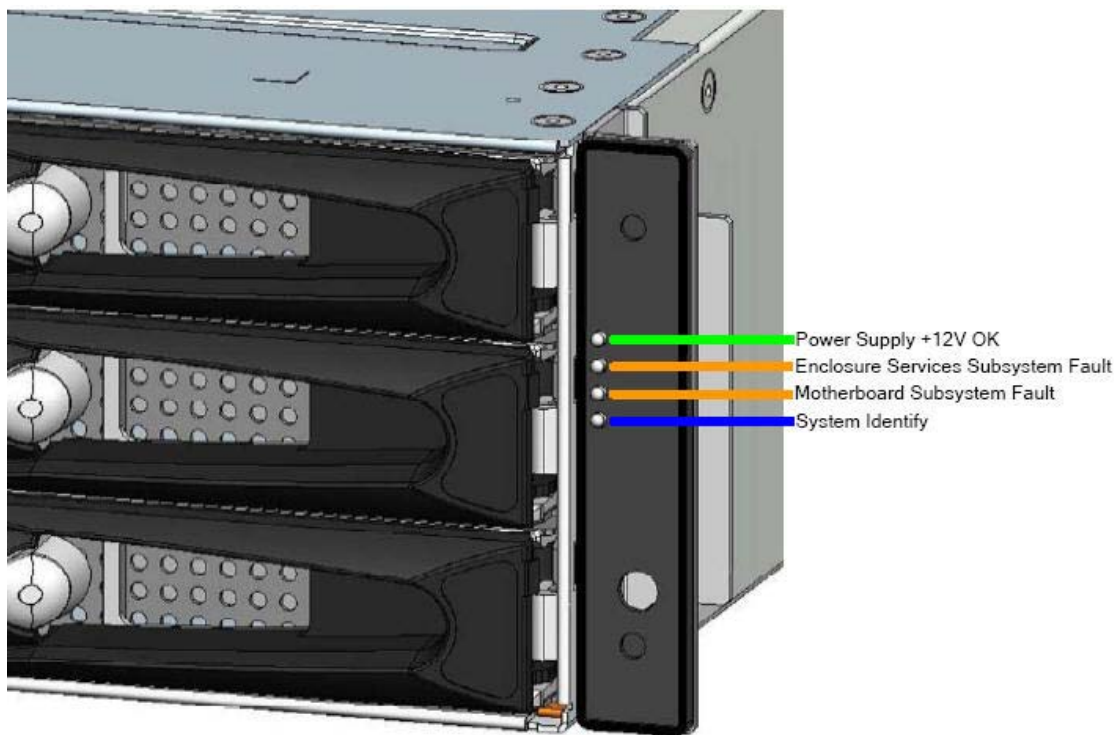

Figure 26. Front LED Panel

Table 27. Front LED Panel Definition

LED	Color	Function
Power Supply +12V OK	Green	The initial state of this LED is off. This green LED will be illuminated when the power supplies main +12V output is enabled.
Enclosure Services Subsystem Fault	Amber	The initial state of this LED is off. This amber LED will be illuminated if the Enclosure Service Processor (SEP) located on midplane detects a failure condition.
System Status LED	Amber	The initial state of this LED is off. The amber LED will be solid on or blink to reflect the system status.

LED	Color	Function
System Identify LED	Blue	The initial state of this LED is off. This blue ID LED can be illuminated by server system management software.

7.2 Rear Control Panel

The rear control panel houses the power switch and four status LEDs to display the system's operating state. The following table defines the rear control panel's LED functionalities.

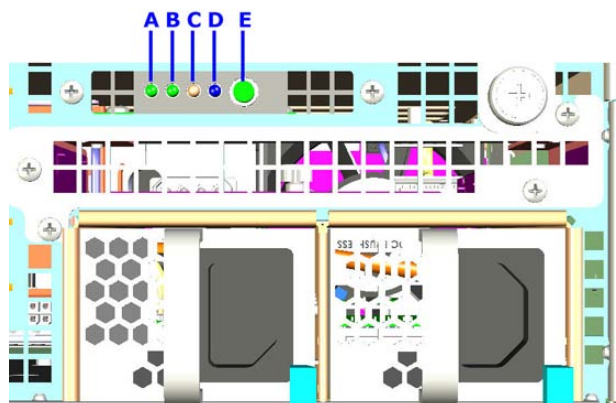

Figure 27. Rear Control Panel

Table 28. Rear Control Panel Functions

Item	Function	Color	State	Description
A.	Standby Power OK LED (+3.3V)	Green	Off	AC power off
			On	AC power on or DC power on
B.	System Status LED	Green	Solid On	System booted and ready
			Blink	Degraded
C.	System Status LED	Amber	Blink	Non-critical
			Solid On	Critical, non-recoverable
D.	System Identification LED	Blue	On	Identify active through command
			Off	No Identification
E.	Power Switch	N/A	N/A	N/A

7.3 System Status LED

Table 29. Control Panel LED Operation

Color	State	Criticality	Description
Off	N/A	Not ready	AC power off
Green	Solid on	OK	System booted and ready
Green	Blink	Degraded	System degraded Including, but not limited to: <ul style="list-style-type: none"> ▪ Unable to use all of the installed memory (more than one DIMM installed).

Color	State	Criticality	Description
			<ul style="list-style-type: none"> ▪ Correctable errors over a threshold of ten and migrating to a spare DIMM (memory sparing). This indicates that the user no longer has spare DIMMs specifying a redundancy lost condition. The corresponding DIMM LED should light up. ▪ In a mirrored configuration, when memory mirroring takes place and system loses memory redundancy. This is not covered by the previous bullet. ▪ Redundancy loss such as power supply or fan. This does not apply to non-redundant subsystems. ▪ PCI Express* link errors ▪ CPU failure / disabled – if there are two processors and one of them fails. ▪ Fan alarm – Fan failure. Number of operational fans should be more than the minimum number needed to cool the system. ▪ Non-critical threshold crossed – temperature and voltage.

Color	State	Criticality	Description
Amber	Blink	Non-critical	<p>Non-fatal alarm – system is likely to fail</p> <p>Including, but not limited to:</p> <ul style="list-style-type: none"> ▪ Critical voltage threshold crossed ▪ VRD hot asserted ▪ Minimum number of fans to cool the system are not present or have failed. ▪ In non-sparing and non-mirroring mode if the threshold of ten correctable errors is crossed within the window.
Amber	Solid on	Critical, non-recoverable	<p>Fatal alarm – system has failed or shut down</p> <p>Including, but not limited to:</p> <ul style="list-style-type: none"> ▪ DIMM failure when there is one DIMM present and no good memory is present. ▪ Run-time memory uncorrectable error in non-redundant mode. ▪ IERR signal asserted ▪ Processor 1 missing ▪ Temperature (for example, CPU ThermTrip, memory TempHi, critical threshold crossed) ▪ No power good – power fault. ▪ Processor configuration error (for example, processor stepping mismatch)

7.4 System Identification LED

The blue system identification LED helps to identify a system for servicing. This is especially useful when the system is installed in a high-density rack or cabinet populated with several similar systems.

The blue system ID LED lights-up by issuing the appropriate hex IPMI system identify value, the ID LED either blinks blue for 15 seconds and turns off or blinks indefinitely until the appropriate hex IPMI system identify value is issued to turn it off.

8. PCI Riser Cards and Assembly

The system supports different riser card options depending on the add-in card configuration desired. The riser assembly for the system is tool-less. Standoffs on the bracket allow the riser cards to slide onto the assembly where a latching mechanism secures each riser in place. Holding down the latch releases the risers for easy removal.

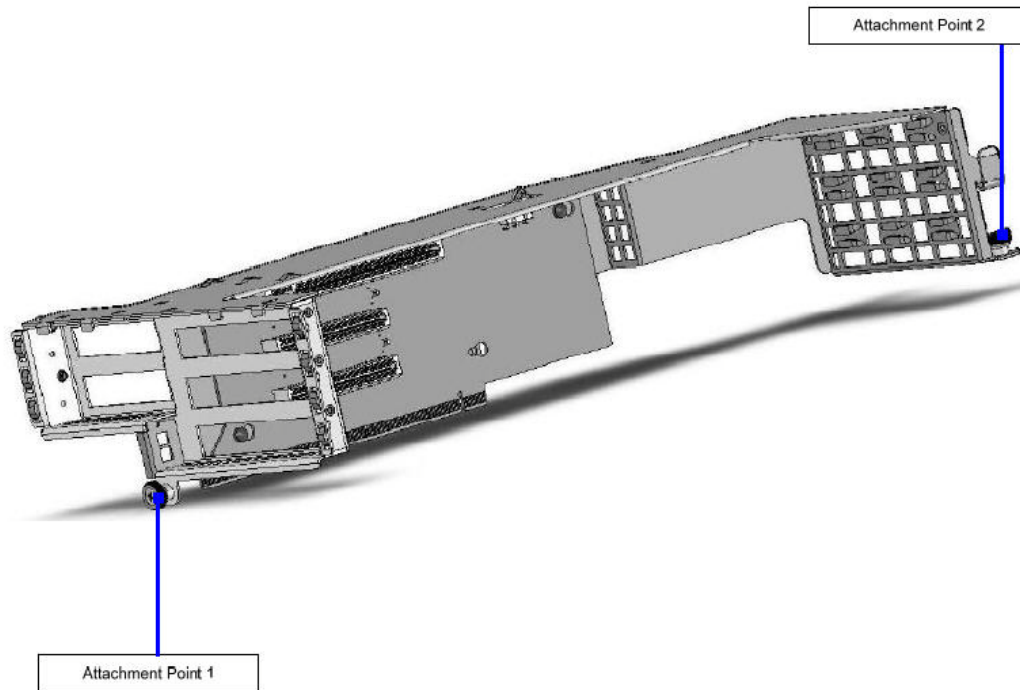

Figure 28. 2U Riser Assembly

The Riser Card assembly has two hard attachment points that attach the assembly to the main chassis. These pieces of captive hardware do not require any special tools to remove.

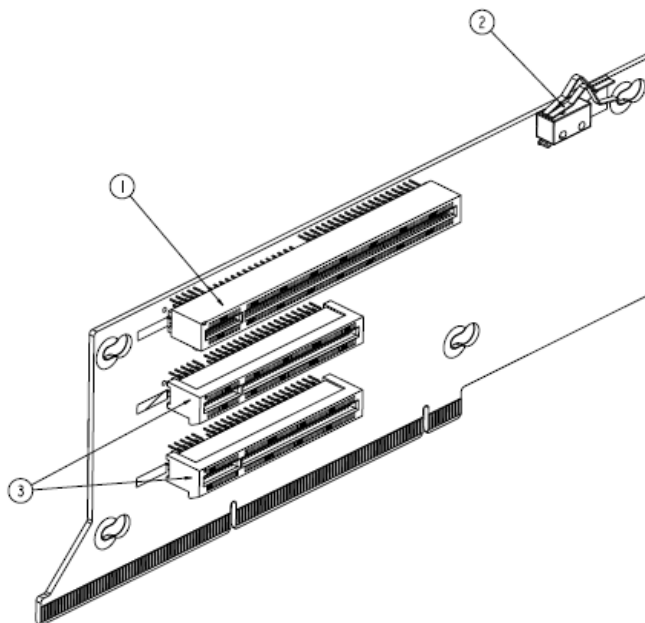

Figure 29. 2U PCI Express* Passive Riser

8.1 Riser Card Options

The Intel® Server Board S5520UR has one riser slot capable of supporting riser cards for both 1U and 2U system configurations. The riser slot (J4E1) implements Intel® Adaptive Slot Technology. This 280-pin connector is capable of supporting riser cards that meet either the PCI-X or PCI Express* technology specifications. Some risers can support both full-height and low-profile add-in cards by using a ‘butterfly’ configuration. The riser card assembly uses screws to attach the PCI bracket to the riser card assembly.

The following table identifies the card configurations and the connector types used.

Table 30. Riser Card Options

Riser Card Option	Slot Configuration
2U PCI Express* Passive Riser (Product Order Code – ASR26XXFHR)	Three full-height PCI Express* connectors. Ship in Intel® Server System SR2612UR
2U Butterfly PCI Express* Active Riser (Product Order Code – ASR26XXFHLPR)	Three full-height PCI Express* connectors Two low-profile PCI Express* connectors

Note: All PCI Express* add-in cards run at x8 speeds independent of population. The PCI Express* x16 connectors use a x8 electrical connection.

8.2 PCI Riser Card Mechanical Drawings

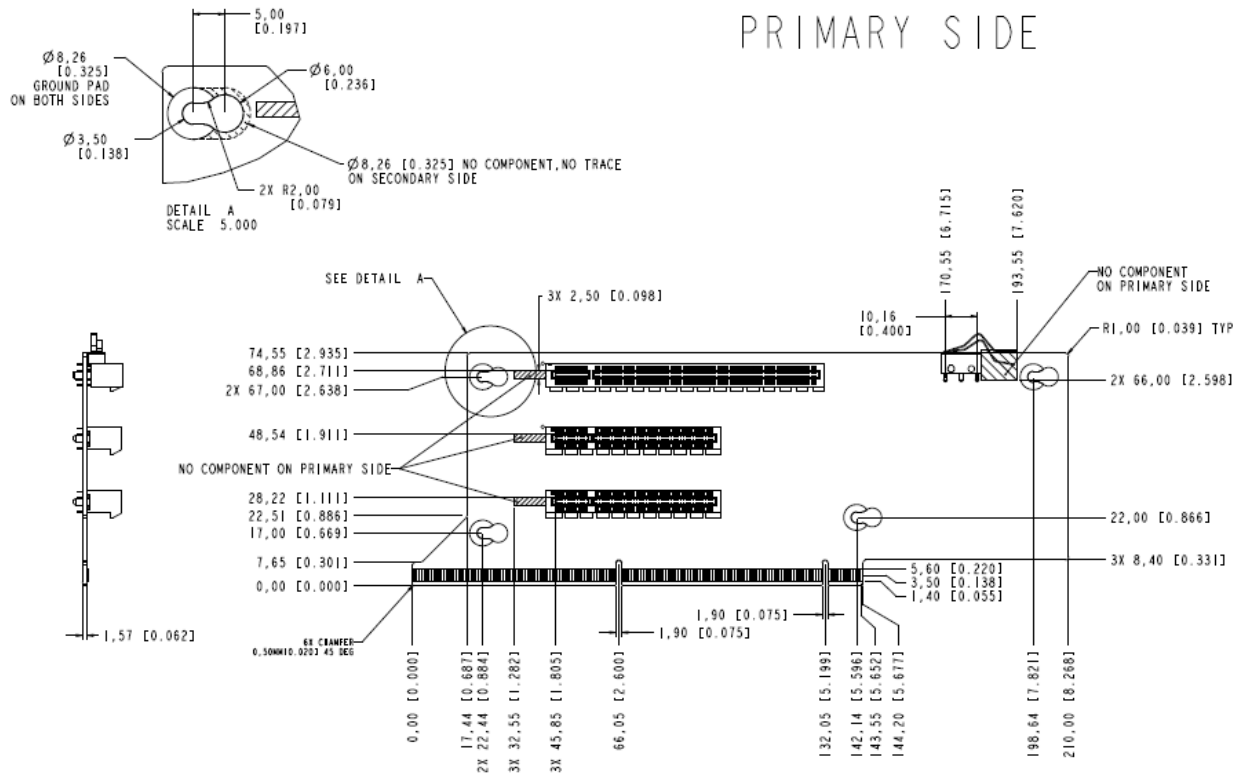

Figure 30. 2U PCI Express* Passive Riser – Primary Side

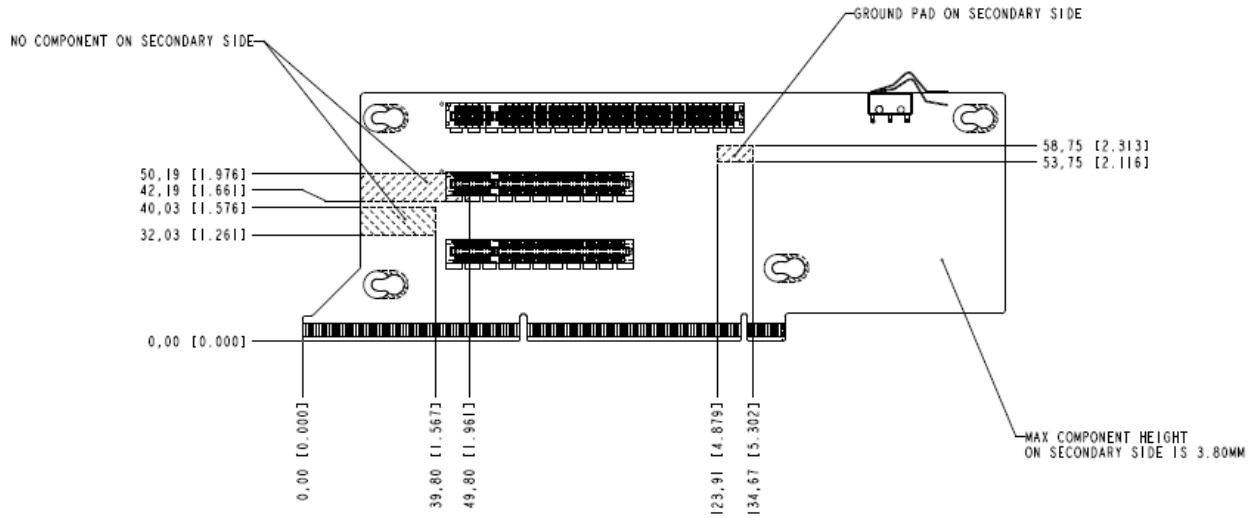

Figure 31. 2U PCI Express* Passive Riser – Secondary Side

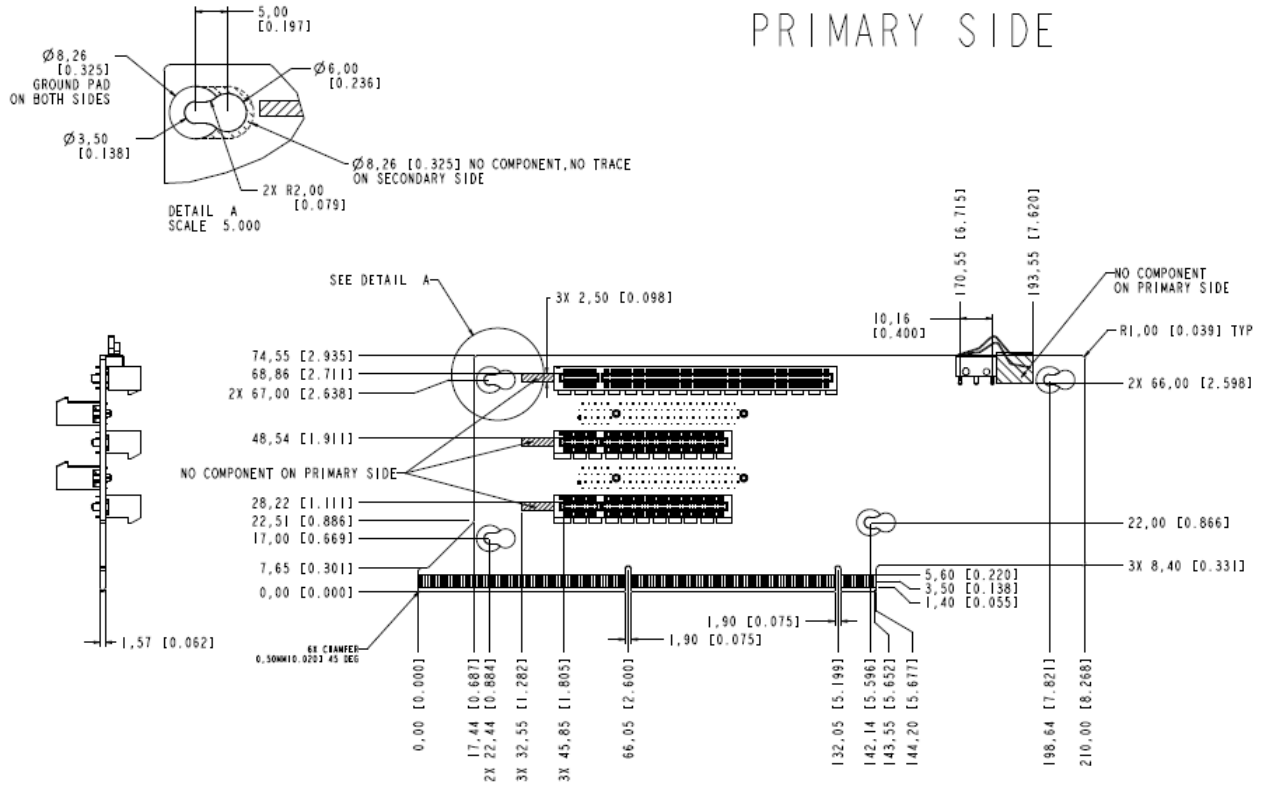

Figure 32. 2U Butterfly PCI Express* Active Riser – Primary Side

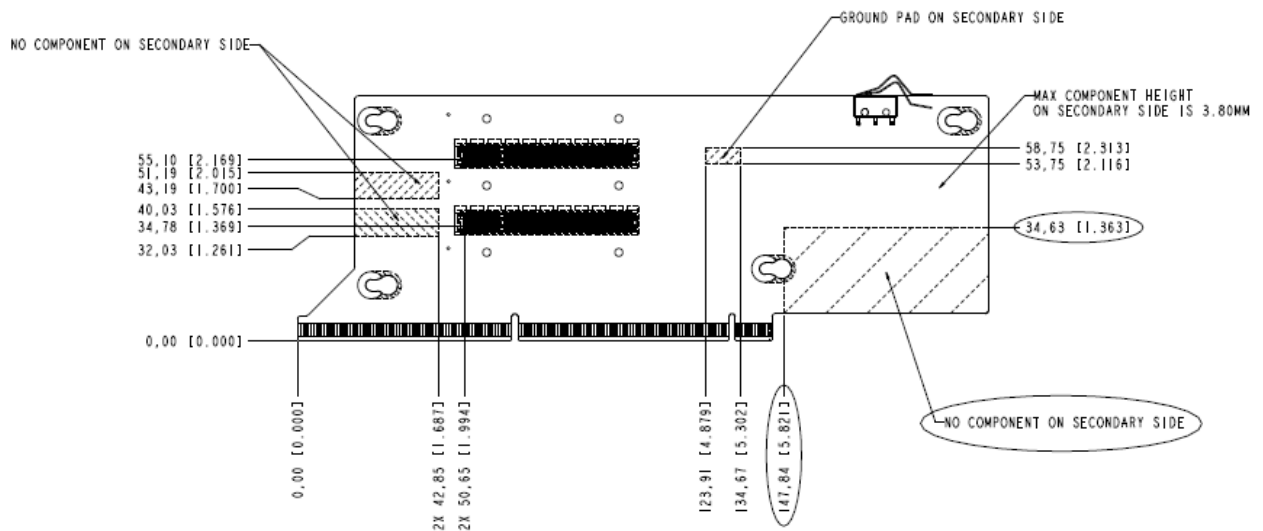

Figure 33. 2U Butterfly PCI Express* Active Riser – Secondary Side

9. Environmental Specifications

9.1 System Level Environmental Limits

The following table defines the system level operating and non-operating environmental limits.

Table 31. System Environmental Limits Summary

Parameter	Limits
Operating Temperature	+10° C to +35° C with the maximum rate of change not to exceed 10°C per hour
Non-Operating Temperature	-40° C to +70° C
Non-Operating Humidity	90%, non-condensing at 35° C
Acoustic noise	Sound power: 7.0 BA in an idle state at typical office ambient temperature. (23 +/- 2° C)
Shock, operating	Half sine, 2 g peak, 11 milliseconds
Shock, unpackaged	Trapezoidal, 25 g, velocity change 136 inches/second (≥ 40 lbs to < 80 lbs)
Shock, packaged	Non-palletized free fall in height 24 inches (≥ 40 lbs to < 80 lbs)
Vibration, unpackaged	5 Hz to 500 Hz, 2.20 g RMS random
ESD	+/-15 KV except I/O port +/- 8 KV per Intel® Environmental test specification
System Cooling Requirement in BTU/Hr	2550 BTU/hour

9.2 Serviceability and Availability

The system is designed to be serviced by qualified technical personnel only.

The desired Mean Time To Repair (MTTR) of the system is 30 minutes, which includes diagnosing the system problem. To meet this goal, the system enclosure and hardware were designed to minimize the MTTR.

The following table defines the maximum time needed by a trained field service technician to perform the listed system maintenance procedures after diagnosing the system and identifying the failed component.

Table 32. Time Estimate for System Maintenance Procedures

Activity	Time Estimate (Minutes)
Remove cover	1
Remove and replace hard disk drive	2
Remove and replace power supply module	1
Remove and replace system fan	3
Remove and replace backplane board	9
Remove and replace control panel module	2
Remove and replace server board	11

9.3 Replacing the Backup Battery

The lithium battery on the server board powers the real time clock (RTC) for up to 10 years in the absence of power. When the battery starts to weaken, it loses voltage, and the server settings stored in CMOS RAM in the RTC (e.g., the date and time) may be wrong. Contact your customer service representative or dealer for a list of approved devices.

**WARNING**

Danger of explosion if battery is incorrectly replaced. Replace only with the same or equivalent type recommended by the equipment manufacturer. Discard used batteries according to manufacturer's instructions.

**ADVARSEL!**

Lithiumbatteri - Eksplosjonsfare ved feilagtig håndtering. Utskiftning må kun ske med batteri af samme fabrikat og type. Levér det brugte batteri tilbage til leverandøren.

**ADVARSEL**

Lithiumbatteri - Eksplosjonsfare. Ved utskifting benyttes kun batteri som anbefalt av apparatfabrikanten. Brukt batteri returneres apparatleverandøren.

**WARNING**

Explosionsfara vid felaktigt batteribyte. Använd samma batterityp eller en ekvivalent typ som rekommenderas av apparattillverkaren. Kassera använt batteri enligt fabrikantens instruktion.

**VAROITUS**

Paristo voi räjähtää, jos se on virheellisesti asennettu. Vaihda paristo ainoastaan laitevalmistajan suosittelemaan tyyppiin. Hävitä käytetty paristo valmistajan ohjeiden mukaisesti.

10. Regulatory and Certification Information



WARNING

To ensure regulatory compliance, you must adhere to the assembly instructions in this document to ensure and maintain compliance with existing product certifications and approvals. Use only the described, regulated components specified in this document. Use of other products / components will void the UL listing and other regulatory approvals of the product and will most likely result in noncompliance with product regulations in the region(s) in which the product is sold.

To help ensure EMC compliance with your local regional rules and regulations, before computer integration, make sure that the chassis, power supply, and other modules have passed EMC testing using a server board with a microprocessor from the same family (or higher) and operating at the same (or higher) speed as the microprocessor used on this server board. The final configuration of your end system product may require additional EMC compliance testing. For more information please contact your local Intel Representative.

This is an FCC Class A device. Integration of it into a Class B chassis does not result in a Class B device.

10.1 Product Regulatory Compliance

The server chassis product, when correctly integrated per this document, complies with the following safety and electromagnetic compatibility (EMC) regulations.

Intended Application – This product was evaluated as Information Technology Equipment (ITE), which may be installed in offices, schools, computer rooms, and similar commercial type locations. The suitability of this product for other product categories and environments (such as medical, industrial, telecommunications, NEBS, residential, alarm systems, test equipment, etc.), other than an ITE application, may require further evaluation.

Note: The use and/or integration of telecommunication devices such as modems and/or wireless devices have not been planned for with respect to these systems. If there is any change of plan to use such devices, then telecommunication type certifications will require additional planning. If NEBS compliance is required for system level products, additional certification planning and design will be required.

10.1.1 Product Safety Compliance

- CSA 60950-1 Certification (Canada)
- UL 60950-1 Listing (USA)
- IEC60950-1 (International)
- CB Certificate & Report, IEC60950 (report to include all country national deviations)
- GS Certification (Germany – EN60950-1)
- GOST R 50377-92 - Certification (Russia)
- Ukraine Certification (Ukraine)

- CE Declaration to EU Low Voltage Directive 2006/95/EC (Europe – EN60950-1)
- IRAM Certification (Argentina)
- BSMI RPC Certification (Taiwan)

10.1.2 Product EMC Compliance – Class A Compliance

- FCC – Part 15 Emissions (USA) Verification
- ICES-003 – (Canada)
- CISPR 22 – Emissions (International)
- EN55022 - Emissions (Europe)
- EN55024 - Immunity (Europe)
- EN61000-3-2 - Harmonics (Europe)
- EN61000-3-3 - Voltage Flicker (Europe)
- CE – EMC Directive 2004/108/EC (Europe)
- VCCI Emissions (Japan)
- AS/NZS CISPR 22 Emissions (Australia / New Zealand)
- BSMI CNS13438 Emissions (Taiwan)
- GOST R 29216-91 Emissions (Russia)
- GOST R 50628-95 Immunity (Russia)
- Ukraine Certification (Ukraine)
- KCC MIC Notice No. 1997-41 (EMC) & 1997-42 (EMI) (Korea)

10.1.3 Product Ecology Compliance

Intel has a system in place to restrict the use of banned substances in accordance with world wide regulatory requirements. A Material Declaration Data Sheet is available for Intel products. For more reference on material restrictions and compliance you can view Intel's Environmental Product Content Specification at <http://supplier.intel.com/ehs/environmental.htm>.

- Europe - European Directive 2002/95/EC - Restriction of Hazardous Substances (RoHS) Threshold limits and banned substances are noted below.
Quantity limit of 0.1% by mass (1000 PPM) for:
Lead, Mercury, Hexavalent Chromium, Polybrominated Biphenyls Diphenyl Ethers (PBB/PBDE)
Quantity limit of 0.01% by mass (100 PPM) for:
Cadmium
- CA. Lithium Perchlorate insert
Perchlorate Material – Special handling may apply. See www.dtsc.ca.gov/hazardouswaste/perchlorate
This notice is required by California Code of Regulations, Title 22, Division 4.5, Chapter 33: Best Management Practices for Perchlorate Materials. This product / part includes a battery which contains Perchlorate material.
- China RoHS (MII Measure 39)
Product marked with the Environmental Friendly Usage Period (EFUP) label of 20yrs, substance table in Simplified Chinese either placed with the product documentation or separate insert.



- WEEE Directive (2002/96/EC)
- EU Packaging Directive (94/62/EC)
- All plastic parts that weigh >25gm shall be marked with the ISO11469 requirements for recycling. Example >PC/ABS<





10.1.4 Certifications/Registrations/Declarations





- NRTL Certification (US/Canada)
- CB Certification (International)
- CE Declaration of Conformity (CENELEC Europe)
- FCC/ICES-003 Class A Attestation (USA/Canada)
- VCCI Certification (Japan)
- C-Tick Declaration of Conformity (Australia)
- MED Declaration of Conformity (New Zealand)
- BSMI Certification (Taiwan)
- GOST R Certification / Certification (Russia)
- KCC Certification (Korea)
- IRAM Certification (Argentina)
- Ecology Declaration (International)
- China RoHS Environmental Friendly Use Period
- Packaging & Product Recycling Marks

10.2 Product Regulatory Compliance Markings

This Intel Server Chassis product is provided with the following regulatory and safety markings. In the event there is no room for a marking(s) on the chassis, the information is provided here in this document.

Regulatory Compliance	Country	Marking
cETLus Listing Marks	USA/Canada	
GS Mark	Germany	
CE Mark	Europe	

Regulatory Compliance	Country	Marking
IRAM Mark	Argentina	
Ctick Mark	Australia / NZ	 N232
Country of Origin Mark		Made in China
FCC Marking (Class A)	USA	This device complies with Part 15 of the FCC Rules. Operation of this device is subject to the following two conditions: (1) This device may not cause harmful interference, and (2) This device must accept interference receive, including interference that may cause undesired operation.
EMC Marking (Class A)	Canada	CANADA ICES-003 CLASS A
VCCI Marking (Class A)	Japan	この装置は、クラス A 情報技術装置です。この装置を家庭環境で使用すると電波妨害を引き起こすことがあります。この場合には使用者が適切な対策を講ずるよう要求されることがあります。VCCI-A
BSMI Certification Number & Class A Warning	Taiwan	 R33025 <div style="border: 1px solid black; padding: 5px; margin-top: 10px;">警告使用者： 這是甲類的資訊產品，在居住的環境中使用時，可能會造成射頻干擾，在這種情況下，使用者會被要求採取某些適當的對策</div>
GOST R Marking	Russia	 MO04
KCC Mark (Korean Communications Commission)	Korea	 인증번호: CPU-SR2612 (A)

Regulatory Compliance	Country	Marking	
Waste of Electronic and Electrical Equipment Recycling Mark	Europe		
China Restriction of Hazardous Substance Environmental Friendly Use Period Mark	China		
China Recycling Mark	China		
Recycling Marks	International		
Battery Perchlorate Warning Information	California	Perchlorate Material – Special handling may apply. See www.dtsc.ca.gov/hazardouswaste/perchlorate This notice is required by California Code of Regulations, Title 22, Division 4.5, and Chapter 33: Best Management Practices for Perchlorate Materials. This product may include a battery which contains Perchlorate material.	
Safety	Multiple Power Cord Marking	<p>English: This unit has more than one power supply cord. To reduce the risk of electrical shock, disconnect (2) two power supply cords before servicing.</p> <p>Simplified Chinese: 注意： 本设备包括多条电源系统电缆。为避免遭受电击，在进行维修之前应断开两（2）条电源系统电缆。</p> <p>Traditional Chinese: 注意： 本設備包括多條電源系統電纜。為避免遭受電擊，在進行維修之前應斷開兩（2）條電源系統電纜。</p> <p>German: Dieses Geräte hat mehr als ein Stromkabel. Um eine Gefahr des elektrischen Schlages zu verringern trennen sie beide (2) Stromkabeln bevor Instandhaltung.</p>	
Nordic Ground Marking	Connection to Proper Ground Outlet	<p>“WARNING:” “Apparaten skall anslutas till jordat uttag, när den ansluts till ett nätverk.” “Laite on liitettävä suojamaadoituskoskettimilla varustettuun pistorasiaan.” “Connect only to a properly earth grounded outlet.”</p>	

Regulatory Compliance	Country	Marking
Safety	Standard icon for Power button	

10.3 Rack Mount Installation Guidelines

Anchor the equipment rack: The equipment rack must be anchored to an unmovable support to prevent it from falling over when one or more servers are extended in front of the rack on slides. You must also consider the weight of any other device installed in the rack. A crush hazard exists should the rack tilt forward which could cause serious injury.

Temperature: The temperature, in which the server operates when installed in an equipment rack, must not go below 5 °C (41 °F) or rise above 40 °C (104 °F). Extreme fluctuations in temperature can cause a variety of problems in your server.

Ventilation: The equipment rack must provide sufficient airflow to the front of the server to maintain proper cooling. The rack must also include ventilation sufficient to exhaust a maximum of 1023 BTU's (British Thermal Units) per hour for the server. The rack selected and the ventilation provided must be suitable to the environment in which the server will be used.

If AC power supplies are installed:

Mains AC power disconnection: The AC power cord(s) is considered the mains disconnect for the server and must be readily accessible when installed. If the individual server power cord(s) will not be readily accessible for disconnection then you are responsible for installing an AC power disconnect for the entire rack unit. This main disconnect must be readily accessible, and it must be labeled as controlling power to the entire rack, not just to the server(s).

Grounding the rack installation: To avoid the potential for an electrical shock hazard, you must include a third wire safety ground conductor with the rack installation. If the server power cord is plugged into an AC outlet that is part of the rack, then you must provide proper grounding for the rack itself. If the server power cord is plugged into a wall AC outlet, the safety ground conductor in the power cord provides proper grounding only for the server. You must provide additional, proper grounding for the rack and other devices installed in it.

Overcurrent protection: The server is designed for an AC line voltage source with up to 20 amperes of overcurrent protection per cord feed. If the power system for the equipment rack is installed on a branch circuit with more than 20 amperes of protection, you must provide supplemental protection for the server.

If DC power supplies are installed:

Connection with a DC (Direct Current) source should only be performed by trained service personnel. The server with DC input is to be installed in a Restricted Access Location in accordance with articles 110-16, 110-17, and 110-18 of the National Electric Code, ANSI/NFPA 70. The DC source must be electrically isolated by double or reinforced insulation from any hazardous AC source.

Main DC power disconnect: You are responsible for installing a properly rated DC power disconnect for the server system. This mains disconnect must be readily accessible, and it must

be labeled as controlling power to the server. The circuit breaker of a centralized DC power system may be used as a disconnect device when easily accessible and should be rated no more than 10 amps.

Grounding the server: To avoid the potential for an electrical shock hazard, you must reliably connect an earth grounding conductor to the server. The earth grounding conductor must be a minimum 18AWG connected to the earth ground stud(s) on the rear of the server. The safety ground conductor should be connected to the chassis stud with a Listed closed two-hole crimp terminal having 5/8 inch pitch. The nuts on the chassis earth ground studs should be installed with a 10 in/lbs torque. The safety ground conductor provides proper grounding only for the server. You must provide additional, proper grounding for the rack and other devices installed in it.

Overcurrent protection: Overcurrent protection circuit breakers must be provided as part of each host equipment rack and must be incorporated in the field wiring between the DC source and the server. The branch circuit protection shall be rated minimum 75Vdc, 10 A maximum per feed pair. If the DC power system for the equipment rack is installed with more than 10 amperes of protection, you must provide supplemental protection for the server.

10.4 Power Cord Usage Guidelines



WARNING

Do not attempt to modify or use an AC power cord set that is not the exact type required. You must use a power cord set that meets the following criteria:

- **Rating:** In the U.S. and Canada, cords must be UL (Underwriters Laboratories, Inc.) Listed/CSA (Canadian Standards Organization) Certified type SJT, 18-3 AWG (American Wire Gauge). Outside of the U.S. and Canada, cords must be flexible harmonized (<HAR>) or VDE (Verband Deutscher Elektrotechniker, German Institute of Electrical Engineers) certified cord with 3 x 0.75 mm conductors rated 250 VAC (Volts Alternating Current).
- **Connector, wall outlet end:** Cords must be terminated in grounding-type male plug designed for use in your region. The connector must have certification marks showing certification by an agency acceptable in your region and for U.S. must be Listed and rated 125% of overall current rating of the server.
- **Connector, server end:** The connectors that plug into the AC receptacle on the server must be an approved IEC (International Electrotechnical Commission) 320, sheet C13, type female connector.
- **Cord length and flexibility:** Cords must be less than 4.5 meters (14.76 feet) long.

10.5 Electromagnetic Compatibility Notices

10.5.1 FCC Verification Statement (USA)

This device complies with Part 15 of the FCC Rules. Operation is subject to the following two conditions: (1) This device may not cause harmful interference, and (2) this device must accept any interference received, including interference that may cause undesired operation.

*Intel Corporation
5200 N.E. Elam Young Parkway
Hillsboro, OR 97124-6497
1-800-628-8686*

This equipment has been tested and found to comply with the limits for a Class A digital device, pursuant to Part 15 of the FCC Rules. These limits are designed to provide reasonable protection against harmful interference in a residential installation. This equipment generates, uses, and can radiate radio frequency energy and, if not installed and used in accordance with the instructions, may cause harmful interference to radio communications. However, there is no guarantee that interference will not occur in a particular installation. If this equipment does cause harmful interference to radio or television reception, which can be determined by turning the equipment off and on, the user is encouraged to try to correct the interference by one or more of the following measures:

- Reorient or relocate the receiving antenna.
- Increase the separation between the equipment and the receiver.
- Connect the equipment into an outlet on a circuit different from that to which the receiver is connected.
- Consult the dealer or an experienced radio/TV technician for help.

Any changes or modifications not expressly approved by the grantee of this device could void the user's authority to operate the equipment. The customer is responsible for ensuring compliance of the modified product.

Only peripherals (computer input/output devices, terminals, printers, etc.) that comply with FCC Class A or B limits may be attached to this computer product. Operation with noncompliant peripherals is likely to result in interference to radio and TV reception.

All cables used to connect to peripherals must be shielded and grounded. Operation with cables, connected to peripherals that are not shielded and grounded may result in interference to radio and TV reception.

10.5.2 ICES-003 (Canada)

Cet appareil numérique respecte les limites bruits radioélectriques applicables aux appareils numériques de Classe Aprescrites dans la norme sur le matériel brouilleur: "Appareils Numériques", NMB-003 édictée par le Ministre Canadien des Communications.

English translation of the notice above:

This digital apparatus does not exceed the Class A limits for radio noise emissions from digital apparatus set out in the interference-causing equipment standard entitled "Digital Apparatus," ICES-003 of the Canadian Department of Communications.

10.5.3 Europe (CE Declaration of Conformity)

This product has been tested in accordance too, and complies with the Low Voltage Directive (73/23/EEC) and EMC Directive (89/336/EEC). The product has been marked with the CE Mark to illustrate its compliance.

10.5.4 VCCI (Japan)

この装置は、情報処理装置等電波障害自主規制協議会（VCCI）の基準に基づくクラス A 情報技術装置です。この装置を家庭環境で使用すると電波妨害を引き起こすことがあります。この場合には使用者が適切な対策を講ずるよう要求されることがあります。

English translation of the notice above:

This is a Class A product based on the standard of the Voluntary Control Council for Interference (VCCI) from Information Technology Equipment. If this is used near a radio or television receiver in a domestic environment, it may cause radio interference. Install and use the equipment according to the instruction manual.

10.5.5 BSMI (Taiwan)

The BSMI Certification Marking and EMC warning is located on the outside rear area of the product.

警告使用者：
這是甲類的資訊產品，在居住的環境中使用時，可能會造成射頻干擾，在這種情況下，使用者會被要求採取某些適當的對策

10.5.6 KCC (Korea)

Following is the KCC certification information for Korea.



1. 기기의 명칭(모델명) :
2. 인증번호 :
3. 인증받은 자의 상호 :
4. 제조년월일:
5. 제조자/제조국가 :

English translation of the notice above:

1. Type of Equipment (Model Name): On Certification and Product
2. Certification No.: On KCC certificate. Obtain certificate from local Intel representative
3. Name of Certification Recipient: Intel Corporation
4. Date of Manufacturer: Refer to date code on product

5. Manufacturer/Nation: Intel Corporation/Refer to country of origin marked on product

10.6 Regulated Specified Components

To maintain the UL listing and compliance to other regulatory certifications and/or declarations, the following regulated components must be used and conditions adhered to. Interchanging or use of other component will void the UL listing and other product certifications and approvals.

Updated product information for configurations can be found on the Intel Server Builder Web site at the following URL:

<http://channel.intel.com/go/serverbuilder>

If you do not have access to Intel's Web address, please contact your local Intel representative.

- **Server chassis** (base chassis is provided with power supply and fans) — NRTL listed.
- **Server board** — you must use an Intel server board — UL recognized.
- **Add-in boards** — must have a printed wiring board flammability rating of minimum UL94V-1. Add-in boards containing external power connectors and/or lithium batteries must be UL recognized or UL listed. Any add-in board containing modem telecommunication circuitry must be UL listed. In addition, the modem must have the appropriate telecommunications, safety, and EMC approvals for the region in which it is sold.
- **Peripheral Storage Devices** — must be UL recognized or UL listed accessory and TUV or VDE licensed. Maximum power rating of any one device or combination of devices cannot exceed manufacturer's specifications. Total server configuration is not to exceed the maximum loading conditions of the power supply.

Appendix A: Integration and Usage Tips

This section provides a list of useful information unique to the Intel® Server System SR2612UR and should be kept in mind while integrating and configuring your Intel® Server Board S5520UR.

- Only low-profile (1.2 in or 30.48 mm) DIMMs can be used in the server system.
- Processor fans are not supported and are not needed in the server system. The system fan module and power supply fans provide the necessary cooling needed for the system. Using a processor fan in this system may cause Intel® System Management Software to incorrectly monitor the system fans.
- The CPU air duct must be used to maintain system thermals.
- To maintain system thermals, all hard drive bays must be populated with either a hard drive or drive blank.
- System fans are not hot-swappable
- Use of the screw found on the back edge of the top cover is required when the unit is installed in a user-accessible environment.
- The FRUSDR utility must be run to load the proper Sensor Data Records for the server chassis onto the server board.
- Make sure the latest system software is loaded on the server. This includes system BIOS, FRUSDR, Integrated BMC firmware, and hot-swap controller firmware. You can download the latest system software from the following website:
<http://support.intel.com/support/motherboards/server/s5520ur/>

Appendix B: POST Code Diagnostic LED Decoder

During the system boot process, the BIOS executes a number of platform configuration processes, each of which is assigned a specific hex POST code number. As each configuration routine is started, the BIOS displays the POST code to the POST Code Diagnostic LEDs on the back edge of the server board. To assist in troubleshooting a system hang during the POST process, you can use the Diagnostic LEDs to identify the last POST process executed.

Each POST code is represented by eight amber Diagnostic LEDs. The POST codes are divided into two nibbles: an upper nibble and a lower nibble. The upper nibble bits are represented by Diagnostic LEDs #4, #5, #6, and #7. The lower nibble bits are represented by Diagnostics LEDs #0, #1, #2 and #3. If the bit is set in the upper and lower nibbles, the corresponding LED is lit. If the bit is clear, the corresponding LED is off.

The Diagnostic LED #7 is labeled as “MSB” and the Diagnostic LED #0 is labeled as “LSB”.

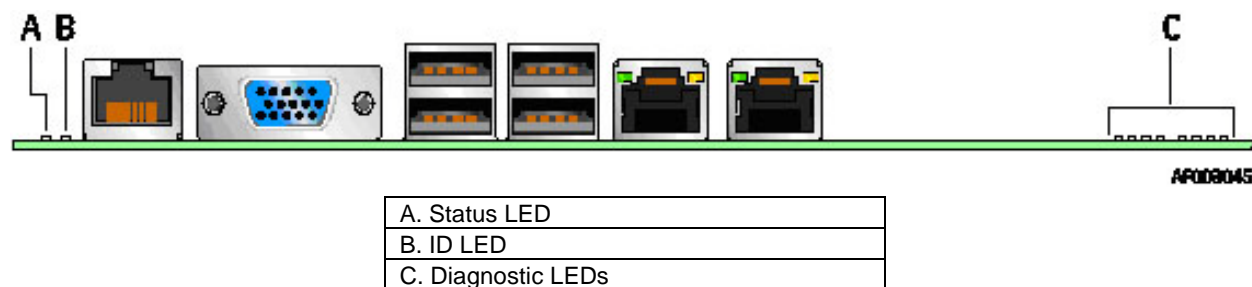

Figure 34. Diagnostic LED Placement Diagram

In the following example, the BIOS sends a value of ACh to the diagnostic LED decoder. The LEDs are decoded as follows:

Table 33. POST Progress Code LED Example

LEDs	Upper Nibble LEDs				Lower Nibble LEDs			
	MSB							LSB
	LED #7	LED #6	LED #5	LED #4	LED #3	LED #2	LED #1	LED #0
	8h	4h	2h	1h	8h	4h	2h	1h
Status	ON	OFF	ON	OFF	ON	OFF	ON	OFF
Results	1	0	1	0	1	1	0	0
	Ah				Ch			

- Upper nibble bits = 1010b = Ah; Lower nibble bits = 1100b = Ch; the two are concatenated as ACh.

Table 34. Diagnostic LED POST Code Decoder

Checkpoint	Diagnostic LED Decoder								Description
	O = On, X=Off								
	Upper Nibble				Lower Nibble				
	MSB							LSB	
LED	8h	4h	2h	1h	8h	4h	2h	1h	
	#7	#6	#5	#4	#3	#2	#1	#0	
Multi-use code (This POST Code is used in different contexts)									
0xF2h	O	O	O	O	X	X	O	X	Seen at the start of Memory Reference Code (MRC) Start of the very early platform initialization code Very late in POST, it is the signal that the OS has switched to virtual memory mode
Memory Error Codes (Accompanied by a beep code)									
0xE8h	O	O	O	X	O	X	X	X	No Usable Memory Error: No memory in the system, or SPD bad so no memory could be detected
0xEAh	O	O	O	X	O	X	O	X	Channel Training Error: DQ/DQS training failed on a channel during memory channel initialization.
0xEBh	O	O	O	X	O	X	O	O	Memory Test Error: memory failed Hardware BIST.
0xEDh	O	O	O	X	O	O	X	O	Population Error: RDIMMs and UDIMMs cannot be mixed in the system
0xEEh	O	O	O	X	O	O	O	X	Mismatch Error: more than 2 Quad Ranked DIMMS in a channel.
Memory Reference Code Progress Codes (Not accompanied by a beep code)									
0xB0h	O	X	O	O	X	X	X	X	Chipset Initialization Phase
0xB1h	O	X	O	O	X	X	X	O	Reset Phase
0xB2h	O	X	O	O	X	X	O	X	DIMM Detection Phase
0xB3h	O	X	O	O	X	X	O	O	Clock Initialization Phase
0xB4h	O	X	O	O	X	O	X	X	SPD Data Collection Phase
0xB6h	O	X	O	O	X	O	O	X	Rank Formation Phase
0xB8h	O	X	O	O	O	X	X	X	Channel Training Phase
0xB9h	O	X	O	O	O	X	X	O	Memory Test Phase
0xBAh	O	X	O	O	O	X	O	X	Memory Map Creation Phase
0xBBh	O	X	O	O	O	X	O	O	RAS Initialization Phase
0xBFh	O	X	O	O	O	O	O	O	MRC Complete
Host Processor									
0x04h	X	X	X	X	X	O	X	X	Early processor initialization where system BSP is selected
0x10h	X	X	X	O	X	X	X	X	Power-on initialization of the host processor (bootstrap processor)
0x11h	X	X	X	O	X	X	X	O	Host processor cache initialization (including AP)
0x12h	X	X	X	O	X	X	O	X	Starting application processor initialization
0x13h	X	X	X	O	X	X	O	O	SMM initialization
Chipset									
0x21h	X	X	O	X	X	X	X	O	Initializing a chipset component
Memory									
0x22h	X	X	O	X	X	X	O	X	Reading configuration data from memory (SPD on DIMM)
0x23h	X	X	O	X	X	X	O	O	Detecting presence of memory
0x24h	X	X	O	X	X	O	X	X	Programming timing parameters in the memory controller
0x25h	X	X	O	X	X	O	X	O	Configuring memory parameters in the memory controller
0x26h	X	X	O	X	X	O	O	X	Optimizing memory controller settings
0x27h	X	X	O	X	X	O	O	O	Initializing memory, such as ECC init
0x28h	X	X	O	X	O	X	X	X	Testing memory
PCI Bus									
0x50h	X	O	X	O	X	X	X	X	Enumerating PCI buses
0x51h	X	O	X	O	X	X	X	O	Allocating resources to PCI buses
0x52h	X	O	X	O	X	X	O	X	Hot Plug PCI controller initialization
0x53h	X	O	X	O	X	X	O	O	Reserved for PCI bus
0x54h	X	O	X	O	X	O	X	X	Reserved for PCI bus
0x55h	X	O	X	O	X	O	X	O	Reserved for PCI bus
0x56h	X	O	X	O	X	O	O	X	Reserved for PCI bus

Checkpoint	Diagnostic LED Decoder								Description
	O = On, X=Off								
	Upper Nibble				Lower Nibble				
	MSB							LSB	
LED	8h	4h	2h	1h	8h	4h	2h	1h	
	#7	#6	#5	#4	#3	#2	#1	#0	
0x57h	X	O	X	O	X	O	O	O	Reserved for PCI bus
USB									
0x58h	X	O	X	O	O	X	X	X	Resetting USB bus
0x59h	X	O	X	O	O	X	X	O	Reserved for USB devices
ATA/ATAPI/SATA									
0x5Ah	X	O	X	O	O	X	O	X	Resetting SATA bus and all devices
0x5Bh	X	O	X	O	O	X	O	O	Reserved for ATA
SMBUS									
0x5Ch	X	O	X	O	O	O	X	X	Resetting SMBUS
0x5Dh	X	O	X	O	O	O	X	O	Reserved for SMBUS
Local Console									
0x70h	X	O	O	O	X	X	X	X	Resetting the video controller (VGA)
0x71h	X	O	O	O	X	X	X	O	Disabling the video controller (VGA)
0x72h	X	O	O	O	X	X	O	X	Enabling the video controller (VGA)
Remote Console									
0x78h	X	O	O	O	O	X	X	X	Resetting the console controller
0x79h	X	O	O	O	O	X	X	O	Disabling the console controller
0x7Ah	X	O	O	O	O	X	O	X	Enabling the console controller
Keyboard (only USB)									
0x90h	O	X	X	O	X	X	X	X	Resetting the keyboard
0x91h	O	X	X	O	X	X	X	O	Disabling the keyboard
0x92h	O	X	X	O	X	X	O	X	Detecting the presence of the keyboard
0x93h	O	X	X	O	X	X	O	O	Enabling the keyboard
0x94h	O	X	X	O	X	O	X	X	Clearing keyboard input buffer
0x95h	O	X	X	O	X	O	X	O	Instructing keyboard controller to run Self Test (PS/2 only)
Mouse (only USB)									
0x98h	O	X	X	O	O	X	X	X	Resetting the mouse
0x99h	O	X	X	O	O	X	X	O	Detecting the mouse
0x9Ah	O	X	X	O	O	X	O	X	Detecting the presence of mouse
0x9Bh	O	X	X	O	O	X	O	O	Enabling the mouse
Fixed Media									
0xB0h	O	X	O	O	X	X	X	X	Resetting fixed media device
0xB1h	O	X	O	O	X	X	X	O	Disabling fixed media device
0xB2h	O	X	O	O	X	X	O	X	Detecting presence of a fixed media device (hard drive detection, and so forth)
0xB3h	O	X	O	O	X	X	O	O	Enabling / configuring a fixed media device
Removable Media									
0xB8h	O	X	O	O	O	X	X	X	Resetting removable media device
0xB9h	O	X	O	O	O	X	X	O	Disabling removable media device
0xBAh	O	X	O	O	O	X	O	X	Detecting presence of a removable media device (CD-ROM detection, and so forth)
0xBCh	O	X	O	O	O	O	X	X	Enabling / configuring a removable media device
Boot Device Selection (BDS)									
0xD0	O	O	X	O	X	X	X	X	Trying to boot device selection 0
0xD1	O	O	X	O	X	X	X	O	Trying to boot device selection 1
0xD2	O	O	X	O	X	X	O	X	Trying to boot device selection 2
0xD3	O	O	X	O	X	X	O	O	Trying to boot device selection 3
0xD4	O	O	X	O	X	O	X	X	Trying to boot device selection 4
0xD5	O	O	X	O	X	O	X	O	Trying to boot device selection 5
0xD6	O	O	X	O	X	O	O	X	Trying to boot device selection 6
0xD7	O	O	X	O	X	O	O	O	Trying to boot device selection 7
0xD8	O	O	X	O	O	X	X	X	Trying to boot device selection 8

Checkpoint	Diagnostic LED Decoder								Description
	O = On, X=Off								
	Upper Nibble				Lower Nibble				
	MSB				LSB				
LED	8h	4h	2h	1h	8h	4h	2h	1h	
	#7	#6	#5	#4	#3	#2	#1	#0	
0xD9	O	O	X	O	O	X	X	O	Trying to boot device selection 9
0xDA	O	O	X	O	O	X	O	X	Trying to boot device selection A
0xDB	O	O	X	O	O	X	O	O	Trying to boot device selection B
0xDC	O	O	X	O	O	O	X	X	Trying to boot device selection C
0xDD	O	O	X	O	O	O	X	O	Trying to boot device selection D
0xDE	O	O	X	O	O	O	O	X	Trying to boot device selection E
0xDF	O	O	X	O	O	O	O	O	Trying to boot device selection F
Pre-EFI Initialization (PEI) Core									
0xE0h	O	O	O	X	X	X	X	X	Started dispatching early initialization modules (PEIM)
0xE1h	O	O	O	X	X	X	X	O	Reserved for initialization module use (PEIM)
0xE2h	O	O	O	X	X	X	O	X	Initial memory found, configured, and installed correctly
0xE3h	O	O	O	X	X	X	O	O	Reserved for initialization module use (PEIM)
Driver eXecution Environment (DXE) Core (not accompanied by a beep code)									
0xE4h	O	O	O	X	X	O	X	X	Entered EFI driver execution phase (DXE)
0xE5h	O	O	O	X	X	O	X	O	Started dispatching drivers
0xE6h	O	O	O	X	X	O	O	X	Started connecting drivers
DXE Drivers									
0xE7h	O	O	O	X	O	O	X	O	Waiting for user input
0xE8h	O	O	O	X	O	X	X	X	Checking password
0xE9h	O	O	O	X	O	X	X	O	Entering BIOS setup
0xEAh	O	O	O	X	O	X	O	X	Flash Update
0xEEh	O	O	O	X	O	O	O	X	Calling Int 19. One beep unless silent boot is enabled.
0xEFh	O	O	O	X	O	O	O	O	Unrecoverable boot failure
Runtime Phase / EFI Operating System Boot									
0xF2h	O	O	O	O	X	X	O	X	Signal that the OS has switched to virtual memory mode
0xF4h	O	O	O	O	X	O	X	X	Entering Sleep state
0xF5h	O	O	O	O	X	O	X	O	Exiting Sleep state
0xF8h	O	O	O	O	O	X	X	X	Operating system has requested EFI to close boot services (ExitBootServices () Has been called)
0xF9h	O	O	O	O	O	X	X	O	Operating system has switched to virtual address mode (SetVirtualAddressMap () Has been called)
0xFAh	O	O	O	O	O	X	O	X	Operating system has requested the system to reset (ResetSystem () has been called)
Pre-EFI Initialization Module (PEIM) / Recovery									
0x30h	X	X	O	O	X	X	X	X	Crisis recovery has been initiated because of a user request
0x31h	X	X	O	O	X	X	X	O	Crisis recovery has been initiated by software (corrupt flash)
0x34h	X	X	O	O	X	O	X	X	Loading crisis recovery capsule
0x35h	X	X	O	O	X	O	X	O	Handing off control to the crisis recovery capsule
0x3Fh	X	X	O	O	O	O	O	O	Unable to complete crisis recovery capsule

Appendix C: POST Code Errors

Whenever possible, the BIOS outputs the current boot progress codes on the video screen. Progress codes are 32-bit quantities plus optional data. The 32-bit numbers include class, subclass, and operation information. The class and subclass fields point to the type of hardware being initialized. The operation field represents the specific initialization activity. Based on the data bit availability to display progress codes, you can customize a progress code to fit the data width. The higher the data bit, the higher the granularity of information that can be sent on the progress port. The progress codes may be reported by the system BIOS or option ROMs.

The Response section in the following table is divided into three types:

- **No Pause:** The message is displayed on the screen during POST or in the Error Manager. The system continues booting with a degraded state. The user may want to replace the erroneous unit. The setup POST error Pause setting does not have any effect with this error.
- **Pause:** The message is displayed on the Error Manager screen, and an error is logged to the SEL. The setup POST error Pause setting determines whether the system pauses to the Error Manager for this type of error, where the user can take immediate corrective action or choose to continue booting.
- **Halt:** The message is displayed on the Error Manager screen, an error is logged to the SEL, and the system cannot boot unless the error is resolved. The user needs to replace the faulty part and restart the system. The setup POST error Pause setting does not have any effect with this error.

Table 35. POST Error Messages and Handling

Error Code	Error Message	Response
0012	CMOS date / time not set	Pause
0048	Password check failed	Halt
0108	Keyboard component encountered a locked error.	No Pause
0109	Keyboard component encountered a stuck key error.	No Pause
0113	Fixed Media The SAS RAID firmware cannot run properly. The user should attempt to reflash the firmware.	Pause
0140	PCI component encountered a PERR error.	Pause
0141	PCI resource conflict	Pause
0146	PCI out of resources error	Pause
0192	L3 cache size mismatch	Halt
0194	CPUID, processor family are different	Halt
0195	Front side bus mismatch	Pause
0196	Processor Model mismatch	Pause
0197	Processor speeds mismatched	Pause
0198	Processor family is unsupported.	Pause
019F	Processor and chipset stepping configuration is unsupported.	Pause
5220	CMOS/NVRAM Configuration Cleared	Pause
5221	Passwords cleared by jumper	Pause
5224	Password clear Jumper is Set.	Pause
8110	Processor 01 internal error (IERR) on last boot	Pause
8111	Processor 02 internal error (IERR) on last boot	Pause
8120	Processor 01 thermal trip error on last boot	Pause
8121	Processor 02 thermal trip error on last boot	Pause
8130	Processor 01 disabled	Pause
8131	Processor 02 disabled	Pause

Error Code	Error Message	Response
8140	Processor 01 Failed FRB-3 Timer.	No Pause
8141	Processor 02 Failed FRB-3 Timer.	No Pause
8160	Processor 01 unable to apply BIOS update	Pause
8161	Processor 02 unable to apply BIOS update	Pause
8170	Processor 01 failed Self Test (BIST).	Pause
8171	Processor 02 failed Self Test (BIST).	Pause
8180	Processor 01 BIOS does not support the current stepping for processor	No Pause
8181	Processor 02 BIOS does not support the current stepping for processor	No Pause
8190	Watchdog timer failed on last boot	Pause
8198	Operating system boot watchdog timer expired on last boot	Pause
8300	Integrated Baseboard Management Controller failed self-test	Pause
84F2	Integrated Baseboard Management Controller failed to respond	Pause
84F3	Integrated Baseboard Management Controller in update mode	Pause
84F4	Sensor data record empty	Pause
84FF	System event log full	No Pause
8500	Memory component could not be configured in the selected RAS mode.	Pause
8520	DIMM_A1 failed Self Test (BIST).	Pause
8521	DIMM_A2 failed Self Test (BIST).	Pause
8522	DIMM_A3 failed Self Test (BIST).	Pause
8523	DIMM_A4 failed Self Test (BIST).	Pause
8524	DIMM_B1 failed Self Test (BIST).	Pause
8525	DIMM_B2 failed Self Test (BIST).	Pause
8526	DIMM_B3 failed Self Test (BIST).	Pause
8527	DIMM_B4 failed Self Test (BIST).	Pause
8528	DIMM_C1 failed Self Test (BIST).	Pause
8529	DIMM_C2 failed Self Test (BIST).	Pause
852A	DIMM_C3 failed Self Test (BIST).	Pause
852B	DIMM_C4 failed Self Test (BIST).	Pause
852C	DIMM_D1 failed Self Test (BIST).	Pause
852D	DIMM_D2 failed Self Test (BIST).	Pause
852E	DIMM_D3 failed Self Test (BIST).	Pause
852F	DIMM_D4 failed Self Test (BIST).	Pause
8540	DIMM_A1 Disabled.	Pause
8541	DIMM_A2 Disabled.	Pause
8542	DIMM_A3 Disabled.	Pause
8543	DIMM_A4 Disabled.	Pause
8544	DIMM_B1 Disabled.	Pause
8545	DIMM_B2 Disabled.	Pause
8546	DIMM_B3 Disabled.	Pause
8547	DIMM_B4 Disabled.	Pause
8548	DIMM_C1 Disabled.	Pause
8549	DIMM_C2 Disabled.	Pause
854A	DIMM_C3 Disabled.	Pause
854B	DIMM_C4 Disabled.	Pause
854C	DIMM_D1 Disabled.	Pause
854D	DIMM_D2 Disabled.	Pause
854E	DIMM_D3 Disabled.	Pause
854F	DIMM_D4 Disabled.	Pause
8560	DIMM_A1 Component encountered a Serial Presence Detection (SPD) fail error.	Pause
8561	DIMM_A2 Component encountered a Serial Presence Detection (SPD) fail error.	Pause
8562	DIMM_A3 Component encountered a Serial Presence Detection (SPD) fail error.	Pause
8563	DIMM_A4 Component encountered a Serial Presence Detection (SPD) fail error.	Pause
8564	DIMM_B1 Component encountered a Serial Presence Detection (SPD) fail error.	Pause
8565	DIMM_B2 Component encountered a Serial Presence Detection (SPD) fail error.	Pause
8566	DIMM_B3 Component encountered a Serial Presence Detection (SPD) fail error.	Pause
8567	DIMM_B4 Component encountered a Serial Presence Detection (SPD) fail error.	Pause
8568	DIMM_C1 Component encountered a Serial Presence Detection (SPD) fail error.	Pause
8569	DIMM_C2 Component encountered a Serial Presence Detection (SPD) fail error.	Pause

Error Code	Error Message	Response
856A	DIMM_C3 Component encountered a Serial Presence Detection (SPD) fail error.	Pause
856B	DIMM_C4 Component encountered a Serial Presence Detection (SPD) fail error.	Pause
856C	DIMM_D1 Component encountered a Serial Presence Detection (SPD) fail error.	Pause
856D	DIMM_D2 Component encountered a Serial Presence Detection (SPD) fail error.	Pause
856E	DIMM_D3 Component encountered a Serial Presence Detection (SPD) fail error.	Pause
856F	DIMM_D4 Component encountered a Serial Presence Detection (SPD) fail error.	Pause
8580	DIMM_A1 Correctable ECC error encountered.	Pause after 10 occurrences
8581	DIMM_A2 Correctable ECC error encountered.	Pause after 10 occurrences
8582	DIMM_A3 Correctable ECC error encountered.	Pause after 10 occurrences
8583	DIMM_A4 Correctable ECC error encountered.	Pause after 10 occurrences
8584	DIMM_B1 Correctable ECC error encountered.	Pause after 10 occurrences
8585	DIMM_B2 Correctable ECC error encountered.	Pause after 10 occurrences
8586	DIMM_B3 Correctable ECC error encountered.	Pause after 10 occurrences
8587	DIMM_B4 Correctable ECC error encountered.	Pause after 10 occurrences
8588	DIMM_C1 Correctable ECC error encountered.	Pause after 10 occurrences
8589	DIMM_C2 Correctable ECC error encountered.	Pause after 10 occurrences
858A	DIMM_C3 Correctable ECC error encountered.	Pause after 10 occurrences
858B	DIMM_C4 Correctable ECC error encountered.	Pause after 10 occurrences
858C	DIMM_D1 Correctable ECC error encountered.	Pause after 10 occurrences
858D	DIMM_D2 Correctable ECC error encountered.	Pause after 10 occurrences
858E	DIMM_D3 Correctable ECC error encountered.	Pause after 10 occurrences
858F	DIMM_D4 Correctable ECC error encountered.	Pause after 10 occurrences
85A0	DIMM_A1 Uncorrectable ECC error encountered.	Pause
85A1	DIMM_A2 Uncorrectable ECC error encountered.	Pause
85A2	DIMM_A3 Uncorrectable ECC error encountered.	Pause
85A3	DIMM_A4 Uncorrectable ECC error encountered.	Pause
85A4	DIMM_B1 Uncorrectable ECC error encountered.	Pause
85A5	DIMM_B2 Uncorrectable ECC error encountered.	Pause
85A6	DIMM_B3 Uncorrectable ECC error encountered.	Pause
85A7	DIMM_B4 Uncorrectable ECC error encountered.	Pause
85A8	DIMM_C1 Uncorrectable ECC error encountered.	Pause
85A9	DIMM_C2 Uncorrectable ECC error encountered.	Pause
85AA	DIMM_C3 Uncorrectable ECC error encountered.	Pause
85AB	DIMM_C4 Uncorrectable ECC error encountered.	Pause
85AC	DIMM_D1 Uncorrectable ECC error encountered.	Pause
85AD	DIMM_D2 Uncorrectable ECC error encountered.	Pause
85AE	DIMM_D3 Uncorrectable ECC error encountered.	Pause
85AF	DIMM_D4 Uncorrectable ECC error encountered.	Pause
8601	Override jumper is set to force boot from lower alternate BIOS bank of flash ROM	No Pause
8602	WatchDog timer expired (secondary BIOS may be bad!)	No Pause
8603	Secondary BIOS checksum fail	No Pause
8604	Chipset Reclaim of non critical variables complete.	No Pause
9000	Unspecified processor component has encountered a non specific error.	Pause
9223	Keyboard component was not detected.	No Pause
9226	Keyboard component encountered a controller error.	No Pause
9243	Mouse component was not detected.	No Pause
9246	Mouse component encountered a controller error.	No Pause
9266	Local Console component encountered a controller error.	No Pause
9268	Local Console component encountered an output error.	No Pause
9269	Local Console component encountered a resource conflict error.	No Pause
9286	Remote Console component encountered a controller error.	No Pause
9287	Remote Console component encountered an input error.	No Pause
9288	Remote Console component encountered an output error.	No Pause
92A3	Serial port component was not detected	Pause
92A9	Serial port component encountered a resource conflict error	Pause
92C6	Serial Port controller error	No Pause
92C7	Serial Port component encountered an input error.	No Pause
92C8	Serial Port component encountered an output error.	No Pause

Error Code	Error Message	Response
94C6	LPC component encountered a controller error.	No Pause
94C9	LPC component encountered a resource conflict error.	Pause
9506	ATA/ATPI component encountered a controller error.	No Pause
95A6	PCI component encountered a controller error.	No Pause
95A7	PCI component encountered a read error.	No Pause
95A8	PCI component encountered a write error.	No Pause
9609	Unspecified software component encountered a start error.	No Pause
9641	PEI Core component encountered a load error.	No Pause
9667	PEI module component encountered an illegal software state error.	Halt
9687	DXE core component encountered an illegal software state error.	Halt
96A7	DXE boot services driver component encountered an illegal software state error.	Halt
96AB	DXE boot services driver component encountered invalid configuration.	No Pause
96E7	SMM driver component encountered an illegal software state error.	Halt
0xA022	Processor component encountered a mismatch error.	Pause
0xA027	Processor component encountered a low voltage error.	No Pause
0xA028	Processor component encountered a high voltage error.	No Pause
0xA421	PCI component encountered a SERR error.	Halt
0xA500	ATA/ATPI ATA bus SMART not supported.	No Pause
0xA501	ATA/ATPI ATA SMART is disabled.	No Pause
0xA5A0	PCI Express* component encountered a PERR error.	No Pause
0xA5A1	PCI Express* component encountered a SERR error.	Halt
0xA5A4	PCI Express* IBIST error.	Pause
0xA6A0	DXE boot services driver Not enough memory available to shadow a legacy option ROM.	No Pause

POST Error Beep Codes

The following table lists the POST error beep codes. Prior to system video initialization, the BIOS uses these beep codes to inform users on error conditions. The beep code is followed by a user-visible code on the POST Progress LEDs. For complete details, refer to the *Intel® S5500/S5520 Server Board Family BIOS External Product Specification*.

Table 36. POST Error Beep Codes

Beeps	Error Message	POST Progress Code	Description
3	Memory error	0xE8, 0xEB, 0xED, 0xEE	System halted because a fatal error related to the memory was detected.

The Integrated BMC may generate beep codes upon detection of failure conditions. Beep codes are sounded each time the problem is discovered, such as on each power-up attempt, but are not sounded continuously. Codes that are common across all Intel server boards and systems that use same generation chipset are listed in the following table. Each digit in the code is represented by a sequence of beeps whose count is equal to the digit. For complete details, refer to the *Intel® Server System Integrated Baseboard Management Controller Core External Product Specification*.

Table 37. Integrated BMC Beep Codes

Code	Reason for Beep	Associated Sensors	Supported
1-5-2-1	No CPUs installed or first CPU socket is empty.	CPU Missing Sensor	Yes
1-5-4-2	Power fault: DC power unexpectedly lost (power good dropout).	Power unit – power unit failure offset.	Yes
1-5-4-4	Power control fault (power good assertion timeout).	Power unit – soft power control failure offset.	Yes

Glossary

Word / Acronym	Definition
ACA	Australian Communication Authority
ACPI	Advanced Configuration and Power Interface
ANSI	American National Standards Institute
ATA	Advanced Technology Attachment
BMC	Baseboard Management Controller
BIOS	Basic Input/Output System
CMOS	Complementary Metal-oxide-semiconductor
D2D	DC-to-DC
EMC	Electromagnetic Compatibility
EMP	Emergency Management Port
ESD	Electrostatic Discharge
FP	Front Panel
FRB	Fault Resilient Boot
FRU	Field Replaceable Unit
I ² C	Inter-integrated Circuit bus
IPMI	Intelligent Platform Management Interface
LCD	Liquid Crystal Display
LPC	Low-pin Count
LSB	Least Significant Bit
MSB	Most Significant Bit
MTBF	Mean Time Between Failure
MTTR	Mean Time to Repair
NIC	Network Interface Card
NMI	Non-maskable Interrupt
OTP	Over-temperature Protection
OVP	Over-voltage Protection
PCI	Peripheral Component Interconnect
PCB	Printed Circuit Board
PCIe*	Peripheral Component Interconnect Express*
PCI-X	Peripheral Component Interconnect Extended
PFC	Power Factor Correction
POST	Power-on Self Test
PSU	Power Supply Unit
RAID	Redundant Array of Independent (or Inexpensive) Disks
RAM	Random Access Memory
RI	Ring Indicate
SATA	Serial Advanced Technology Attachment
SCA	Single Connector Attachment
SDR	Sensor Data Record
SE	Single-Ended
SMBus	System Management Bus
THD	Total Harmonic Distortion
UART	Universal Asynchronous Receiver Transmitter

Word / Acronym	Definition
USB	Universal Serial Bus
VCCI	Voluntary Control Council for Interference
VRD	Voltage Regulator Down
VSB	Voltage Standby

Reference Documents

Refer to the following documents for additional information:

- *Intel® Server Board S5520UR Technical Product Specification*