

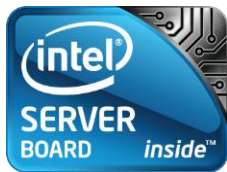

# Intel® Server Board S2400SC

## *Technical Product Specification*



*Intel order number G36516-001*

**Revision 1.1**

**May, 2012**

**Enterprise Platforms and Services Division – Marketing**

---

## **Revision History**

Date	Revision Number	Modifications
April 2012	1.0	Initial release.
May 2012	1.1	Updated the following: <ul style="list-style-type: none"> <li>▪ Figure 7</li> <li>▪ Tables 16, 58, and 59</li> <li>▪ Section 3.2.2</li> <li>▪ Section 6.11.4</li> </ul>

## **Disclaimers**

Information in this document is provided in connection with Intel® products. No license, express or implied, by estoppel or otherwise, to any intellectual property rights is granted by this document. Except as provided in Intel's Terms and Conditions of Sale for such products, Intel assumes no liability whatsoever, and Intel disclaims any express or implied warranty, relating to sale and/or use of Intel products including liability or warranties relating to fitness for a particular purpose, merchantability, or infringement of any patent, copyright or other intellectual property right. Intel products are not intended for use in medical, lifesaving, or life sustaining applications. Intel may make changes to specifications and product descriptions at any time, without notice.

Designers must not rely on the absence or characteristics of any features or instructions marked "reserved" or "undefined." Intel reserves these for future definition and shall have no responsibility whatsoever for conflicts or incompatibilities arising from future changes to them.

The Intel® Server Board S2400SC may contain design defects or errors known as errata which may cause the product to deviate from published specifications. Current characterized errata are available on request.

Intel Corporation server baseboards contain a number of high-density VLSI and power delivery components that need adequate airflow to cool. Intel's own chassis are designed and tested to meet the intended thermal requirements of these components when the fully integrated system is used together. It is the responsibility of the system integrator that chooses not to use Intel developed server building blocks to consult vendor datasheets and operating parameters to determine the amount of air flow required for their specific application and environmental conditions. Intel Corporation cannot be held responsible if components fail or the server board does not operate correctly when used outside any of their published operating or non-operating limits.

Intel, Pentium, Itanium, and Xeon are trademarks or registered trademarks of Intel Corporation.

\*Other brands and names may be claimed as the property of others.

Copyright © Intel Corporation 2012.

## Table of Contents

<b>1. Introduction</b>	<b>1</b>
1.1 Chapter Outline	1
1.2 Server Board Use Disclaimer	1
<b>2. Overview</b>	<b>2</b>
2.1 Intel® Server Boards S2400SC Feature Set	2
2.2 Server Board Layout	4
2.2.1 Server Board Connector and Component Layout	4
2.2.2 Server Board Mechanical Drawings	7
2.2.3 Server Board Rear I/O Layout	14
<b>3. Functional Architecture</b>	<b>16</b>
3.1 Processor Support	16
3.1.1 Processor Socket Assembly	17
3.1.2 Processor Population rules	17
3.2 Processor Function Overview	21
3.2.1 Intel® QuickPath Interconnect	22
3.2.2 Integrated Memory Controller (IMC) and Memory Subsystem	22
3.2.3 Processor Integrated I/O Module (IIO)	31
3.3 Intel® C602-A Chipset Functional Overview	33
3.3.1 Digital Media Interface (DMI)	34
3.3.2 PCI Express* Interface	34
3.3.3 Serial ATA (SATA) Controller	34
3.3.4 AHCI	35
3.3.5 Rapid Storage Technology	35
3.3.6 PCI Interface	35
3.3.7 Low Pin Count (LPC) Interface	35
3.3.8 Serial Peripheral Interface (SPI)	35
3.3.9 Compatibility Modules (DMA Controller, Timer/Counters, Interrupt Controller)	35
3.3.10 Advanced Programmable Interrupt Controller (APIC)	36
3.3.11 Universal Serial Bus (USB) Controller	36
3.3.12 Gigabit Ethernet Controller	36
3.3.13 RTC	37
3.3.14 GPIO	37
3.3.15 Enhanced Power Management	37
3.3.16 Manageability	37
3.3.17 System Management Bus (SMBus* 2.0)	38
3.3.18 Intel® Active Management Technology (Intel® AMT)	38

3.3.19	Integrated NVSRAM Controller .....	38
3.3.20	Intel® Virtualization Technology for Direct I/O (Intel® VT-d).....	38
3.3.21	JTAG Boundary-Scan .....	38
3.3.22	KVM/Serial Over LAN (SOL) Function.....	38
3.3.23	On-board Serial Attached SCSI (SAS)/Serial ATA (SATA) Support and Options..	39
3.4	Integrated Baseboard Management Controller (BMC) Overview .....	41
3.4.1	Super I/O Controller .....	42
3.4.2	Graphics Controller and Video Support .....	43
3.4.3	Baseboard Management Controller.....	44
<b>4.</b>	<b>System Security.....</b>	<b>46</b>
4.1	BIOS Password Protection .....	46
4.2	Trusted Platform Module (TPM) Support.....	47
4.2.1	TPM security BIOS.....	47
4.2.2	Physical Presence.....	48
4.2.3	TPM Security Setup Options .....	48
4.3	Intel® Trusted Execution Technology.....	50
<b>5.</b>	<b>Technology Support.....</b>	<b>52</b>
5.1	Intel® Trusted Execution Technology.....	52
5.2	Intel® Virtualization Technology – Intel® VT-x/VT-d/VT-c .....	52
5.3	Intel® Intelligent Power Node Manager .....	53
5.3.1	Hardware Requirements .....	54
<b>6.</b>	<b>Platform Management Functional Overview.....</b>	<b>55</b>
6.1	Baseboard Management Controller (BMC) Firmware Feature Support.....	55
6.1.1	IPMI 2.0 Features.....	55
	Non IPMI Features .....	56
6.1.2	New Manageability Features .....	57
6.2	Basic and Advanced Features.....	58
6.3	Integrated BMC Hardware: Emulex* Pilot III .....	59
6.3.1	Emulex* Pilot III Baseboard Management Controller Functionality .....	59
6.4	Advanced Configuration and Power Interface (ACPI) .....	60
6.5	Power Control Sources .....	60
6.6	BMC Watchdog .....	61
6.7	Fault Resilient Booting (FRB) .....	61
6.8	Sensor Monitoring .....	62
6.9	Field Replaceable Unit (FRU) Inventory Device .....	62
6.10	System Event Log (SEL) .....	63
6.11	System Fan Management .....	63
6.11.1	Thermal and Acoustic Management .....	63
6.11.2	Setting Throttling Mode .....	64
6.11.3	Altitude.....	64
6.11.4	Set Fan Profile .....	64

6.11.5	Fan PWM Offset.....	64
6.11.6	Quiet Fan Idle Mode.....	64
6.11.7	Fan Profiles.....	65
6.11.8	Thermal Sensor Input to Fan Speed Control .....	66
6.11.9	Memory Thermal Throttling .....	67
6.12	Messaging Interfaces .....	68
6.12.1	User Model.....	68
6.12.2	IPMB Communication Interface.....	68
6.12.3	LAN Interface .....	69
6.12.4	Address Resolution Protocol (ARP).....	74
6.12.5	Internet Control Message Protocol (ICMP) .....	74
6.12.6	Virtual Local Area Network (VLAN) .....	74
6.12.7	Secure Shell (SSH) .....	75
6.12.8	Serial-over-LAN (SOL 2.0) .....	75
6.12.9	Platform Event Filter (PEF).....	76
6.12.10	LAN Alerting.....	76
6.12.11	Alert Policy Table .....	77
6.12.12	SM-CLP (SM-CLP Lite).....	77
6.12.13	Embedded Web Server.....	78
6.12.14	Virtual Front Panel .....	79
6.12.15	Embedded Platform Debug .....	80
6.12.16	Data Center Management Interface (DCMI) .....	82
6.12.17	Lightweight Directory Authentication Protocol (LDAP) .....	82
<b>7.</b>	<b>Advanced Management Feature Support (RMM4).....</b>	<b>83</b>
7.1	Keyboard, Video, Mouse (KVM) Redirection .....	84
7.1.1	Remote Console .....	85
7.1.2	Performance .....	85
7.1.3	Security .....	85
7.1.4	Availability .....	86
7.1.5	Usage .....	86
7.1.6	Force-enter BIOS Setup.....	86
7.2	Media Redirection .....	86
7.2.1	Availability .....	87
7.2.2	Network Port Usage .....	87
<b>8.</b>	<b>On-board Connector/Header Overview .....</b>	<b>88</b>
8.1	Board Connector Information .....	88
8.2	Power Connectors.....	89
8.3	System Management Headers .....	90
8.3.1	Intel® Remote Management Module 4 Connector.....	90
8.3.2	TPM connector.....	90
8.3.3	LCP Header .....	91

8.3.4	HSBP Header.....	91
8.3.5	SATA SGPIO Header .....	91
8.4	Front Panel Connector .....	91
8.5	I/O Connectors .....	92
8.5.1	VGA Connector .....	92
8.5.2	SATA Connectors .....	93
8.5.3	Serial Port Connectors .....	94
8.5.4	USB Connector .....	94
8.6	Fan Headers .....	95
<b>9.</b>	<b>Jumper Blocks.....</b>	<b>97</b>
9.1	BIOS Default (CMOS Clear) and Password Clear Usage Procedure.....	98
9.1.1	Clearing CMOS (BIOS default).....	98
9.1.2	Clearing the Password .....	99
9.2	Force BMC Update Procedure .....	99
9.3	ME Force Update Jumper .....	100
9.4	BIOS Recovery Jumper.....	100
<b>10.</b>	<b>Intel® Light Guided Diagnostics .....</b>	<b>102</b>
10.1	5 V Stand-by LED .....	102
10.2	Fan Fault LEDs .....	103
10.3	CPU Fault LEDs.....	104
10.4	System Status LED .....	105
10.5	DIMM Fault LEDs.....	108
10.6	BMC Boot/Reset Status LED Indicators .....	109
10.7	Post Code Diagnostic LEDs .....	110
<b>11.</b>	<b>Environmental Limits Specification .....</b>	<b>111</b>
11.1	Processor Thermal Design Power (TDP) Support .....	111
11.2	MTBF .....	112
11.3	Server Board Power Distribution .....	112
	<b>Appendix A: Integration and Usage Tips .....</b>	<b>114</b>
	<b>Appendix B: Integrated BMC Sensor Tables.....</b>	<b>115</b>
	<b>Appendix C: POST Code Diagnostic LED Decoder .....</b>	<b>133</b>
	<b>Appendix D: POST Code Errors.....</b>	<b>138</b>
	<b>Appendix E: Supported Intel® Server Chassis.....</b>	<b>144</b>
	<b>Glossary .....</b>	<b>146</b>
	<b>Reference Documents .....</b>	<b>149</b>

## List of Figures

Figure 1. Intel® Server Board S2400SC Layout.....	4
Figure 2. Intel® Server Board S2400SC Layout.....	5
Figure 3. Intel® Server Board S2400SC – Mounting Hole Locations (1 of 2).....	7
Figure 4. Intel® Server Board S2400SC – Mounting Hole Locations (2 of 2).....	8
Figure 5. Intel® Server Boards S2400SC – Major Connector Pin-1 Locations (1 of 2) .....	9
Figure 6. Intel® Server Boards S2400SC – Major Connector Pin-1 Locations (2 of 2) .....	10
Figure 7. Intel® Server Boards S2400SC – Primary Side Keepout Zone .....	11
Figure 8. Intel® Server Boards S2400SC – Primary Side Card Side Keepout Zone.....	12
Figure 9. Intel® Server Boards S2400SC – Primary Side Air Duct Keepout Zone.....	13
Figure 10. Intel® Server Boards S2400SC – Second Side Keepout Zone.....	14
Figure 11. Intel® Server Boards S2400SC Rear I/O Layout.....	15
Figure 12. Intel® Server Board S2400SC Functional Block Diagram .....	16
Figure 13. Processor Socket Assembly.....	17
Figure 14. Intel® Server Board S2400SC DIMM Slot Layout.....	25
Figure 15. Functional Block Diagram of Processor IIO Sub-system .....	32
Figure 16. Functional Block Diagram – Chipset Supported Features and Functions .....	33
Figure 17. Integrated Baseboard Management Controller (BMC) Overview .....	41
Figure 18. Integrated BMC Hardware.....	42
Figure 19. Setup Utility – TPM Configuration Screen .....	49
Figure 20. Fan Speed Control Process .....	67
Figure 21. Intel® RMM4 Lite Activation Key Installation .....	83
Figure 22. Intel® RMM4 Dedicated Management NIC Installation.....	84
Figure 23. 5 V Stand-by Status LED Location .....	102
Figure 24. Fan Fault LED Locations.....	103
Figure 25. CPU Fault LED Locations .....	104
Figure 26. System Status LED Location.....	105
Figure 27. DIMM Fault LEDs Location .....	108
Figure 28. POST Code Diagnostic LED Locations .....	110
Figure 29. Power Distribution Block Diagram .....	113
Figure 30. Processor Heatsink Installation .....	145

## List of Tables

Table 1. Intel® Server Board S2400SC Feature Set .....	2
Table 2. Intel® Server Board S2400SC Component Layout.....	5
Table 3. Mixed Processor Configurations.....	18
Table 4. UDIMM Support Guidelines.....	23
Table 5. RDIMM Support Guidelines.....	24
Table 6. Intel® Server Board S2400SC DIMM Nomenclature .....	25
Table 7. External RJ45 NIC Port LED Definition.....	33
Table 8. Intel® RAID C600 Upgrade Key Options.....	39
Table 9. Video Modes .....	43
Table 10. Video mode.....	44
Table 11. TPM Setup Utility – Security Configuration Screen Fields .....	50
Table 12. Intel® Intelligent Power Node Manager .....	53
Table 13. Basic and Advanced Features.....	58
Table 14. ACPI Power States.....	60
Table 15. Power Control Initiators .....	60
Table 16. Fan Profiles .....	65
Table 17. Messaging Interfaces .....	68
Table 18. Factory Configured PEF Table Entries .....	76
Table 19. Diagnostic Data.....	81
Table 20. Additional Diagnostics on Error .....	82
Table 21. RMM4 Option Kits .....	83
Table 22. Board Connector Matrix.....	88
Table 23. Main Power Connector Pin-out (J1H3) .....	89
Table 24. CPU 1/CPU 2 Power Connector Pin-out (J5J2, J8A1).....	89
Table 25. Power Supply Auxiliary Signal Connector Pin-out (J1J2).....	89
Table 26. Intel® RMM4 Connector Pin-out (J1C7) .....	90
Table 27. Intel® RMM4 – Lite Connector Pin-out (J3D1).....	90
Table 28. TPM connector Pin-out (J4J1).....	90
Table 29. LCP Header Pin-out (J3J4) .....	91
Table 30. HSBP_I2C Header Pin-out (J3J1) .....	91
Table 31. SATA SGPIO Header Pin-out(J2J4).....	91
Table 32. Front Panel SSI Standard 24-pin Connector Pin-out (J1C3).....	92
Table 33. VGA Connector Pin-out (J7A2).....	92
Table 34. SATA Connector Pin-out (J1G1, J1F1, J2H1, J1H2, J1H1, J1G2).....	93
Table 35. miniSAS Connector Pin-out (J1D3, J1E1) .....	93
Table 36. miniSAS Connector Pin-out (J1D3, J1E1) .....	93
Table 37. External DB9 Serial A Port Pin-out (J8A2).....	94
Table 38. Internal 9-pin Serial B Header Pin-out (J1B1).....	94



Table 39. External USB Connector Pin-out (U6A1, U7A1) .....	94
Table 40. Internal USB Connector Pin-out (J1C2).....	95
Table 41. Pin-out of Internal Low-Profile USB Connector for Solid State Drive (J2E1) .....	95
Table 42. Internal Type A USB Port Pin-out (J1J1) .....	95
Table 43. SSI 4-pin Fan Header Pin-out (J5J1, J7A1, J9A1).....	96
Table 44. SSI 6-pin Fan Header Pin-out (J2J5, J2J6, J2J7, J2J8, J3J2 and J3J3).....	96
Table 45. Server Board Jumpers (J1C4, J1C5, J1C6, J2J2, J2J3, J2J4) .....	97
Table 46. System Status LED .....	106
Table 47. BMC Boot/Reset Status LED Indicators .....	109
Table 48. Server Board Design Specifications .....	111
Table 49. Integrated BMC Core Sensors.....	117
Table 50. POST Progress Code LED Example .....	134
Table 51. POST Progress Codes.....	134
Table 52. MRC Progress Codes .....	136
Table 53. POST Progress LED Codes .....	137
Table 54. POST Error Codes and Messages .....	139
Table 55. POST Error Beep Codes.....	142
Table 56. Integrated BMC Beep Codes.....	143
Table 57. Intel® Server Chassis P4000S for S2400 family.....	144
Table 58. Intel® Server Chassis P4000M family: .....	144

**<This page is intentionally left blank.>**

# 1. Introduction

---

This Technical Product Specification (TPS) provides board specific information detailing the features, functionality, and high-level architecture of the Intel® Server Board S2400SC.

In addition, you can obtain design-level information for specific subsystems by ordering the External Product Specifications (EPS) or External Design Specifications (EDS) for a given subsystem. EPS and EDS documents are not publicly available and you must order them through your Intel representative.

## 1.1 Chapter Outline

This document is divided into the following chapters:

- Chapter 1 – Introduction
- Chapter 2 – Overview
- Chapter 3 – Functional Architecture
- Chapter 4 – System Security
- Chapter 5 – Technology Support
- Chapter 6 – Platform Management Functional Overview
- Chapter 7 – Advanced Management Feature Support (RMM4)
- Chapter 8 – On-board Connector/Header Overview
- Chapter 9 – Jumper Blocks
- Chapter 10 – Intel® Light Guided Diagnostics
- Chapter 11 – Environmental Limits Specifications
- Appendix A – Integration and Usage Tips
- Appendix B – Integrated BMC Sensor Tables
- Appendix C – POST Code Diagnostic LED Decoder
- Appendix D – POST Code Errors
- Appendix E – Supported Intel® Server Chassis
- Glossary
- Reference Documents

## 1.2 Server Board Use Disclaimer

Intel® Server Boards contain a number of high-density VLSI (Very-large-scale integration) and power delivery components that require adequate airflow for cooling. Intel ensures through its own chassis development and testing that when Intel® server building blocks are used together, the fully integrated system meets the intended thermal requirements of these components. It is the responsibility of the system integrator who chooses not to use Intel developed server building blocks to consult vendor datasheets and operating parameters to determine the amount of airflow required for their specific application and environmental conditions. Intel Corporation cannot be held responsible if components fail or the server board does not operate correctly when used outside any of the published operating or non-operating limits.

## 2. Overview

The Intel® Server Board S2400SC is monolithic printed circuit boards (PCBs) with features designed to support the pedestal and rack server markets.

### 2.1 Intel® Server Boards S2400SC Feature Set

**Table 1. Intel® Server Board S2400SC Feature Set**

Feature	Description
Processors	<ul style="list-style-type: none"> <li>▪ Support for one or two Intel® Xeon® processor E5-2400 processor(s) in an FC-LGA 1356 Socket B2 package with Thermal Design Power up to 95W.</li> <li>▪ 6.4 GT/s, 7.2 GT/s and 8.0 GT/s Intel® QuickPath Interconnect (Intel® QPI).</li> <li>▪ EVRD (Enterprise Voltage Regulator-Down) 12</li> </ul>
Memory	<ul style="list-style-type: none"> <li>▪ Six memory channels, eight memory DIMMs (three channels per processor socket; 2:1:1 layout).</li> <li>▪ Support for 1066/1333 MT/s Unbuffered (UDIMM) LVDDR3 or DDR3 memory.</li> <li>▪ Support for 800/1066/1333/1600 MT/s ECC Registered (RDIMM) DDR3 memory.</li> <li>▪ Support for 800/1066/1333 ECC Registered (RDIMM) LVDDR3 memory.</li> <li>▪ No support for mixing of RDIMMs and UDIMMs.</li> <li>▪ No support for LRDIMMs.</li> <li>▪ No support for Quad Rank DIMMs.</li> </ul>
Chipset	Intel® C602 (-A) chipset with support for storage option upgrade keys
Cooling Fan Support	<p>Support for:</p> <ul style="list-style-type: none"> <li>▪ Two processor fans (4-pin headers).</li> <li>▪ Six front system fans (6-pin headers).</li> <li>▪ One rear system fan (4-pin headers)</li> <li>▪ 3-pin fans are compatible with all fan headers.</li> </ul>
Add-in Card Slots	<p>Five expansion slots:</p> <ul style="list-style-type: none"> <li>▪ Slot 6: PCI Express* Gen3 x16 electrical with x16 physical connector, from first processor.</li> <li>▪ Slot 5 PCI Express* Gen3 x8 electrical with x8 open ended physical connector, from second processor.</li> <li>▪ Slot 4: PCI Express* Gen3 x4 electrical with x8 physical connector, from first processor.</li> <li>▪ Slot 3: PCI Express* Gen2 x4 electrical with x8 physical connector, from PCH.</li> <li>▪ Slot 2: 32-bit/33 MHz PCI slot, from PCH</li> </ul>
Hard Drive and Optical Drive Support	<ul style="list-style-type: none"> <li>▪ Optical devices are supported.</li> <li>▪ Two SATA connectors at 6Gbps and four SATA connectors at 3Gbps.</li> <li>▪ Up to eight SAS connectors at 3Gbps with optional Intel® C600 RAID Upgrade Keys.</li> </ul>
RAID Support	<ul style="list-style-type: none"> <li>▪ Intel® RSTe SW RAID 0/1/10/5</li> <li>▪ LSI* SW RAID 0/1/10/5</li> </ul>
I/O control support	<p>External connections:</p> <ul style="list-style-type: none"> <li>▪ DB9 serial port A connection.</li> <li>▪ Two RJ-45 NIC connectors for 10/100/1000 Mb connections: Dual GbE through the Intel® 82574L Network Connection.</li> <li>▪ Four USB 2.0 ports at the back of the board.</li> <li>▪ One DB-15 video connector</li> </ul>

Feature	Description
	Internal connections: <ul style="list-style-type: none"> <li>▪ One 2x5 pin USB header, providing front panel support for two USB ports.</li> <li>▪ One DH10 serial port B header.</li> <li>▪ One internal Type-A USB 2.0 port.</li> <li>▪ One 9pin USB header for eUSB SSD.</li> <li>▪ One 1x7 pin header for optional Intel® Local Control Panel support</li> <li>▪ One SSI-compliant 24-pin front control panel header.</li> </ul>
Video Support	<ul style="list-style-type: none"> <li>▪ Integrated 2D video controller.</li> <li>▪ Dual monitor video mode is supported.</li> <li>▪ 16 MB DDR3 Memory</li> </ul>
LAN	Two Gigabit Ethernet Ports through Intel® 82574L PHYs
Security	Trusted Platform Module (Optional)
Server Management	<ul style="list-style-type: none"> <li>▪ Onboard ServerEngines* LLC Pilot III* Controller.</li> <li>▪ Support for Intel® Remote Management Module 4 solutions (Optional).</li> <li>▪ Support for Intel® Remote Management Module 4 Lite solutions (Optional).</li> <li>▪ Intel® Light-Guided Diagnostics on field replaceable units.</li> <li>▪ Support for Intel® System Management Software.</li> <li>▪ Support for Intel® Intelligent Power Node Manager (Need PMBus*-compliant power supply).</li> </ul>
BIOS Flash	Winbond* 64MB Flash
Form Factor	SSI CEB 12"x10.5 compliant form factor.
Compatible Intel® Server Chassis	<ul style="list-style-type: none"> <li>▪ Intel® Server Chassis P4000S for S2400SC.</li> <li>▪ Intel® Server Chassis P4000M Chassis</li> </ul>

## 2.2 Server Board Layout

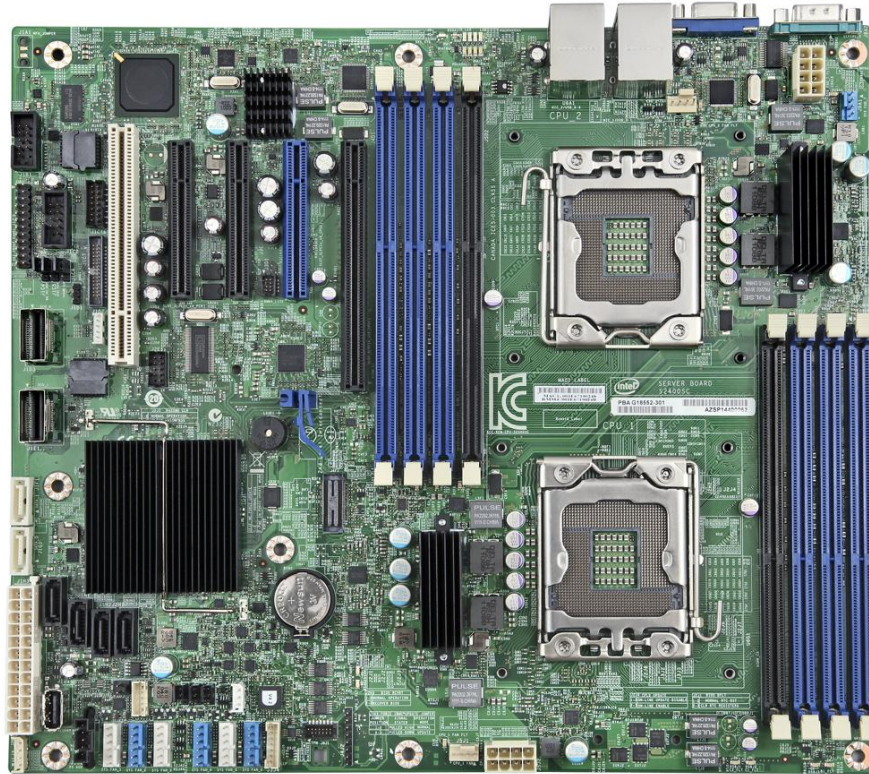
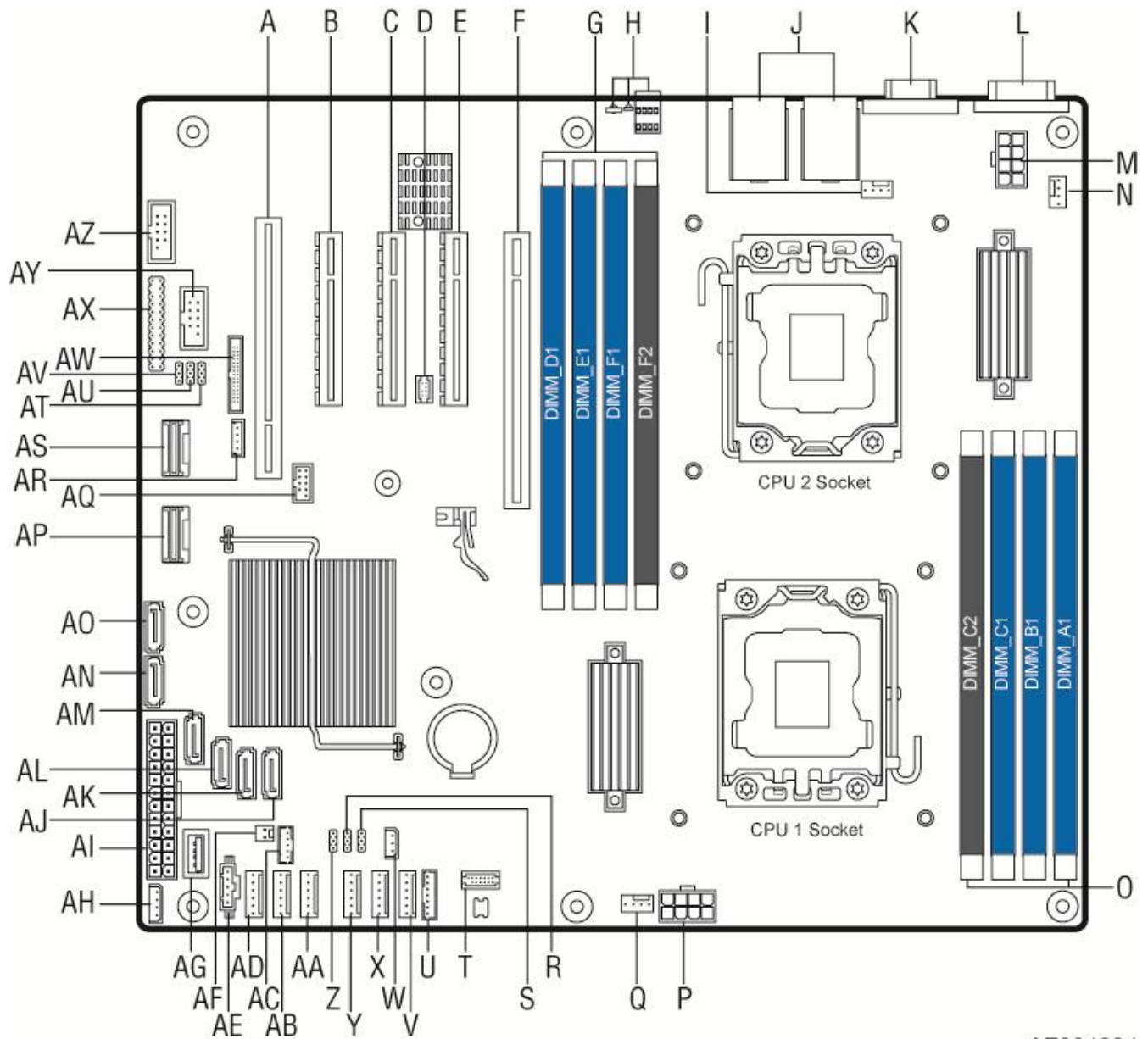

Figure 1. Intel® Server Board S2400SC Layout

### 2.2.1 Server Board Connector and Component Layout

The following figure shows the layout of the server board. Each connector and major component is identified by a number or letter, and a description is given in the below figure.



AF004234

**Figure 2. Intel® Server Board S2400SC Layout**

**Table 2. Intel® Server Board S2400SC Component Layout**

Description		Description	
A	Slot 2, 32bit/33MHz PCI	AA	System fan 3 header
B	Slot 3, PCI Express* Gen2 x4 (x8 connector)	AB	System fan 2 header
C	Slot 4, PCI Express* Gen3 x8	AC	SATA SGPIO header
D	RMM4 Lite header	AD	System fan 1 header
E	Slot 5, PCI Express* Gen3 x8 (open ended connector, from second	AE	PMBus* header

	Description		Description
	processor)		
F	Slot 6, PCI Express* Gen3 x16, support riser card	AF	HDD LED header
G	DIMM sockets from Processor 2 socket (Channel D, E, F)	AG	Type A USB header
H	Diagnostic and identify LEDs	AH	IPMB header
I	Processor 2 Fan header	AI	Main Power
J	RJ45/USB stack connectors	AJ	SATA port 2
K	VGA	AK	SATA port 3
L	Serial Port A	AL	SATA port 4
M	Processor 2 power	AM	SATA port 5
N	System fan 7 header	AN	SATA port 0
O	DIMM sockets from Processor 1 socket (Channel A, B, C)	AO	SATA port 1
P	Processor 1 power	AP	SCU 1
Q	Processor 1 Fan header	AQ	eUSB SSD header
R	BIOS default jumper	AR	Storage upgrade key
S	CPLD update jumper (not used)	AS	SCU 0
T	TPM header	AT	Password clear jumper
U	LCP header	AU	BIOS recovery jumper
V	System fan 6 header	AV	BMC force update jumper
W	HSBP I2C header	AW	RMM4 header
X	System fan 5 header	AX	Front panel header
Y	System fan 4 header	AY	USB header
Z	ME Force Update jumper	AZ	Serial B header



## 2.2.2 Server Board Mechanical Drawings

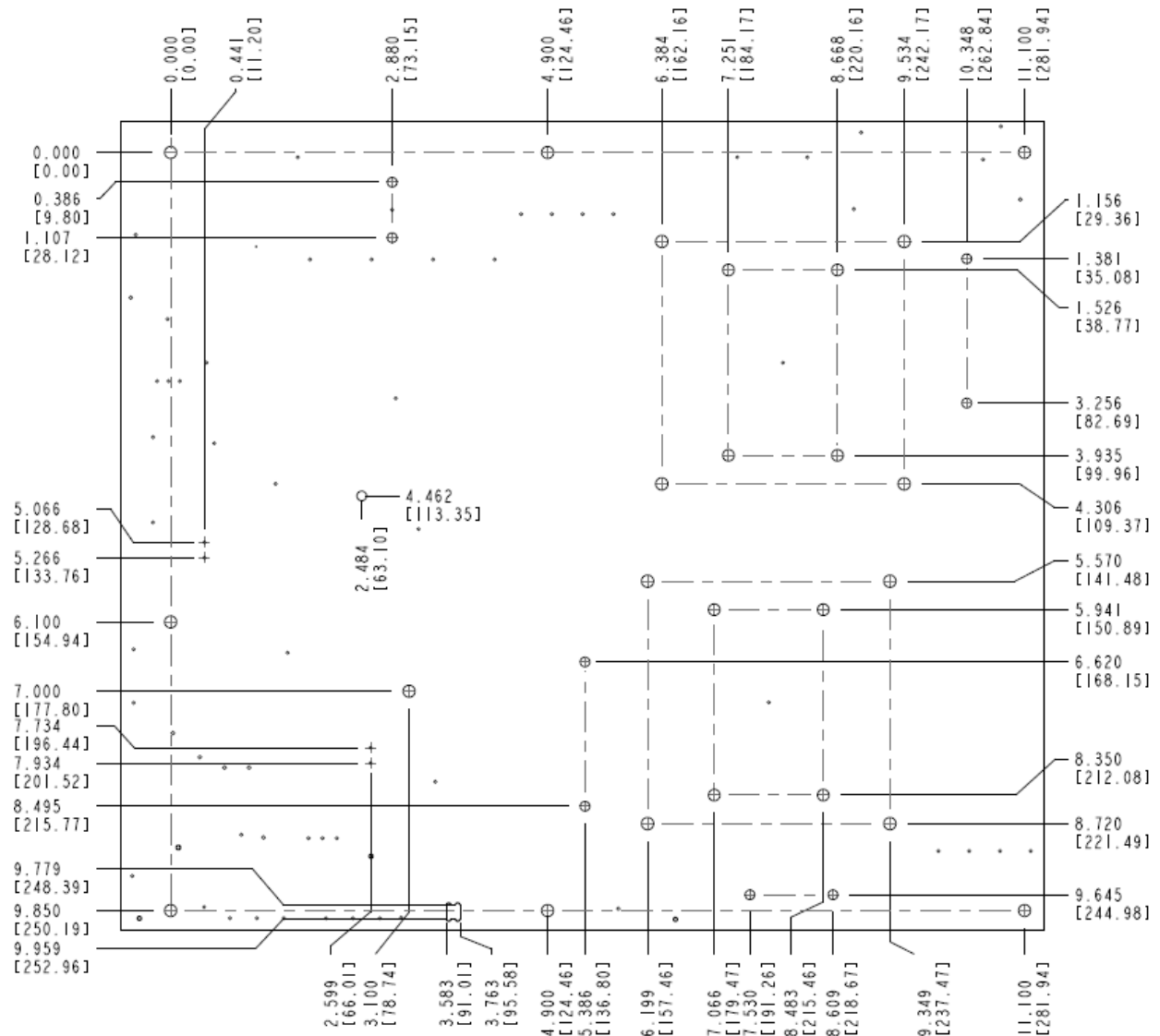

Figure 3. Intel® Server Board S2400SC – Mounting Hole Locations (1 of 2)

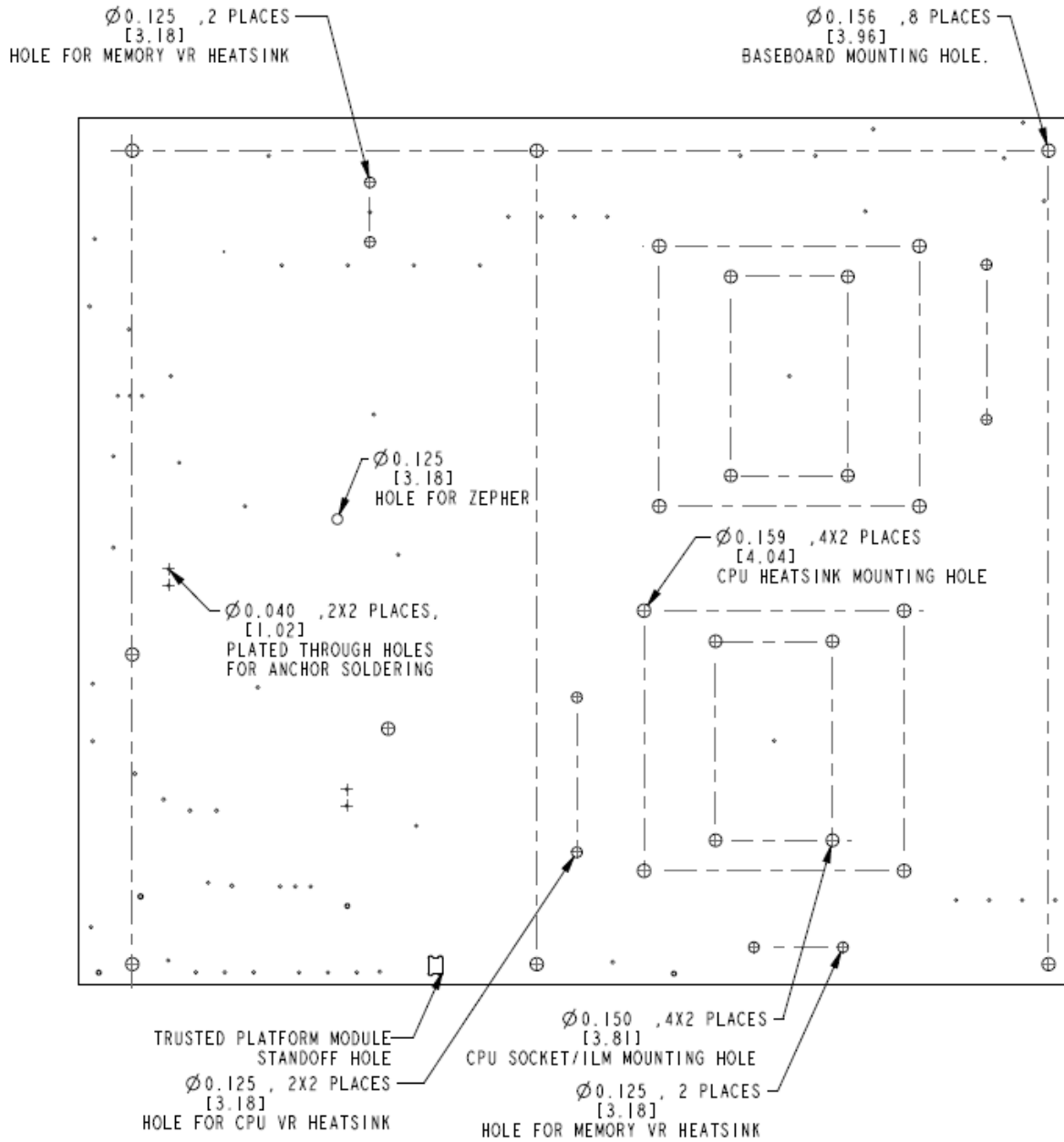

Figure 4. Intel® Server Board S2400SC – Mounting Hole Locations (2 of 2)

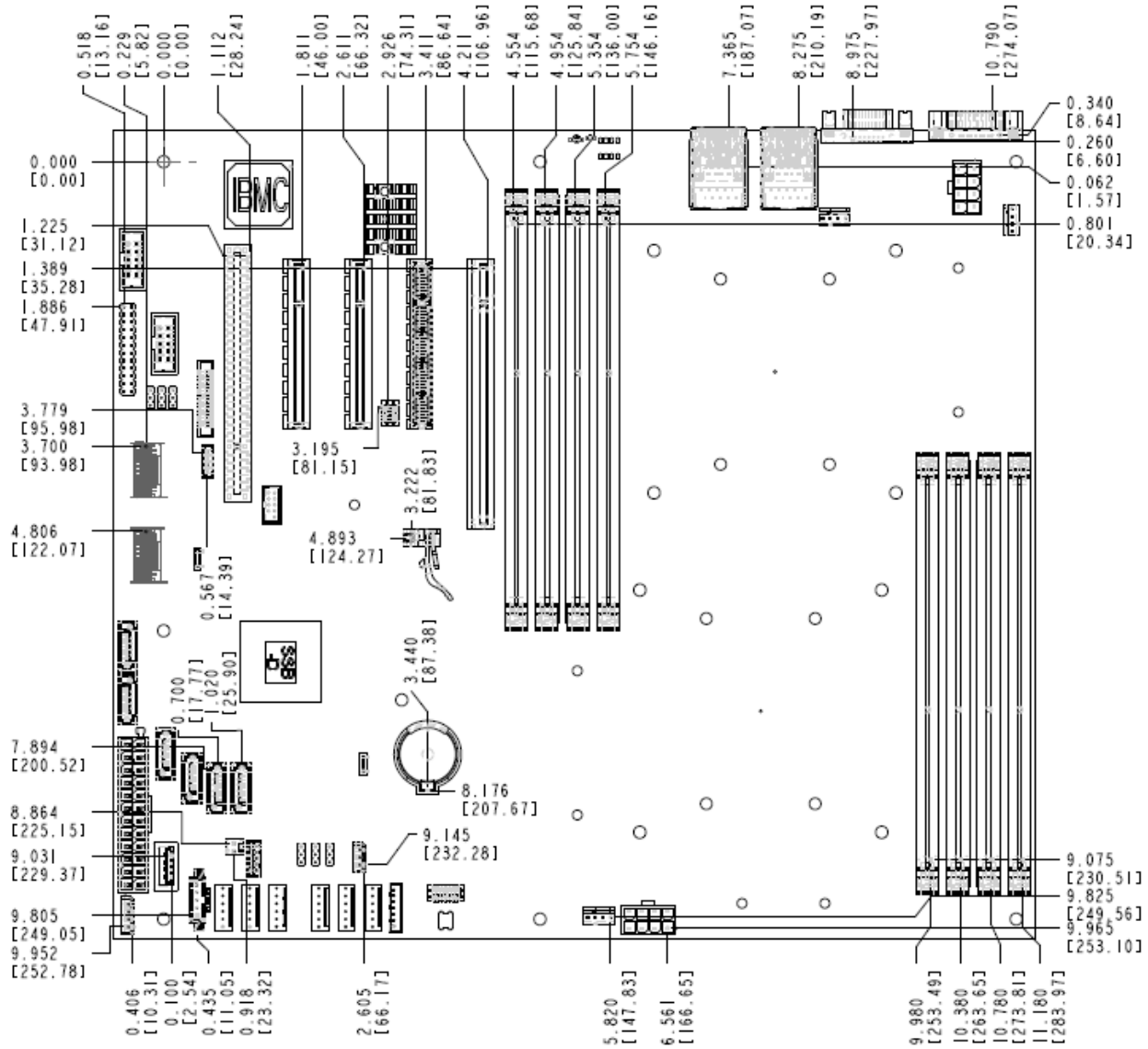

Figure 5. Intel® Server Boards S2400SC – Major Connector Pin-1 Locations (1 of 2)

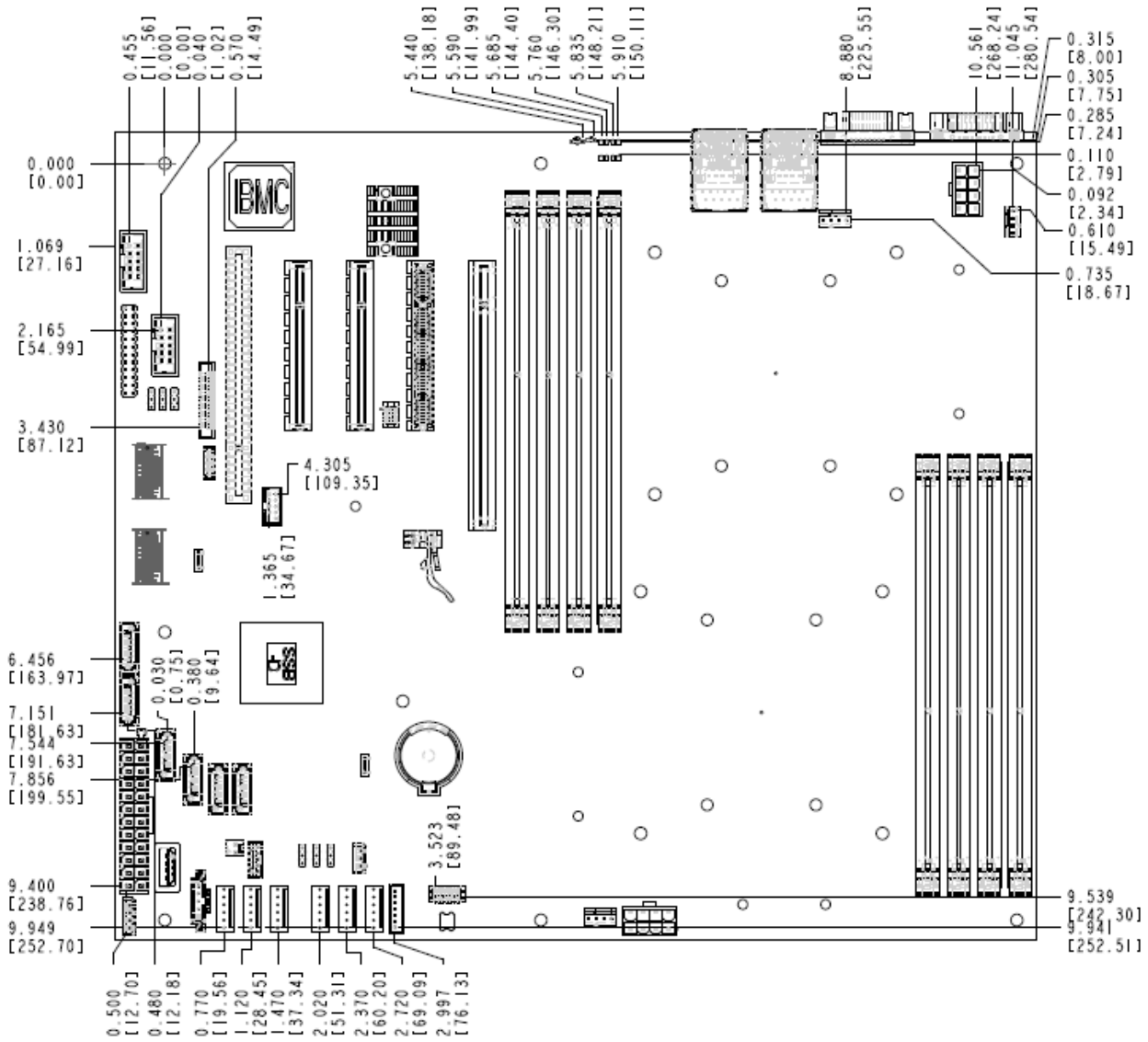

Figure 6. Intel® Server Boards S2400SC – Major Connector Pin-1 Locations (2 of 2)

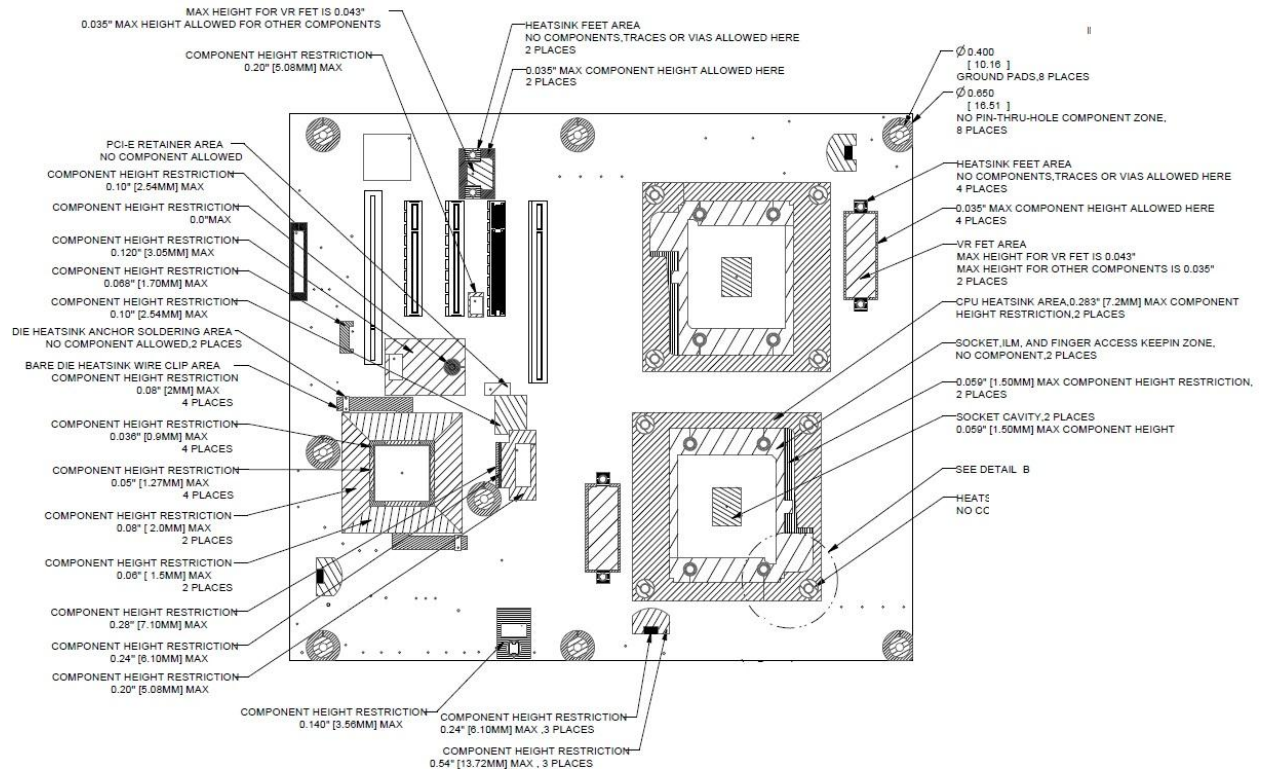

Figure 7. Intel® Server Boards S2400SC – Primary Side Keepout Zone

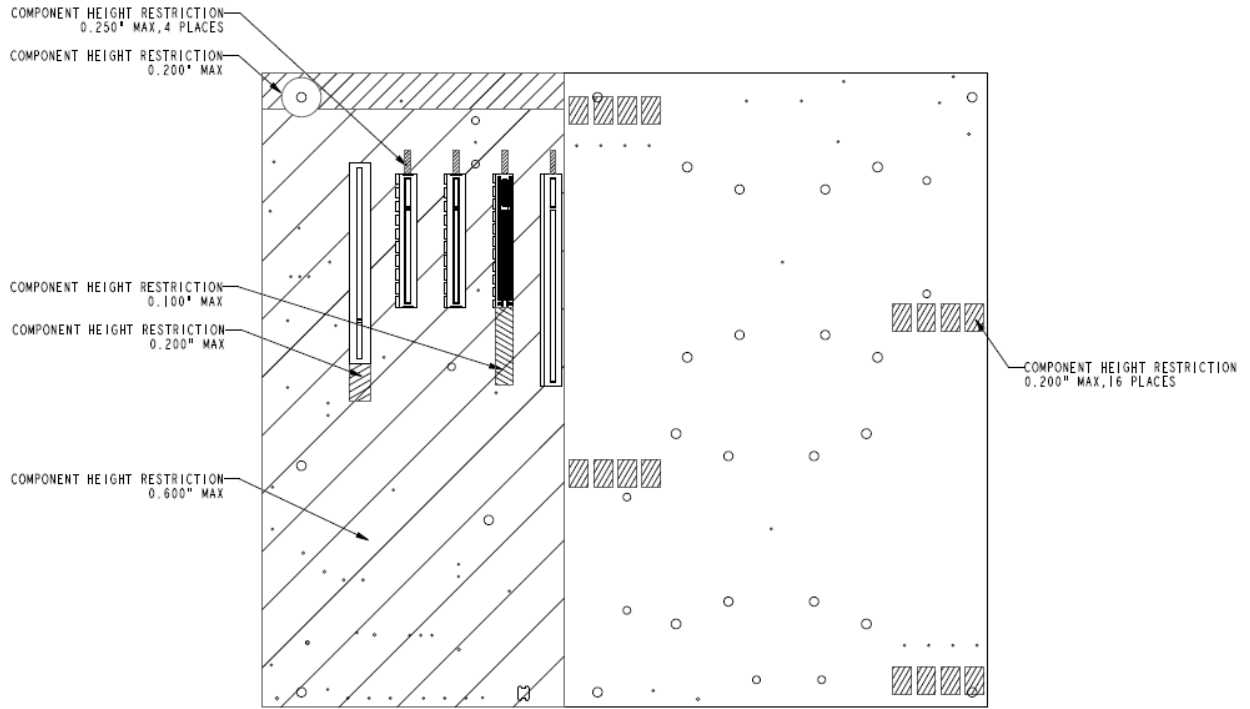
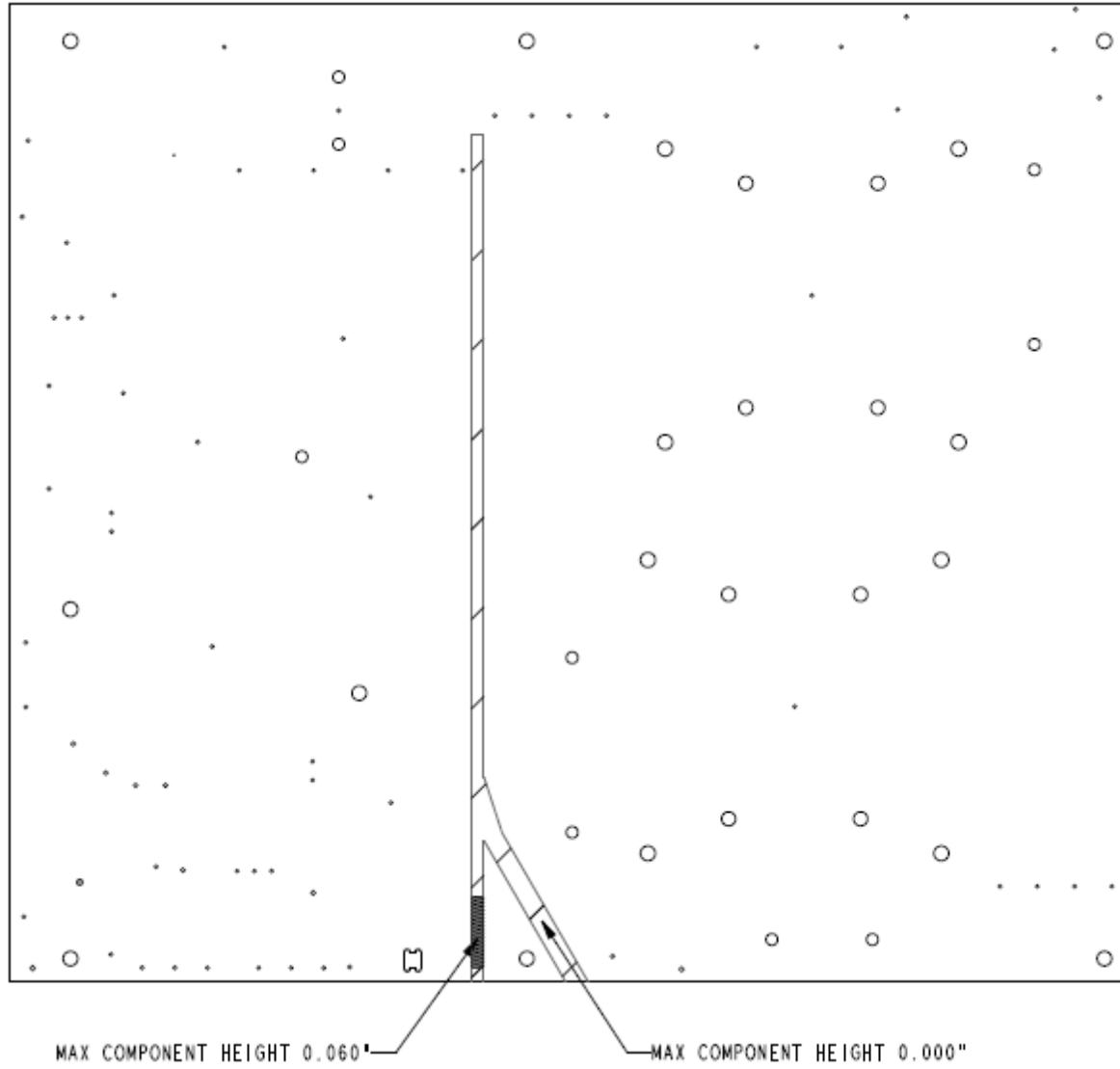

Figure 8. Intel® Server Boards S2400SC – Primary Side Card Side Keepout Zone



**Figure 9. Intel® Server Boards S2400SC – Primary Side Air Duct Keepout Zone**

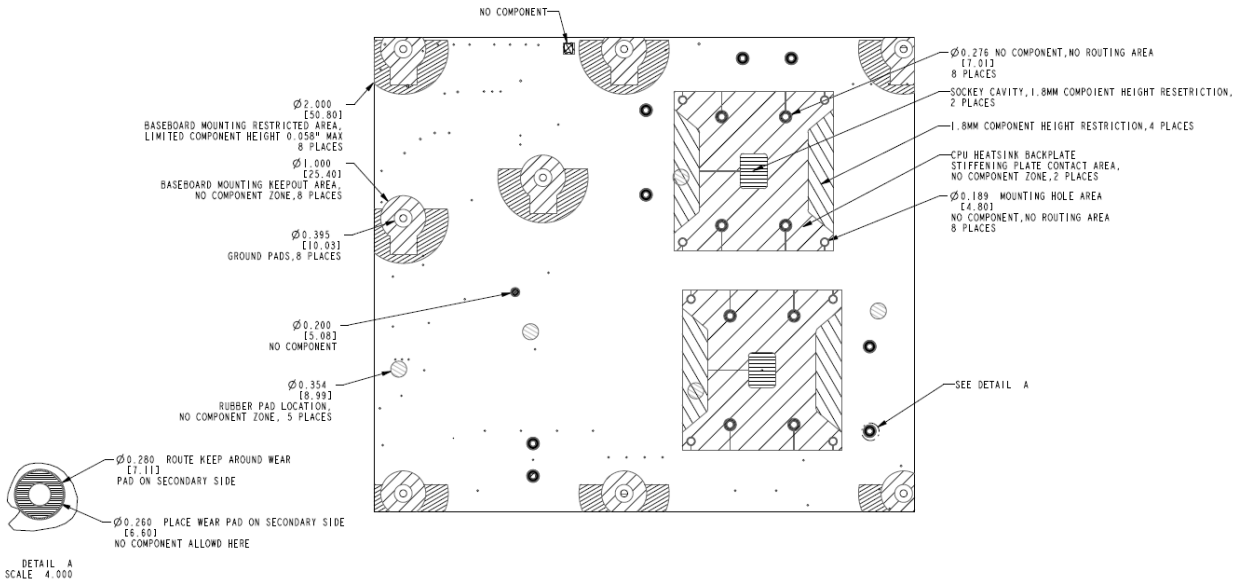
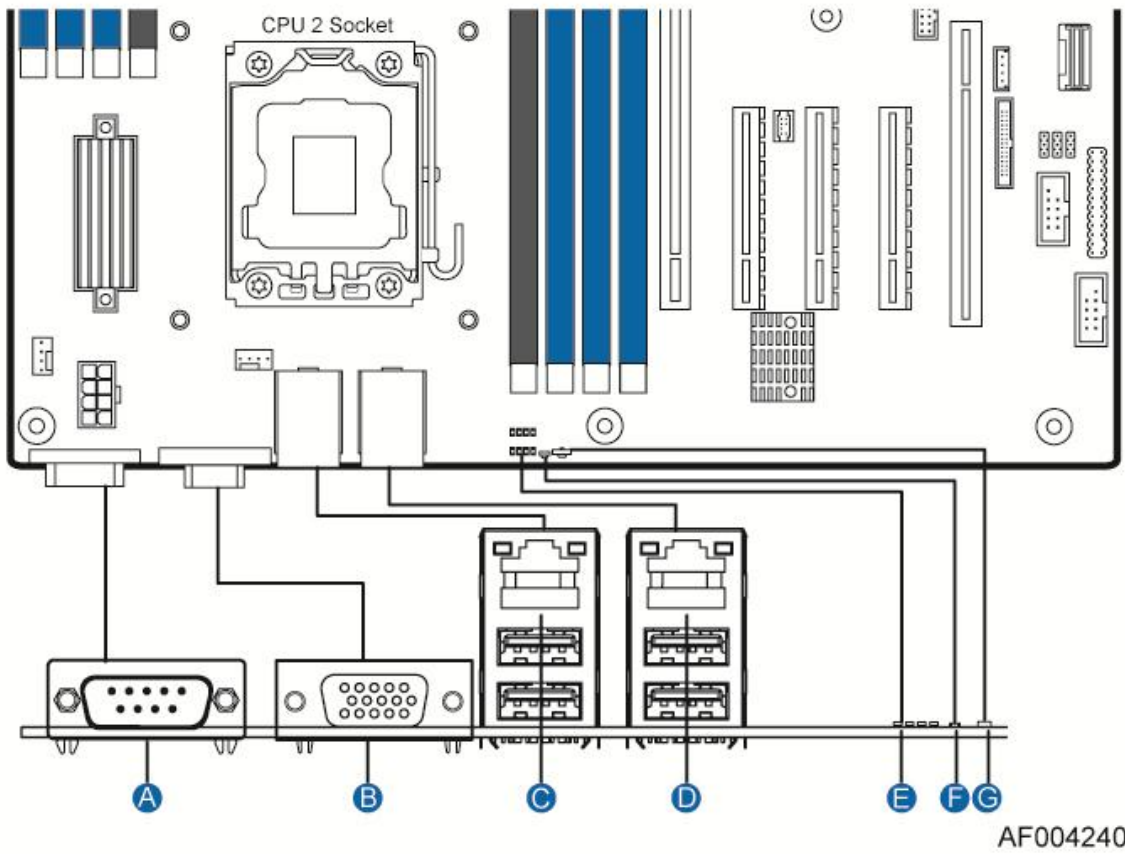

Figure 10. Intel® Server Boards S2400SC – Second Side Keepout Zone

### 2.2.3 Server Board Rear I/O Layout

The following drawing shows the layout of the rear I/O components for the server boards.





A	Serial Port A	E	Diagnostic LEDs
B	Video	F	ID LED
C	NIC Port 1 (1 Gb)_USB_0-1	G	System Status LED
D	NIC Port 2 (1 Gb)_USB_2-3		

**Figure 11. Intel® Server Boards S2400SC Rear I/O Layout**

### 3. Functional Architecture

The architecture and design of the Intel® Server Board S2400SC is based on the Intel® C600 chipset. The chipset is designed for systems based on the Intel® Xeon® processor in an FC-LGA 1356 Socket B2 package with Intel® QuickPath Interconnect (Intel® QPI).

This chapter provides a high-level description of the functionality associated with each chipset component and the architectural blocks that make up the server boards.

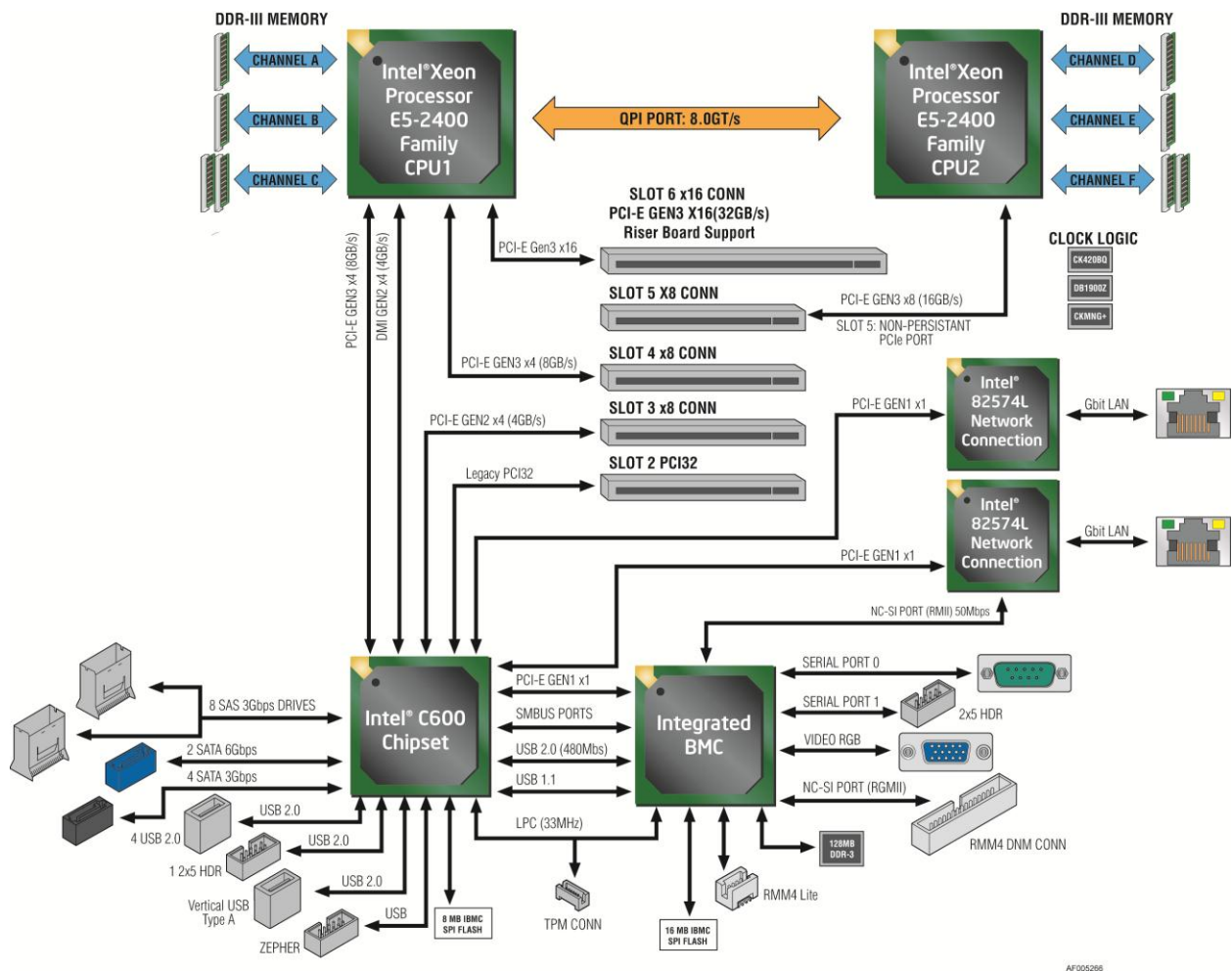

Figure 12. Intel® Server Board S2400SC Functional Block Diagram

#### 3.1 Processor Support

The Intel® Server Board S2400SC includes two Socket-B2 (LGA-1356) processor sockets and can support the following processor: Intel® Xeon® processor E5-2400 product family, with a Thermal Design Power (TDP) of up to 95W.

**Note:** Previous generation Intel® Xeon® processors are not supported on the Intel® server board described in this document.

Visit the Intel web site for a complete list of supported processors.

### 3.1.1 Processor Socket Assembly

Each processor socket of the server board is pre-assembled with an Independent Latching Mechanism (ILM) and Back Plate which allow for secure placement of the processor and processor heat to the server board.

The illustration below identifies each sub-assembly component.

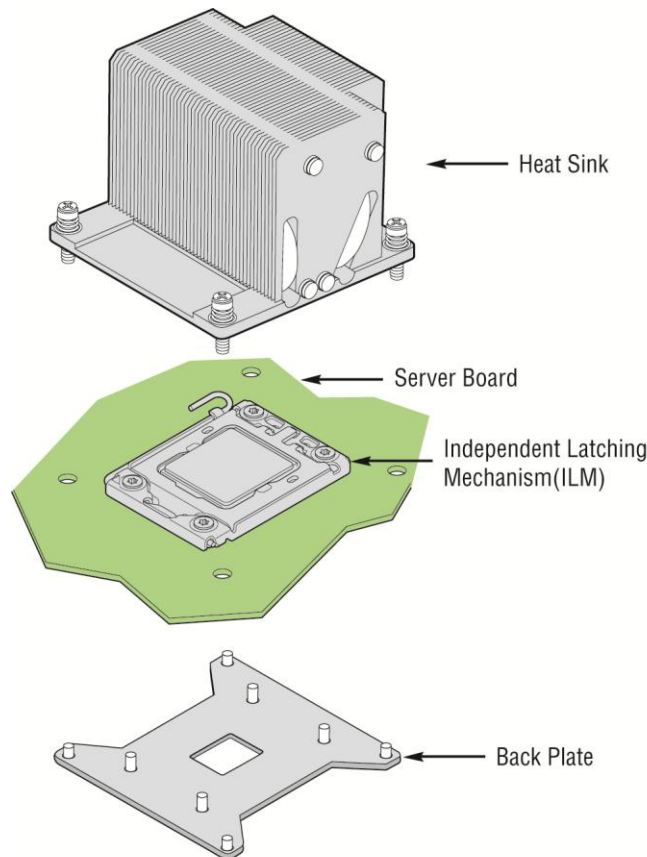

AF004320

**Figure 13. Processor Socket Assembly**

### 3.1.2 Processor Population rules

**Note:** Although the server board does support dual-processor configurations consisting of different processors that meet the defined criteria below, Intel does not perform validation testing of this configuration. For optimal system performance in dual-processor configurations, Intel recommends that identical processors be installed.

When using a single processor configuration, the processor must be installed into the processor socket labeled "CPU\_1".

When two processors are installed, the following population rules apply:

- Both processors must be of the same processor family.

- Both processors must have the same number of cores.
- Both processors must have the same cache size for all levels of processor cache memory.
- Processors with different speeds can be mixed in a system, given the prior rules are met. If this condition is detected, all processor speeds are set to the lowest common denominator (highest common speed) and an error is reported.
- Processors which have different Intel Quickpath (QPI) Link Frequencies may operate together if they are otherwise compatible and if a common link frequency can be selected. The common link frequency would be the highest link frequency that all installed processors can achieve.
- Processor stepping within a common processor family can be mixed as long as it is listed in the processor specification updates published by Intel Corporation.

The following table describes mixed processor conditions and recommended actions for all Intel® server boards and Intel server systems designed around the Intel® Xeon® processor E5-2400 product family and Intel® C600 chipset product family architecture. The errors fall into one of the following two categories:

- **Fatal:** If the system can boot, it pauses at a blank screen with the text “**Unrecoverable fatal error found. System will not boot until the error is resolved**” and “**Press <F2> to enter setup**” regardless of whether the “Post Error Pause” setup option is enabled or disabled.
- **Major:** If the “POST Error Pause” option in BIOS Setup is disabled, the system will log the error to the BIOS Setup Utility Error Manager and then continue to boot. No POST error message is given. If the “POST Error Pause” option in BIOS Setup is enabled, the error is logged and the system goes directly to the Error Manager in BIOS Setup.
- **Minor:** The message is displayed on the screen or on the Error manager screen, and the POST Error code is logged to SEL. The system continues booting in a degraded state. The user may want to replace the erroneous unit. The POST Error Pause option setting in the BIOS does not have any effect on this error.

**Table 3. Mixed Processor Configurations**

Error	Severity	System Action
Processor family not Identical	Fatal	The BIOS detects the error condition and responds as follows: Logs the POST Error Code into the System Event Log (SEL). Alerts the BMC to set the System Status LED to steady Amber. Displays “0194: Processor family mismatch detected” message in the Error Manager. Takes Fatal Error action (see above) and will not boot until the fault condition is remedied.
Processor model not Identical	Fatal	The BIOS detects the error condition and responds as follows: Logs the POST Error Code into the System Event Log (SEL). Alerts the BMC to set the System Status LED to steady Amber. Displays “0196: Processor model mismatch detected” message in the Error Manager. Takes Fatal Error action (see above) and will not boot until the fault condition is remedied.

Error	Severity	System Action
Processor cores/threads not identical	Fatal	<p>The BIOS detects the error condition and responds as follows:</p> <ul style="list-style-type: none"> <li>Logs the POST Error Code into the SEL.</li> <li>Alerts the BMC to set the System Status LED to steady Amber.</li> <li>Displays “0191: Processor core/thread count mismatch detected” message in the Error Manager.</li> <li>Takes Fatal Error action (see above) and will not boot until the fault condition is remedied.</li> </ul>
Processor cache not identical	Fatal	<p>The BIOS detects the error condition and responds as follows:</p> <ul style="list-style-type: none"> <li>Logs the POST Error Code into the SEL.</li> <li>Alerts the BMC to set the System Status LED to steady Amber.</li> <li>Displays “0192: Processor cache size mismatch detected message in the Error Manager.</li> <li>Takes Fatal Error action (see above) and will not boot until the fault condition is remedied.</li> </ul>
Processor frequency (speed) not identical	Fatal	<p>The BIOS detects the processor frequency difference, and responds as follows:</p> <ul style="list-style-type: none"> <li>Adjusts all processor frequencies to the highest common frequency.</li> <li>No error is generated – this is not an error condition.</li> <li>Continues to boot the system successfully.</li> <li>If the frequencies for all processors cannot be adjusted to be the same, then this is an error, and the BIOS responds as follows:</li> <li>Logs the POST Error Code into the SEL.</li> <li>Alerts the BMC to set the System Status LED to steady Amber.</li> <li>Does not disable the processor.</li> <li>Displays “0197: Processor speeds unable to synchronize” message in the Error Manager.</li> <li>Takes Fatal Error action (see above) and will not boot until the fault condition is remedied.</li> </ul>
Processor Intel® QuickPath Interconnect link frequencies not identical	Fatal	<p>The BIOS detects the QPI link frequencies and responds as follows:</p> <ul style="list-style-type: none"> <li>Adjusts all QPI interconnect link frequencies to highest common frequency.</li> <li>No error is generated – this is not an error condition.</li> <li>Continues to boot the system successfully.</li> <li>If the link frequencies for all QPI links cannot be adjusted to be the same, then this is an error, and the BIOS responds as follows:</li> <li>Logs the POST Error Code into the SEL.</li> <li>Alerts the BMC to set the System Status LED to steady Amber.</li> <li>Displays “0195: Processor Intel® QPI link frequencies unable to synchronize” message in the Error Manager.</li> <li>Does not disable the processor.</li> <li>Takes Fatal Error action (see above) and will not boot until the fault condition is remedied.</li> </ul>
Processor microcode update missing	Minor	<p>The BIOS detects the error condition and responds as follows:</p> <ul style="list-style-type: none"> <li>Logs the POST Error Code into the SEL.</li> <li>Displays “818x: Processor 0x microcode update not found” message in the Error Manager or on the screen.</li> <li>The system continues to boot in a degraded state, regardless of the setting of POST Error Pause in the Setup.</li> </ul>

Error	Severity	System Action
Processor microcode update failed	Major	<p>The BIOS detects the error condition and responds as follows:</p> <p>Logs the POST Error Code into the SEL.</p> <p>Displays “816x: Processor 0x unable to apply microcode update” message in the Error Manager or on the screen.</p> <p>Takes Major Error action. The system may continue to boot in a degraded state, depending on the setting of POST Error Pause in Setup, or may halt with the POST Error Code in the Error Manager waiting for operator intervention.</p>

## 3.2 Processor Function Overview

With the release of the Intel® Xeon® processor E5-2400 product family, several key system components, including the CPU, Integrated Memory Controller (IMC), and Integrated IO Module (IIO), have been combined into a single processor package and feature per socket; One Intel® QuickPath Interconnect point-to-point links capable of up to 8.0 GT/s, up to 24 lanes of Gen 3 PCI Express\* links capable of 8.0 GT/s, and 4 lanes of DMI2/PCI Express\* Gen 1 interface with a peak transfer rate of 2.5 GT/s. The processor supports up to 46 bits of physical address space and 48-bit of virtual address space.

The following sections will provide an overview of the key processor features and functions that help to define the performance and architecture of the server board. For more comprehensive processor specific information, refer to the Intel® Xeon® processor E5-2400 product family documents listed in the Reference Document list.

### Processor Feature Details:

- Up to eight execution cores
- Each core supports two threads (Intel® Hyper-Threading Technology), up to 16 threads per socket
- 46-bit physical addressing and 48-bit virtual addressing
- 1 GB large page support for server applications
- A 32-KB instruction and 32-KB data first-level cache (L1) for each core
- A 256-KB shared instruction/data mid-level (L2) cache for each core
- Up to 20 MB last level cache (LLC): up to 2.5 MB per core instruction/data last level cache (LLC), shared among all cores

### Supported Technologies:

- Intel® Virtualization Technology (Intel® VT)
- Intel® Virtualization Technology for Directed I/O (Intel® VT-d)
- Intel® Virtualization Technology “Sandy Bridge” Processor Extensions
- Intel® Data Direct I/O Technology
- Intel® Trusted Execution Technology (Intel® TXT)
- Intel® 64 Architecture
- Intel® Streaming SIMD Extensions 4.1 (Intel® SSE4.1)
- Intel® Streaming SIMD Extensions 4.2 (Intel® SSE4.2)
- Intel® Advanced Vector Extensions (Intel® AVX)
- Intel® Hyper-Threading Technology
- Execute Disable Bit
- Intel® Turbo Boost Technology
- Intel® Intelligent Power Technology
- Enhanced Intel® SpeedStep Technology

### 3.2.1 Intel® QuickPath Interconnect

The Intel® QuickPath Interconnect is a high speed, packetized, point-to-point interconnect used in the processor. The narrow high-speed links stitch together processors in distributed shared memory and integrated I/O platform architecture. It offers much higher bandwidth with low latency. The Intel® QuickPath Interconnect has an efficient architecture allowing more interconnect performance to be achieved in real systems. It has a snoop protocol optimized for low latency and high scalability, as well as packet and lane structures enabling quick completions of transactions. Reliability, availability, and serviceability features (RAS) are built into the architecture.

The physical connectivity of each interconnect link is made up of twenty differential signal pairs plus a differential forwarded clock. Each port supports a link pair consisting of two uni-directional links to complete the connection between two components. This supports traffic in both directions simultaneously. To facilitate flexibility and longevity, the interconnect is defined as having five layers: Physical, Link, Routing, Transport, and Protocol.

The Intel® QuickPath Interconnect includes a cache coherency protocol to keep the distributed memory and caching structures coherent during system operation. It supports both low-latency source snooping and a scalable home snoop behavior. The coherency protocol provides for direct cache-to-cache transfers for optimal latency.

### 3.2.2 Integrated Memory Controller (IMC) and Memory Subsystem

Integrated into the processor is a memory controller. Each processor provides three DDR3 channels that support the following:

- Unbuffered DDR3 and registered DDR3 DIMMs
- Independent channel mode or lockstep mode
- Data burst length of eight cycles for all memory organization modes
- Memory DDR3 data transfer rates of 800, 1066, 1333, and 1600 MT/s
- 64-bit wide channels plus 8-bits of ECC support for each channel
- DDR3 standard I/O Voltage of 1.5 V and DDR3 Low Voltage of 1.35 V
- 1-Gb, 2-Gb, and 4-Gb DDR3 DRAM technologies supported for these devices:
  - UDIMM DDR3 – SR x8 and x16 data widths, DR – x8 data width
  - RDIMM DDR3 – SR and DR – x4 and x8 data widths
- Up to 4 ranks supported per memory channel, 1 or 2 ranks per DIMM
- Open with adaptive idle page close timer or closed page policy
- Per channel memory test and initialization engine can initialize DRAM to all logical zeros with valid ECC (with or without data scrambler) or a predefined test pattern
- Isochronous access support for Quality of Service (QoS)
- Minimum memory configuration: independent channel support with 1 DIMM populated
- Integrated dual SMBus\* master controllers
- Command launch modes of 1n/2n
- RAS Support:
  - Rank Level Sparing and Device Tagging
  - Demand and Patrol Scrubbing



- DRAM Single Device Data Correction (SDDC) for any single x4 or x8 DRAM device. Independent channel mode supports x4 SDDC. x8 SDDC requires lockstep mode
- Lockstep mode where channels 0 & 1 and channels 2 & 3 are operated in lockstep mode
- Data scrambling with address to ease detection of write errors to an incorrect address.
- Error reporting from the Machine Check Architecture
- Read Retry during CRC error handling checks by iMC
- Channel mirroring within a socket
  - CPU1 Channel Mirror Pairs B and C
  - CPU2 Channel Mirror Pairs E and F
- Error Containment Recovery
  - Improved Thermal Throttling with dynamic Closed Loop Thermal Throttling (CLTT)
  - Memory thermal monitoring support for DIMM temperature

### 3.2.2.1 Supported Memory

**Table 4. UDIMM Support Guidelines**

Ranks Per DIMM & Data Width	Memory Capacity Per DIMM1			Speed (MT/s) and Voltage Validated by Slot per Channel (SPC) and DIMM Per Channel (DPC)2,3						
				1 Slot per Channel			2 Slots per Channel			
				1DPC			1DPC		2DPC	
				1.35V	1.5V		1.35V	1.5V	1.35V	1.5V
SRx8 Non-ECC	1GB	2GB	4GB	n/a	1066, 1333,	n/a	1066, 1333	n/a	1066	
DRx8 Non-ECC	2GB	4GB	8GB	n/a	1066, 1333,	n/a	1066, 1333	n/a	1066	
SRx16 Non-ECC	512MB	1GB	2GB	n/a	1066, 1333,	n/a	1066, 1333	n/a	1066	
SRx8 ECC	1GB	2GB	4GB	1066, 1333	1066, 1333,	1066, 1333	1066, 1333	1066	1066	
DRx8 ECC	2GB	4GB	8GB	1066, 1333	1066, 1333,	1066, 1333	1066, 1333	1066	1066	

**Notes:**

1. Supported DRAM Densities are 1Gb, 2Gb and 4Gb. Only 2Gb and 4Gb are validated by Intel.
2. Command Address Timing is 1N for 1DPC and 2N for 2DPC.
3. For Memory Population Rules, please refer to the *Romley Platform Design Guide*.

	Supported and Validated
	Supported but not Validated

**Table 5. RDIMM Support Guidelines**

Ranks Per DIMM & Data Width	Memory Capacity Per DIMM1			Speed (MT/s) and Voltage Validated by Slot per Channel (SPC) and DIMM Per Channel (DPC)2,3					
				1 Slot per Channel		2 Slots per Channel			
				1DPC		1DPC		2DPC	
				1.35V	1.5V	1.35V	1.5V	1.35V	1.5V
SRx8	1GB	2GB	4GB	1066 1333	1066 1333 1600	1066 1333	1066 1333 1600	1066 1333	1066 1333 1600
DRx8	2GB	4GB	8GB	1066 1333	1066 1333 1600	1066 1333	1066 1333 1600	1066 1333	1066 1333 1600
SRx4	2GB	4GB	8GB	1066 1333	1066 1333 1600	1066 1333	1066 1333 1600	1066 1333	1066 1333 1600
DRx4	4GB	8GB	16GB	1066 1333	1066 1333 1600	1066 1333	1066 1333 1600	1066 1333	1066 1333 1600

**Notes:**

1. Supported DRAM Densities are 1Gb, 2Gb and 4Gb. Only 2Gb and 4Gb are validated by Intel.
2. Command Address Timing is 1N.
3. For Memory Population Rules, please refer to the *Romley Platform Design Guide*.

	Supported and Validated
	Supported but not Validated

**3.2.2.2 Memory population rules**

**Note:** Although mixed DIMM configurations are supported, Intel only performs platform validation on systems that are configured with identical DIMMs installed.

Each processor provides three channels of memory, each capable of supporting up to two DIMMs.

- DIMMs are organized into physical slots on DDR3 memory channels that belong to processor sockets.
- The memory channels from processor socket 1 are identified as Channel A, B and C. The memory channels from processor socket 2 are identified as Channel D, E and F.
- The silk screened DIMM slot identifiers on the board provide information about the channel, and therefore the processor to which they belong. For example, DIMM\_A1 is the first slot on Channel A on processor 1; DIMM\_D1 is the first DIMM socket on Channel D on processor 2.
- The memory slots associated with a given processor are unavailable if the corresponding processor socket is not populated.
- A processor may be installed without populating the associated memory slots provided a second processor is installed with associated memory. In this case, the memory is shared by the processors. However, the platform suffers performance degradation and latency due to the remote memory.

- Processor sockets are self-contained and autonomous. However, all memory subsystem support (such as Memory RAS, Error Management,) in the BIOS setup are applied commonly across processor sockets.

On the Intel® Server Board S2400SC, a total of 8 DIMM slots is provided (two CPUs – 3 Channels/CPU). The nomenclature for DIMM sockets is detailed in the following table:

**Table 6. Intel® Server Board S2400SC DIMM Nomenclature**

Processor Socket 1				Processor Socket 2			
(0) Channel A	(1) Channel B	(2) Channel C		(0) Channel D	(1) Channel E	(2) Channel F	
A1	B1	C1	C2	D1	E1	F1	F2

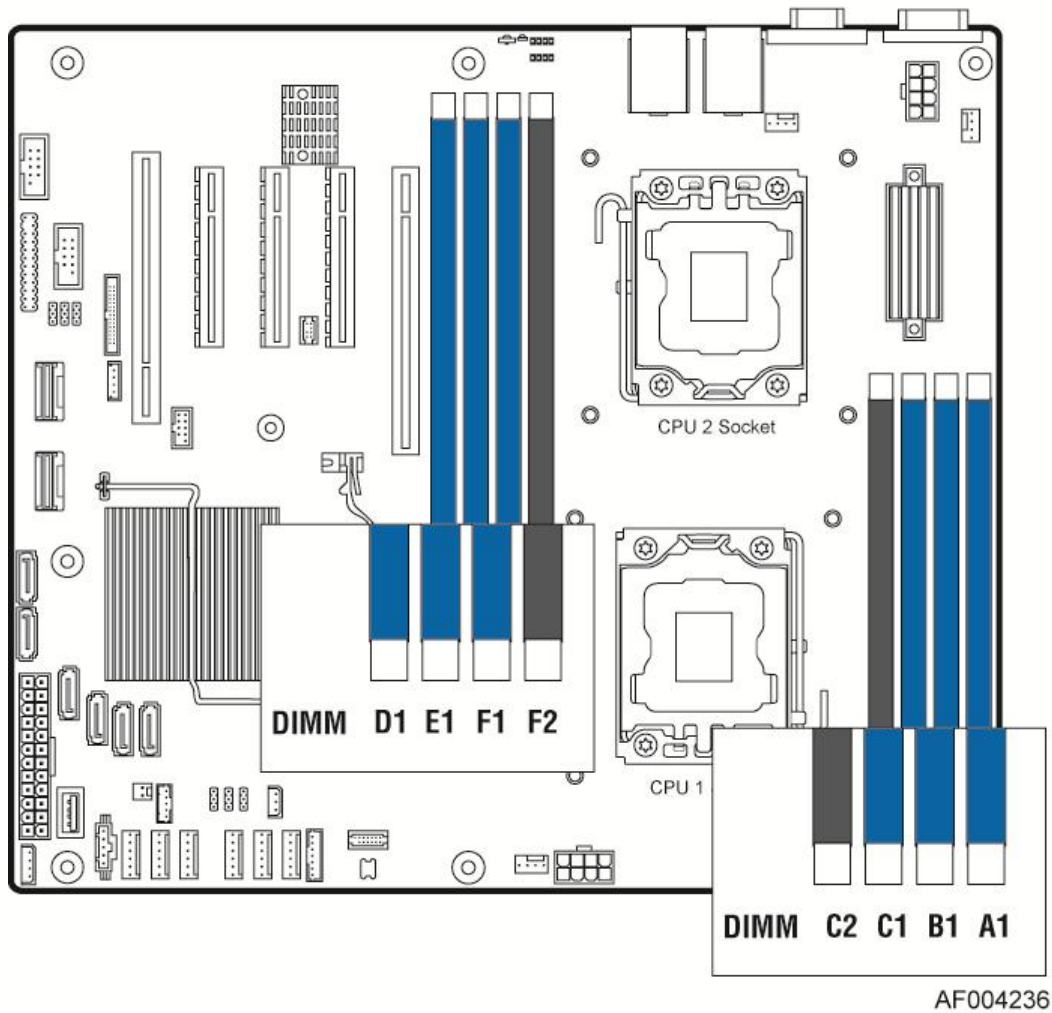

**Figure 14. Intel® Server Board S2400SC DIMM Slot Layout**

The following are generic DIMM population requirements that generally apply to the Intel® Server Board S2400SC.

- All DIMMs must be DDR3 DIMMs
- Registered DIMMs must be ECC only. Unbuffered DIMMs can be ECC or non-ECC. However, Intel only validates and supports ECC memory for its server products.
- Mixing of Registered and Unbuffered DIMMs is not allowed per platform.
- Mixing of DDR3 voltages is not validated within a socket or across sockets by Intel. If 1.35V (DDR3L) and 1.50V (DDR3) DIMMs are mixed, the DIMMs will run at 1.50V.
- Mixing of DDR3 operating frequencies is not validated within a socket or across sockets by Intel. If DIMMs with different frequencies are mixed, all DIMMs will run at the common lowest frequency.
- Quad rank DIMMs are NOT supported.
- LR (Load Reduced) DIMMs are NOT supported.
- A maximum of 8 logical ranks (ranks seen by the host) per channel is allowed.
- Mixing of ECC and non-ECC DIMMs is not allowed per platform.
- DIMMs with different timing parameters can be installed on different slots within the same channel, but only timings that support the slowest DIMM will be applied to all. As a consequence, faster DIMMs will be operated at timings supported by the slowest DIMM populated.
- When one DIMM is used, it must be populated in the BLUE DIMM slot (farthest away from the CPU) of a given channel.
- When single and dual rank DIMMs are populated for 2DPC, always populate the higher number rank DIMM first (starting from the farthest slot), for example, first dual rank, and then single rank DIMM.

DIMM population rules require that DIMMs within a channel be populated starting with the BLUE DIMM slot or DIMM farthest from the processor in a “fill-farthest” approach. Intel MRC will check for correct DIMM placement.

### 3.2.2.3 Publishing System Memory

- The BIOS displays the “Total Memory” of the system during POST if Display Logo is disabled in the BIOS setup. This is the total size of memory discovered by the BIOS during POST, and is the sum of the individual sizes of installed DDR3 DIMMs in the system.
- The BIOS displays the “Effective Memory” of the system in the BIOS setup. The term *Effective Memory* refers to the total size of all DDR3 DIMMs that are active (not disabled) and not used as redundant units.
- The BIOS provides the total memory of the system in the main page of the BIOS setup. This total is the same as the amount described by the first bullet above.
- If Display Logo is disabled, the BIOS displays the total system memory on the diagnostic screen at the end of POST. This total is the same as the amount described by the first bullet above.

**Note:** Some server operating systems do not display the total physical memory installed. What is displayed is the amount of physical memory minus the approximate memory space used by system BIOS components. These BIOS components include, but are not limited to:

1. ACPI (may vary depending on the number of PCI devices detected in the system)
2. ACPI NVS table
3. Processor microcode
4. Memory Mapped I/O (MMIO)
5. Manageability Engine (ME)
6. BIOS flash

### **3.2.2.3.1 RAS Features**

The server board supports the following memory RAS modes:

- Independent Channel Mode
- Rank Sparing Mode
- Mirrored Channel Mode
- Lockstep Channel Mode
- Single Device Data Correction (SDDC)
- Error Correction Code (ECC) Memory
- Demand Scrubbing for ECC Memory
- Patrol Scrubbing for ECC Memory

Regardless of RAS mode, the requirements for populating within a channel given in the section 3.2.2.2 must be met at all times. Note that support of RAS modes that require matching DIMM population between channels (Mirrored and Lockstep) require that ECC DIMMs be populated. Independent Channel Mode is the only mode that supports non-ECC DIMMs in addition to ECC DIMMs.

For RAS modes that require matching populations, the same slot positions across channels must hold the same DIMM type with regards to size and organization. DIMM timings do not have to match but timings will be set to support all DIMMs populated (that is, DIMMs with slower timings will force faster DIMMs to the slower common timing modes).

#### **3.2.2.3.2 Independent Channel Mode**

In non-ECC and x4 SDDC configurations, each channel is running independently (nonlock-step), that is, each cache-line from memory is provided by a channel. To deliver the 64-byte cache-line of data, each channel is bursting eight 8-byte chunks. Back to back data transfer in the same direction and within the same rank can be sent back-to-back without any dead-cycle. The independent channel mode is the recommended method to deliver most efficient power and bandwidth as long as the x8 SDDC is not required.

#### **3.2.2.3.3 Rank Sparing Mode**

In Rank Sparing Mode, one rank is a spare of the other ranks on the same channel. The spare rank is held in reserve and is not available as system memory. The spare rank must have identical or larger memory capacity than all the other ranks (sparing source ranks) on the same channel. After sparing, the sparing source rank will be lost.

Rank Sparing Mode enhances the system's RAS capability by "swapping out" failing ranks of DIMMs. Rank Sparing is strictly channel and rank oriented. Each memory channel is a Sparing Domain.

For Rank Sparing to be available as a RAS option, there must be 2 or more single rank or dual rank DIMMs, or at least one quad rank DIMM installed on each memory channel.

Rank Sparing Mode is enabled or disabled in the Memory RAS and Performance Configuration screen in the <F2> Bios Setup Utility

When Sparing Mode is operational, for each channel, the largest size memory rank is reserved as a "spare" and is not used during normal operations. The impact on Effective Memory Size is to subtract the sum of the reserved ranks from the total amount of installed memory.

Hardware registers count the number of Correctable ECC Errors for each rank of memory on each channel during operations and compare the count against a Correctable Error Threshold. When the correctable error count for a given rank hits the threshold value, that rank is deemed to be "failing", and it triggers a Sparing Fail Over (SFO) event for the channel in which that rank resides. The data in the failing rank is copied to the Spare Rank for that channel, and the Spare Rank replaces the failing rank in the IMC's address translation registers.

An SFO Event is logged to the BMC SEL. The failing rank is then disabled, and any further Correctable Errors on that now non-redundant channel will be disregarded.

The correctable error that triggered the SFO may be logged to the BMC SEL, if it was the first one to occur in the system. That first correctable error event will be the only one logged for the system. However, since each channel is a Sparing Domain, the correctable error counting continues for other channels which are still in a redundant state. There can be as many SFO Events as there are memory channels with DIMMs installed.

#### **3.2.2.3.4 Mirrored Channel Mode**

Channel Mirroring Mode gives the best memory RAS capability by maintaining two copies of the data in main memory. If there is an Uncorrectable ECC Error, the channel with the error is disabled and the system continues with the "good" channel, but in a non-redundant configuration.

For Mirroring mode to be available as a RAS option, the DIMM population must be identical between each pair of memory channels that participate. Not all channel pairs need to have memory installed, but for each pair, the configuration must match. If the configuration is not matched up properly, the memory operating mode falls back to Independent Channel Mode.

Mirroring Mode is enabled/disabled in the Memory RAS and Performance Configuration screen in the <F2> BIOS Setup Utility.

When Mirroring Mode is operational, each channel in a pair is "mirrored" by the other channel. The impact on Effective Memory size is to reduce by half the total amount of installed memory available for use.

When Mirroring Mode is operational, the system treats Correctable Errors the same way as it would in Independent channel mode. There is a correctable error threshold. Correctable error counts accumulate by rank, and the first event is logged.

What Mirroring primarily protects against is the possibility of an Uncorrectable ECC Error occurring with critical data “in process”. Without Mirroring, the system would be expected to “Blue Screen” and halt, possibly with serious impact to operations. But with Mirroring Mode in operation, an Uncorrectable ECC Error from one channel becomes a Mirroring Fail Over (MFO) event instead, in which the IMC retrieves the correct data from the “mirror image” channel and disables the failed channel. Since the ECC Error was corrected in the process of the MFO Event, the ECC Error is demoted to a Correctable ECC Error. The channel pair becomes a single non-redundant channel, but without impacting operations, and the Mirroring Fail Over Event is logged to SEL to alert the user that there is memory hardware that has failed and needs to be replaced.

In Mirrored Channel Mode, the memory contents are mirrored between Channel B and Channel C and also between Channel E and Channel F. As a result of the mirroring, the total physical memory available to the system is half of what is populated. Mirrored Channel Mode requires that Channel B and Channel C, and Channel E and Channel F must be populated identically with regards to size and organization. DIMM slot populations within a channel do not have to be identical but the same DIMM slot location across Channel B and Channel C and across Channel E and Channel F must be populated the same.

### **3.2.2.3.5 Lockstep Channel Mode**

In lockstep channel mode the cache-line is split across channels. This is done to support Single Device Data Correction (SDDC) for DRAM devices with 8-bit wide data ports. Also, the same address is used on both channels, such that an address error on any channel is detectable by bad ECC. The iMC module always accumulates 32-bytes before forwarding data so there is no latency benefit for disabling ECC.

Lockstep channels must be populated identically. That is, each DIMM in one channel must have a corresponding DIMM of identical organization (number ranks, number banks, number rows, number columns). DIMMs may be of different speed grades, but the iMC module will be configured to operate all DIMMs according to the slowest parameters present by the Memory Reference Code (MRC).

Performance in lockstep mode cannot be as high as with independent channels. The burst length for DDR3 DIMMs is eight which is shared between two channels that are in lockstep mode. Each channel of the pair provides 32 bytes to produce the 64-byte cache-line. DRAMs on independent channels are configured to deliver a burst length of eight. The maximum read bandwidth for a given Rank is half of peak. There is another draw back in using lockstep mode, that is, higher power consumption since the total activation power is about twice of the independent channel operation if comparing to same type of DIMMs.

In Lockstep Channel Mode, each memory access is a 128-bit data access that spans Channel B and Channel C, and Channel E and Channel F. Lockstep Channel mode is the only RAS mode that allows SDDC for x8 devices. Lockstep Channel Mode requires that Channel B and Channel C, and Channel E and Channel F must be populated identically with regards to size and organization. DIMM slot populations within a channel do not have to be identical but the same

DIMM slot location across Channel B and Channel C and across Channel E and Channel F must be populated the same.

#### **3.2.2.4 Single Device Data Correction (SDDC)**

SDDC – Single Device Data Correction is a technique by which data can be replaced by the IMC from an entire x4 DRAM device which is failing, using a combination of CRC plus parity. This is an automatic IMC driven hardware. It can be extended to x8 DRAM technology by placing the system in Channel Lockstep Mode.

#### **3.2.2.5 Error Correction Code (ECC) Memory**

ECC uses “extra bits” – 64-bit data in a 72-bit DRAM array – to add an 8-bit calculated “Hamming Code” to each 64 bits of data. This additional encoding enables the memory controller to detect and report single or multiple bit errors when data is read, and to correct single-bit errors.

##### ***3.2.2.5.1 Correctable Memory ECC Error Handling***

A “Correctable ECC Error” is one in which a single-bit error in memory contents is detected and corrected by use of the ECC Hamming Code included in the memory data. For a correctable error, data integrity is preserved, but it may be a warning sign of a true failure to come. Note that some correctable errors are expected to occur.

The system BIOS has logic to cope with the random factor in correctable ECC errors. Rather than reporting every correctable error that occurs, the BIOS has a threshold and only logs a correctable error when a threshold value is reached. Additional correctable errors that occur after the threshold has been reached are disregarded. In addition, on the expectation the server system may have extremely long operational runs without being rebooted, there is a “Leaky Bucket” algorithm incorporated into the correctable error counting and comparing mechanism. The “Leaky Bucket” algorithm reduces the correctable error count as a function of time – as the system remains running for a certain amount of time, the correctable error count will “leak out” of the counting registers. This prevents correctable error counts from building up over an extended runtime.

The correctable memory error threshold value is a configurable option in the <F2> BIOS Setup Utility, where you can configure it for 20/10/5/ALL/None

Once a correctable memory error threshold is reached, the event is logged to the System Event Log (SEL) and the appropriate memory slot fault LED is lit to indicate on which DIMM the correctable error threshold crossing occurred.

##### ***3.2.2.5.2 Uncorrectable Memory ECC Error Handling***

All multi-bit “detectable but not correctable” memory errors are classified as Uncorrectable Memory ECC Errors. This is generally a fatal error.

However, before returning control to the OS drivers through Machine Check Exception (MCE) or Non-Maskable Interrupt (NMI), the Uncorrectable Memory ECC Error is logged to the SEL, the appropriate memory slot fault LED is lit, and the System Status LED state is changed to solid Amber.



### 3.2.2.6 Demand Scrubbing for ECC Memory

Demand scrubbing is the ability to write corrected data back to the memory once a correctable error is detected on a read transaction. This allows for correction of data in memory at detect, and decrease the chances of a second error on the same address accumulating to cause a multi-bit error (MBE) condition.

Demand Scrubbing is enabled/disabled (default is enabled) in the Memory Configuration screen in Setup.

### 3.2.2.7 Patrol Scrubbing for ECC Memory

Patrol scrubs are intended to ensure that data with a correctable error does not remain in DRAM long enough to stand a significant chance of further corruption to an uncorrectable stage.

## 3.2.3 Processor Integrated I/O Module (IIO)

The processor's integrated I/O module provides features traditionally supported through chipset components. The integrated I/O module provides the following features:

- **PCI Express Interfaces:**

The integrated I/O module incorporates the PCI Express interface and supports up to 24 lanes of PCI Express. Following are key attributes of the PCI Express interface:

- Gen3 speeds at 8 GT/s (no 8b/10b encoding)

The Intel® Server Board S2400SC supports PCIe slots from two processors:

- From first processor:
  - Slot 4: PCIe Gen3 x4 electrical with x8 physical connector
  - Slot 6: PCIe Gen3 x16 electrical with x16 physical connector
- From second processor
  - Slot 5: PCIe Gen3 x8 electrical with x8 open-ended physical connector

- **DMI2 Interface to the PCH:** The platform requires an interface to the legacy Southbridge (PCH) which provides basic, legacy functions required for the server platform and operating systems. Since only one PCH is required and allowed for the system, any sockets which do not connect to PCH would use this port as a standard x4 PCI Express 2.0 interface.
- **Integrated IOAPIC:** Provides support for PCI Express devices implementing legacy interrupt messages without interrupt sharing.
- **Non Transparent Bridge:** PCI Express non-transparent bridge (NTB) acts as a gateway that enables high performance, low overhead communication between two intelligent subsystems; the local and the remote subsystems. The NTB allows a local processor to independently configure and control the local subsystem, provides isolation of the local host memory domain from the remote host memory domain while enabling status and data exchange between the two domains.
- **Intel® QuickData Technology:** Used for efficient, high bandwidth data movement between two locations in memory or from memory to I/O.

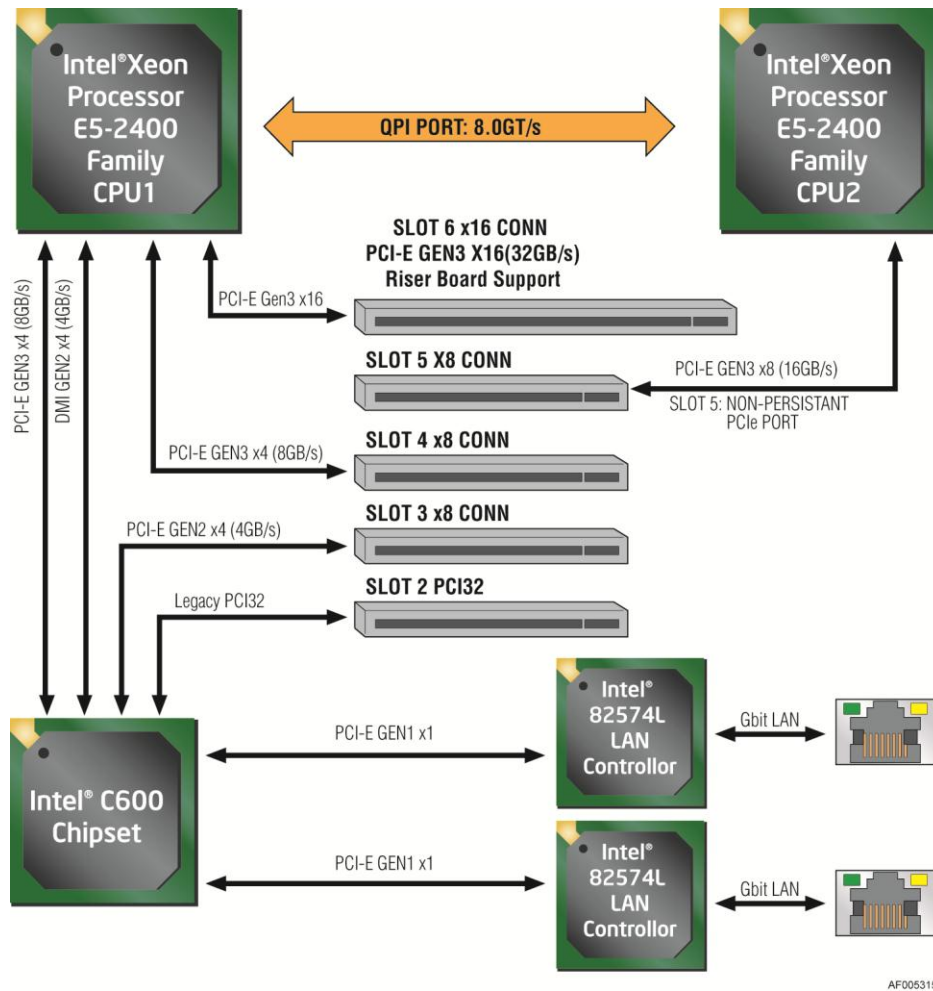

**Figure 15. Functional Block Diagram of Processor I/O Sub-system**

The following sub-sections will describe the server board features that are directly supported by the processor I/O module. These include the Riser Card Slots, Network Interface, and connectors for the optional I/O modules and SAS Module. Features and functions of the Intel C600 Series chipset will be described in its own dedicated section.

### 3.2.3.1 Network Interface

Network connectivity is provided by means of two onboard Intel® Ethernet Controller 82574L providing up to two 10/100/1000 Mb Ethernet ports. The NIC chip is supported by implementing x1 PCIe Gen1 signals from the Intel® C600 PCH.

On the Intel® Server Board S2400SC, two external 10/100/1000 Mb RJ45 Ethernet ports are provided. Each Ethernet port drives two LEDs located on each network interface connector. The LED at the right of the connector is the link/activity LED and indicates network connection when on, and transmit/receive activity when blinking. The LED at the left of the connector indicates link speed as defined in the following table:

**Table 7. External RJ45 NIC Port LED Definition**

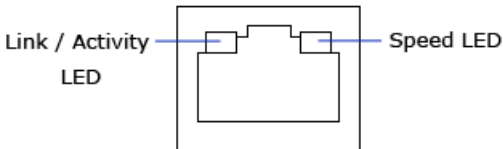
		
LED Color	LED State	NIC State
Green/Amber (Right)	▪ Off	▪ 10 Mbps
	▪ Amber	▪ 100 Mbps
	▪ Green	▪ 1000 Mbps
Green (Left)	▪ On	▪ Active Connection
	▪ Blinking	▪ Transmit/Receive activity

### 3.3 Intel® C602-A Chipset Functional Overview

The following sub-sections will provide an overview of the key features and functions of the Intel® C602-A chipset used on the server board. For more comprehensive chipset specific information, refer to the Intel® C600 Series chipset documents listed in the Reference Document list in Chapter 1.

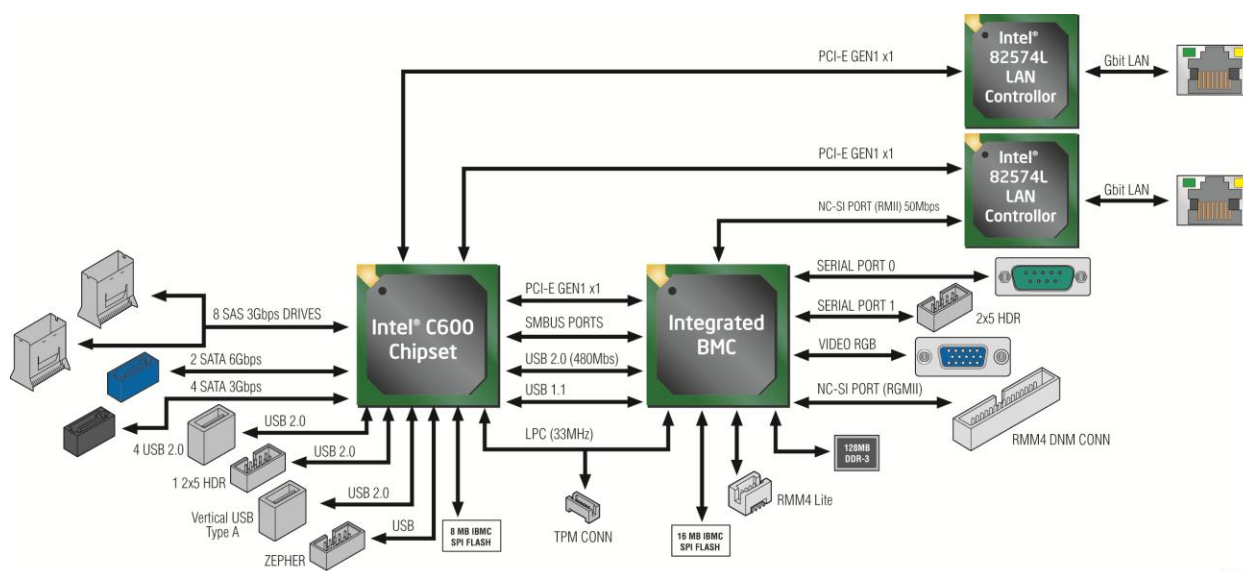

**Figure 16. Functional Block Diagram – Chipset Supported Features and Functions**

On the Intel® Server Boards S2400SC, the chipset provides support for the following on-board functions:

- Digital Media Interface (DMI)
- PCI Express\* Interface
- Serial ATA (SATA) Controller
- Serial Attached SCSI (SAS)/SATA Controller
- AHCI

- Rapid Storage Technology
- PCI Interface
- Low Pin Count (LPC) interface
- Serial Peripheral Interface (SPI)
- Compatibility Modules (DMA Controller, Timer/Counters, Interrupt Controller)
- Advanced Programmable Interrupt Controller (APIC)
- Universal Serial Bus (USB) Controller
- Gigabit Ethernet Controller
- RTC
- GPIO
- Enhanced Power Management
- Manageability
- System Management Bus (SMBus\* 2.0)
- Intel® Active Management Technology (Intel® AMT)
- Integrated NVSRAM controller
- Virtualization Technology for Direct I/O (Intel® VT-d)
- JTAG Boundary-Scan
- KVM/Serial Over LAN (SOL) Function

### 3.3.1 Digital Media Interface (DMI)

Digital Media Interface (DMI) is the chip-to-chip connection between the processor and C600 chipset. This high-speed interface integrates advanced priority-based servicing allowing for concurrent traffic and true isochronous transfer capabilities. Base functionality is completely software-transparent, permitting current and legacy software to operate normally.

### 3.3.2 PCI Express\* Interface

The C600 chipset provides up to 8 PCI Express\* Root Ports, supporting the *PCI Express Base Specification*, Revision 2.0. Each Root Port x1 lane supports up to 5 Gb/s bandwidth in each direction (10 Gb/s concurrent). PCI Express\* Root Ports 1-4 or Ports 5-8 can independently be configured to support four x1s, two x2s, one x2 and two x1s, or one x4 port widths.

### 3.3.3 Serial ATA (SATA) Controller

The C600 chipset has two integrated SATA host controllers that support independent DMA operation on up to six ports and supports data transfer rates of up to 6.0 Gb/s (600 MB/s) on up to two ports (Port 0 and 1 Only) while all ports support rates up to 3.0 Gb/s (300 MB/s) and up to 1.5 Gb/s (150 MB/s). The SATA controller contains two modes of operation – a legacy mode using I/O space, and an AHCI mode using memory space. Software that uses legacy mode will not have AHCI capabilities. The C600 chipset supports the *Serial ATA Specification*, Revision 3.0. The C600 also supports several optional sections of the *Serial ATA II: Extensions to Serial ATA 1.0 Specification*, Revision 1.0 (AHCI support is required for some elements).

### 3.3.4 AHCI

The C600 chipset provides hardware support for Advanced Host Controller Interface (AHCI), a standardized programming interface for SATA host controllers. Platforms supporting AHCI may take advantage of performance features such as no master/slave designation for SATA devices—each device is treated as a master—and hardware assisted native command queuing. AHCI also provides usability enhancements such as Hot-Plug. AHCI requires appropriate software support (for example, an AHCI driver) and for some features, hardware support in the SATA device or additional platform hardware.

### 3.3.5 Rapid Storage Technology

The C600 chipset provides support for Intel® Rapid Storage Technology, providing both AHCI (see above for details on AHCI) and integrated RAID functionality. The industry-leading RAID capability provides high-performance RAID 0, 1, 5, and 10 functionality on up to 6 SATA ports of the C600 chipset. Matrix RAID support is provided to allow multiple RAID levels to be combined on a single set of hard drives, such as RAID 0 and RAID 1 on two disks. Other RAID features include hot-spare support, SMART alerting, and RAID 0 auto replace. Software components include an Option ROM for pre-boot configuration and boot functionality, a Microsoft Windows\* compatible driver, and a user interface for configuration and management of the RAID capability of the C600 chipset.

### 3.3.6 PCI Interface

The C600 chipset PCI interface provides a 33 MHz, Revision 2.3 implementation. The C600 chipset integrates a PCI arbiter that supports up to four external PCI bus masters in addition to the internal C600 chipset requests. This allows for combinations of up to four PCI down devices and PCI slots.

### 3.3.7 Low Pin Count (LPC) Interface

The C600 chipset implements an LPC Interface as described in the *LPC 1.1 Specification*. The Low Pin Count (LPC) bridge function of the C600 resides in PCI Device 31: Function 0. In addition to the LPC bridge interface function, D31:F0 contains other functional units including DMA, interrupt controllers, timers, power management, system management, GPIO, and RTC.

### 3.3.8 Serial Peripheral Interface (SPI)

The C600 chipset implements an SPI Interface as an alternative interface for the BIOS flash device. An SPI flash device can be used as a replacement for the FWH, and is required to support Gigabit Ethernet and Intel® Active Management Technology. The C600 chipset supports up to two SPI flash devices with speeds up to 50 MHz, utilizing two chip select pins.

### 3.3.9 Compatibility Modules (DMA Controller, Timer/Counters, Interrupt Controller)

The DMA controller incorporates the logic of two 82C37 DMA controllers, with seven independently programmable channels. Channels 0–3 are hardwired to 8-bit, count-by-byte transfers, and channels 5–7 are hardwired to 16-bit, count-by-word transfers. Any two of the seven DMA channels can be programmed to support fast Type-F transfers. Channel 4 is reserved as a generic bus master request.

The C600 chipset supports LPC DMA, which is similar to ISA DMA, through the C600 chipset's DMA controller. LPC DMA is handled through the use of the LDRQ# lines from peripherals and special encoding on LAD[3:0] from the host. Single, Demand, Verify, and Increment modes are supported on the LPC interface.

The timer/counter block contains three counters that are equivalent in function to those found in one 82C54 programmable interval timer. These three counters are combined to provide the system timer function, and speaker tone. The 14.31818 MHz oscillator input provides the clock source for these three counters.

The C600 chipset provides an ISA-Compatible Programmable Interrupt Controller (PIC) that incorporates the functionality of two, 82C59 interrupt controllers. The two interrupt controllers are cascaded so that 14 external and two internal interrupts are possible. In addition, the C600 chipset supports a serial interrupt scheme.

### 3.3.10 Advanced Programmable Interrupt Controller (APIC)

In addition to the standard ISA compatible Programmable Interrupt controller (PIC) described in the previous section, the C600 incorporates the Advanced Programmable Interrupt Controller (APIC).

### 3.3.11 Universal Serial Bus (USB) Controller

The C600 chipset has up to two Enhanced Host Controller Interface (EHCI) host controllers that support USB high-speed signaling. High-speed USB 2.0 allows data transfers up to 480 Mb/s which is 40 times faster than full-speed USB. The C600 chipset supports up to fourteen USB 2.0 ports. All fourteen ports are high-speed, full-speed, and low-speed capable.

### 3.3.12 Gigabit Ethernet Controller

The Gigabit Ethernet Controller provides a system interface using a PCI function. The controller provides a full memory-mapped or IO mapped interface along with a 64 bit address master support for systems using more than 4 GB of physical memory and DMA (Direct Memory Addressing) mechanisms for high performance data transfers. Its bus master capabilities enable the component to process high-level commands and perform multiple operations; this lowers processor utilization by off-loading communication tasks from the processor. Two large configurable transmit and receive FIFOs (up to 20 KB each) help prevent data underruns and overruns while waiting for bus accesses. This enables the integrated LAN controller to transmit data with minimum interframe spacing (IFS).

The LAN controller can operate at multiple speeds (10/100/1000 MB/s) and in either full duplex or half duplex mode. In full duplex mode the LAN controller adheres with the *IEEE 802.3x Flow Control Specification*. Half duplex performance is enhanced by a proprietary collision reduction mechanism.

### 3.3.13 RTC

The C600 chipset contains a Motorola MC146818B-compatible real-time clock with 256 bytes of battery-backed RAM. The real-time clock performs two key functions: keeping track of the time of day and storing system data, even when the system is powered down. The RTC operates on a 32.768 KHz crystal and a 3 V battery. The RTC also supports two lockable memory ranges. By setting bits in the configuration space, two 8-byte ranges can be locked to read and write accesses. This prevents unauthorized reading of passwords or other system security information. The RTC also supports a date alarm that allows for scheduling a wake up event up to 30 days in advance, rather than just 24 hours in advance.

### 3.3.14 GPIO

Various general purpose inputs and outputs are provided for custom system design. The number of inputs and outputs varies depending on the C600 chipset configuration.

### 3.3.15 Enhanced Power Management

The C600 chipset's power management functions include enhanced clock control and various low-power (suspend) states (for example, Suspend-to-RAM and Suspend-to-Disk). A hardware-based thermal management circuit permits software-independent entrance to low-power states. The C600 chipset contains full support for the *Advanced Configuration and Power Interface (ACPI) Specification*, Revision 4.0a.

### 3.3.16 Manageability

The chipset integrates several functions designed to manage the system and lower the total cost of ownership (TCO) of the system. These system management functions are designed to report errors, diagnose the system, and recover from system lockups without the aid of an external microcontroller.

- **TCO Timer.** The chipset's integrated programmable TCO timer is used to detect system locks. The first expiration of the timer generates an SMI# that the system can use to recover from a software lock. The second expiration of the timer causes a system reset to recover from a hardware lock.
- **Processor Present Indicator.** The chipset looks for the processor to fetch the first instruction after reset. If the processor does not fetch the first instruction, the chipset will reboot the system.
- **ECC Error Reporting.** When detecting an ECC error, the host controller has the ability to send one of several messages to the chipset. The host controller can instruct the chipset to generate SMI#, NMI, SERR#, or TCO interrupt.
- **Function Disable.** The chipset provides the ability to disable the following integrated functions: LAN, USB, LPC, SATA, PCI Express\* or SMBus\*. Once disabled, these functions no longer decode I/O, memory, or PCI configuration space. Also, no interrupts or power management events are generated from the disabled functions.
- **Intruder Detect.** The chipset provides an input signal (INTRUDER#) that can be attached to a switch that is activated by the system case being opened. The chipset can be programmed to generate an SMI# or TCO interrupt due to an active INTRUDER# signal.

### 3.3.17 System Management Bus (SMBus\* 2.0)

The C600 chipset contains a SMBus\* Host interface that allows the processor to communicate with SMBus\* slaves. This interface is compatible with most I2C devices. Special I2C commands are implemented. The C600 chipset's SMBus\* host controller provides a mechanism for the processor to initiate communications with SMBus\* peripherals (slaves). Also, the C600 chipset supports slave functionality, including the Host Notify protocol. Hence, the host controller supports eight command protocols of the SMBus\* interface (see *System Management Bus (SMBus\*) Specification, Version 2.0*): Quick Command, Send Byte, Receive Byte, Write Byte/Word, Read Byte/Word, Process Call, Block Read/Write, and Host Notify.

The C600 chipset's SMBus\* also implements hardware-based Packet Error Checking for data robustness and the Address Resolution Protocol (ARP) to dynamically provide address to all SMBus\* devices.

### 3.3.18 Intel® Active Management Technology (Intel® AMT)

Intel® Active Management Technology (Intel® AMT) is the next generation of client manageability using the wired network. Intel AMT is a set of advanced manageability features developed as a direct result of IT customer feedback gained through Intel market research. With the new implementation of System Defense in C600 chipset, the advanced manageability feature set of Intel AMT is further enhanced.

### 3.3.19 Integrated NVSRAM Controller

The C600 chipset has an integrated NVSRAM controller that supports up to 32KB external device. The host processor can read and write data to the NVSRAM component.

### 3.3.20 Intel® Virtualization Technology for Direct I/O (Intel® VT-d)

The C600 chipset provides hardware support for implementation of Intel® Virtualization Technology with Directed I/O (Intel® VT-d). Intel VT-d consists of technology components that support the virtualization of platforms based on Intel® Architecture Processors. Intel VT-d Technology enables multiple operating systems and applications to run in independent partitions. A partition behaves like a virtual machine (VM) and provides isolation and protection across partitions. Each partition is allocated its own subset of host physical memory.

### 3.3.21 JTAG Boundary-Scan

The C600 chipset adds the industry standard JTAG interface and enables Boundary-Scan in place of the XOR chains used in previous generations of chipsets. Boundary-Scan can be used to ensure device connectivity during the board manufacturing process. The JTAG interface allows system manufacturers to improve efficiency by using industry available tools to test the C600 chipset on an assembled board. Since JTAG is a serial interface, it eliminates the need to create probe points for every pin in an XOR chain. This eases pin breakout and trace routing and simplifies the interface between the system and a bed-of-nails tester.

### 3.3.22 KVM/Serial Over LAN (SOL) Function

These functions support redirection of keyboard, mouse, and text screen to a terminal window on a remote console. The keyboard, mouse, and text redirection enables the control of the client



machine through the network without the need to be physically near that machine. Text, mouse, and keyboard redirection allows the remote machine to control and configure the client by entering BIOS setup. The KVM/SOL function emulates a standard PCI serial port and redirects the data from the serial port to the management console using LAN. KVM has additional requirements of internal graphics and SOL may be used when KVM is not supported.

### 3.3.23 On-board Serial Attached SCSI (SAS)/Serial ATA (SATA) Support and Options

The Intel® C602-A chipset provides storage support by means of two integrated controllers: AHCI and SCU. By default the server board will support up to 10 SATA ports: Two single 6Gb/sec SATA ports routed from the AHCI controller to the two white SATA connectors labeled “SATA\_0” and “SATA\_1”, four 3Gb/sec SATA ports routed from the AHCI controller to the four black SATA connectors labeled “SATA\_2” to “SATA\_5”, and four 3Gb/sec SATA ports routed from the SCU to the SFF8087 miniSAS port labeled “SCU\_0”.

**Note:** The miniSAS connector labeled “SCU 1” is NOT functional by default and is only enabled with the addition of an Intel® RAID C600 Upgrade Key option supporting eight SAS/SATA ports.

Standard are two embedded software RAID options using the storage ports configured from the SCU only:

- Intel® Embedded Server RAID Technology 2 (ESRT2) based on LSI\* MegaRAID SW RAID technology supporting SATA RAID levels 0,1,10
- Intel® Rapid Storage Technology (RSTe) supporting SATA RAID levels 0,1,5,10

The server board is capable of supporting additional chipset embedded SAS and RAID options from the SCU controller when configured with one of several available Intel® RAID C600 Upgrade Keys. Upgrade keys install onto a 4-pin connector on the server board labeled “STOR\_UPG\_KEY”. The following table identifies available upgrade key options and their supported features.

**Table 8. Intel® RAID C600 Upgrade Key Options**

Product Code	Color	On-Server Board SATA/SAS Capable Controller	On-Server Board AHCI Capable SATA Controller
No Key	N/A	Intel® RSTe 4 ports SATA R0,1,10,5 or Intel® ESRT2 4 ports SATA R0,1,10	Intel® RSTe SATA R0,1,10,5 or Intel® ESRT2 SATA R0,1,10
RKSATA4R5	Black	Intel® RSTe 4 ports SATA R0,1,10,5 or Intel® ESRT2 4 ports SATA R0,1,10,5	Intel® RSTe SATA R0,1,10,5 or Intel® ESRT2 SATA R0,1,10,5
RKSATA8	Blue	Intel® RSTe 8 ports SATA R0,1,10,5 or Intel® ESRT2 8 ports SATA R0,1,10	Intel® RSTe SATA R0,1,10,5 or Intel® ESRT2 SATA R0,1,10
RKSATA8R5	White	Intel® RSTe 8 ports SATA R0,1,10,5 or Intel® ESRT2 8 ports SATA R0,1,10,5	Intel® RSTe SATA R0,1,10,5 or Intel® ESRT2 SATA R0,1,10,5
RKSAS4	Green	Intel® RSTe 4 ports SAS R0,1,10 or Intel® ESRT2 4 ports SAS R0,1,10	Intel® RSTe SATA R0,1,10,5 or Intel® ESRT2 SATA R0,1,10

Product Code	Color	On-Server Board SATA/SAS Capable Controller	On-Server Board AHCI Capable SATA Controller
RKSAS4R5	Yellow	Intel® RSTE 4 ports SAS R0,1,10 or Intel® ESRT2 4 ports SAS R0,1,10,5	Intel® RSTE SATA R0,1,10,5 or Intel® ESRT2 SATA R0,1,10,5
RKSAS8	Orange	Intel® RSTE 8 ports SAS R0,1,10 or Intel® ESRT2 8 ports SAS R0,1,10	Intel® RSTE SATA R0,1,10,5 or Intel® ESRT2 SATA R0,1,10
RKSAS8R5	Purple	Intel® RSTE 8 ports SAS R0,1,10 or Intel® ESRT2 8 ports SAS R0,1,10,5	Intel® RSTE SATA R0,1,10,5 or Intel® ESRT2 SATA R0,1,10,5

Additional information for the on-board RAID features and functionality can be found in the *Intel® RAID Software Users Guide* (Intel Document Number D29305-018).

The system includes support for two embedded software RAID options:

- Intel® Embedded Server RAID Technology 2 (ESRT2) based on LSI\* MegaRAID SW RAID technology
- Intel® Rapid Storage Technology (RSTe)

Using the <F2> BIOS Setup Utility, accessed during system POST, options are available to enable/disable SW RAID, and select which embedded software RAID option to use.

### 3.3.23.1 Intel® Embedded Server RAID Technology 2 (ESRT2)

Features of the embedded software RAID option Intel® Embedded Server RAID Technology 2 (ESRT2) include the following:

- Based on LSI\* MegaRAID Software Stack
- Software RAID with system providing memory and CPU utilization
- Supported RAID Levels – 0,1,5,10
  - 4 & 8 Port SATA RAID 5 support provided with appropriate Intel® RAID C600 Upgrade Key
  - 4 & 8 Port SAS RAID 5 support provided with appropriate Intel® RAID C600 Upgrade Key
- Maximum drive support = Eight (with or without SAS expander option installed)
- Open Source Compliance = Binary Driver (includes Partial Source files) or Open Source using MDRAID layer in Linux\*.
- OS Support = Windows 7\*, Windows 2008\*, Windows 2003\*, RHEL\*, SLES\*, other Linux\* variants using partial source builds.
- Utilities = Windows\* GUI and CLI, Linux\* GUI and CLI, DOS CLI, and EFI CLI

### 3.3.23.2 Intel® Rapid Storage Technology (RSTe)

Features of the embedded software RAID option Intel® Rapid Storage Technology (RSTe) include the following:

- Software RAID with system providing memory and CPU utilization
  - Supported RAID Levels – 0,1,5,10
    - 4 Port SATA RAID 5 available standard (no option key required)
    - 8 Port SATA RAID 5 support provided with appropriate Intel® RAID C600 Upgrade Key
    - No SAS RAID 5 support
  - Maximum drive support = 32 (in arrays with 8 port SAS), 16 (in arrays with 4 port SAS), 128 (JBOD)
  - Open Source Compliance = Yes (uses MDRAID)
  - OS Support = Windows 7\*, Windows 2008\*, Windows 2003\*, RHEL\* 6.2 and later, SLES\* 11 w/SP2 and later, VMWare\* 5.x.
  - Utilities = Windows\* GUI and CLI, Linux\* CLI, DOS CLI, and EFI CLI
  - Uses Matrix Storage Manager for Windows\*
  - MDRAID supported in Linux\* (does not require a driver)
- Note:** No boot drive support to targets attached through SAS expander card

### 3.4 Integrated Baseboard Management Controller (BMC) Overview

The server board utilizes the I/O controller, Graphics Controller, and Baseboard Management features of the Server Engines\* Pilot-III Server Management Controller. The following is an overview of the features as implemented on the server board from each embedded controller.

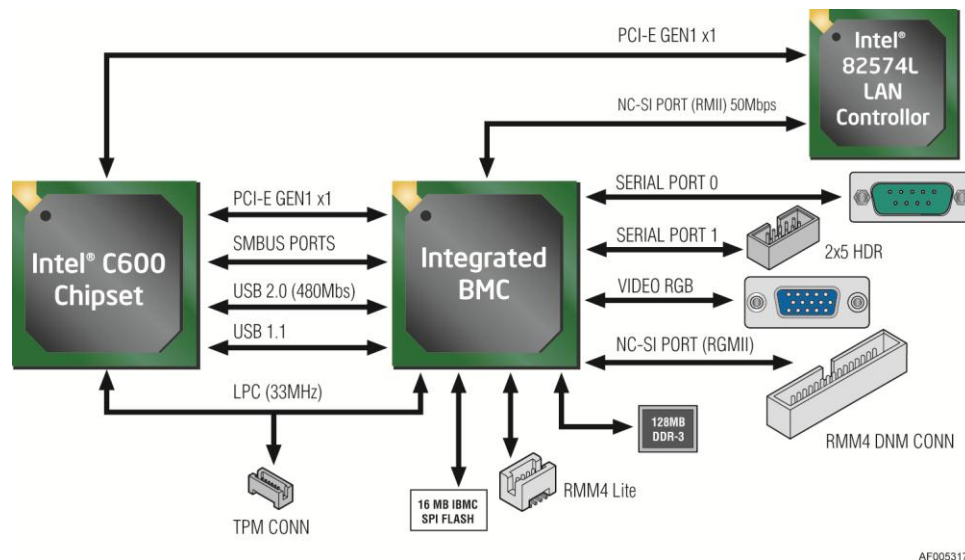

Figure 17. Integrated Baseboard Management Controller (BMC) Overview

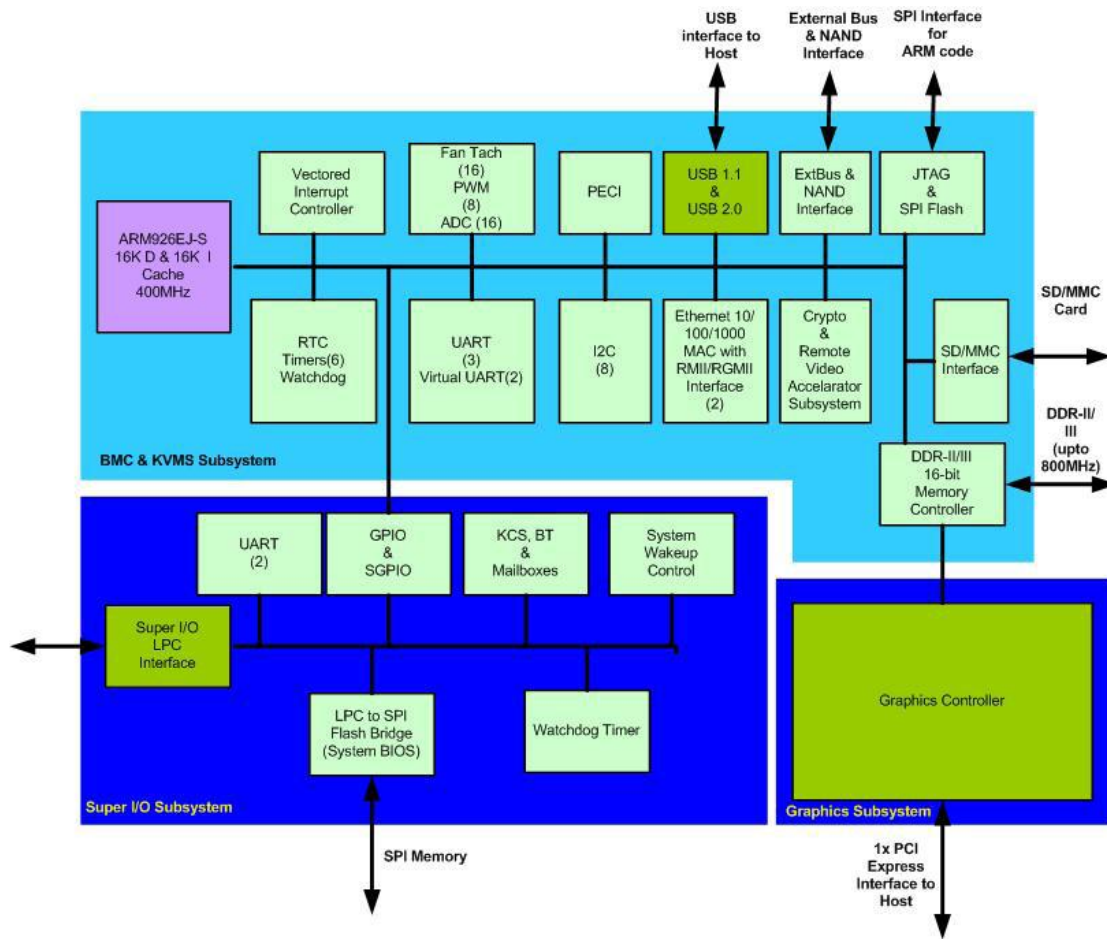

Figure 18. Integrated BMC Hardware

### 3.4.1 Super I/O Controller

The integrated super I/O controller provides support for the following features as implemented on the server board:

- Two Fully Functional Serial Ports, compatible with the 16C550
- Serial IRQ Support
- Up to 16 Shared direct GPIO's
- Serial GPIO support for 80 general purpose inputs and 80 general purpose outputs available for host processor
- Programmable Wake-up Event Support
- Plug and Play Register Set
- Power Supply Control
- Host SPI bridge for system BIOS support

### 3.4.1.1 Keyboard and Mouse Support

The server board does not support PS/2 interface keyboards and mice. However, the system BIOS recognizes USB specification-compliant keyboard and mice.

### 3.4.1.2 Wake-up Control

The super I/O contains functionality that allows various events to power on and power off the system.

## 3.4.2 Graphics Controller and Video Support

The integrated graphics controller provides support for the following features as implemented on the server board:

- Integrated Graphics Core with 2D Hardware accelerator
- DDR-3 memory interface supporting up to 128MB of memory, 16MB allocated to graphic
- Supports display resolutions up to 1600 x 1200 16bpp @ 60Hz
- High speed Integrated 24-bit RAMDAC
- Single lane PCI-Express host interface running at Gen 1 speed

The integrated video controller supports all standard IBM VGA modes. The following table shows the 2D modes supported for both CRT and LCD:

**Table 9. Video Modes**

2D Mode	2D Video Mode Support			
	8 bpp	16 bpp	24 bpp	32 bpp
640x480	X	X	X	X
800x600	X	X	X	X
1024x768	X	X	X	X
1152x864	X	X	X	X
1280x1024	X	X	X	X
1600x1200**	X	X		

\*\* Video resolutions at 1600x1200 and higher are only supported through the external video connector located on the rear I/O section of the server board. Utilizing the optional front panel video connector may result in lower video resolutions.

The server board provides two video interfaces. The primary video interface is accessed using a standard 15-pin VGA connector found on the back edge of the server board. In addition, video signals are routed to a 14-pin header labeled “FP\_Video” on the leading edge of the server board, allowing for the option of cabling to a front panel video connector. Attaching a monitor to the front panel video connector will disable the primary external video connector on the back edge of the board.

The BIOS supports dual-video mode when an add-in video card is installed.

- In the single mode (dual monitor video = disabled), the on-board video controller is disabled when an add-in video card is detected.

- In the dual mode (on-board video = enabled, dual monitor video = enabled), the on-board video controller is enabled and is the primary video device. The add-in video card is allocated resources and is considered the secondary video device. The BIOS Setup utility provides options to configure the feature as follows:

**Table 10. Video mode**

On-board Video	Enabled Disabled	
Dual Monitor Video	Enabled Disabled	Shaded if on-board video is set to "Disabled"

### 3.4.3 Baseboard Management Controller

The server board utilizes the following features of the embedded baseboard management controller.

- IPMI 2.0 Compliant
- 400MHz 32-bit ARM9 processor with memory management unit (MMU)
- Two independent 10/100/1000 Ethernet Controllers with RMII/RGMII support
- DDR2/3 16-bit interface with up to 800 MHz operation
- 12 10-bit ADCs
- Fourteen fan tachometers
- Eight Pulse Width Modulators (PWM)
- Chassis intrusion logic
- JTAG Master
- Eight I2C interfaces with master-slave and SMBus\* timeout support. All interfaces are SMBus\* 2.0 compliant.
- Parallel general-purpose I/O Ports (16 direct, 32 shared)
- Serial general-purpose I/O Ports (80 in and 80 out)
- Three UARTs
- Platform Environmental Control Interface (PECI)
- Six general-purpose timers
- Interrupt controller
- Multiple SPI flash interfaces
- NAND/Memory interface
- Sixteen mailbox registers for communication between the BMC and host
- LPC ROM interface
- BMC watchdog timer capability
- SD/MMC card controller with DMA support
- LED support with programmable blink rate controls on GPIOs
- Port 80h snooping capability
- Secondary Service Processor (SSP), which provides the HW capability of offloading time critical processing tasks from the main ARM core.

### 3.4.3.1 Remote Keyboard, Video, Mouse, and Storage (KVM) Support

- USB 2.0 interface for Keyboard, Mouse and Remote storage such as CD/DVD ROM and floppy
- USB 1.1/USB 2.0 interface for PS2 to USB bridging, remote Keyboard and Mouse
- Hardware Based Video Compression and Redirection Logic
- Supports both text and Graphics redirection
- Hardware assisted Video redirection using the Frame Processing Engine
- Direct interface to the Integrated Graphics Controller registers and Frame buffer
- Hardware-based encryption engine

### 3.4.3.2 Integrated BMC Embedded LAN Channel

The Integrated BMC hardware includes two dedicated 10/100 network interfaces. These interfaces are not shared with the host system. At any time, only one dedicated interface may be enabled for management traffic. The default active interface is the NIC 1 port.

For these channels, support can be enabled for IPMI-over-LAN and DHCP. For security reasons, embedded LAN channels have the following default settings:

- IP Address: Static.
- All users disabled.

## 4. System Security

---

### 4.1 BIOS Password Protection

The BIOS uses passwords to prevent unauthorized tampering with the server setup. Passwords can restrict entry to the BIOS Setup, restrict use of the Boot Popup menu, and suppress automatic USB device reordering.

There is also an option to require a Power On password entry in order to boot the system. If the Power On Password function is enabled in Setup, the BIOS will halt early in POST to request a password before continuing POST.

Both Administrator and User passwords are supported by the BIOS. An Administrator password must be installed in order to set the User password. The maximum length of a password is 14 characters. A password can have alphanumeric (a-z, A-Z, 0-9) characters and it is case sensitive. Certain special characters are also allowed, from the following set:

! @ # \$ % ^ & \* ( ) - \_ + = ?

The Administrator and User passwords must be different from each other. An error message will be displayed if there is an attempt to enter the same password for one as for the other.

The use of “Strong Passwords” is encouraged, but not required. In order to meet the criteria for a “Strong Password”, the password entered must be at least 8 characters in length, and must include at least one each of alphabetic, numeric, and special characters. If a “weak” password is entered, a popup warning message will be displayed, although the weak password will be accepted.

Once set, a password can be cleared by changing it to a null string. This requires the Administrator password, and must be done through BIOS Setup or other explicit means of changing the passwords. Clearing the Administrator password will also clear the User password.

Alternatively, the passwords can be cleared by using the Password Clear jumper if necessary. Resetting the BIOS configuration settings to default values (by any method) has no effect on the Administrator and User passwords.

Entering the User password allows the user to modify only the System Time and System Date in the Setup Main screen. Other setup fields can be modified only if the Administrator password has been entered. If any password is set, a password is required to enter the BIOS setup.

The Administrator has control over all fields in the BIOS setup, including the ability to clear the User password and the Administrator password.

It is strongly recommended that at least an Administrator Password be set, since not having set a password gives everyone who boots the system the equivalent of Administrative access. Unless an Administrator password is installed, any User can go into Setup and change BIOS settings at will.



In addition to restricting access to most Setup fields to viewing only when a User password is entered, defining a User password imposes restrictions on booting the system. In order to simply boot in the defined boot order, no password is required. However, the F6 Boot popup prompts for a password, and can only be used with the Administrator password. Also, when a User password is defined, it suppresses the USB Reordering that occurs, if enabled, when a new USB boot device is attached to the system. A User is restricted from booting in anything other than the Boot Order defined in the Setup by an Administrator.

As a security measure, if a User or Administrator enters an incorrect password three times in a row during the boot sequence, the system is placed into a halt state. A system reset is required to exit out of the halt state. This feature makes it more difficult to guess or break a password.

In addition, on the next successful reboot, the Error Manager displays a Major Error code 0048, which also logs a SEL event to alert the authorized user or administrator that a password access failure has occurred

## 4.2 Trusted Platform Module (TPM) Support

Trusted Platform Module (TPM) option is a hardware-based security device that addresses the growing concern on boot process integrity and offers better data protection. TPM protects the system start-up process by ensuring it is tamper-free before releasing system control to the operating system. A TPM device provides secured storage to store data, such as security keys and passwords. In addition, a TPM device has encryption and hash functions. The server board implements TPM as per *TPM PC Client Specifications*, revision 1.2, by the Trusted Computing Group (TCG).

A TPM device is optionally installed onto a high density 14-pin connector labeled “TPM” and is secured from external software attacks and physical theft. A pre-boot environment, such as the BIOS and operating system loader, uses the TPM to collect and store unique measurements from multiple factors within the boot process to create a system fingerprint. This unique fingerprint remains the same unless the pre-boot environment is tampered with. Therefore, it is used to compare to future measurements to verify the integrity of the boot process.

After the system BIOS completes the measurement of its boot process, it hands off control to the operating system loader and in turn to the operating system. If the operating system is TPM-enabled, it compares the BIOS TPM measurements to those of previous boots to make sure the system was not tampered with before continuing the operating system boot process. Once the operating system is in operation, it optionally uses TPM to provide additional system and data security (for example, Microsoft Vista\* supports BitLocker drive encryption).

### 4.2.1 TPM security BIOS

The BIOS TPM support conforms to the *TPM PC Client Specific – Implementation Specification* for Conventional BIOS, version 1.2, and to the *TPM Interface Specification*, version 1.2. The BIOS adheres to the Microsoft Vista\* BitLocker requirement. The role of the BIOS for TPM security includes the following:

- Measures and stores the boot process in the TPM microcontroller to allow a TPM enabled operating system to verify system boot integrity.

- Produces EFI and legacy interfaces to a TPM-enabled operating system for using TPM.
- Produces ACPI TPM device and methods to allow a TPM-enabled operating system to send TPM administrative command requests to the BIOS.
- Verifies operator physical presence. Confirms and executes operating system TPM administrative command requests.
- Provides BIOS Setup options to change TPM security states and to clear TPM ownership.

For additional details, refer to the *TCG PC Client Specific Implementation Specification*, the *TCG PC Client Specific Physical Presence Interface Specification*, and the *Microsoft BitLocker\* Requirement* documents.

## 4.2.2 Physical Presence

Administrative operations to the TPM require TPM ownership or physical presence indication by the operator to confirm the execution of administrative operations. The BIOS implements the operator presence indication by verifying the setup Administrator password.

A TPM administrative sequence invoked from the operating system proceeds as follows:

1. User makes a TPM administrative request through the operating system's security software.
2. The operating system requests the BIOS to execute the TPM administrative command through TPM ACPI methods and then resets the system.
3. The BIOS verifies the physical presence and confirms the command with the operator.
4. The BIOS executes TPM administrative command(s), inhibits BIOS Setup entry and boots directly to the operating system which requested the TPM command(s).

## 4.2.3 TPM Security Setup Options

The BIOS TPM Setup allows the operator to view the current TPM state and to carry out rudimentary TPM administrative operations. Performing TPM administrative options through the BIOS setup requires TPM physical presence verification.

Using BIOS TPM Setup, the operator can turn ON or OFF TPM functionality and clear the TPM ownership contents. After the requested TPM BIOS Setup operation is carried out, the option reverts to No Operation.

The BIOS TPM Setup also displays the current state of the TPM, whether TPM is enabled or disabled and activated or deactivated. Note that while using TPM, a TPM-enabled operating system or application may change the TPM state independent of the BIOS setup. When an operating system modifies the TPM state, the BIOS Setup displays the updated TPM state.

The BIOS Setup TPM Clear option allows the operator to clear the TPM ownership key and allows the operator to take control of the system with TPM. You use this option to clear security settings for a newly initialized system or to clear a system for which the TPM ownership security key was lost.

### 4.2.3.1 Security Screen

To enter the BIOS Setup, press the F2 function key during boot time when the OEM or Intel logo displays. The following message displays on the diagnostics screen and under the Quiet Boot logo screen:

Press <F2> to enter setup

When the Setup is entered, the Main screen displays. The BIOS Setup utility provides the Security screen to enable and set the user and administrative passwords and to lock out the front panel buttons so they cannot be used. The Intel® Server Board S5520URT provides TPM settings through the security screen.

To access this screen from the Main screen, select the **Security** option.

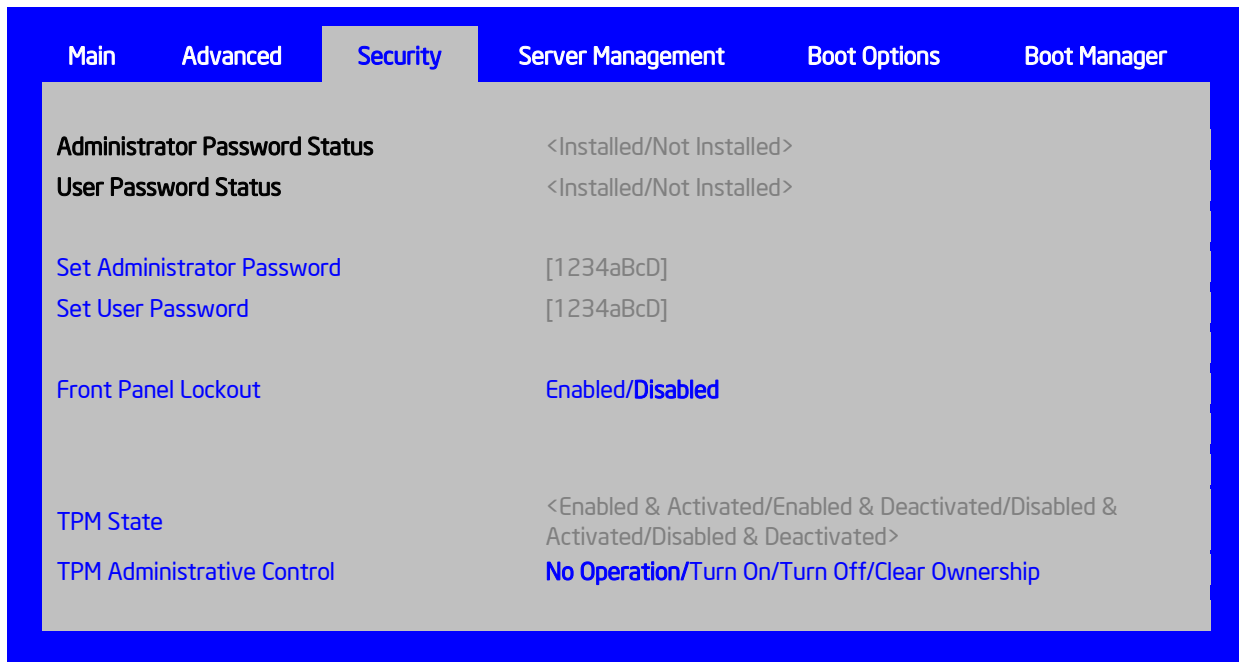

Figure 19. Setup Utility – TPM Configuration Screen

**Table 11. TPM Setup Utility – Security Configuration Screen Fields**

Setup Item	Options	Help Text	Comments
TPM State*	Enabled and Activated Enabled and Deactivated Disabled and Activated Disabled and Deactivated		Information only. Shows the current TPM device state.  A disabled TPM device will not execute commands that use TPM functions and TPM security operations will not be available.  An enabled and deactivated TPM is in the same state as a disabled TPM except setting of TPM ownership is allowed if not present already.  An enabled and activated TPM executes all commands that use TPM functions and TPM security operations will be available.
TPM Administrative Control**	<b>No Operation</b> Turn On Turn Off Clear Ownership	[No Operation] - No changes to current state. [Turn On] - Enables and activates TPM. [Turn Off] - Disables and deactivates TPM. [Clear Ownership] - Removes the TPM ownership authentication and returns the TPM to a factory default state. <b>Note:</b> The BIOS setting returns to [No Operation] on every boot cycle by default.	

### 4.3 Intel® Trusted Execution Technology

The Intel® Xeon® Processor E5-4600/2600/2400/1600 Product Families support Intel® Trusted Execution Technology (Intel® TXT), which is a robust security environment. Designed to help protect against software-based attacks, Intel® Trusted Execution Technology integrates new security features and capabilities into the processor, chipset and other platform components. When used in conjunction with Intel® Virtualization Technology, Intel® Trusted Execution Technology provides hardware-rooted trust for your virtual applications.

This hardware-rooted security provides a general-purpose, safer computing environment capable of running a wide variety of operating systems and applications to increase the confidentiality and integrity of sensitive information without compromising the usability of the platform.

Intel® Trusted Execution Technology requires a computer system with Intel® Virtualization Technology enabled (both VT-x and VT-d), an Intel® Trusted Execution Technology-enabled processor, chipset and BIOS, Authenticated Code Modules, and an Intel® Trusted Execution Technology compatible measured launched environment (MLE). The MLE could consist of a

virtual machine monitor, an OS or an application. In addition, Intel® Trusted Execution Technology requires the system to include a TPM v1.2, as defined by the *Trusted Computing Group TPM PC Client Specification*, Revision 1.2.

When available, Intel Trusted Execution Technology can be enabled or disabled in the processor through a BIOS Setup option.

For general information about Intel® TXT, visit the Intel® Trusted Execution Technology website, <http://www.intel.com/technology/security/>.

## 5. Technology Support

---

### 5.1 Intel® Trusted Execution Technology

The Intel® Xeon® Processor E5 4600/2600/2400/1600 Product Families support Intel® Trusted Execution Technology (Intel® TXT), which is a robust security environment designed to help protect against software-based attacks. Intel® Trusted Execution Technology integrates new security features and capabilities into the processor, chipset and other platform components. When used in conjunction with Intel® Virtualization Technology and Intel® VT for Directed IO, with an active TPM, Intel® Trusted Execution Technology provides hardware-rooted trust for your virtual applications.

### 5.2 Intel® Virtualization Technology – Intel® VT-x/VT-d/VT-c

Intel® Virtualization Technology consists of three components which are integrated and interrelated, but which address different areas of Virtualization.

- Intel® Virtualization Technology (**VT-x**) is processor-related and provides capabilities needed to provide hardware assist to a Virtual Machine Monitor (VMM).
- Intel® Virtualization Technology for Directed I/O (**VT-d**) is primarily concerned with virtualizing I/O efficiently in a VMM environment. This would generally be a chipset I/O feature, but in the Second Generation Intel® Core™ Processor Family there is an Integrated I/O unit embedded in the processor, and the IIO is also enabled for VT-d.
- Intel® Virtualization Technology for Connectivity (**VT-c**) is primarily concerned I/O hardware assist features, complementary to but independent of VT-d.

Intel® VT-x is designed to support multiple software environments sharing same hardware resources. Each software environment may consist of OS and applications. The Intel® Virtualization Technology features can be enabled or disabled in the BIOS setup. The default behavior is disabled.

Intel® VT-d is supported jointly by the Intel® Xeon® Processor E5 4600/2600/2400/1600 Product Families and the C600 chipset. Both support DMA remapping from inbound PCI Express\* memory Guest Physical Address (GPA) to Host Physical Address (HPA). PCI devices are directly assigned to a virtual machine leading to a robust and efficient virtualization.

The Intel® S4600/S2600/S2400/S1600/S1400 Server Board Family BIOS publishes the DMAR table in the ACPI Tables. For each DMA Remapping Engine in the platform, one exact entry of DRHD (DMA Remapping Hardware Unit Definition) structure is added to the DMAR. The DRHD structure in turn contains a Device Scope structure that describes the PCI endpoints and/or sub-hierarchies handled by the particular DMA Remapping Engine.

Similarly, there are reserved memory regions typically allocated by the BIOS at boot time. The BIOS marks these regions as either reserved or unavailable in the system address memory map reported to the OS. Some of these regions can be a target of DMA requests from one or more devices in the system, while the OS or executive is active. The BIOS reports each such memory region using exactly one RMRR (Reserved Memory Region Reporting) structure in the DMAR. Each RMRR has a Device Scope listing the devices in the system that can cause a DMA request to the region.

For more information on the DMAR table and the DRHD entry format, refer to the *Intel® Virtualization Technology for Directed I/O Architecture Specification*. For more general

information about VT-x, VT-d, and VT-c, a good reference is *Enabling Intel® Virtualization Technology Features and Benefits White Paper*.

### 5.3 Intel® Intelligent Power Node Manager

Data centers are faced with power and cooling challenges that are driven by increasing numbers of servers deployed and server density in the face of several data center power and cooling constraints. In this type of environment, Information Technology (IT) needs the ability to monitor actual platform power consumption and control power allocation to servers and racks in order to solve specific data center problems including the following issues.

**Table 12. Intel® Intelligent Power Node Manager**

IT Challenge	Requirement
Over-allocation of power	<ul style="list-style-type: none"> <li>▪ Ability to monitor actual power consumption</li> <li>▪ Control capability that can maintain a power budget to enable dynamic power allocation to each server</li> </ul>
Under-population of rack space	<ul style="list-style-type: none"> <li>▪ Control capability that can maintain a power budget to enable increased rack population.</li> </ul>
High energy costs	<ul style="list-style-type: none"> <li>▪ Control capability that can maintain a power budget to ensure that a set energy cost can be achieved</li> </ul>
Capacity planning	<ul style="list-style-type: none"> <li>▪ Ability to monitor actual power consumption to enable power usage modeling over time and a given planning period</li> <li>▪ Ability to understand cooling demand from a temperature and airflow perspective</li> </ul>
Detection and correction of hot spots	<ul style="list-style-type: none"> <li>▪ Control capability that reduces platform power consumption to protect a server in a hot-spot</li> <li>▪ Ability to monitor server inlet temperatures to enable greater rack utilization in areas with adequate cooling.</li> </ul>

The requirements listed above are those that are addressed by the C600 chipset Management Engine (ME) and Intel® Intelligent Power Node Manager (NM) technology. The ME/NM combination is a power and thermal control capability on the platform, which exposes external interfaces that allow IT (through external management software) to query the ME about platform power capability and consumption, thermal characteristics, and specify policy directives (for example, set a platform power budget).

Node Manager (NM) is a platform resident technology that enforces power capping and thermal-triggered power capping policies for the platform. These policies are applied by exploiting subsystem knobs (such as processor P and T states) that can be used to control power consumption. NM enables data center power management by exposing an external interface to management software through which platform policies can be specified. It also implements specific data center power management usage models such as power limiting, and thermal monitoring.

The NM feature is implemented by a complementary architecture utilizing the ME, BMC, BIOS, and an ACPI-compliant OS. The ME provides the NM policy engine and power control/limiting functions (referred to as Node Manager or NM) while the BMC provides the external LAN link by which external management software can interact with the feature. The BIOS provides system power information utilized by the NM algorithms and also exports ACPI Source Language (ASL) code used by OS-Directed Power Management (OSPM) for negotiating processor P and T state

changes for power limiting. PMBus\*-compliant power supplies provide the capability to monitoring input power consumption, which is necessary to support NM.

Below are the some of the applications of Intel® Intelligent Power Node Manager technology.

- **Platform Power Monitoring and Limiting:** The ME/NM monitors platform power consumption and hold average power over duration. It can be queried to return actual power at any given instance. The power limiting capability is to allow external management software to address key IT issues by setting a power budget for each server. For example, if there is a physical limit on the power available in a room, then IT can decide to allocate power to different servers based on their usage – servers running critical systems can be allowed more power than servers that are running less critical workload.
- **Inlet Air Temperature Monitoring:** The ME/NM monitors server inlet air temperatures periodically. If there is an alert threshold in effect, then ME/NM issues an alert when the inlet (room) temperature exceeds the specified value. The threshold value can be set by policy.
- **Memory Subsystem Power Limiting:** The ME/NM monitors memory power consumption. Memory power consumption is estimated using average bandwidth utilization information
- **Processor Power monitoring and limiting:** The ME/NM monitors processor or socket power consumption and holds average power over duration. It can be queried to return actual power at any given instant. The monitoring process of the ME will be used to limit the processor power consumption through processor P-states and dynamic core allocation
- **Core allocation at boot time:** Restrict the number of cores for OS/VMM use by limiting how many cores are active at boot time. After the cores are turned off, the CPU will limit how many working cores are visible to BIOS and OS/VMM. The cores that are turned off cannot be turned on dynamically after the OS has started. It can be changed only at the next system reboot.
- **Core allocation at run-time:** This particular use case provides a higher level processor power control mechanism to a user at run-time, after booting. An external agent can dynamically use or not use cores in the processor subsystem by requesting ME/NM to control them, specifying the number of cores to use or not use.

### 5.3.1 Hardware Requirements

NM is supported only on platforms that have the NM FW functionality loaded and enabled on the Management Engine (ME) in the SSB and that have a BMC present to support the external LAN interface to the ME. NM power limiting features requires a means for the ME to monitor input power consumption for the platform. This capability is generally provided by means of PMBus\*-compliant power supplies although an alternative model using a simpler SMBus\* power monitoring device is possible (there is potential loss in accuracy and responsiveness using non-PMBus\* devices). The NM SmART/CLST feature does specifically require PMBus\*-compliant power supplies as well as additional hardware on the baseboard.



## 6. Platform Management Functional Overview

---

Platform management functionality is supported by several hardware and software components integrated on the server board that work together to control system functions, monitor and report system health, and control various thermal and performance features in order to maintain (when possible) server functionality in the event of component failure and/or environmentally stressed conditions.

This chapter provides a high level overview of the platform management features and functionality implemented on the server board. For more in depth and design level Platform Management information, please reference the *BMC Core Firmware External Product Specification (EPS)* and *BIOS Core External Product Specification (EPS)* for Intel® Server products based on the Intel® Xeon® processor E5-2400 product families.

### 6.1 Baseboard Management Controller (BMC) Firmware Feature Support

The following sections outline features that the integrated BMC firmware can support. Support and utilization for some features is dependent on the server platform in which the server board is integrated and any additional system level components and options that may be installed.

#### 6.1.1 IPMI 2.0 Features

- Baseboard management controller (BMC)
- IPMI Watchdog timer
- Messaging support, including command bridging and user/session support
- Chassis device functionality, including power/reset control and BIOS boot flags support
- Event receiver device: The BMC receives and processes events from other platform subsystems.
- Field Replaceable Unit (FRU) inventory device functionality: The BMC supports access to system FRU devices using IPMI FRU commands.
- System Event Log (SEL) device functionality: The BMC supports and provides access to a SEL.
- Sensor Data Record (SDR) repository device functionality: The BMC supports storage and access of system SDRs.
- Sensor device and sensor scanning/monitoring: The BMC provides IPMI management of sensors. It polls sensors to monitor and report system health.
- IPMI interfaces
  - Host interfaces include system management software (SMS) with receive message queue support, and server management mode (SMM)
  - IPMB interface
  - LAN interface that supports the IPMI-over-LAN protocol (RMCP, RMCP+)
- Serial-over-LAN (SOL)
- ACPI state synchronization: The BMC tracks ACPI state changes that are provided by the BIOS.
- BMC self test: The BMC performs initialization and run-time self-tests and makes results available to external entities.

See also the *Intelligent Platform Management Interface Specification Second Generation v2.0*.

## Non IPMI Features

The BMC supports the following non-IPMI features.

- In-circuit BMC firmware update
- BMC FW reliability enhancements:
  - Redundant BMC boot blocks to avoid possibility of a corrupted boot block resulting in a scenario that prevents a user from updating the BMC.
  - BMC System Management Health Monitoring
- Fault resilient booting (FRB): FRB2 is supported by the watchdog timer functionality.
- Enable/Disable of System Reset Due CPU Errors
- Chassis intrusion detection
- Fan speed control
- Fan redundancy monitoring and support
- Hot-swap fan support
- Power Supply Fan Sensors
- System Airflow Monitoring
- Exit Air Temperature Monitoring
- Acoustic management: Support for multiple fan profiles
- Ethernet Controller Thermal Monitoring
- Global Aggregate Temperature Margin Sensor
- Platform environment control interface (PECI) thermal management support
- Memory Thermal Management
- DIMM temperature monitoring: New sensors and improved acoustic management using closed-loop fan control algorithm taking into account DIMM temperature readings.
- Power supply redundancy monitoring and support
- Power unit management: Support for power unit sensor. The BMC handles power-good dropout conditions.
- Intel® Intelligent Power Node Manager support
- Signal testing support: The BMC provides test commands for setting and getting platform signal states.
- The BMC generates diagnostic beep codes for fault conditions.
- System GUID storage and retrieval
- Front panel management: The BMC controls the system status LED and chassis ID LED. It supports secure lockout of certain front panel functionality and monitors button presses. The chassis ID LED is turned on using a front panel button or a command.
- Local Control Display Panel support
- Power state retention
- Power fault analysis
- Intel® Light-Guided Diagnostics

- Address Resolution Protocol (ARP): The BMC sends and responds to ARPs (supported on embedded NICs).
- Dynamic Host Configuration Protocol (DHCP): The BMC performs DHCP (supported on embedded NICs).
- E-mail alerting
- Embedded web server
  - Support for embedded web server UI in Basic Manageability feature set.
  - Human-readable SEL
  - Additional system configurability
  - Additional system monitoring capability
  - Enhanced on-line help
- Integrated KVM
- Integrated Remote Media Redirection
- Local Directory Access Protocol (LDAP) support
- Sensor and SEL logging additions/enhancements (for example, additional thermal monitoring capability)
- SEL Severity Tracking and the Extended SEL
- Embedded platform debug feature which allows capture of detailed data for later analysis.
- Provisioning and inventory enhancements:
  - Inventory data/system information export (partial SMBIOS table)
- DCMI 1.1 compliance (product-specific).
- Management support for PMBus\* rev1.2 compliant power supplies
- Energy Star Server Support
- Smart Ride Through (SmaRT)/Closed Loop System Throttling (CLST)
- Power Supply Cold Redundancy
- Power Supply FW Update
- Power Supply Compatibility Check

### 6.1.2 New Manageability Features

Intel® S1400/S1600/S2400/S2600 Server Platforms offer a number of changes and additions to the manageability features that are supported on the previous generation of servers. The following is a list of the more significant changes that are common to this generation Integrated BMC based Intel® Server boards:

- Sensor and SEL logging additions/enhancements (for example, additional thermal monitoring capability)
- SEL Severity Tracking and the Extended SEL
- Embedded platform debug feature which allows capture of detailed data for later analysis.
- Provisioning and inventory enhancements:
  - Inventory data/system information export (partial SMBIOS table)
- Enhancements to fan speed control.

- DCMI 1.1 compliance (product-specific).
- Support for embedded web server UI in Basic Manageability feature set.
- Enhancements to embedded web server
  - Human-readable SEL
  - Additional system configurability
  - Additional system monitoring capability
  - Enhanced on-line help
- Enhancements to KVM redirection
  - Support for higher resolution
- Support for EU Lot6 compliance
- Management support for PMBus\* rev1.2 compliant power supplies
- BMC Data Repository (Managed Data Region Feature)
- Local Control Display Panel
- System Airflow Monitoring
- Exit Air Temperature Monitoring
- Ethernet Controller Thermal Monitoring
- Global Aggregate Temperature Margin Sensor
- Memory Thermal Management
- Power Supply Fan Sensors
- Energy Star Server Support
- Smart Ride Through (SmaRT)/ Closed Loop System Throttling (CLST)
- Power Supply Cold Redundancy
- Power Supply FW Update
- Power Supply Compatibility Check
- BMC FW reliability enhancements:
  - Redundant BMC boot blocks to avoid possibility of a corrupted boot block resulting in a scenario that prevents a user from updating the BMC.
  - BMC System Management Health Monitoring

## 6.2 Basic and Advanced Features

The following table lists basic and advanced feature support. Individual features may vary by platform. See the appropriate Platform Specific EPS addendum for more information.

**Table 13. Basic and Advanced Features**

Feature	Basic	Advanced
IPMI 2.0 Feature Support	X	X
In-circuit BMC Firmware Update	X	X
FRB 2	X	X
Chassis Intrusion Detection	X	X
Fan Redundancy Monitoring	X	X
Hot-Swap Fan Support	X	X
Acoustic Management	X	X

Feature	Basic	Advanced
Diagnostic Beep Code Support	X	X
Power State Retention	X	X
ARP/DHCP Support	X	X
PECI Thermal Management Support	X	X
E-mail Alerting	X	X
Embedded Web Server	X	X
SSH Support	X	X
Integrated KVM		X
Integrated Remote Media Redirection		X
Lightweight Directory Access Protocol (LDAP)	X	X
Intel® Intelligent Power Node Manager Support	X	X
SMASH CLP	X	X

## 6.3 Integrated BMC Hardware: Emulex\* Pilot III

### 6.3.1 Emulex\* Pilot III Baseboard Management Controller Functionality

The Integrated BMC is provided by an embedded ARM9 controller and associated peripheral functionality that is required for IPMI-based server management. Firmware usage of these hardware features is platform dependent.

The following is a summary of the Integrated BMC management hardware features that comprise the BMC:

- 400MHz 32-bit ARM9 processor with memory management unit (MMU)
- Two independent 10/100/1000 Ethernet Controllers with Reduced Media Independent Interface (RMII)/ Reduced Gigabit Media Independent Interface (RGMII) support
- DDR2/3 16-bit interface with up to 800 MHz operation
- 16 10-bit ADCs
- Sixteen fan tachometers
- Eight Pulse Width Modulators (PWM)
- Chassis intrusion logic
- JTAG Master
- Eight I<sup>2</sup>C interfaces with master-slave and SMBus\* timeout support. All interfaces are SMBus\* 2.0 compliant.
- Parallel general-purpose I/O Ports (16 direct, 32 shared)
- Serial general-purpose I/O Ports (80 in and 80 out)
- Three UARTs
- Platform Environmental Control Interface (PECI)
- Six general-purpose timers
- Interrupt controller
- Multiple Serial Peripheral Interface (SPI) flash interfaces
- NAND/Memory interface
- Sixteen mailbox registers for communication between the BMC and host
- LPC ROM interface
- BMC watchdog timer capability
- SD/MMC card controller with DMA support
- LED support with programmable blink rate controls on GPIOs
- Port 80h snooping capability

- Secondary Service Processor (SSP), which provides the HW capability of offloading time critical processing tasks from the main ARM core.

Emulex\* Pilot III contains an integrated SIO, KVMs subsystem and graphics controller with the following features:

## 6.4 Advanced Configuration and Power Interface (ACPI)

The server board has support for the following ACPI states:

**Table 14. ACPI Power States**

State	Supported	Description
S0	Yes	Working. <ul style="list-style-type: none"> <li>▪ The front panel power LED is on (not controlled by the BMC).</li> <li>▪ The fans spin at the normal speed, as determined by sensor inputs.</li> <li>▪ Front panel buttons work normally.</li> </ul>
S1	Yes	Sleeping. Hardware context is maintained; equates to processor and chipset clocks being stopped. <ul style="list-style-type: none"> <li>▪ The front panel power LED blinks at a rate of 1 Hz with a 50% duty cycle (not controlled by the BMC).</li> <li>▪ The watchdog timer is stopped.</li> <li>▪ The power, reset, front panel NMI, and ID buttons are unprotected.</li> <li>▪ Fan speed control is determined by available SDRs. Fans may be set to a fixed state, or basic fan management can be applied.</li> </ul> The BMC detects that the system has exited the ACPI S1 sleep state when the BIOS SMI handler notifies it.
S2	No	Not supported.
S3	No	Supported only on Workstation platforms. See appropriate Platform Specific Information for more information.
S4	No	Not supported.
S5	Yes	Soft off. <ul style="list-style-type: none"> <li>▪ The front panel buttons are not locked.</li> <li>▪ The fans are stopped.</li> <li>▪ The power-up process goes through the normal boot process.</li> <li>▪ The power, reset, front panel NMI, and ID buttons are unlocked.</li> </ul>

## 6.5 Power Control Sources

The server board supports several power control sources which can initiate a power-up or power-down activity.

**Table 15. Power Control Initiators**

Source	External Signal Name or Internal Subsystem	Capabilities
Power button	Front panel power button	Turns power on or off
BMC watchdog timer	Internal BMC timer	Turns power off, or power cycle
Command	Routed through command processor	Turns power on or off, or power cycle

Source	External Signal Name or Internal Subsystem	Capabilities
Power state retention	Implemented by means of BMC internal logic	Turns power on when AC power returns
Chipset	Sleep S4/S5 signal (same as <i>POWER_ON</i> )	Turns power on or off
CPU Thermal	CPU Thermtrip	Turns power off
WOL(Wake On LAN)	LAN	Turns power on

## 6.6 BMC Watchdog

The BMC FW is increasingly called upon to perform system functions that are time-critical in that failure to provide these functions in a timely manner can result in system or component damage. Intel® S1400/S1600/S2400/S2600/S4600 Server Platforms introduce a BMC watchdog feature to provide a safe-guard against this scenario by providing an automatic recovery mechanism. It also can provide automatic recovery of functionality that has failed due to a fatal FW defect triggered by a rare sequence of events or a BMC hang due to some type of HW glitch (for example, power).

This feature is comprised of a set of capabilities whose purpose is to detect misbehaving subsections of BMC firmware, the BMC CPU itself, or HW subsystems of the BMC component, and to take appropriate action to restore proper operation. The action taken is dependent on the nature of the detected failure and may result in a restart of the BMC CPU, one or more BMC HW subsystems, or a restart of malfunctioning FW subsystems.

The BMC watchdog feature will only allow up to three resets of the BMC CPU (such as HW reset) or entire FW stack (such as a SW reset) before giving up and remaining in the uBOOT code. This count is cleared upon cycling of power to the BMC or upon continuous operation of the BMC without a watchdog-generated reset occurring for a period of > 30 minutes. The BMC FW logs a SEL event indicating that a watchdog-generated BMC reset (either soft or hard reset) has occurred. This event may be logged after the actual reset has occurred. Refer sensor section for details for the related sensor definition. The BMC will also indicate a degraded system status on the Front Panel Status LED after an BMC HW reset or FW stack reset. This state (which follows the state of the associated sensor) will be cleared upon system reset or (AC or DC) power cycle.

**Note:** A reset of the BMC may result in the following system degradations that will require a system reset or power cycle to correct:

1. Timeout value for the rotation period can be set using this parameter. Potentially, there will be incorrect ACPI Power State reported by the BMC.
2. Reversion of temporary test modes for the BMC back to normal operational modes.
3. FP status LED and DIMM fault LEDs may not reflect BIOS detected errors.

## 6.7 Fault Resilient Booting (FRB)

Fault resilient booting (FRB) is a set of BIOS and BMC algorithms and hardware support that allow a multiprocessor system to boot even if the bootstrap processor (BSP) fails. Only FRB2 is supported using watchdog timer commands.

FRB2 refers to the FRB algorithm that detects system failures during POST. The BIOS uses the BMC watchdog timer to back up its operation during POST. The BIOS configures the watchdog timer to indicate that the BIOS is using the timer for the FRB2 phase of the boot operation. After the BIOS has identified and saved the BSP information, it sets the FRB2 timer use bit and loads the watchdog timer with the new timeout interval.

If the watchdog timer expires while the watchdog use bit is set to FRB2, the BMC (if so configured) logs a watchdog expiration event showing the FRB2 timeout in the event data bytes. The BMC then hard resets the system, assuming the BIOS-selected reset as the watchdog timeout action.

The BIOS is responsible for disabling the FRB2 timeout before initiating the option ROM scan and before displaying a request for a boot password. If the processor fails and causes an FRB2 timeout, the BMC resets the system.

The BIOS gets the watchdog expiration status from the BMC. If the status shows an expired FRB2 timer, the BIOS enters the failure in the system event log (SEL). In the OEM bytes entry in the SEL, the last POST code generated during the previous boot attempt is written. FRB2 failure is not reflected in the processor status sensor value.

The FRB2 failure does not affect the front panel LEDs.

## 6.8 Sensor Monitoring

The BMC monitors system hardware and reports system health. Some of the sensors include those for monitoring

- Component, board, and platform temperatures
- Board and platform voltages
- System fan presence and tach
- Chassis intrusion
- Front Panel NMI
- Front Panel Power and System Reset Buttons
- SMI timeout
- Processor errors

The information gathered from physical sensors is translated into IPMI sensors as part of the “IPMI Sensor Model”. The BMC also reports various system state changes by maintaining virtual sensors that are not specifically tied to physical hardware.

See *Appendix B – Integrated BMC Sensor Tables for additional sensor information.*

## 6.9 Field Replaceable Unit (FRU) Inventory Device

The BMC implements the interface for logical FRU inventory devices as specified in the *Intelligent Platform Management Interface Specification, Version 2.0*. This functionality provides commands used for accessing and managing the FRU inventory information. These commands can be delivered through all interfaces.



The BMC provides FRU device command access to its own FRU device and to the FRU devices throughout the server. The FRU device ID mapping is defined in the Platform Specific Information. The BMC controls the mapping of the FRU device ID to the physical device

## 6.10 System Event Log (SEL)

The BMC implements the system event log as specified in the *Intelligent Platform Management Interface Specification, Version 2.0*. The SEL is accessible regardless of the system power state through the BMC's in-band and out-of-band interfaces.

The BMC allocates 65,502 bytes (approximately 64 KB) of non-volatile storage space to store system events. The SEL timestamps may not be in order. Up to 3,639 SEL records can be stored at a time. Any command that results in an overflow of the SEL beyond the allocated space is rejected with an "Out of Space" IPMI completion code (C4h).

Events logged to the SEL can be viewed using Intel's SELVIEW utility, Embedded Web Server, and Active System Console.

## 6.11 System Fan Management

The BMC controls and monitors the system fans. Each fan is associated with a fan speed sensor that detects fan failure and may also be associated with a fan presence sensor for hot-swap support. For redundant fan configurations, the fan failure and presence status determines the fan redundancy sensor state.

The system fans are divided into fan domains, each of which has a separate fan speed control signal and a separate configurable fan control policy. A fan domain can have a set of temperature and fan sensors associated with it. These are used to determine the current fan domain state.

A fan domain has three states: sleep, nominal, and boost. The sleep and boost states have fixed (but configurable through OEM SDRs) fan speeds associated with them. The nominal state has a variable speed determined by the fan domain policy. An OEM SDR record is used to configure the fan domain policy.

System fan speeds are controlled through pulse width modulation (PWM) signals, which are driven separately for each domain by integrated PWM hardware. Fan speed is changed by adjusting the duty cycle, which is the percentage of time the signal is driven high in each pulse

### 6.11.1 Thermal and Acoustic Management

The S2400SC offers multiple thermal and acoustic management features to maintain comprehensive thermal protection as well as intelligent fan speed control. The features can be adjusted in BIOS interface with path **BIOS > Advanced > System Acoustic and Performance Configuration**.

This feature refers to enhanced fan management to keep the system optimally cooled while reducing the amount of noise generated by the system fans. Aggressive acoustics standards might require a trade-off between fan speed and system performance parameters that contribute to the cooling requirements, primarily memory bandwidth. The BIOS, BMC, and SDRs work together to provide control over how this trade-off is determined.

This capability requires the BMC to access temperature sensors on the individual memory DIMMs. Additionally, closed-loop thermal throttling is only supported with buffered DIMMs.

### 6.11.2 Setting Throttling Mode

Select the most appropriate memory thermal throttling mechanism for memory sub-system from [Auto], [DCLTT], [SCLTT] and [SOLTT].

[Auto] – BIOS automatically detect and identify the appropriate thermal throttling mechanism based on DIMM type, airflow input, DIMM sensor availability.

[DCLTT] – Dynamic Closed Loop Thermal Throttling: for the SOD DIMM with system airflow input

[SCLTT] – Static Close Loop Thermal Throttling: for the SOD DIMM without system airflow input

[SOLTT] – Static Open Loop Thermal Throttling: for the DIMMs without sensor on DIMM (SOD)

The default setting is [Auto]

### 6.11.3 Altitude

Select the proper altitude that the system is distributed from [300m or less], [301m-900m], [901m-1500m], [Above 1500m] options. Lower altitude selection can lead to potential thermal risk. And higher altitude selection provides better cooling but with undesired acoustic and fan power consumption. If the altitude is known, higher altitude is recommended in order to provide sufficient cooling. The default setting is [301m – 900m].

### 6.11.4 Set Fan Profile

[Performance] and [Acoustic] fan profiles are available to select. The Acoustic mode offers best acoustic experience and appropriate cooling capability covering mainstream and majority of the add-in cards. Performance mode is designed to provide sufficient cooling capability covering all kinds of add-in cards on the market. The default setting is [Performance]

The [Performance] and [Acoustic] fan profiles in BIOS must be selected in [BIOS>Advanced> System Acoustic and Performance Configuration>Set Fan Profile]. The Acoustic mode offers best acoustic experience and appropriate cooling capability covering mainstream and majority of the add-in cards with 100LFM thermal requirements. For any add-in card requiring more than 100LFM , performance mode must be selected to provide sufficient cooling capability.

### 6.11.5 Fan PWM Offset

This feature is reserved for manual adjustment to the minimum fan speed curves. The valid range is from [0 to 100] which stands for 0% to 100% PWM adding to the minimum fan speed. This feature is valid when Quiet Fan Idle Mode is at Enabled state. The default setting is [0]

### 6.11.6 Quiet Fan Idle Mode

This feature can be [Enabled] or [Disabled]. If enabled, the fan will either stopped or shift to a lower speed when the aggregate sensor temperatures are satisfied indicating the system is at ideal thermal/light loading conditions. When the aggregate sensor temperatures not satisfied, the fan will shift back to normal control curves. If disabled, the fan will never stopped or shift into lower fan speed whatever the aggregate sensor temperatures are satisfied or not. The default setting is [Disabled]

**Note:**

1. The above features may or may not be in effective depends on the actual thermal characters of a specific system.
2. Refer to the Intel server system TPS for the board in Intel chassis thermal and acoustic management
3. Refer to Fan Control Whitepaper for the board in 3rd party chassis fan speed control customization.

### 6.11.7 Fan Profiles

The server system supports multiple fan control profiles to support acoustic targets and American Society of Heating, Refrigerating and Air Conditioning Engineers (ASHRAE) compliance. The BIOS Setup utility can be used to choose between meeting the target acoustic level or enhanced system performance. This is accomplished through fan profiles. The BMC supports eight fan profiles, numbered from 0 to 7.

**Table 16. Fan Profiles**

Type	Profile	Details
OLTT	0	Acoustic, 300M altitude
OLTT	1	Performance, 300M altitude
OLTT	2	Acoustic, 900M altitude
OLTT	3	Performance, 900M altitude
OLTT	4	Acoustic, 1500M altitude
OLTT	5	Performance, 1500M altitude
OLTT	6	Acoustic, 3000M altitude
OLTT	7	Performance, 3000M altitude
CLTT	0	Acoustic, 300M altitude
CLTT	1	Performance, 300M altitude
CLTT	2	Acoustic, 900M altitude
CLTT	3	Performance, 900M altitude
CLTT	4	Acoustic, 1500M altitude
CLTT	5	Performance, 1500M altitude
CLTT	6	Acoustic, 3000M altitude
CLTT	7	Performance, 3000M altitude

Each group of profiles allows for varying fan control policies based on the altitude. For a given altitude, the Tcontrol SDRs associated with an acoustics-optimized profile generate less noise than the equivalent performance-optimized profile by driving lower fan speeds, and the BIOS reduces thermal management requirements by configuring more aggressive memory throttling.

The BMC only supports enabling a fan profile through the command if that profile is supported on all fan domains defined for the given system. **It is important to configure platform Sensor Data Records (SDRs) so that all desired fan profiles are supported on each fan domain.** If no single profile is supported across all domains, the BMC, by default, uses profile 0 and does not allow it to be changed.

### 6.11.8 Thermal Sensor Input to Fan Speed Control

The BMC uses various IPMI sensors as input to the fan speed control. Some of the sensors are IPMI models of actual physical sensors whereas some are “virtual” sensors whose values are derived from physical sensors using calculations and/or tabular information.

The following IPMI thermal sensors are used as input to the fan speed control:

- Front Panel Temperature Sensor<sup>1</sup>
- Baseboard Temperature Sensor<sup>2</sup>
- CPU Margin Sensors<sup>3,5,6</sup>
- DIMM Thermal Margin Sensors<sup>3,5</sup>
- Exit Air Temperature Sensor<sup>1, 4, 8</sup>
- PCH Temperature Sensor<sup>4,6</sup>
- On-board Ethernet Controller Temperature Sensors<sup>4, 6</sup>
- Add-In Intel SAS/IO Module Temperature Sensors<sup>4, 6</sup>
- PSU Thermal Sensor<sup>4, 9</sup>
- CPU VR Temperature Sensors<sup>4, 7</sup>
- DIMM VR Temperature Sensors<sup>4, 7</sup>
- iBMC Temperature Sensor<sup>4, 7</sup>
- Global Aggregate Thermal Margin Sensors<sup>3, 8</sup>

**Note:**

1. For fan speed control in Intel chassis
2. For fan speed control in 3rd party chassis
3. Temperature margin from throttling threshold
4. Absolute temperature
5. PECL value
6. On-die sensor
7. On-board sensor
8. Virtual sensor
9. Available only when PSU has PMBus\*

The following illustration provides a simple model showing the fan speed control structure that implements the resulting fan speeds.

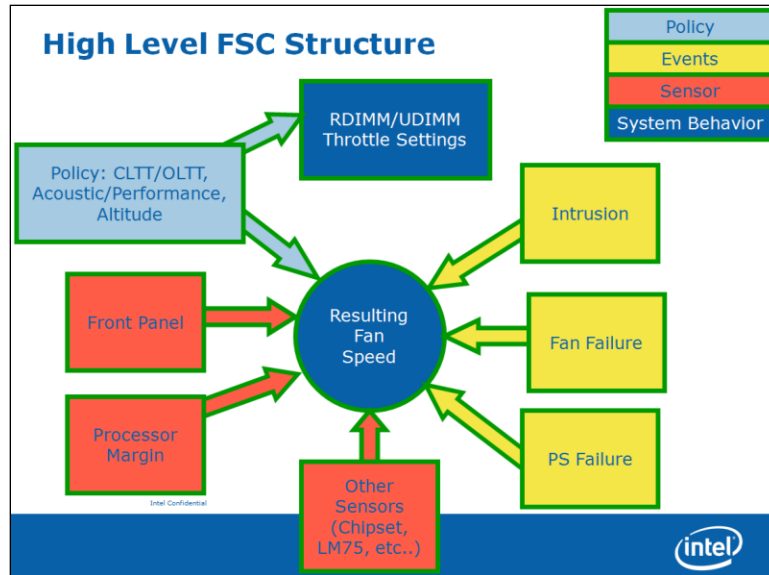

Figure 20. Fan Speed Control Process

### 6.11.9 Memory Thermal Throttling

The server board provides support for system thermal management through open loop throttling (OLTT) and closed loop throttling (CLTT) of system memory. Normal system operation uses closed-loop thermal throttling (CLTT) and DIMM temperature monitoring as major factors in overall thermal and acoustics management. In the event that BIOS is unable to configure the system for CLTT, it defaults to open-loop thermal throttling (OLTT). In the OLTT mode, it is assumed that the DIMM temperature sensors are not available for fan speed control. Throttling levels are changed dynamically to cap throttling based on memory and system thermal conditions as determined by the system and DIMM power and thermal parameters. The BMC's fan speed control functionality is linked to the memory throttling mechanism used.

The following terminology is used for the various memory throttling options:

- **Static Open Loop Thermal Throttling (Static-OLTT):** OLTT control registers that are configured by BIOS MRC remain fixed after post. The system does not change any of the throttling control registers in the embedded memory controller during runtime.
- **Static Closed Loop Thermal Throttling (Static-CLTT):** CLTT control registers are configured by BIOS MRC during POST. The memory throttling is run as a closed-loop system with the DIMM temperature sensors as the control input. Otherwise, the system does not change any of the throttling control registers in the embedded memory controller during runtime.
- **Dynamic Open Loop Thermal Throttling (Dynamic-OLTT):** OLTT control registers are configured by BIOS MRC during POST. Adjustments are made to the throttling during runtime based on changes in system cooling (fan speed).
- **Dynamic Closed Loop Thermal Throttling (Dynamic-CLTT):** CLTT control registers are configured by BIOS MRC during POST. The memory throttling is run as a closed-loop system with the DIMM temperature sensors as the control input. Adjustments are made to the throttling during runtime based on changes in system cooling (fan speed).

Both Static and Dynamic CLTT modes implement a Hybrid Closed Loop Thermal Throttling mechanism whereby the Integrated Memory Controller estimates the DRAM temperature in between actual reads of the memory thermal sensors.

## 6.12 Messaging Interfaces

The BMC supports the following communications interfaces:

- Host SMS interface by means of low pin count (LPC)/keyboard controller style (KCS) interface
- Host SMM interface by means of low pin count (LPC)/keyboard controller style (KCS) interface
- Intelligent Platform Management Bus (IPMB) I2C interface
- LAN interface using the IPMI-over-LAN protocols

Every messaging interface is assigned an IPMI channel ID by IPMI 2.0.

**Table 17. Messaging Interfaces**

Channel ID	Interface	Supports Sessions
0	Primary IPMB	No
1	LAN 1	Yes
2	LAN 2	Yes
3	LAN3 <sup>1</sup> (Provided by the Intel® Dedicated Server Management NIC)	Yes
4	Reserved	Yes
5	USB	No
6	Secondary IPMB	No
7	SMM	No
8–0Dh	Reserved	–
0Eh	Self <sup>2</sup>	–
0Fh	SMS/Receive Message Queue	No

**Notes:**

1. Optional hardware supported by the server system.
2. Refers to the actual channel used to send the request.

### 6.12.1 User Model

The BMC supports the IPMI 2.0 user model. 15 user IDs are supported. These 15 users can be assigned to any channel. The following restrictions are placed on user-related operations:

1. User names for User IDs 1 and 2 cannot be changed. These are always "" (Null/blank) and "root" respectively.
2. User 2 ("root") always has the administrator privilege level.
3. All user passwords (including passwords for 1 and 2) may be modified.

User IDs 3-15 may be used freely, with the condition that user names are unique. Therefore, no other users can be named "" (Null), "root," or any other existing user name.

### 6.12.2 IPMB Communication Interface

The IPMB communication interface uses the 100 KB/s version of an I<sup>2</sup>C bus as its physical medium. For more information on I<sup>2</sup>C specifications, see *The I<sup>2</sup>C Bus and How to Use It*. The IPMB implementation in the BMC is compliant with the *IPMB v1.0, revision 1.0*.

The BMC IPMB slave address is 20h.

The BMC both sends and receives IPMB messages over the IPMB interface. Non-IPMB messages received by means of the IPMB interface are discarded.

Messages sent by the BMC can either be originated by the BMC, such as initialization agent operation, or by another source. One example is KCS-IPMB bridging.

### 6.12.3 LAN Interface

The BMC implements both the IPMI 1.5 and IPMI 2.0 messaging models. These provide out-of-band local area network (LAN) communication between the BMC and the network.

See the *Intelligent Platform Management Interface Specification Second Generation v2.0* for details about the IPMI-over-LAN protocol.

Run-time determination of LAN channel capabilities can be determined by both standard IPMI defined mechanisms.

#### 6.12.3.1 RMCP/ASF Messaging

The BMC supports RMCP ping discovery in which the BMC responds with a pong message to an RMCP/ASF ping request. This is implemented per the *Intelligent Platform Management Interface Specification Second Generation v2.0*.

#### 6.12.3.2 BMC LAN Channels

The BMC supports three RMII/RGMII ports that can be used for communicating with Ethernet devices. Two ports are used for communication with the on-board NICs and one is used for communication with an Ethernet PHY located on an optional RMM4 add-in module.

##### 6.12.3.2.1 Baseboard NICs

The on-board Ethernet controller provides support for a Network Controller Sideband Interface (NC-SI) manageability interface. This provides a sideband high-speed connection for manageability traffic to the BMC while still allowing for a simultaneous host access to the OS if desired.

The NC-SI is a DMTF industry standard protocol for the side band management LAN interface. This protocol provides a fast multi-drop interface for management traffic.

The baseboard NIC(s) are connected to a single BMC RMII/RGMII port that is configured for RMII operation. The NC-SI protocol is used for this connection and provides a 100 Mb/s full-duplex multi-drop interface which allows multiple NICs to be connected to the BMC. The physical layer is based upon RMII, however RMII is a point-to-point bus whereas NC-SI allows 1 master and up to 4 slaves. The logical layer (configuration commands) is incompatible with RMII.

The server board will provide support for a dedicated management channel that can be configured to be hidden from the host and only used by the BMC. This mode of operation is configured through a BIOS setup option.

### **6.12.3.2.2 Dedicated Management Channel**

An additional LAN channel dedicated to BMC usage and not available to host SW is supported by an optional RMM4 add-in card. There is only a PHY device present on the RMM4 add-in card. The BMC has a built-in MAC module that uses the RGMII interface to link with the card's PHY. Therefore, for this dedicated management interface, the PHY and MAC are located in different devices.

The PHY on the RMM4 connects to the BMC's other RMII/RGMII interface (that is, the one that is not connected to the baseboard NICs). This BMC port is configured for RGMII usage. In addition to the use of an RMM4 add-in card for a dedicated management channel, on systems that support multiple Ethernet ports on the baseboard, the system BIOS provides a setup option to allow one of these baseboard ports to be dedicated to the BMC for manageability purposes. When this is enabled, that port is hidden from the OS.

### **6.12.3.2.3 Concurrent Server Management Use of Multiple Ethernet Controllers**

The BMC FW supports concurrent OOB LAN management sessions for the following combination:

- Two on-board NIC ports
- One on-board NIC and the optional dedicated RMM4 add-in management NIC.
- Two on-board NICs and optional dedicated RMM4 add-in management NIC.

All NIC ports must be on different subnets for the above concurrent usage models. MAC addresses are assigned for management NICs from a pool of up to three MAC addresses allocated specifically for manageability. The total number of MAC addresses in the pool is dependent on the product HW constraints (for example, a board with two NIC ports available for manageability would have a MAC allocation pool of 2 addresses). For these channels, support can be enabled for IPMI-over-LAN and DHCP.

For security reasons, embedded LAN channels have the following default settings:

- IP Address: Static
- All users disabled

IPMI-enabled network interfaces may not be placed on the same subnet. This includes the Intel® Dedicated Server Management NIC and either of the BMC's embedded network interfaces.

Host-BMC communication over the same physical LAN connection – also known as “loopback” – is not supported. This includes “ping” operations.

On server boards with more than two onboard NIC ports, only the first two ports can be used as BMC LAN channels. The remaining ports have no BMC connectivity.

Maximum bandwidth supported by BMC LAN channels are as follows:

- BMC LAN1 (Baseboard NIC port) ----- 100Mb (10Mb in DC off state)
- BMC LAN 2 (Baseboard NIC port) ----- 100Mb (10Mb in DC off state)
- BMC LAN 3 (Dedicated NIC) ----- 100Mb



### 6.12.3.3 IPv6 Support

In addition to IPv4, the server board has support for IPv6 for manageability channels. Configuration of IPv6 is provided by extensions to the IPMI Set & Get LAN Configuration Parameters commands as well as through a Web Console IPv6 configuration web page.

The BMC supports IPv4 and IPv6 simultaneously so they are both configured separately and completely independently. For example, IPv4 can be DHCP configured while IPv6 is statically configured or vice versa.

The parameters for IPv6 are similar to the parameters for IPv4 with the following differences:

- An IPv6 address is 16 bytes vs. 4 bytes for IPv4.
- An IPv6 prefix is 0 to 128 bits whereas IPv4 has a 4 byte subnet mask.
- The IPv6 Enable parameter must be set before any IPv6 packets will be sent or received on that channel.
- There are two variants of automatic IP Address Source configuration vs. just DHCP for IPv4.

The three possible IPv6 IP Address Sources for configuring the BMC are:

**Static (Manual):** The IP, Prefix, and Gateway parameters are manually configured by the user. The BMC ignores any Router Advertisement messages received over the network.

**DHCPv6:** The IP comes from running a DHCPv6 client on the BMC and receiving the IP from a DHCPv6 server somewhere on the network. The Prefix and Gateway are configured by Router Advertisements from the local router. The IP, Prefix, and Gateway are read-only parameters to the BMC user in this mode.

**Stateless auto-config:** The Prefix and Gateway are configured by the router through Router Advertisements. The BMC derives its IP in two parts: the upper network portion comes from the router and the lower unique portion comes from the BMC's channel MAC address. The 6-byte MAC address is converted into an 8-byte value per the EUI-64\* standard. For example, a MAC value of 00:15:17:FE:2F:62 converts into a EUI-64 value of 215:17ff:fefe:2f62. If the BMC receives a Router Advertisement from a router at IP 1:2:3:4::1 with a prefix of 64, it would then generate for itself an IP of 1:2:3:4:215:17ff:fefe:2f62. The IP, Prefix, and Gateway are read-only parameters to the BMC user in this mode.

IPv6 can be used with the BMC's Web Console, JViewer (remote KVM and Media), and Systems Management Architecture for Server Hardware – Command Line Protocol (SMASH-CLP) interface (ssh). There is no standard yet on how IPMI RMCP or RMCP+ should operate over IPv6 so that is not currently supported.

### 6.12.3.4 LAN Failover

The BMC FW provides a LAN failover capability such that the failure of the system HW associated with one LAN link will result in traffic being rerouted to an alternate link. This functionality is configurable by IPMI methods as well as through the BMC's Embedded UI, allowing for user to specify the physical LAN links constitute the redundant network paths or physical LAN links constitute different network paths. BMC will support only a "all or nothing" approach – that is, all interfaces bonded together, or none are bonded together.

The LAN Failover feature applies only to BMC LAN traffic. It bonds all available Ethernet devices but only one is active at a time. When enabled, if the active connection's leash is lost, one of the secondary connections is automatically configured so that it has the same IP address. Traffic immediately resumes on the new active connection.

The LAN Failover enable/disable command may be sent at any time. After it has been enabled, standard IPMI commands for setting channel configuration that specify a LAN channel other than the first will return an error code.

### 6.12.3.5 BMC IP Address Configuration

Enabling the BMC's network interfaces requires using the *Set LAN Configuration Parameter* command to configure LAN configuration parameter 4, *IP Address Source*. The BMC supports this parameter as follows:

- 1h, static address (manually configured): Supported on all management NICs. This is the BMC's default value.
- 2h, address obtained by BMC running DHCP: Supported only on embedded management NICs.

IP Address Source value 4h, address obtained by BMC running other address assignment protocol, is not supported on any management NIC.

Attempting to set an unsupported IP address source value has no effect, and the BMC returns error code 0xCC, Invalid data field-in request. Note that values 0h and 3h are no longer supported, and will return a 0xCC error completion code.

#### 6.12.3.5.1 Static IP Address (IP Address Source Values 0h, 1h, and 3h)

The BMC supports static IP address assignment on all of its management NICs. The IP address source parameter must be set to "static" before the IP address; the subnet mask or gateway address can be manually set.

The BMC takes no special action when the following IP address source is specified as the IP address source for any management NIC: 1h – Static address (manually configured)

The *Set LAN Configuration Parameter* command must be used to configure LAN configuration parameter 3, *IP Address*, with an appropriate value.

The BIOS does not monitor the value of this parameter, and it does not execute DHCP for the BMC under any circumstances, regardless of the BMC configuration.

#### 6.12.3.5.2 Static LAN Configuration Parameters

When the IP Address Configuration parameter is set to 01h (static), the following parameters may be changed by the user:

- LAN configuration parameter 3 (IP Address)
- LAN configuration parameter 6 (Subnet Mask)
- LAN configuration parameter 12 (Default Gateway Address)

When changing from DHCP to Static configuration, the initial values of these three parameters will be equivalent to the existing DHCP-set parameters. Additionally, the BMC observes the following network safety precautions:

1. The user may only set a subnet mask that is valid, per IPv4 and RFC 950 (*Internet Standard Subnetting Procedure*). Invalid subnet values return a 0xCC (Invalid Data Field in Request) completion code, and the subnet mask is not set. If no valid mask has been previously set, default subnet mask is 0.0.0.0.
2. The user may only set a default gateway address that can potentially exist within the subnet specified above. Default gateway addresses outside the BMC's subnet are technically unreachable and the BMC will not set the default gateway address to an unreachable value. The BMC returns a 0xCC (Invalid Data Field in Request) completion code for default gateway addresses outside its subnet.
3. If a command is issued to set the default gateway IP address before the BMC's IP address and subnet mask are set, the default gateway IP address is not updated and the BMC returns 0xCC.

If the BMC's IP address on a LAN channel changes while a LAN session is in progress over that channel, the BMC does not take action to close the session except through a normal session timeout. The remote client must re-sync with the new IP address. The BMC's new IP address is only available in-band through the "Get LAN Configuration Parameters" command.

#### **6.12.3.5.3 Enabling/Disabling Dynamic Host Configuration (DHCP) Protocol**

The BMC DHCP feature is activated by using the *Set LAN Configuration Parameter* command to set LAN configuration parameter 4, *IP Address Source*, to 2h: "address obtained by BMC running DHCP". Once this parameter is set, the BMC initiates the DHCP process within approximately 100 ms.

If the BMC has previously been assigned an IP address through DHCP or the *Set LAN Configuration Parameter* command, it requests that same IP address to be reassigned. If the BMC does not receive the same IP address, system management software must be reconfigured to use the new IP address. The new address is only available in-band, through the IPMI *Get LAN Configuration Parameters* command.

Changing the *IP Address Source* parameter from 2h to any other supported value will cause the BMC to stop the DHCP process. The BMC uses the most recently obtained IP address until it is reconfigured.

If the physical LAN connection is lost (that is, the cable is unplugged), the BMC will not re-initiate the DHCP process when the connection is re-established.

#### **6.12.3.5.4 DHCP-related LAN Configuration Parameters**

Users may not change the following LAN parameters while the DHCP is enabled:

- LAN configuration parameter 3 (IP Address)
- LAN configuration parameter 6 (Subnet Mask)
- LAN configuration parameter 12 (Default Gateway Address)

To prevent users from disrupting the BMC's LAN configuration, the BMC treats these parameters as read-only while DHCP is enabled for the associated LAN channel. Using the *Set LAN Configuration Parameter* command to attempt to change one of these parameters under

such circumstances has no effect, and the BMC returns error code 0xD5, “Cannot Execute Command. Command, or request parameter(s) are not supported in present state.”

### 6.12.3.6 DHCP BMC Hostname

The BMC allows setting a DHCP Hostname using the *Set/Get LAN Configuration Parameters* command.

- DHCP Hostname can be set regardless of the IP Address source configured on the BMC. But this parameter is only used if the IP Address source is set to DHCP.
- When Byte 2 is set to “Update in progress”, all the 16 Block Data Bytes (Bytes 3 – 18) must be present in the request.
- When Block Size < 16, it must be the last Block request in this series. In other words Byte 2 is equal to “Update is complete” on that request.
- Whenever Block Size < 16, the Block data bytes must end with a NULL Character or Byte (=0).
- All Block write requests are updated into a local Memory byte array. When Byte 2 is set to “Update is Complete”, the Local Memory is committed to the NV Storage. Local Memory is reset to NULL after changes are committed.
- When Byte 1 (Block Selector = 1), firmware resets all the 64 bytes local memory. This can be used to undo any changes after the last “Update in Progress”.
- User should always set the hostname starting from block selector 1 after the last “Update is complete”. If the user skips block selector 1 while setting the hostname, the BMC will record the hostname as “NULL,” because the first block contains NULL data.
- This scheme effectively does not allow a user to make a partial Hostname change. Any Hostname change needs to start from Block 1.
- Byte 64 ( Block Selector 04h byte 16) is always ignored and set to NULL by BMC which effectively means we can set only 63 bytes.
- User is responsible for keeping track of the Set series of commands and Local Memory contents.

While BMC firmware is in “Set Hostname in Progress” (Update not complete), the firmware continues using the Previous Hostname for DHCP purposes.

### 6.12.4 Address Resolution Protocol (ARP)

The BMC can receive and respond to ARP requests on BMC NICs. Gratuitous ARPs are supported, and disabled by default.

### 6.12.5 Internet Control Message Protocol (ICMP)

The BMC supports the following ICMP message types targeting the BMC over integrated NICs:

- Echo request (ping): The BMC sends an Echo Reply.
- Destination unreachable: If message is associated with an active socket connection within the BMC, the BMC closes the socket.

### 6.12.6 Virtual Local Area Network (VLAN)

The BMC supports VLAN as defined by IPMI 2.0 specifications. VLAN is supported internally by the BMC, not through switches. VLAN provides a way of grouping a set of systems together so that they form a logical network. This feature can be used to set up a management VLAN where only devices which are members of the VLAN will receive packets related to management and

members of the VLAN will be isolated from any other network traffic. Please note that VLAN does not change the behavior of the host network setting, it only affects the BMC LAN communication.

LAN configuration options are now supported (by means of the Set LAN Config Parameters command, parameters 20 and 21) that allow support for 802.1Q VLAN (Layer 2). This allows VLAN headers/packets to be used for IPMI LAN sessions. VLAN ID's are entered and enabled by means of parameter 20 of the Set LAN Config Parameters IPMI command. When a VLAN ID is configured and enabled, the BMC only accepts packets with that VLAN tag/ID. Conversely, all BMC generated LAN packets on the channel include the given VLAN tag/ID. Valid VLAN ID's are 1 through 4094, VLAN ID's of 0 and 4095 are reserved, per the 802.1Q VLAN specification. Only one VLAN can be enabled at any point in time on a LAN channel. If an existing VLAN is enabled, it must first be disabled prior to configuring a new VLAN on the same LAN channel. Parameter 21 (VLAN Priority) of the Set LAN Config Parameters IPMI command is now implemented and a range from 0-7 will be allowed for VLAN Priorities. Please note that bits 3 and 4 of Parameter 21 are considered Reserved bits.

Parameter 25 (VLAN Destination Address) of the Set LAN Config Parameters IPMI command is not supported and returns a completion code of 0x80 (parameter not supported) for any read/write of parameter 25.

If the BMC IP address source is DHCP, then the following behavior is seen:

- If the BMC is first configured for DHCP (prior to enabling VLAN), when VLAN is enabled, the BMC performs a discovery on the new VLAN in order to obtain a new BMC IP address.
- If the BMC is configured for DHCP (before disabling VLAN), when VLAN is disabled, the BMC performs a discovery on the LAN in order to obtain a new BMC IP address.

If the BMC IP address source is Static, then the following behavior is seen:

- If the BMC is first configured for static (prior to enabling VLAN), when VLAN is enabled, the BMC has the same IP address that was configured before. It is left to the management application to configure a different IP address if that is not suitable for VLAN.
- If the BMC is configure for static (prior to disabling VLAN), when VLAN is disabled, the BMC has the same IP address that was configured before. It is left to the management application to configure a different IP address if that is not suitable for LAN.

### 6.12.7 Secure Shell (SSH)

Secure Shell (SSH) connections are supported for SMASH-CLP sessions to the BMC.

### 6.12.8 Serial-over-LAN (SOL 2.0)

The BMC supports IPMI 2.0 SOL.

IPMI 2.0 introduced a standard serial-over-LAN feature. This is implemented as a standard payload type (01h) over RMCP+.

Three commands are implemented for SOL 2.0 configuration.

- “Get SOL 2.0 Configuration Parameters” and “Set SOL 2.0 Configuration Parameters”:  
These commands are used to get and set the values of the SOL configuration parameters. The parameters are implemented on a per-channel basis.

- “Activating SOL”: This command is not accepted by the BMC. It is sent by the BMC when SOL is activated to notify a remote client of the switch to SOL.
- Activating a SOL session requires an existing IPMI-over-LAN session. If encryption is used, it should be negotiated when the IPMI-over LAN session is established.

### 6.12.9 Platform Event Filter (PEF)

The BMC includes the ability to generate a selectable action, such as a system power-off or reset, when a match occurs to one of a configurable set of events. This capability is called *Platform Event Filtering*, or PEF. One of the available PEF actions is to trigger the BMC to send a LAN alert to one or more destinations.

The BMC supports 20 PEF filters. The first twelve entries in the PEF filter table are pre-configured (but may be changed by the user). The remaining entries are left blank, and may be configured by the user.

**Table 18. Factory Configured PEF Table Entries**

Event Filter Number	Offset Mask	Events
1	Non-critical, critical and non-recoverable	Temperature sensor out of range
2	Non-critical, critical and non-recoverable	Voltage sensor out of range
3	Non-critical, critical and non-recoverable	Fan failure
4	General chassis intrusion	Chassis intrusion (security violation)
5	Failure and predictive failure	Power supply failure
6	Uncorrectable ECC	BIOS
7	POST error	BIOS: POST code error
8	FRB2	Watchdog Timer expiration for FRB2
9	Policy Correction Time	Node Manager
10	Power down, power cycle, and reset	Watchdog timer
11	OEM system boot event	System restart (reboot)
12	Drive Failure, Predicted Failure	Hot Swap Controller

Additionally, the BMC supports the following PEF actions:

- Power off
- Power cycle
- Reset
- OEM action
- Alerts

The “Diagnostic interrupt” action is not supported.

#### 6.12.10 LAN Alerting

The BMC supports sending embedded LAN alerts, called SNMP PET (Platform Event traps), and SMTP email alerts.

The BMC supports a minimum of four LAN alert destinations.

##### 6.12.10.1 SNMP Platform Event Traps (PETs)

This feature enables a target system to send SNMP traps to a designated IP address by means of LAN. These alerts are formatted per the *Intelligent Platform Management Interface Specification Second Generation v2.0*. A Modular Information Block (MIB) file associated with

the traps is provided with the BMC firmware to facilitate interpretation of the traps by external software. The format of the MIB file is covered under RFC 2578.

### 6.12.11 Alert Policy Table

Associated with each PEF entry is an alert policy that determines which IPMI channel the alert is to be sent. There is a maximum of 20 alert policy entries. There are no pre-configured entries in the alert policy table because the destination types and alerts may vary by user. Each entry in the alert policy table contains four bytes for a maximum table size of 80 bytes.

#### 6.12.11.1 E-mail Alerting

The Embedded Email Alerting feature allows the user to receive e-mails alerts indicating issues with the server. This allows e-mail alerting in an OS-absent (for example, Pre-OS and OS-Hung) situation. This feature provides support for sending e-mail by means of SMTP, the Simple Mail Transport Protocol as defined in Internet RC 821. The e-mail alert provides a text string that describes a simple description of the event. SMTP alerting is configured using the embedded web server.

### 6.12.12 SM-CLP (SM-CLP Lite)

SMASH refers to Systems Management Architecture for Server Hardware. SMASH is defined by a suite of specifications, managed by the DMTF, that standardize the manageability interfaces for server hardware. CLP refers to Command Line Protocol. SM-CLP is defined by the *Server Management Command Line Protocol Specification (SM-CLP) ver1.0*, which is part of the SMASH suite of specifications. The specifications and further information on SMASH can be found at the DMTF website (<http://www.dmtf.org/>).

The BMC provides an embedded “lite” version of SM-CLP that is syntax-compatible but not considered fully compliant with the DMTF standards.

The SM-CLP utilized by a remote user by connecting a remote system through one of the system NICs. It is possible for third party management applications to create scripts using this CLP and execute them on server to retrieve information or perform management tasks such as reboot the server, configure events, and so on.

The BMC embedded SM-CLP feature includes the following capabilities:

- Power on/off/reset the server.
- Get the system power state.
- Clear the System Event Log (SEL).
- Get the interpreted SEL in a readable format.
- Initiate/terminate an Serial Over LAN session.
- Support “help” to provide helpful information
- Get/set the system ID LED.
- Get the system GUID
- Get/set configuration of user accounts.
- Get/set configuration of LAN parameters.
- Embedded CLP communication should support SSH connection.
- Provide current status of platform sensors including current values. Sensors include voltage, temperature, fans, power supplies, and redundancy (power unit and fan redundancy).

The embedded web server is supported over any system NIC port that is enabled for server management capabilities.

### 6.12.13 Embedded Web Server

BMC Base manageability provides an embedded web server and an OEM-customizable web GUI which exposes the manageability features of the BMC base feature set. It is supported over all on-board NICs that have management connectivity to the BMC as well as an optional RMM4 dedicated add-in management NIC. At least two concurrent web sessions from up to two different users is supported. The embedded web user interface shall support the following client web browsers:

- Microsoft Internet Explorer 7.0\*
- Microsoft Internet Explorer 8.0\*
- Microsoft Internet Explorer 9.0\*
- Mozilla Firefox 3.0\*
- Mozilla Firefox 3.5\*
- Mozilla Firefox 3.6\*

The embedded web user interface supports strong security (authentication, encryption, and firewall support) since it enables remote server configuration and control. Embedded web server uses ports #80 and #443. The user interface presented by the embedded web user interface shall authenticate the user before allowing a web session to be initiated. Encryption using 128-bit SSL is supported. User authentication is based on user id and password.

The GUI presented by the embedded web server authenticates the user before allowing a web session to be initiated. It presents all functions to all users but grays-out those functions that the user does not have privilege to execute. (for example, if a user does not have privilege to power control, then the item shall be displayed in grey-out font in that user's UI display). The web GUI also provides a launch point for some of the advanced features, such as KVM and media redirection. These features are grayed out in the GUI unless the system has been updated to support these advanced features.

Additional features supported by the web GUI includes:

- Presents all the Basic features to the users.
- Power on/off/reset the server and view current power state.
- Displays BIOS, BMC, ME and SDR version information.
- Display overall system health.
- Configuration of various IPMI over LAN parameters for both IPV4 and IPV6
- Configuration of alerting (SNMP and SMTP).
- Display system asset information for the product, board, and chassis.
- Display of BMC-owned sensors (name, status, current reading, enabled thresholds), including color-code status of sensors.
- Provides ability to filter sensors based on sensor type (Voltage, Temperature, Fan & Power supply related)
- Automatic refresh of sensor data with a configurable refresh rate.
- On-line help.
- Display/clear SEL (display is in easily understandable human readable format).
- Supports major industry-standard browsers (Microsoft Internet Explorer\* and Mozilla Firefox\*).
- Automatically logs out after user-configurable inactivity period.



- The GUI session automatically times-out after a user-configurable inactivity period. By default, this inactivity period is 30 minutes.
- Embedded Platform Debug feature - Allow the user to initiate a “diagnostic dump” to a file that can be sent to Intel for debug purposes.
- Virtual Front Panel. The Virtual Front Panel provides the same functionality as the local front panel. The displayed LEDs match the current state of the local panel LEDs. The displayed buttons (for example, power button) can be used in the same manner as the local buttons.
- Severity level indication of SEL events. The web server UI displays the severity level associated with each event in the SEL. The severity level correlates with the front panel system status LED ( “OK”, “Degraded”, “Non-Fatal”, or “Fatal”).
- Display of ME sensor data. Only sensors that have associated SDRs loaded will be displayed.
- Ability to save the SEL to a file.
- Ability to force HTTPS connectivity for greater security. This is provided through a configuration option in the UI.
- Display of processor and memory information as is available over IPMI over LAN.
- Ability to get and set Node Manager (NM) power policies.
- Display of power consumed by the server.
- Ability to view and configure VLAN settings.
- Warn user the reconfiguration of IP address will cause disconnect.
- Capability to block logins for a period of time after several consecutive failed login attempts. The lock-out period and the number of failed logins that initiates the lock-out period are configurable by the user.
- Server Power Control – Ability to force into Setup on a reset.

#### 6.12.14 Virtual Front Panel

- Virtual Front Panel is the module present as “Virtual Front Panel” on the left side in the embedded web server when “remote Control” tab is clicked.
- Main Purpose of the Virtual Front Panel is to provide the front panel functionality virtually.
- Virtual Front Panel (VFP) will mimic the status LED and Power LED status and Chassis ID alone. It is automatically in sync with BMC every 40 seconds.
- For any abnormal status LED state, Virtual Front Panel will get the reason behind the abnormal or status LED changes and displayed in VFP side.
- As Virtual Front Panel uses the chassis control command for power actions. It won’t log the Front button press event since Logging the front panel press event for Virtual Front Panel press will mislead the administrator.
- For Reset from Virtual Front Panel, the reset will be done by a “Chassis control” command.
- For Reset from Virtual Front Panel, the restart cause will be because of “Chassis control” command.
- During Power action, Power button/Reset button should not accept the next action until current Power action is complete and the acknowledgment from BMC is received.
- EWS will provide a valid message during Power action until it completes the current Power action.
- The VFP does not have any effect on whether the front panel is locked by “Set Front Panel Enables” command.
- The chassis ID LED provides a visual indication of a system being serviced. The state of the chassis ID LED is affected by the following actions:
- Toggled by turning the chassis ID button on or off.

- There is no precedence or lock-out mechanism for the control sources. When a new request arrives, previous requests are terminated. For example, if the chassis ID button is pressed, then the chassis ID LED changes to solid on. If the button is pressed again, then the chassis ID LED turns off.
- Note that the chassis ID will turn on because of the original chassis ID button press and will reflect in the Virtual Front Panel after VFP sync with BMC. Virtual Front Panel won't reflect the chassis LED software blinking by a software command as there is no mechanism to get the chassis ID Led status.
- Only Infinite chassis ID ON/OFF by a software command will reflect in EWS during automatic /manual EWS sync up with BMC.
- Virtual Front Panel help should available for virtual panel module.
- At present, NMI button in VFP is disabled in Romley. It can be used in future.

### 6.12.15 Embedded Platform Debug

The Embedded Platform Debug feature supports capturing low-level diagnostic data (applicable MSRs, PCI config-space registers, and so on). This feature allows a user to export this data into a file that is retrievable from the embedded web GUI, as well as through host and remote IPMI methods, for the purpose of sending to an Intel engineer for an enhanced debugging capability. The files are compressed, encrypted, and password protected. The file is not meant to be viewable by the end user but rather to provide additional debugging capability to an Intel support engineer.

A list of data that may be captured using this feature includes but is not limited to:

- Platform sensor readings – This includes all “readable” sensors that can be accessed by the BMC FW and have associated SDRs populated in the SDR repository. This does not include any “event-only” sensors. (All BIOS sensors and some BMC and ME sensors are “event-only”; meaning that they are not readable using an IPMI Get Sensor Reading command but rather are used just for event logging purposes).
- SEL – The current SEL contents are saved in both hexadecimal and text format.
- CPU/memory register data – useful for diagnosing the cause of the following system errors: CATERR, ERR[2], SMI timeout, PERR, and SERR. The debug data is saved and timestamped for the last 3 occurrences of the error conditions.
  - PCI error registers
  - MSR registers
  - MCH registers
- BMC configuration data
  - BMC FW debug log (that is, SysLog) – Captures FW debug messages.
  - *Non-volatile storage of captured data.* Some of the captured data will be stored persistently in the BMC's non-volatile flash memory and preserved across AC power cycles. Due to size limitations of the BMC's flash memory, it is not feasible to store all of the data persistently.
- *SMBIOS table data.* The entire SMBIOS table is captured from the last boot.
- *PCI configuration data for on-board devices and add-in cards.* The first 256 bytes of PCI configuration data is captured for each device for each boot.
- *System memory map.* The system memory map is provided by BIOS on the current boot. This includes the EFI memory map and the Legacy (E820) memory map depending on the current boot.
- *Power supplies debug capability.*

- *Capture of power supply “black box” data and power supply asset information.* Power supply vendors are adding the capability to store debug data within the power supply itself. The platform debug feature provides a means to capture this data for each installed power supply. The data can be analyzed by Intel for failure analysis and possibly provided to the power supply vendor as well. The BMC gets this data from the power supplies from the PMBus\* manufacturer-specific commands.
- *Storage of system identification in power supply.* The BMC copies board and system serial numbers and part numbers into the power supply whenever a new power supply is installed in the system or when the system is first powered on. This information is included as part of the power supply black box data for each installed power supply.
- *Accessibility from IPMI interfaces.* The platform debug file can be accessed from an external IPMI interface (KCS or LAN).
- *POST code sequence for the two most recent boots.* This is a best-effort data collection by the BMC as the BMC real-time response cannot guarantee that all POST codes are captured.
- *Support for multiple debug files.* The platform debug feature provides the ability to save data to 2 separate files that are encrypted with different passwords.
  - File #1 is strictly for viewing by Intel engineering and may contain BMC log messages (that is, syslog) and other debug data that Intel FW developers deem useful in addition to the data specified in this document.
  - File #2 can be viewed by Intel partners who have signed an NDA with Intel and its contents are restricted to specific data items specified in this with the exception of the BMC syslog messages and power supply “black box” data.

#### 6.12.15.1 Output Data Format

The diagnostic feature shall output a password-protected compressed HTML file containing specific BMC and system information. This file is not intended for end-customer usage, this file is for customer support and engineering only.

#### 6.12.15.2 Output Data Availability

The diagnostic data shall be available on-demand from the embedded web server, KCS, or IPMI over LAN commands.

#### 6.12.15.3 Output Data Categories

The following tables list the data to be provided in the diagnostic output.

**Table 19. Diagnostic Data**

Category	Data
Internal BMC Data	BMC uptime/load
	Process list
	Free Memory
	Detailed Memory List
	Filesystem List/Info
	BMC Network Info
	BMC Syslog
	BMC Configuration Data
External BMC Data	Hex SEL listing
	Human-readable SEL listing

Category	Data
External BIOS Data	Human-readable sensor listing
	BIOS configuration settings
	POST codes for the two most recent boots
System Data	SMBIOS table for the current boot
	256 bytes of PCI config data for each PCI device
	Memory Map (EFI and Legacy) for current boot

**Table 20. Additional Diagnostics on Error**

Category	Data
System Data	First 256 bytes of PCI config data for each PCI device
	PCI error registers
	MSR registers
	MCH registers

### 6.12.16 Data Center Management Interface (DCMI)

The *DCMI Specification* is an emerging standard that is targeted to provide a simplified management interface for Internet Portal Data Center (IPDC) customers. It is expected to become a requirement for server platforms which are targeted for IPDCs. DCMI is an IPMI-based standard that builds upon a set of required IPMI standard commands by adding a set of DCMI-specific IPMI OEM commands. Intel® S1400/S1600/S2400/S2600 Server Platforms will be implementing the mandatory DCMI features in the BMC firmware (DCMI 1.1 Errata 1 compliance). Please refer to DCMI 1.1 errata 1 spec for details. Only mandatory commands will be supported. No support for optional DCMI commands. Optional power management and SEL roll over feature is not supported. DCMI Asset tag will be independent of baseboard FRU asset Tag. Please refer table DCMI Group Extension Commands for more details on DCMI commands.

### 6.12.17 Lightweight Directory Authentication Protocol (LDAP)

The Lightweight Directory Access Protocol (LDAP) is an application protocol supported by the BMC for the purpose of authentication and authorization. The BMC user connects with an LDAP server for login authentication. This is only supported for non-IPMI logins including the embedded web UI and SM-CLP. IPMI users/passwords and sessions are not supported over LDAP.

LDAP can be configured (IP address of LDAP server, port, and so on) from the BMC's Embedded Web UI. LDAP authentication and authorization is supported over the any NIC configured for system management. The BMC uses a standard Open LDAP implementation for Linux\*.

Only open LDAP is supported by BMC, Windows\* and Novell\* LDAP are not supported.

## 7. Advanced Management Feature Support (RMM4)

The integrated baseboard management controller has support for advanced management features which are enabled when an optional Intel® Remote Management Module 4 (RMM4) is installed.

RMM4 is comprised of two boards – RMM4 lite and the optional Dedicated Server Management NIC (DMN).

**Table 21. RMM4 Option Kits**

Intel Product Code	Description	Kit Contents	Benefits
AXXRMM4LITE	Intel® Remote Management Module 4 Lite	RMM4 Lite Activation Key	Enables KVM & media redirection from the onboard NIC.
AXXRMM4	Intel® Remote Management Module 4	RMM4 Lite Activation Key Dedicated NIC Port Module	Dedicated NIC for management traffic. Higher bandwidth connectivity for KVM & media Redirection with 100Mbe NIC.

On the server board each Intel® RMM4 component is installed at the following locations.

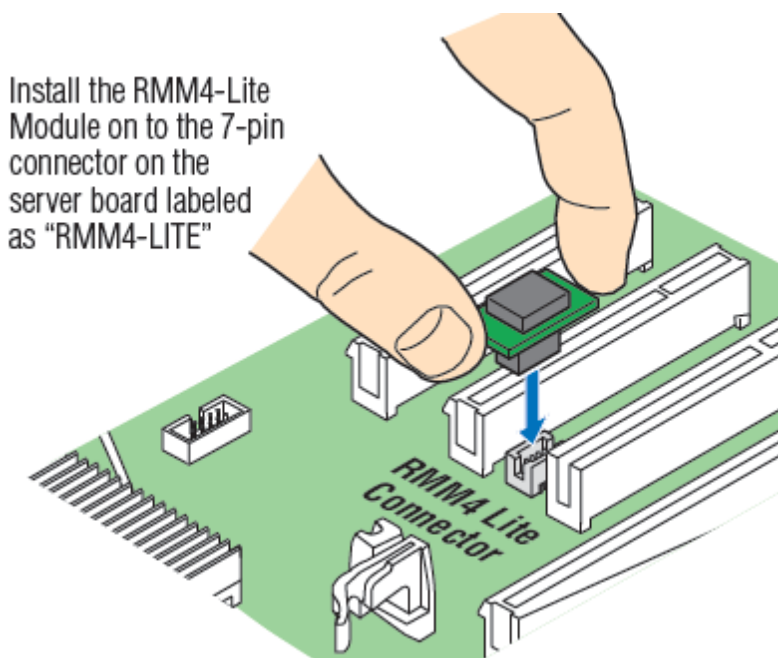

**Figure 21. Intel® RMM4 Lite Activation Key Installation**

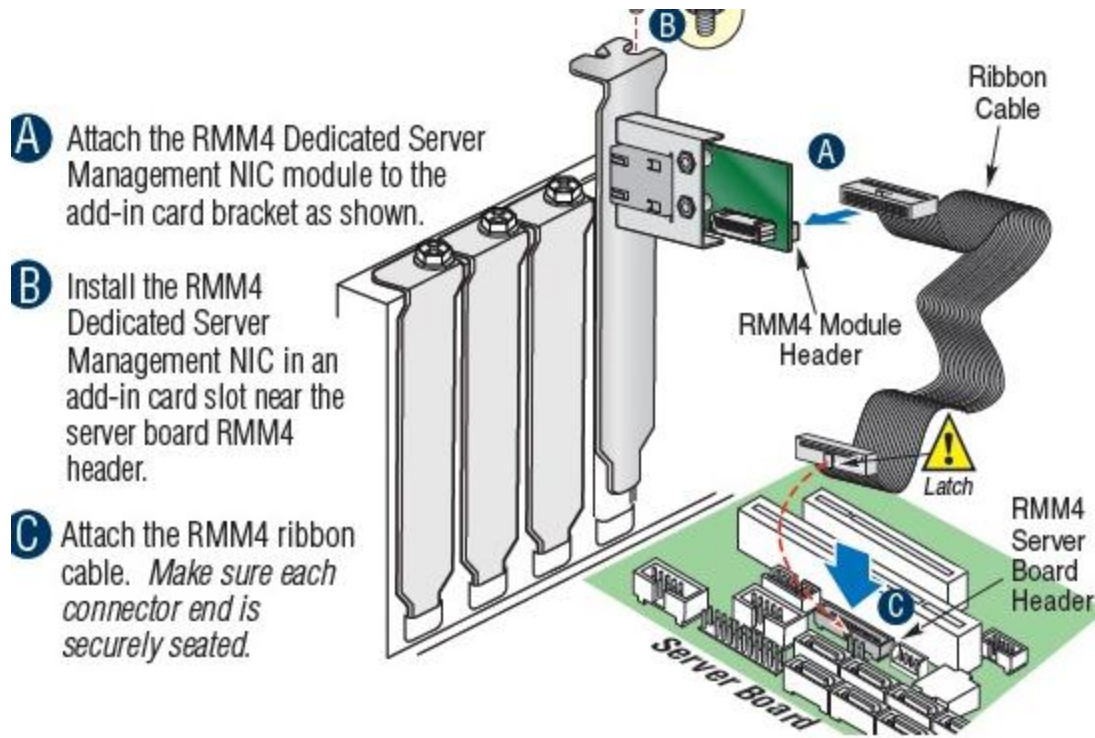

**Figure 22. Intel® RMM4 Dedicated Management NIC Installation**

If the optional Dedicated Server Management NIC is not used then the traffic can only go through the onboard Integrated BMC-shared NIC and will share network bandwidth with the host system. *Advanced* manageability features are supported over all NIC ports enabled for server manageability.

## 7.1 Keyboard, Video, Mouse (KVM) Redirection

The BMC firmware supports keyboard, video, and mouse redirection (KVM) over LAN. This feature is available remotely from the embedded web server as a Java applet. This feature is only enabled when the Intel® RMM4 lite is present. The client system must have a Java Runtime Environment (JRE) version 6.0 or later to run the KVM or media redirection applets.

The BMC supports an embedded KVM application (*Remote Console*) that can be launched from the embedded web server from a remote console. USB1.1 or USB 2.0 based mouse and keyboard redirection are supported. It is also possible to use the KVM-redirection (KVM-r) session concurrently with media-redirection (media-r). This feature allows a user to interactively use the keyboard, video, and mouse (KVM) functions of the remote server as if the user were physically at the managed server.

KVM redirection console support the following keyboard layouts: English, Dutch, French, German, Italian, Russian, and Spanish.

KVM redirection includes a “soft keyboard” function. The “soft keyboard” is used to simulate an entire keyboard that is connected to the remote system. The “soft keyboard” functionality supports the following layouts: English, Dutch, French, German, Italian, Russian, and Spanish.

The KVM-redirection feature automatically senses video resolution for best possible screen capture and provides high-performance mouse tracking and synchronization. It allows remote viewing and configuration in pre-boot POST and BIOS setup, once BIOS has initialized video. Other attributes of this feature include:

- Encryption of the redirected screen, keyboard, and mouse
- Compression of the redirected screen.
- Ability to select a mouse configuration based on the OS type.
- supports user definable keyboard macros.

KVM redirection feature supports the following resolutions and refresh rates:

- 640x480 at 60Hz, 72Hz, 75Hz, 85Hz, 100Hz
- 800x600 at 60Hz, 72Hz, 75Hz, 85Hz
- 1024x768 at 60Hz, 72Hz, 75Hz, 85Hz
- 1280x960 at 60Hz
- 1280x1024 at 60Hz
- 1600x1200 at 60Hz
- 1920x1080 (1080p),
- 1920x1200 (WUXGA)
- 1650x1080 (WSXGA+)

### 7.1.1 Remote Console

The Remote Console is the redirected screen, keyboard and mouse of the remote host system. To use the Remote Console window of your managed host system, the browser must include a Java\* Runtime Environment plug-in. If the browser has no Java support, such as with a small handheld device, the user can maintain the remote host system using the administration forms displayed by the browser.

The Remote Console window is a Java Applet that establishes TCP connections to the BMC. The protocol that is run over these connections is a unique KVM protocol and not HTTP or HTTPS. This protocol uses ports #7578 for KVM, #5120 for CDROM media redirection, and #5123 for Floppy/USB media redirection. When encryption is enabled, the protocol uses ports #7582 for KVM, #5124 for CDROM media redirection, and #5127 for Floppy/USB media redirection. The local network environment must permit these connections to be made, that is, from the firewall and, in case of a private internal network, the NAT (Network Address Translation) settings have to be configured accordingly.

### 7.1.2 Performance

The remote display accurately represents the local display. The feature adapts to changes to the video resolution of the local display and continues to work smoothly when the system transitions from graphics to text or vice-versa. The responsiveness may be slightly delayed depending on the bandwidth and latency of the network.

Enabling KVM and/or media encryption will degrade performance. Enabling video compression provides the fastest response while disabling compression provides better video quality. For the best possible KVM performance, a 2Mb/sec link or higher is recommended. The redirection of KVM over IP is performed in parallel with the local KVM without affecting the local KVM operation.

### 7.1.3 Security

The KVM redirection feature supports multiple encryption algorithms, including RC4 and AES. The actual algorithm that is used is negotiated with the client based on the client's capabilities.

### 7.1.4 Availability

The remote KVM session is available even when the server is powered-off (in stand-by mode). No re-start of the remote KVM session shall be required during a server reset or power on/off. An BMC reset (for example, due to an BMC Watchdog initiated reset or BMC reset after BMC FW update) will require the session to be re-established.

KVM sessions persist across system reset, but not across an AC power loss.

### 7.1.5 Usage

As the server is powered up, the remote KVM session displays the complete BIOS boot process. The user is able interact with BIOS setup, change and save settings as well as enter and interact with option ROM configuration screens.

At least two concurrent remote KVM sessions are supported. It is possible for at least two different users to connect to same server and start remote KVM sessions

### 7.1.6 Force-enter BIOS Setup

KVM redirection can present an option to force-enter BIOS Setup. This enables the system to enter F2 setup while booting which is often missed by the time the remote console redirects the video.

## 7.2 Media Redirection

The embedded web server provides a Java applet to enable remote media redirection. This may be used in conjunction with the remote KVM feature, or as a standalone applet.

The media redirection feature is intended to allow system administrators or users to mount a remote IDE or USB CD-ROM, floppy drive, or a USB flash disk as a remote device to the server. Once mounted, the remote device appears just like a local device to the server, allowing system administrators or users to install software (including operating systems), copy files, update BIOS, and so on, or boot the server from this device.

The following capabilities are supported:

- The operation of remotely mounted devices is independent of the local devices on the server. Both remote and local devices are useable in parallel.
- Either IDE (CD-ROM, floppy) or USB devices can be mounted as a remote device to the server.
- It is possible to boot all supported operating systems from the remotely mounted device and to boot from disk IMAGE (\*.IMG) and CD-ROM or DVD-ROM ISO files. See the Tested/supported Operating System List for more information.
- Media redirection supports redirection for both a virtual CD device and a virtual Floppy/USB device concurrently. The CD device may be either a local CD drive or else an ISO image file; the Floppy/USB device may be either a local Floppy drive, a local USB device, or else a disk image file.
- The media redirection feature supports multiple encryption algorithms, including RC4 and AES. The actual algorithm that is used is negotiated with the client based on the client's capabilities.
- A remote media session is maintained even when the server is powered-off (in standby mode). No restart of the remote media session is required during a server reset or power on/off. An BMC reset (for example, due to an BMC reset after BMC FW update) will require the session to be re-established



- The mounted device is visible to (and useable by) managed system's OS and BIOS in both pre-boot and post-boot states.
- The mounted device shows up in the BIOS boot order and it is possible to change the BIOS boot order to boot from this remote device.
- It is possible to install an operating system on a bare metal server (no OS present) using the remotely mounted device. This may also require the use of KVM-r to configure the OS during install.

USB storage devices will appear as floppy disks over media redirection. This allows for the installation of device drivers during OS installation.

If either a virtual IDE or virtual floppy device is remotely attached during system boot, both the virtual IDE and virtual floppy are presented as bootable devices. It is not possible to present only a single-mounted device type to the system BIOS.

### 7.2.1 Availability

The default inactivity timeout is 30 minutes and is not user-configurable. Media redirection sessions persist across system reset but not across an AC power loss or BMC reset.

### 7.2.2 Network Port Usage

The KVM and media redirection features use the following ports:

- 5120 – CD Redirection
- 5123 – FD Redirection
- 5124 – CD Redirection (Secure)
- 5127 – FD Redirection (Secure)
- 7578 – Video Redirection
- 7582 – Video Redirection (Secure)

## 8. On-board Connector/Header Overview

### 8.1 Board Connector Information

The following section provides detailed information regarding all connectors, headers, and jumpers on the server boards.

The following table lists all connector types available on the board and the corresponding preference designators printed on the silkscreen.

**Table 22. Board Connector Matrix**

Connector	Quantity	Reference Designators	Connector Type	Pin Count
Power supply	4	J1H3 J5J2 J8A1 J1J2	Main power CPU 1 power CPU 2 Power P/S aux/IPMB	24 8 8 5
CPU	2	U6G1, U7C1	CPU sockets	1356
Main memory	8	J8G1,J8G2,J8G3,J9G1,J4D1,J4D2,J5D1,J5D2	DIMM sockets	240
PCI Express* x8	3	J3C1,J3C2,J2C1	Card edge	98
PCI Express* x16	1	J4C1	Card edge	164
32-bit PCI	1	J1C2,	Card edge	124
Intel® RMM4	1	J1C7	Connector	30
Intel® RMM4 Lite	1	J3D1	Connector	7
Storage Upgrade Key	1	J1D2	Header	4
System fans	6	J3J3,J2J8,J2J6,J3J2,J2J5,J2J7	Header	6
System fans	1	J9A1	Header	4
CPU fans	2	J5J1,J7A1	Header	4
Battery	1	BT3G2	Battery holder	2
Stacked RJ45/2xUSB	2	U6A1, U7A1	External LAN built-in magnetic and dual USB	22
Video	1	J7A2	External DSub	15
Serial port A	1	J8A2	Connector	9
Serial port B	1	J1B1	Header	9
Front panel	1	J1C3	Header	24
Internal USB	2	J1C2	Header	10
USB Solid State Drive	1	J2E1	Header	9
Internal USB	1	J1J1	Type-A USB	4
HDD activity	1	J2H2	Header	2
Serial ATA	6	J1G1,J1F1,J2H1,J1H2,J1H1,J1G2	Header	7
SAS	2	J1D3, J1E1	SFF8087 miniSAS	36
HSBP_I2C	1	J3J1	Header	3
SATA SGPIO	1	J2J4	Header	4
LCP	1	J3J4	Header	7

Connector	Quantity	Reference Designators	Connector Type	Pin Count
IPMB	1	J1J3	Header	4
Configuration jumpers	6	J1C4 (BMC Force Update), J1C5 (BIOS Recovery), J2J3 (BIOS Default), J2J2 (ME Force Update), J2J6 (Password Clear), J2J4 (CPLD Update)	Jumper	3
TPM	1	J4J1	Connector	14

## 8.2 Power Connectors

The main power supply connection uses an SSI-compliant 2x12 pin connector (J1H3).

Three additional power-related connectors also exist:

- Two SSI-compliant 2x4 pin power connectors (J9A1, J9K1) to provide 12-V power to the CPU voltage regulators and memory.
- One SSI-compliant 1x5 pin connector (J9K2) to provide I<sup>2</sup>C monitoring of the power supply.

The following tables define these connector pin-outs:

**Table 23. Main Power Connector Pin-out (J1H3)**

Pin	Signal	Color	Pin	Signal	Color
1	+3.3 Vdc	Orange	13	+3.3 Vdc	Orange
2	+3.3 Vdc	Orange	14	-12 Vdc	Blue
3	GND	Black	15	GND	Black
4	+5 Vdc	Red	16	PS_ON#	Green
5	GND	Black	17	GND	Black
6	+5 Vdc	Red	18	GND	Black
7	GND	Black	19	GND	Black
8	PWR_OK	Gray	20	NC	White
9	5 VSB	Purple	21	+5 Vdc	Red
10	+12 Vdc	Yellow	22	+5 Vdc	Red
11	+12 Vdc	Yellow	23	+5 Vdc	Red
12	+3.3 Vdc	Orange	24	GND	Black

**Table 24. CPU 1/CPU 2 Power Connector Pin-out (J5J2, J8A1)**

Pin	Signal	Color
1	GND of Pin 5	Black
2	GND of Pin 6	Black
3	GND of Pin 7	Black
4	GND of Pin 8	Black
5	+12 Vdc CPU1	Yellow/black
6	+12 Vdc CPU1	Yellow/black
7	+12 Vdc DDR3_CPU1	Yellow/black
8	+12 Vdc DDR3_CPU1	Yellow/black

**Table 25. Power Supply Auxiliary Signal Connector Pin-out (J1J2)**

Pin	Signal	Color
1	SMB_CLK_FP_PWR_R	Orange
2	SMB_DAT_FP_PWR_R	Black

Pin	Signal	Color
3	SMB_ALRT_3_ESB_R	Red
4	3.3 V SENSE-	Yellow
5	3.3 V SENSE+	Green

## 8.3 System Management Headers

### 8.3.1 Intel® Remote Management Module 4 Connector

A 30-pin Intel® RMM4 connector (J1C7) and a 7-pin Intel® RMM4 Lite connector (J3D1) are included on the server board to support the optional Intel® Remote Management Module 4 or Intel® Remote Management Module 4 Lite. This server board does not support third-party management cards.

**Note:** This connector is not compatible with the previous generation Intel® Remote Management Modules (Intel® RMM/RMM2/RMM3)

**Table 26. Intel® RMM4 Connector Pin-out (J1C7)**

Pin	Signal Name	Pin	Signal Name
1	3V3_AUX	2	MDIO
3	3V3_AUX	4	MDC
5	GND	6	TXD_0
7	GND	8	TXD_1
9	GND	10	TXD_2
11	GND	12	TXD_3
13	GND	14	TX_CTL
15	GND	16	RX_CTL
17	GND	18	RXD_0
19	GND	20	RXD_1
21	GND	22	RXD_2
23	GND	24	RXD_3
25	GND	26	TX_CLK
27	GND	28	RX_CLK
29	GND	30	PRESENT#

**Table 27. Intel® RMM4 – Lite Connector Pin-out (J3D1)**

Pin	Signal Name	Pin	Signal Name
1	3V3_AUX	2	SPI_RMM4_LITE_DI
3	N/A	4	SPI_RMM4_LITE_CLK
5	SPI_RMM4_LITE_DO	6	GND
7	SPI_RMM4_LITE_CS_N	8	GND

### 8.3.2 TPM connector

**Table 28. TPM connector Pin-out (J4J1)**

Pin	Signal Name	Pin	Signal Name
1	No pin	2	LPC_LAD<1>
3	LPC_LAD<0>	4	GND
5	IRQ_SERIAL	6	LPC_FRAME_N
7	P3V3	8	GND
9	RST_IBMC_NIC_N	10	CLK_33M_TPM_CONN

Pin	Signal Name	Pin	Signal Name
11	LPC_LAD<3>	12	GND
13	GND	14	LPC_LAD<2>

### 8.3.3 LCP Header

**Table 29. LCP Header Pin-out (J3J4)**

Pin	Signal Name
1	SMB_SENSOR_3V3STBY_DATA
2	GND
3	SMB_SENSOR_3V3STBY_CLK
4	P3V3_AUX
5	FM_LCP_ENTER_N
6	FM_LCP_LEFT_N
7	FM_LCP_RIGHT_N

### 8.3.4 HSBP Header

**Table 30. HSBP\_I2C Header Pin-out (J3J1)**

Pin	Signal Name
1	SMB_HSBP_3V3STBY_DATA
2	GND
3	SMB_HSBP_3V3STBY_CLK

### 8.3.5 SATA SGPIO Header

**Table 31. SATA SGPIO Header Pin-out(J2J4)**

Pin	Signal Name	Description
1	SGPIO_CLOCK	SGPIO Clock Signal
2	SGPIO_LOAD	SGPIO Load Signal
3	GND	Ground
4	SGPIO_DATAOUT0	SGPIO Data Out
5	SGPIO_DATAOUT1	SGPIO Data Out

## 8.4 Front Panel Connector

The server board provides a 24-pin SSI front panel connector (J1C3) for use with Intel® and third-party chassis. The following table provides the pin-out for this connector:

**Table 32. Front Panel SSI Standard 24-pin Connector Pin-out (J1C3)**

	Pin	Signal Name	Description	Pin	Signal Name	Description
	1	P3V3_STBY (Power_LED_Anode)	Power LED +	2	P3V3_STBY	Front Panel Power
	3	Key	No Connection	4	P5V_STBY (ID LED Anode)	ID LED +
	5	FP_PWR_LED_N	Power LED -	6	FP_ID_LED_BU F_N	ID LED -
	7	P3V3 (HDD_ACTIVITY_Anode)	HDD Activity LED +	8	FP_LED_STATU S_GREEN_N	Status LED Green -
	9	LED_HDD_ACTIVITY_N	HDD Activity LED -	10	FP_LED_STATU S_AMBER_N	Status LED Amber -
	11	FP_PWR_BTN_N	Power Button	12	NIC1_ACT_LED_N	P3V3 STBY
	13	GND (Power Button GND)	Power Button Ground	14	NIC1_LINK_LED_N	NIC 1 Link/Activity LED -
	15	BMC_RST_BTN_N	Reset Button	16	SMB_SENSOR_3V3STB_DATA	SMB Sensor DATA
	17	BND (Reset GND)	Reset Button Ground	18	SMB_SENSOR_3V3STB_CLK	SMB Sensor Clock
	19	FP_ID_BTN_N	ID Button	20	FP_CHASSIS_INTRU	Chassis Intrusion
	21	FM_SIO_TEMP_SENSOR	Front Panel Temperature Sensor	22	NIC2_ACT_LED_N	P3V3 STBY
	23	FP_NMI_BTN_N	NMI Button	24	NIC2_LINK_LED_N	NIC 2 Link/Activity LED

## 8.5 I/O Connectors

### 8.5.1 VGA Connector

The following table details the pin-out definition of the VGA connector (J7A2) that is part of the stacked video/serial port A connector.

**Table 33. VGA Connector Pin-out (J7A2)**

Pin	Signal Name	Description
1	V_IO_R_CONN	Red (analog color signal R)
2	V_IO_G_CONN	Green (analog color signal G)
3	V_IO_B_CONN	Blue (analog color signal B)
4	TP_VID_CONN_B4	No connection
5	GND	Ground
6	GND	Ground
7	GND	Ground
8	GND	Ground
9	P5V	+5V DC
10	GND	Ground
11	TP_VID_CONN_B11	No connection
12	V_IO_DDCDAT	DDCDAT
13	V_IO_HSYNC_CONN	HSYNC (horizontal sync)
14	V_IO_VSYNC_CONN	VSYNC (vertical sync)
15	V_IO_DDCCLK	DDCCLK

## 8.5.2 SATA Connectors

The server board provides up to 6 SATA connectors: SATA-0 (J1G1), SATA-1 (J1F1), SATA-2 (J2H1), SATA-3 (J1H2), SATA-4 (J1H1), and SATA-5 (J1G2) and 2 miniSAS connectors: SCU-0 (J1D3), and SCU-1 (J1E1).

The pin configuration for each connector is identical and defined in the following table:

**Table 34. SATA Connector Pin-out (J1G1, J1F1, J2H1, J1H2, J1H1, J1G2)**

Pin	Signal Name	Description
1	GND	Ground
2	SATA TX_P_C	Positive side of transmit differential pair
3	SATA TX_N_C	Negative side of transmit differential pair
4	GND	Ground
5	SATA_RX_N_C	Negative side of receive differential pair
6	SATA_RX_P_C	Positive side of receive differential pair
7	GND	Ground

**Table 35. miniSAS Connector Pin-out (J1D3, J1E1)**

Signal Description	Pin#	Pin#	Signal Description
GROUND	A1	B1	GROUND
SAS0_RX_C_DP	A2	B2	SAS0_TX_C_DP
SAS0_RX_C_DN	A3	B3	SAS0_TX_C_DN
GROUND	A4	B4	GROUND
SAS1_RX_C_DP	A5	B5	SAS1_TX_C_DP
SAS1_RX_C_DN	A6	B6	SAS1_TX_C_DN
GROUND	A7	B7	GROUND
TP_SAS1_BACKPLANE_TYPE	A8	B8	SGPIO_SAS1_CLOCK
GROUND	A9	B9	SGPIO_SAS1_LOAD
SGPIO_SAS1_DATAOUT	A10	B10	GROUND
SGPIO_SAS1_DATAIN	A11	B11	PD_SAS1_CONTROLLER_TYPE
GROUND	A12	B12	GROUND
SAS2_RX_C_DP	A13	B13	SAS2_TX_C_DP
SAS2_RX_C_DN	A14	B14	SAS2_TX_C_DN
GROUND	A15	B15	GROUND
SAS3_RX_C_DP	A16	B16	SAS3_TX_C_DP
SAS3_RX_C_DN	A17	B17	SAS3_TX_C_DN
GROUND	A18	B18	GROUND
GROUND	MTH1	MTH5	GROUND
GROUND	MTH2	MTH6	GROUND
GROUND	MTH3	MTH7	GROUND
GROUND	MTH4	MTH8	GROUND

**Table 36. miniSAS Connector Pin-out (J1D3, J1E1)**

Signal Description	Pin#	Pin#	Signal Description
GROUND	A1	B1	GROUND
SAS4_RX_C_DP	A2	B2	SAS4_TX_C_DP
SAS4_RX_C_DN	A3	B3	SAS4_TX_C_DN
GROUND	A4	B4	GROUND
SAS5_RX_C_DP	A5	B5	SAS5_TX_C_DP
SAS5_RX_C_DN	A6	B6	SAS5_TX_C_DN
GROUND	A7	B7	GROUND
TP_SAS2_BACKPLANE_TYPE	A8	B8	SGPIO_SAS2_CLOCK
GROUND	A9	B9	SGPIO_SAS2_LOAD
SGPIO_SAS2_DATAOUT	A10	B10	GROUND
SGPIO_SAS2_DATAIN	A11	B11	PD_SAS2_CONTROLLER_TYPE
GROUND	A12	B12	GROUND

Signal Description	Pin#	Pin#	Signal Description
SAS6_RX_C_DP	A13	B13	SAS6_TX_C_DP
SAS6_RX_C_DN	A14	B14	SAS6_TX_C_DN
GROUND	A15	B15	GROUND
SAS7_RX_C_DP	A16	B16	SAS7_TX_C_DP
SAS7_RX_C_DN	A17	B17	SAS7_TX_C_DN
GROUND	A18	B18	GROUND
GROUND	MTH1	MTH5	GROUND
GROUND	MTH2	MTH6	GROUND
GROUND	MTH3	MTH7	GROUND
GROUND	MTH4	MTH8	GROUND

### 8.5.3 Serial Port Connectors

The server board provides one external DB9 Serial A port (J8A1) and one internal 9-pin Serial B header (J1B1). The following tables define the pin-outs.

**Table 37. External DB9 Serial A Port Pin-out (J8A2)**

Pin	Signal Name	Description
1	SPA_DCD	DCD (carrier detect)
2	SPA_SIN_L	RXD (receive data)
3	SPA_SOUT_N	TXD (Transmit data)
4	SPA_DTR	DTR (Data terminal ready)
5	GND	Ground
6	SPA_DSR	DSR (data set ready)
7	SPA_RTS	RTS (request to send)
8	SPA_CTS	CTS (clear to send)
9	SPA_RI	RI (Ring Indicate)

**Table 38. Internal 9-pin Serial B Header Pin-out (J1B1)**

Pin	Signal Name	Description
1	SPB_DCD	DCD (carrier detect)
2	SPB_DSR	DSR (data set ready)
3	SPB_SIN_L	RXD (receive data)
4	SPB_RTS	RTS (request to send)
5	SPB_SOUT_N	TXD (Transmit data)
6	SPB_CTS	CTS (clear to send)
7	SPB_DTR	DTR (Data terminal ready)
8	SPB_RI	RI (Ring indicate)
9	GND	Ground

### 8.5.4 USB Connector

The following table details the pin-out of the external USB connectors (J5A1, J6A1) found on the back edge of the server boards.

**Table 39. External USB Connector Pin-out (U6A1, U7A1)**

Pin	Signal Name	Description
1	USB_OC_5VSB	USB_PWR
2	USB_PN	DATAL0 (Differential data line paired with DATAH0)
3	USB_PP	DATAH0 (Differential data line paired with DATAL0)
4	GND	Ground



One 2x5 connectors on the server board (J1C2) provides support for two additional USB ports. J1C2 is recommended for front panel USB ports.

**Table 40. Internal USB Connector Pin-out (J1C2)**

Pin	Signal Name	Description
1	USB_PWR_5V	USB power
2	USB_PWR_5V	USB power
3	USB_PN_CONN	USB port negative signal
4	USB_PN_CONN	USB port negative signal
5	USB_PP_CONN	USB port positive signal
6	USB_PP_CONN	USB port positive signal
7	Ground	
8	Ground	
9	Key	No pin
10	TP_USB_NC	Test point

One low-profile 2x5 connector (J2E1) on the server boards provides an option to support a low-profile USB Solid State Drive.

**Table 41. Pin-out of Internal Low-Profile USB Connector for Solid State Drive (J2E1)**

Pin	Signal	Pin	Signal
1	+5V	6	NC
2	USB_N	7	NC
3	USB_P	8	NC
4	GND	9	NC
5	Key Pin	10	LED#

The server board provides one additional Type A USB port (J1J1) to support the installation of a USB device inside the server chassis.

**Table 42. Internal Type A USB Port Pin-out (J1J1)**

Pin	Signal Name	Description
1	USB_PWR7_5V	USB_PWR
2	USB_PN	USB port negative signal
3	USB_PP	USB port positive signal
4	GND	Ground

## 8.6 Fan Headers

The server board provides three SSI-compliant 4-pin and six SSI-compliant 6-pin fan headers to use as CPU and I/O cooling fans. 3-pin fans are supported on all fan headers. 6-pin fans are supported on headers J3J3, J2J10, J2J8, J3J2, J2J9 and J2J7. 4-pin fans are supported on headers J5J1, J7A1, J9A1, J3J3, J2J10, J2J8, J3J2, J2J9 and J2J7. The pin configuration for each of the 4-pin and 6-pin fan headers is identical and defined in the following tables.

- Two 4-pin fan headers are designated as processor cooling fans:
  - CPU1 fan (J5J1)
  - CPU2 fan (J7A1)

- Four 6-pin fan headers are designated as hot-swap system fans:
  - Hot-swap system fan 1 (J2J5)
  - Hot-swap system fan 2 (J2J6)
  - Hot-swap system fan 3 (J2J7)
  - Hot-swap system fan 4 (J2J8)
  - Hot-swap system fan 5 (J3J2)
  - Hot-swap system fan 6 (J3J3)
- One 4-pin fan header is designated as a rear system fan:
  - System fan 7 (J9A1)

**Table 43. SSI 4-pin Fan Header Pin-out (J5J1, J7A1, J9A1)**

Pin	Signal Name	Type	Description
1	Ground	GND	Ground is the power supply ground
2	12V	Power	Power supply 12 V
3	Fan Tach	In	FAN_TACH signal is connected to the BMC to monitor the fan speed
4	Fan PWM	Out	FAN_PWM signal to control fan speed

**Table 44. SSI 6-pin Fan Header Pin-out (J2J5, J2J6, J2J7, J2J8, J3J2 and J3J3)**

Pin	Signal Name	Type	Description
1	Ground	GND	Ground is the power supply ground
2	12V	Power	Power supply 12 V
3	Fan Tach	In	FAN_TACH signal is connected to the BMC to monitor the fan speed
4	Fan PWM	Out	FAN_PWM signal to control fan speed
5	Fan Presence	In	Indicates the fan is present
6	Fan Fault LED	Out	Lights the fan fault LED

**Note:** Intel® Corporation server boards support peripheral components and can contain a number of high-density VLSI and power delivery components that need adequate airflow to cool. Intel's own chassis are designed and tested to meet the intended thermal requirements of these components when the fully integrated system is used together. It is the responsibility of the system integrator that chooses not to use Intel® developed server building blocks to consult vendor datasheets and operating parameters to determine the amount of airflow required for their specific application and environmental conditions. Intel Corporation cannot be held responsible if components fail or the server board does not operate correctly when used outside any of its published operating or non-operating limits.

## 9. Jumper Blocks

The server board has several 3-pin jumper blocks that can be used to configure, protect, or recover specific features of the server boards.

The following symbol identifies Pin 1 on each jumper block on the silkscreen: ▼

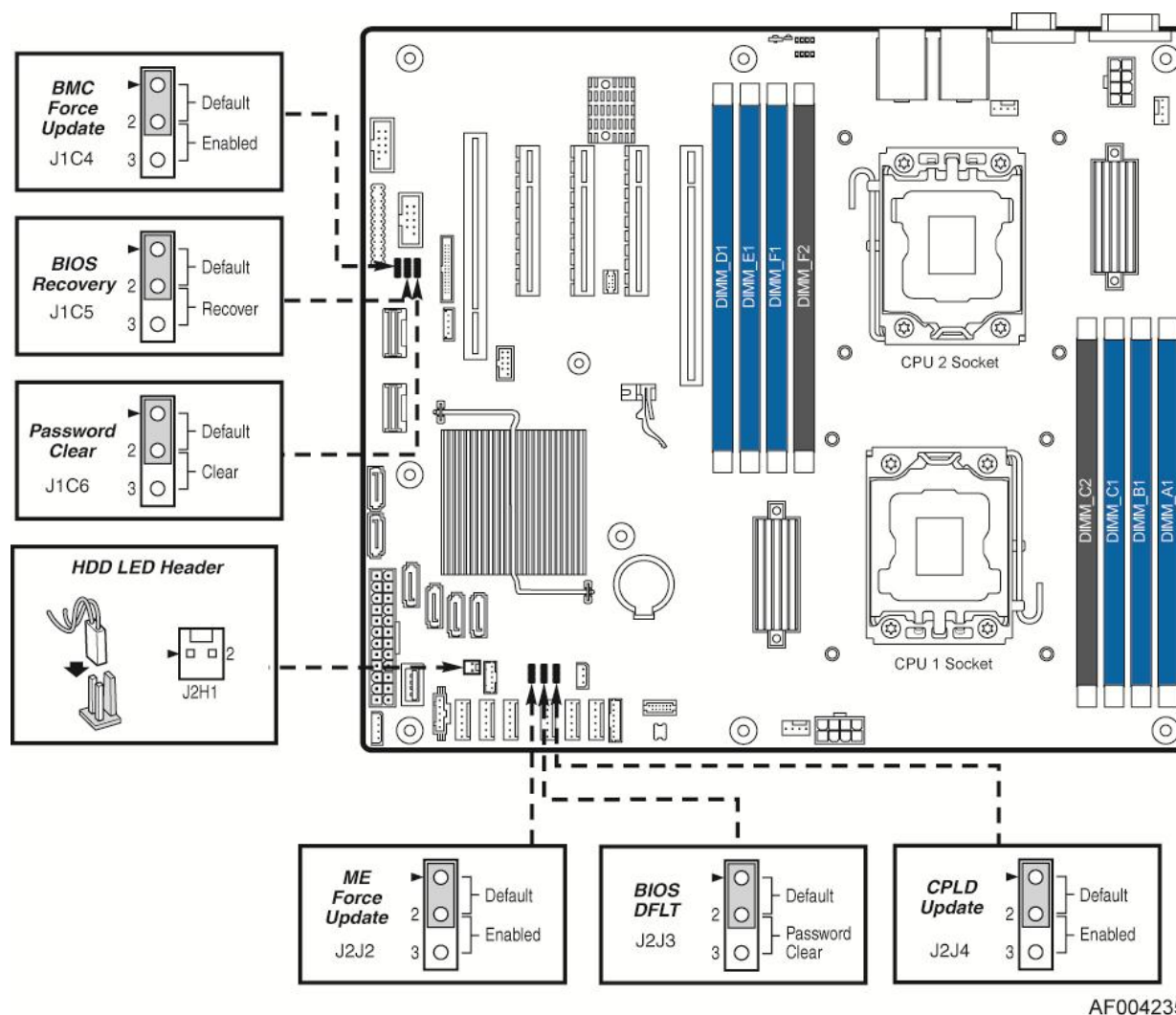

Figure 23. Jumper Blocks (J1C4, J1C5, J1C6, J2J2, J2J3, J2J4)

Table 45. Server Board Jumpers (J1C4, J1C5, J1C6, J2J2, J2J3, J2J4)

Jumper Name	Pins	System Results
J1C4: BMC Force Update	1-2	BMC Firmware Force Update Mode – Disabled ( <b>Default</b> )
	2-3	BMC Firmware Force Update Mode – Enabled
J1C5: BIOS Recovery	1-2	Pins 1-2 should be jumpered for normal system operation. ( <b>Default</b> )
	2-3	The main system BIOS does not boot with pins 2-3 jumpered. The system only boots from EFI-bootable recovery media with a recovery BIOS image present.
J2J3: BIOS Default	1-2	These pins should have a jumper in place for normal system operation. ( <b>Default</b> )
	2-3	If pins 2-3 are jumpered with AC power plugged in, the CMOS settings clear in 5 seconds.

Jumper Name	Pins	System Results
		Pins 2-3 should not be jumpered for normal system operation.
J2J2: ME Force Update	1-2	ME Firmware Force Update Mode – Disabled ( <b>Default</b> )
	2-3	ME Firmware Force Update Mode – Enabled
J1C6: Password Clear	1-2	These pins should have a jumper in place for normal system operation.
	2-3	To clear administrator and user passwords, power on the system with pins 2-3 connected. The administrator and user passwords clear in 5-10 seconds after power on. Pins 2-3 should not be connected for normal system operation.
J2J4: CPLD Update (not used)	1-2	CPLD online update disabled( <b>Default</b> )
	2-3	CPLD online update enabled

**Note:**

1. For safety purposes, the power cord should be disconnected from a system before removing any system components or moving any of the on-board jumper blocks.
2. Access to jumper blocks near Riser Slot #1 is limited, removal of the riser card may be necessary to move these jumpers.
3. System Update and Recovery files are included in the System Update Packages (SUP) posted to Intel’s web site.

## 9.1 BIOS Default (CMOS Clear) and Password Clear Usage Procedure

The BIOS default (J2J3) and Password Clear (J1C6) recovery features are designed to achieve the desired operation with minimum system down time. The usage procedure for these two features has changed from previous generation Intel® server boards. The following procedure outlines the new usage model.

### 9.1.1 Clearing CMOS (BIOS default)

1. Power down the server and unplug the AC power cord.
2. Open the server chassis. For instructions, see your server chassis documentation.
3. Move the jumper (J2J3) from the default operating position (covering pins 1 and 2) to the reset/clear position (covering pins 2 and 3).
4. Wait 5 seconds.
5. Move the jumper back to default position, covering pins 1 and 2.
6. Close the server chassis and reconnect the AC power cord.
7. Power up the server.

The CMOS is now cleared and you can reset it by going into the BIOS setup.

**Note:** Removing AC power before performing the CMOS Clear operation causes the system to

automatically power up and immediately power down after the procedure is followed and AC power is re-applied. If this happens, remove the AC power cord again, wait 30 seconds, and re-install the AC power cord. Power up the system and proceed to the <F2> BIOS Setup Utility to reset the desired settings.

### 9.1.2 Clearing the Password

1. Power down the server. Do not unplug the power cord.
2. Open the chassis. For instructions, see your server chassis documentation.
3. Move the jumper (J1C6) from the default operating position, covering pins 1 and 2, to the password clear position, covering pins 2 and 3.
4. Close the server chassis.
5. Power up the server and then press <F2> to enter the BIOS menu to check if the password is cleared.
6. Power down the server.
7. Open the chassis and move the jumper back to its default position, covering pins 1 and 2.
8. Close the server chassis.
9. Power up the server.

The password is now cleared and you can reset it by going into the BIOS setup.

## 9.2 Force BMC Update Procedure

When performing the standard Integrated BMC firmware update procedure, the update utility places the Integrated BMC into an update mode, allowing the firmware to load safely onto the flash device. In the unlikely event the Integrated BMC firmware update process fails due to the Integrated BMC not being in the proper update state, the server board provides an Integrated BMC Force Update jumper, which forces the Integrated BMC into the proper update state. The following procedure should be completed in the event the standard Integrated BMC firmware update process fails.

1. Power down and remove the AC power cord.
2. Open the server chassis. For instructions, see your server chassis documentation.
3. Move jumper from the default operating position (covering pins 1 and 2) to the enabled position (covering pins 2 and 3).
4. Close the server chassis.
5. Reconnect the AC cord and power up the server.
6. Perform the Integrated BMC firmware update procedure as documented in the README.TXT file that is included in the given Integrated BMC firmware update package.
7. After successful completion of the firmware update process, the firmware update utility may generate an error stating that the Integrated BMC is still in update mode.
8. Power down and remove the AC power cord.
9. Open the server chassis.
10. Move jumper from the enabled position (covering pins 2 and 3) to the disabled position (covering pins 1 and 2).
11. Close the server chassis.
12. Reconnect the AC cord and power up the server.

**Note:** Normal Integrated BMC functionality is disabled with the Force Integrated BMC Update

jumper set to the enabled position. The server should never be run with the Integrated BMC Force Update jumper set in this position. This jumper setting should only be used when the standard firmware update process fails. This jumper should remain in the default/disabled position when the server is running normally.

### 9.3 ME Force Update Jumper

When the ME Firmware Force Update jumper is moved from its default position, the ME is forced to operate in a reduced minimal operating capacity. This jumper should only be used if the ME firmware has gotten corrupted and requires re-installation. The following procedure should be followed.

**Note:** System Update and Recovery files are included in the System Update Packages (SUP) posted to Intel®'s web site.

1. Turn off the system and remove power cords.
2. Remove Riser Card Assembly #2.
3. Move the ME FRC UPD Jumper from the default (pins 1 and 2) operating position to the Force Update position (pins 2 and 3).
4. Re-attach system power cords.
5. Power on the system.  
**Note:** System Fans will boost and the BIOS Error Manager should report an 83A0 error code (ME in recovery mode).
6. Boot to the EFI shell and update the ME firmware using the "MEComplete####.cap" file (where #### = ME revision number) using the following command: `iflash32 /u /ni MEComplete####.cap`.
7. When update has successfully completed, power off system.
8. Remove AC power cords.
9. Move ME FRC UPD jumper back to the default position.  
**Note:** If the ME FRC UPD jumper is moved with AC power applied, the ME will not operate properly. The system will need have the AC power cords removed, wait for at least 10 seconds and then reinstalled to ensure proper operation.
10. Install the PCI Riser.
11. Install the AC power cords.
12. Power on the system.

### 9.4 BIOS Recovery Jumper

When the BIOS Recovery jumper block is moved from its default pin position, the system will boot into a BIOS Recovery Mode. It is used when the system BIOS has become corrupted and is non-functional, requiring a new BIOS image to be loaded on to the server board.

**Note:** The BIOS Recovery jumper is ONLY used to re-install a BIOS image in the event the BIOS has become corrupted. This jumper is NOT used when the BIOS is operating normally and you need to update the BIOS from one version to another.

The following procedure boots the recovery BIOS and flashes the normal BIOS:

1. Turn off the system power.
2. Move the BIOS recovery jumper to the recovery state.

3. Insert a bootable BIOS recovery media containing the new BIOS image files.
4. Turn on the system power.

The BIOS POST screen will appear displaying the progress, and the system will boot to the EFI shell. The EFI shell then executes the Startup.nsh batch file to start the flash update process.

The user should then switch off the power and return the recovery jumper to its normal position.

The user should not interrupt the BIOS POST on the first boot after recovery.

When the flash update completes:

1. Remove the recovery media.
2. Turn off the system power.
3. Restore the jumper to its original position.
4. Turn on the system power.
5. Re-flash any custom blocks, such as user binary or language blocks.

The system should now boot using the updated system BIOS.

## 10. Intel® Light Guided Diagnostics

The server board has several on-board diagnostic LEDs to assist in troubleshooting board-level issues. This section provides a description of the location and function of each LED on the server boards.

### 10.1 5 V Stand-by LED

Several server management features of these server boards require a 5 V stand-by voltage supplied from the power supply. The features and components that require this voltage that must be present when the system is “Off” include the Integrated BMC, on-board NICs, and optional Intel® RMM4/RMM4 Lite connector with Intel® RMM4/RMM4 Lite installed.

The LED is located near the main power connector on the lower left corner of the server board and is labeled “5VSB\_LED”. It is illuminated when AC power is applied to the platform and 5 V stand-by voltage is supplied to the server board by the power supply.

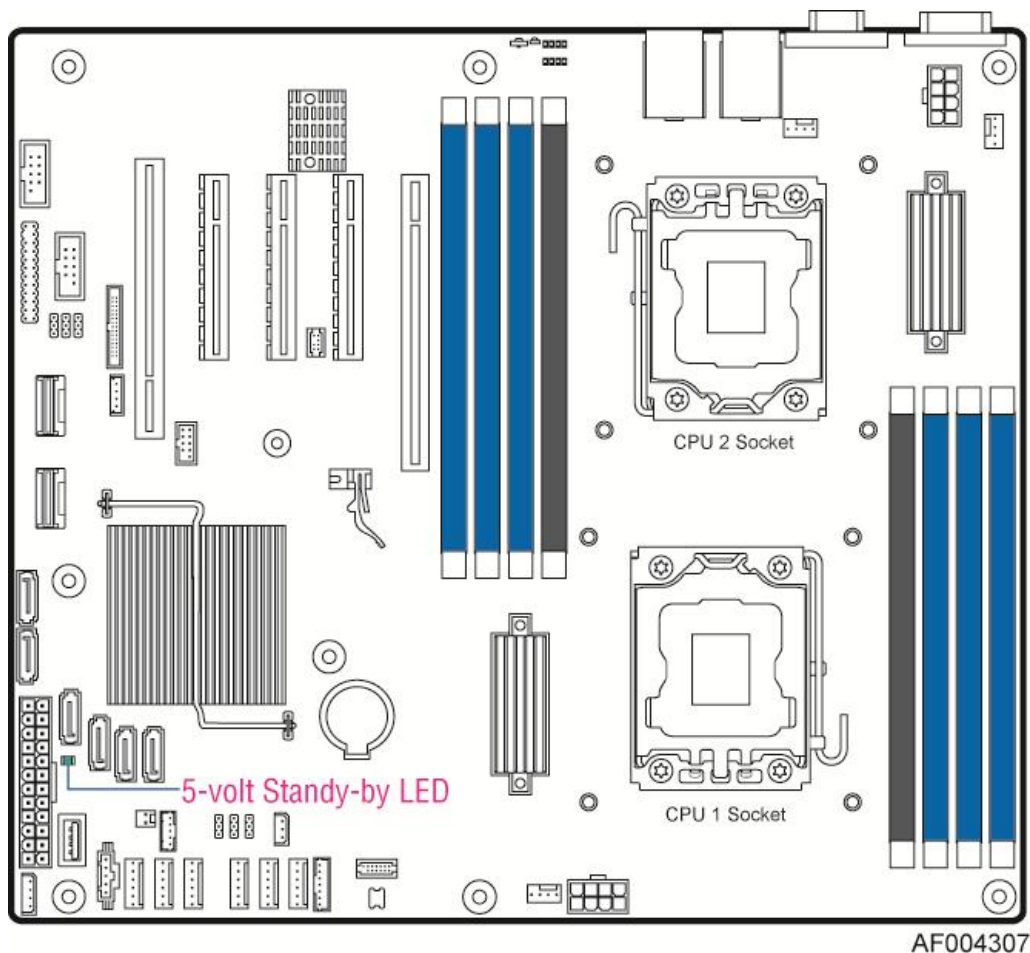
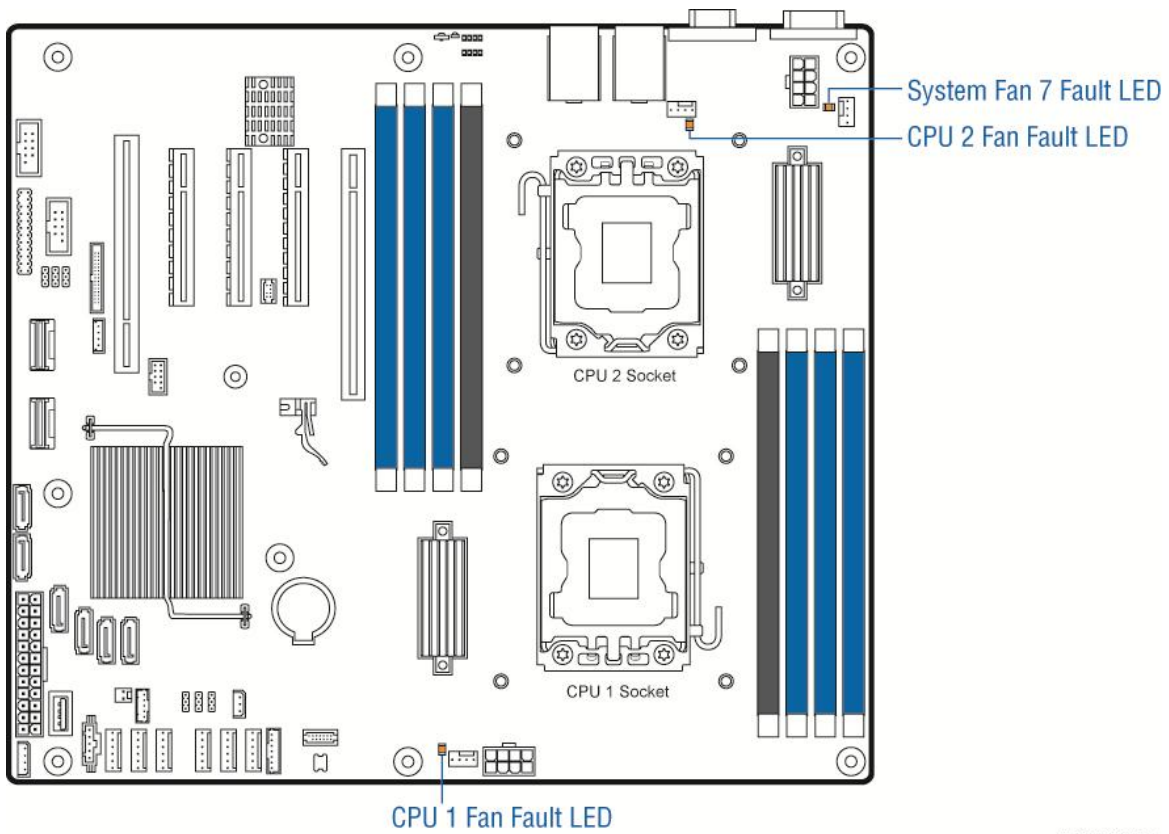

Figure 23. 5 V Stand-by Status LED Location



## 10.2 Fan Fault LEDs

Fan fault LEDs are present for the two CPU fans and are located near each CPU fan header.



AF004308

**Figure 24. Fan Fault LED Locations**

### 10.3 CPU Fault LEDs

CPU fault LEDs are present for the two CPUs and are located near each CPU fan header.

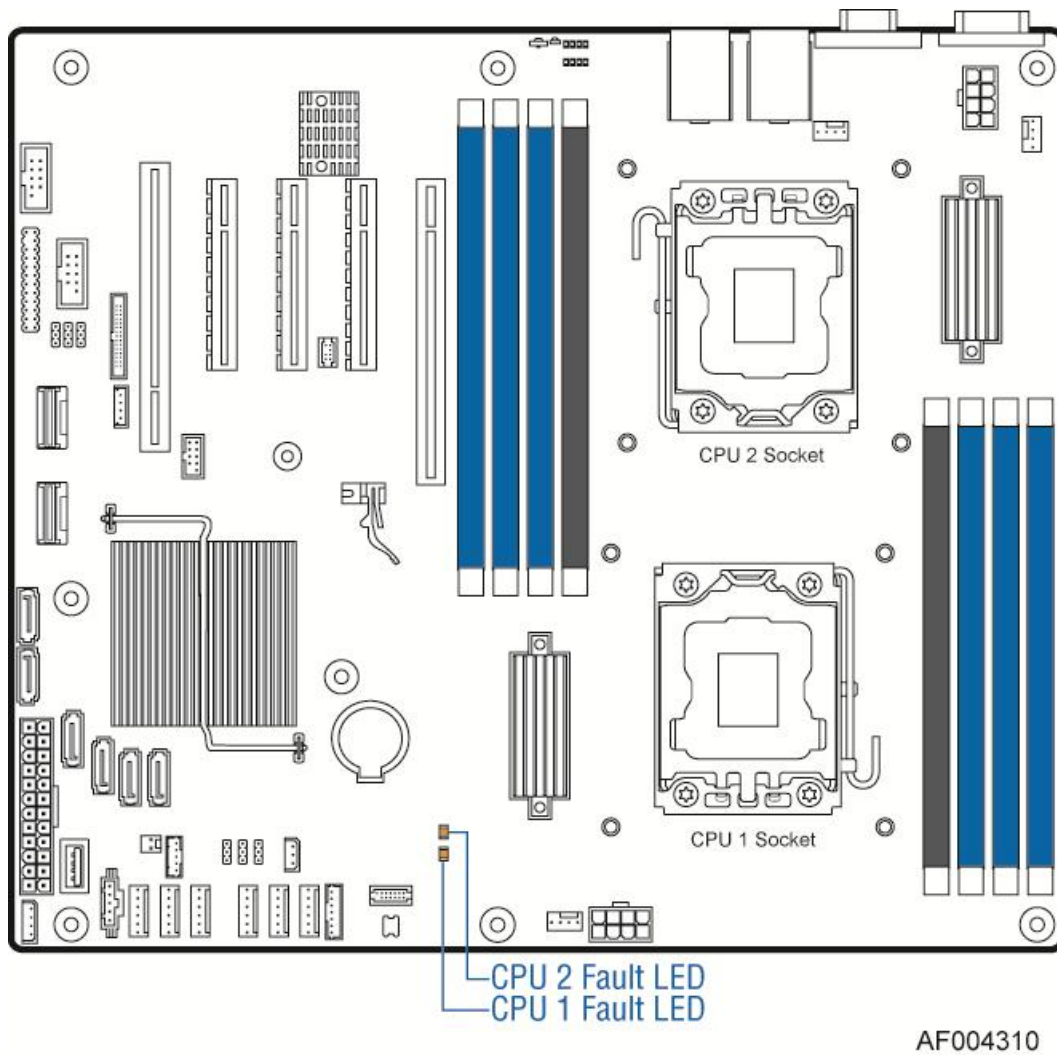
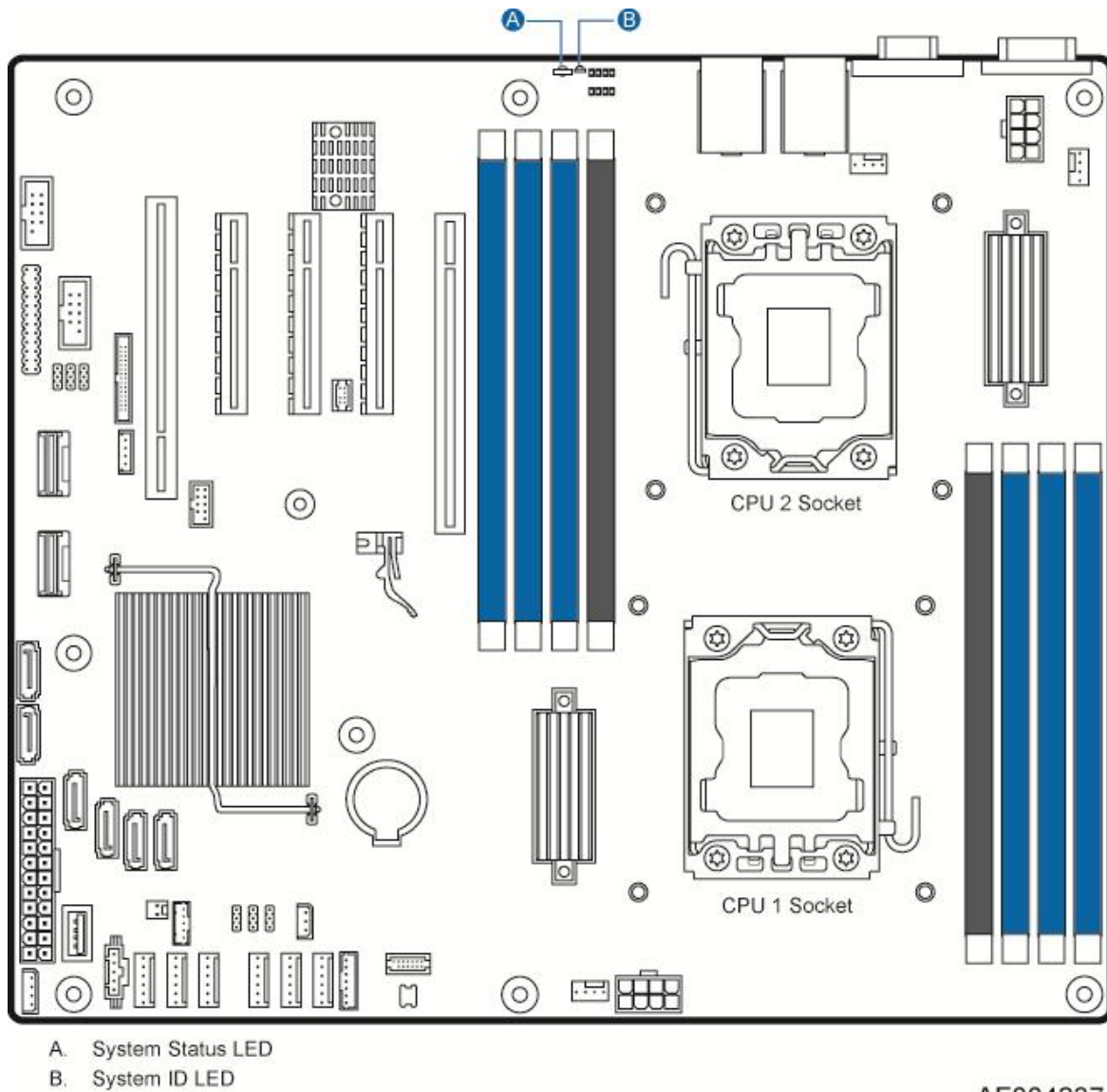

Figure 25. CPU Fault LED Locations

## 10.4 System Status LED

The server board provides a System Status LED. The following figures show the location of the LED.



AF004237

**Figure 26. System Status LED Location**

The bi-color (green/amber) System Status LED operates as follows:

**Table 46. System Status LED**

Color	State	Criticality	Description
Off	System is not operating	Not ready	<ol style="list-style-type: none"> <li>1. System is powered off (AC and/or DC).</li> <li>2. System is in EuP Lot6 Off Mode.</li> <li>3. System is in S5 Soft-Off State.</li> <li>4. System is in S4 Hibernate Sleep State.</li> </ol>
Green	Solid on	Ok	Indicates that the System is running (in S0 State) and its status is 'Healthy'. The system is not exhibiting any errors. AC power is present and BMC has booted and manageability functionality is up and running.
Green	~1 Hz blink	Degraded - system is operating in a degraded state although still functional, or system is operating in a redundant state but with an impending failure warning	<ul style="list-style-type: none"> <li>▪ System degraded:</li> <li>▪ Redundancy loss, such as power-supply or fan. Applies only if the associated platform sub-system has redundancy capabilities.</li> <li>▪ Fan warning or failure when the number of fully operational fans is more than minimum number needed to cool the system.</li> <li>▪ Non-critical threshold crossed – Temperature (including HSBP temp), voltage, input power to power supply, output current for main power rail from power supply and Processor Thermal Control (Therm Ctrl) sensors.</li> <li>▪ Power supply predictive failure occurred while redundant power supply configuration was present.</li> <li>▪ Unable to use all of the installed memory (one or more DIMMs failed/disabled but functional memory remains available)</li> <li>▪ Correctable Errors over a threshold and migrating to a spare DIMM (memory sparing). This indicates that the user no longer has spared DIMMs indicating a redundancy lost condition. Corresponding DIMM LED lit.</li> <li>▪ Uncorrectable memory error has occurred in memory Mirroring Mode, causing Loss of Redundancy.</li> <li>▪ Correctable memory error threshold has been reached for a failing DDR3 DIMM when the system is operating in fully redundant RAS Mirroring Mode.</li> <li>▪ Battery failure.</li> <li>▪ BMC executing in uBoot. (Indicated by Chassis ID blinking at Blinking at 3Hz). System in degraded state (no manageability). BMC uBoot is running but has not transferred control to BMC Linux*. Server will be in this state 6-8 seconds after BMC reset while it pulls the Linux* image into flash.</li> <li>▪ BMC booting Linux*. (Indicated by Chassis ID solid ON). System in degraded state (no manageability). Control has been passed from BMC uBoot to BMC Linux* itself. It will be in this state for ~10~20 seconds.</li> <li>▪ BMC Watchdog has reset the BMC.</li> <li>▪ Power Unit sensor offset for configuration error is asserted.</li> <li>▪ HDD HSC is off-line or degraded.</li> </ul>
Amber	~1 Hz blink	Non-critical - System is operating in a degraded state with an impending failure warning, although still functioning	<ul style="list-style-type: none"> <li>▪ Non-fatal alarm – system is likely to fail:</li> <li>▪ Critical threshold crossed – Voltage, temperature (including HSBP temp), input power to power supply, output current for main power rail from power supply and PROCHOT (Therm Ctrl) sensors.</li> <li>▪ VRD Hot asserted.</li> <li>▪ Minimum number of fans to cool the system not present or failed</li> <li>▪ Hard drive fault</li> <li>▪ Power Unit Redundancy sensor – Insufficient resources offset</li> </ul>

Color	State	Criticality	Description
			<p>(indicates not enough power supplies present)</p> <ul style="list-style-type: none"> <li>▪ In non-sparing and non-mirroring mode if the threshold of correctable errors is crossed within the window</li> <li>▪ Correctable memory error threshold has been reached for a failing DDR3 DIMM when the system is operating in a non-redundant mode</li> </ul>
Amber	Solid on	Critical, non-recoverable – System is halted	<ul style="list-style-type: none"> <li>▪ Fatal alarm – system has failed or shutdown:</li> <li>▪ CPU CATERR signal asserted</li> <li>▪ MSID mismatch detected (CATERR also asserts for this case).</li> <li>▪ CPU 1 is missing</li> <li>▪ CPU Thermal Trip</li> <li>▪ No power good – power fault</li> <li>▪ DIMM failure when there is only 1 DIMM present and hence no good memory present.</li> <li>▪ Runtime memory uncorrectable error in non-redundant mode.</li> <li>▪ DIMM Thermal Trip or equivalent</li> <li>▪ SSB Thermal Trip or equivalent</li> <li>▪ CPU ERR2 signal asserted</li> <li>▪ BMC\Video memory test failed. (Chassis ID shows blue/solid-on for this condition)</li> <li>▪ Both uBoot BMC FW images are bad. (Chassis ID shows blue/solid-on for this condition)</li> <li>▪ 240VA fault</li> <li>▪ Fatal Error in processor initialization:</li> <li>▪ Processor family not identical</li> <li>▪ Processor model not identical</li> <li>▪ Processor core/thread counts not identical</li> <li>▪ Processor cache size not identical</li> <li>▪ Unable to synchronize processor frequency</li> <li>▪ Unable to synchronize QPI link frequency</li> </ul>

## 10.5 DIMM Fault LEDs

Each DIMM slot has a DIMM Fault LED near the DIMM slot.

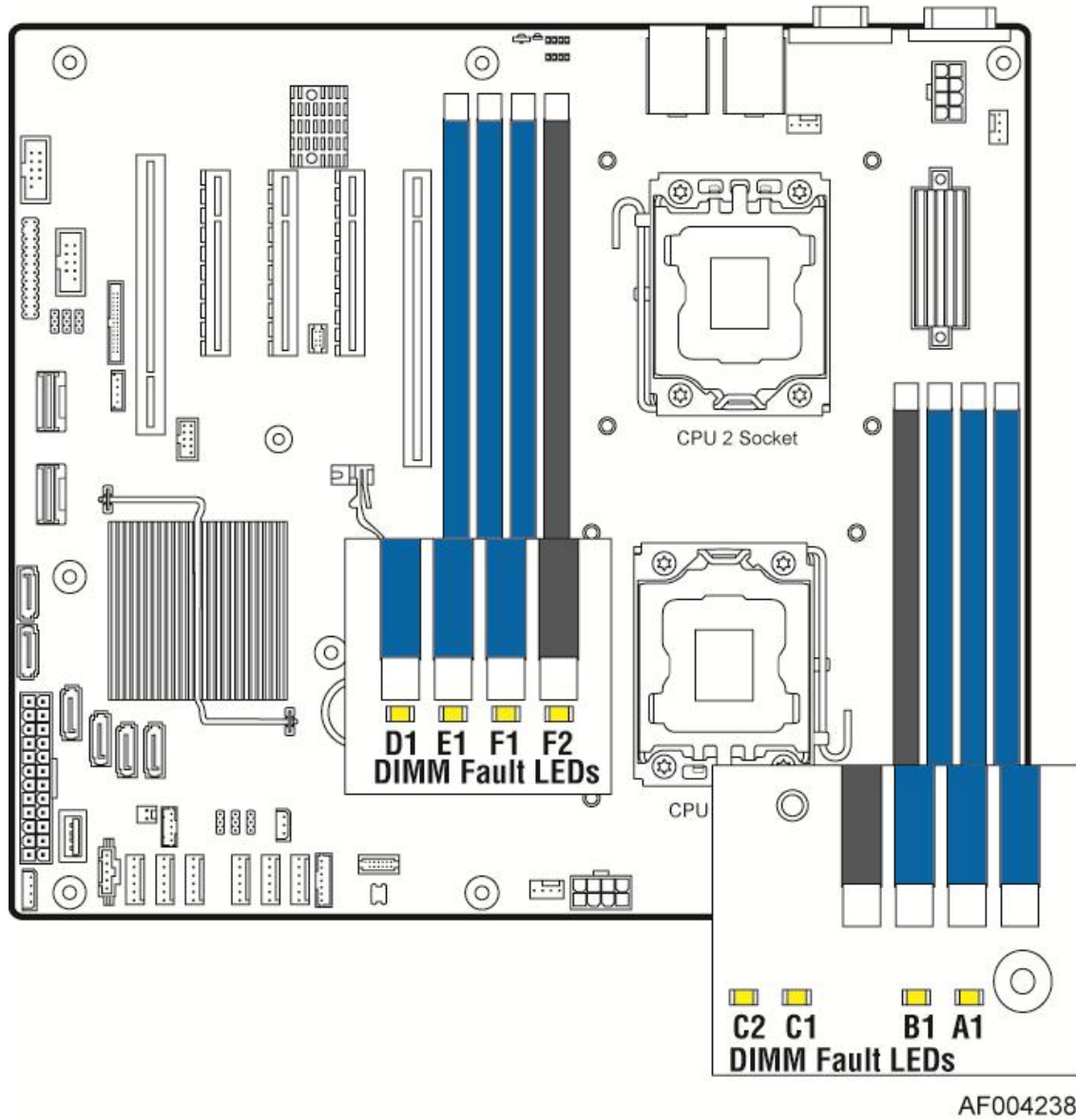

Figure 27. DIMM Fault LEDs Location

## 10.6 BMC Boot/Reset Status LED Indicators

During the BMC boot or BMC reset process, the System Status LED and System ID LED are used to indicate BMC boot process transitions and states. A BMC boot will occur when AC power is first applied to the system. A BMC reset will occur after: a BMC FW update, upon receiving a BMC cold reset command, and upon a BMC watchdog initiated reset. The following table defines the LED states during the BMC Boot/Reset process.

**Table 47. BMC Boot/Reset Status LED Indicators**

BMC Boot/Reset State	Chassis ID LED	Status LED	Comment
BMC/Video memory test failed	Solid Blue	Solid Amber	Nonrecoverable condition. Contact your Intel® representative for information on replacing this motherboard.
Both Universal Bootloader (u-Boot) images bad	Solid Blue	Solid Amber	Nonrecoverable condition. Contact your Intel® representative for information on replacing this motherboard.
BMC in u-Boot	Blink Blue 3Hz	Blink Green 1Hz	Blinking green indicates degraded state (no manageability), blinking blue indicates u-Boot is running but has not transferred control to BMC Linux*. Server will be in this state 6-8 seconds after BMC reset while it pulls the Linux* image into flash.
BMC Booting Linux*	Solid Blue	Solid Green	Solid green with solid blue after an AC cycle/BMC reset, indicates that the control has been passed from u-Boot to BMC Linux* itself. It will be in this state for ~10--20 seconds.
End of BMC boot/reset process. Normal system operation	Off	Solid Green	Indicates BMC Linux* has booted and manageability functionality is up and running. Fault/Status LEDs operate as usual.

## 10.7 Post Code Diagnostic LEDs

Eight amber POST code diagnostic LEDs are placed in two rows and located on the back edge of the server boards in the rear I/O area of the server boards by system ID LED and status LED.

During the system boot process, the BIOS executes a number of platform configuration processes, each of which is assigned a specific hex POST code number. As each configuration routine is started, the BIOS displays the given POST code to the POST code diagnostic LEDs on the back edge of the server boards. To assist in troubleshooting a system hang during the POST process, you can use the diagnostic LEDs to identify the last POST process executed. See Appendix C for a complete description of how these LEDs are read and a list of all supported POST codes.

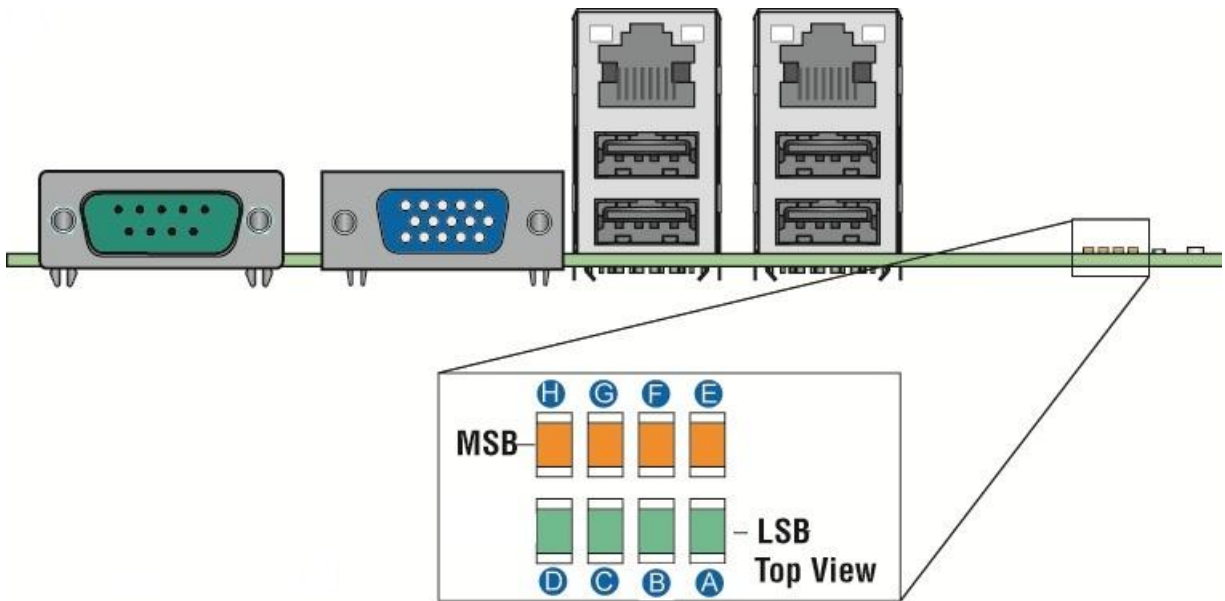

AF004309

A. Diagnostic LED #1 (LSB LED)	E. Diagnostic LED #5
B. Diagnostic LED #2	F. Diagnostic LED #6
C. Diagnostic LED #3	G. Diagnostic LED #7
D. Diagnostic LED #4	H. Diagnostic LED #8 (MSB LED)

**Figure 28. POST Code Diagnostic LED Locations**



# 11. Environmental Limits Specification

The following table defines the Intel® Server Board S2400SC operating and non-operating environmental limits. Operation of the Intel® Server Board S2400SC at conditions beyond those shown in the following table may cause permanent damage to the system. Exposure to absolute maximum rating conditions for extended periods may affect system reliability.

**Table 48. Server Board Design Specifications**

Operating Temperature	0° C to 55° C <sup>1</sup> (32° F to 131° F)
Non-Operating Temperature	-40° C to 70° C (-40° F to 158° F)
DC Voltage	± 5% of all nominal voltages
Shock (Unpackaged)	Trapezoidal, 35g, 170 inches/sec
Shock (Packaged)	
< 20 pounds	36 inches
20 to < 40 pounds	30 inches
40 to < 80 pounds	24 inches
80 to < 100 pounds	18 inches
100 to < 120 pounds	12 inches
120 pounds	9 inches
Vibration (Unpackaged)	5 Hz to 500 Hz 3.13 g RMS random

**Note:**

- Intel Corporation server boards contain a number of high-density VLSI and power delivery components that need adequate airflow to cool. Intel ensures through its own chassis development and testing that when Intel® server building blocks are used together, the fully integrated system will meet the intended thermal requirements of these components. It is the responsibility of the system integrator who chooses not to use Intel® developed server building blocks to consult vendor datasheets and operating parameters to determine the amount of airflow required for their specific application and environmental conditions. Intel Corporation cannot be held responsible, if components fail or the server board does not operate correctly when used outside any of its published operating or non-operating limits.

**Disclaimer Note:** Intel® ensures the unpackaged server board and system meet the shock requirement mentioned above through its own chassis development and system configuration. It is the responsibility of the system integrator to determine the proper shock level of the board and system if the system integrator chooses different system configuration or different chassis. Intel Corporation cannot be held responsible if components fail or the server board does not operate correctly when used outside any of its published operating or non-operating limits.

## 11.1 Processor Thermal Design Power (TDP) Support

To allow optimal operation and long-term reliability of Intel processor-based systems, the processor must remain within the defined minimum and maximum case temperature ( $T_{CASE}$ ) specifications. Thermal solutions not designed to provide sufficient thermal capability may affect the long-term reliability of the processor and system. The server board is designed to support the Intel® Xeon® Processor E5-2400 product family TDP guidelines up to and including 95W.

**Disclaimer Note:** Intel Corporation server boards contain a number of high-density VLSI and power delivery components that need adequate airflow to cool. Intel® ensures through its own chassis development and testing that when Intel server building blocks are used together, the fully integrated system will meet the intended thermal requirements of these components. It is the responsibility of the system integrator who chooses not to use Intel developed server

building blocks to consult vendor datasheets and operating parameters to determine the amount of airflow required for their specific application and environmental conditions. Intel Corporation cannot be held responsible, if components fail or the server board does not operate correctly when used outside any of their published operating or non-operating limits.

---

## 11.2 MTBF

The following is the calculated Mean Time Between Failures (MTBF) 30 degree C (ambient air). These values are derived using a historical failure rate and multiplied by factors for application, electrical and/or thermal stress and for device maturity. You should view MTBF estimates as “reference numbers” only.

- Calculate standard: Telcordia\* issue 2
- Calculate Method: Method I-D
- Temperature = 40 degree C
- Environment = GB, GC – Ground Benign, Controlled
- Model = Serial
- Duty cycle = 100%
- Component Quality: Level II
- Adhere to De-rating data

**Table 44. MTBF Estimate**

Assembly Name	Temperature (Degree C)	MTBF (hours)
Intel® Server Board S2400SC	40	168,035

## 11.3 Server Board Power Distribution

This section provides power supply design guidelines for a system using the Intel® Server Board S2400SC. The following diagram shows the power distribution implemented on this server board. For power supply data, please refer to the chapter that describes the power system options including 460W, 550W or 750W power supply. Please note the intent of 460W/550W/750W power supply data is to provide customers with a guide to assist in defining and/or selecting a power supply for custom server platform designs that utilize the server boards detailed in this document.



## Appendix A: Integration and Usage Tips

- When adding or removing components or peripherals from the server board, you must remove AC power cord. With AC power plugged into the server board, 5-V standby is still present even though the server board is powered off.
- This server board supports Intel® Xeon® Processor E5-2400 product family with a Thermal Design Power (TDP) of up to and including 95 Watts. Previous generation Intel® Xeon® processors are not supported.
- You must install processors in order. CPU 1 is located near the back edge of the server board and must be populated to operate the board.
- **The PCIe slot 3 does NOT support the Intel® PCIe gen3 ROC modules.**
- The onboard SATA connectors 0 and 1 are designed to support the ODD or SSD, do NOT connect SATA connector 0 and 1 to the backplane. The onboard SATA connectors 2-5 are designed to support the backplane.
- On the back edge of the server board are EIGHT diagnostic LEDs that display a sequence of amber POST codes during the boot process. If the server board hangs during POST, the LEDs display the last POST event run before the hang.
- Only Registered DDR3 DIMMs (RDIMMs) and Unbuffered DDR3 DIMMs (UDIMMs) are supported on this server board. Mixing of RDIMMs and UDIMMs is not supported.
- For the best performance, you should balance the number of DDR3 DIMMs installed across both processor sockets and memory channels. For example: a Two-DIMM configuration performs better than a One-DIMM configuration. In a Two-DIMM configuration, you should install DIMMs in DIMM sockets A1 and D1. A Six-DIMM configuration (DIMM Sockets A1, B1, C1, D1, E1, and F1) performs better than a Three-DIMM configuration (DIMM Sockets A1, B1, and C1).
- The Intel® RMM4/RMM4 Lite connectors are not compatible with the previous Intel® Remote Management Modules
- Clear CMOS with the AC power cord plugged in. Removing AC power before performing the CMOS Clear operation causes the system to automatically power up and immediately power down after the CMOS Clear procedure is followed and AC power is re-applied. If this happens, remove the AC power cord, wait 30 seconds, and then re-connect the AC power cord. Power up the system and proceed to the <F2> BIOS Setup Utility to reset the desired settings.
- Normal BMC functionality is disabled with the Force BMC Update jumper (J1C4) set to the “enabled” position (pins 2-3). You should never run the server with the Force BMC Update jumper set in this position and should only use the jumper in this position when the standard firmware update process fails. This jumper must remain in the default (disabled) position (pins 1-2) when the server is running normally.
- This server board no longer supports the Rolling BIOS (two BIOS banks). It implements the BIOS Recovery mechanism instead.
- When performing a normal BIOS update procedure, you must set the BIOS Recovery jumper (J1C5) to its default position (pins 1-2).

## Appendix B: Integrated BMC Sensor Tables

This appendix lists the sensor identification numbers and information about the sensor type, name, supported thresholds, assertion and de-assertion information, and a brief description of the sensor purpose. See the *Intelligent Platform Management Interface Specification, Version 2.0* for sensor and event/reading-type table information.

- **Sensor Type**

The Sensor Type is the value enumerated in the *Sensor Type Codes* table in the IPMI specification. The Sensor Type provides the context in which to interpret the sensor, such as the physical entity or characteristic represented by this sensor.

- **Event/Reading Type**

The Event/Reading Type values are from the *Event/Reading Type Code Ranges* and *Generic Event/Reading Type Codes* tables in the IPMI specification. Digital sensors are a specific type of discrete sensor with only two states.

- **Event Offset/Triggers**

Event Thresholds are event-generating thresholds for threshold type sensors.

- [u,l][nr,c,nc]: upper nonrecoverable, upper critical, upper noncritical, lower nonrecoverable, lower critical, lower noncritical
- uc, lc: upper critical, lower critical

Event Triggers are supported, event-generating offsets for discrete type sensors. You can find the offsets in the *Generic Event/Reading Type Codes* or *Sensor Type Codes* tables in the IPMI specification, depending on whether the sensor event/reading type is generic or a sensor-specific response.

- **Assertion/De-assertion Enables**

Assertion and de-assertion indicators reveal the type of events the sensor generates:

- As: Assertions
- De: De-assertion

- **Readable Value/Offsets**

- Readable Values indicate the type of value returned for threshold and other non-discrete type sensors.
- Readable Offsets indicate the offsets for discrete sensors that are readable with the *Get Sensor Reading* command. Unless indicated, all event triggers are readable; Readable Offsets consist of the reading type offsets that do not generate events.

- **Event Data**

Event data is the data included in an event message generated by the sensor. For threshold-based sensors, the following abbreviations are used:

- R: Reading value
- T: Threshold value

- **Rearm Sensors**

The rearm is a request for the event status of a sensor to be rechecked and updated upon a transition between good and bad states. You can rearm the sensors manually or automatically. This column indicates the type supported by the sensor. The following abbreviations are used in the comment column to describe a sensor:

- A: Auto-rearm
- M: Manual rearm

- **Default Hysteresis**

The hysteresis setting applies to all thresholds of the sensor. This column provides the count of hysteresis for the sensor, which is 1 or 2 (positive or negative hysteresis).

- **Criticality**

Criticality is a classification of the severity and nature of the condition. It also controls the behavior of the Control Panel Status LED.

- **Standby**

Some sensors operate on standby power. You can access these sensors and/or generate events when the main (system) power is off but AC power is present.

**Table 49. Integrated BMC Core Sensors**

Full Sensor Name (Sensor name in SDR)	Sensor #	Platform Applicability	Sensor Type	Event/Reading Type	Event Offset Triggers	Contrib. To System Status	Assert/De-assert	Readable Value/Off sets	Event Data	Rearm	Stand-by
Power Unit Status (Pwr Unit Status)	01h	All	Power Unit 09h	Sensor Specific 6Fh	00 - Power down	OK	As and De	-	Trig Offset	A	X
					02 - 240 VA power down	Fatal					
					04 - A/C lost	OK					
					05 - Soft power control failure	Fatal					
					06 - Power unit failure						
Power Unit Redundancy1 (Pwr Unit Redund)	02h	Chassis-specific	Power Unit 09h	Generic 0Bh	00 - Fully Redundant	OK	As and De	-	Trig Offset	M	X
					01 - Redundancy lost	Degraded					
					02 - Redundancy degraded	Degraded					
					03 - Non-redundant: sufficient resources. Transition from full redundant state.	Degraded					
					04 - Non-redundant: sufficient resources. Transition from insufficient state.	Degraded					
					05 - Non-redundant: insufficient resources	Fatal					
					06 - Redundant: degraded from fully redundant state.	Degraded					

Full Sensor Name (Sensor name in SDR)	Sensor #	Platform Applicability	Sensor Type	Event/Reading Type	Event Offset Triggers	Contrib. To System Status	Assert/De-assert	Readable Value/Off sets	Event Data	Rearm	Stand-by
					07 – Redundant: Transition from non-redundant state.	Degraded					
IPMI Watchdog (IPMI Watchdog)	03h	All	Watchdog 2 23h	Sensor Specific 6Fh	00 - Timer expired, status only	OK	As	–	Trig Offset	A	X
					01 - Hard reset						
					02 - Power down						
					03 - Power cycle						
					08 - Timer interrupt						
Physical Security (Physical Scrty)	04h	Chassis Intrusion is chassis-specific	Physical Security 05h	Sensor Specific 6Fh	00 - Chassis intrusion	Degraded OK	As and De	–	Trig Offset	A	X
					04 - LAN leash lost						
FP Interrupt (FP NMI Diag Int)	05h	Chassis - specific	Critical Interrupt 13h	Sensor Specific 6Fh	00 - Front panel NMI/diagnostic interrupt	OK	As	–	Trig Offset	A	–
SMI Timeout (SMI Timeout)	06h	All	SMI Timeout F3h	Digital Discrete 03h	01 – State asserted	Fatal	As and De	–	Trig Offset	A	–
System Event Log (System Event Log)	07h	All	Event Logging Disabled 10h	Sensor Specific 6Fh	02 - Log area reset/cleared	OK	As	–	Trig Offset	A	X
System Event (System Event)	08h	All	System Event 12h	Sensor Specific 6Fh	02 - Undetermined system H/W failure 04 – PEF action	Fatal OK	As and De As	-	Trig Offset	A	X
Button Sensor (Button)	09h	All	Button/Switch 14h	Sensor Specific 6Fh	00 – Power Button 02 – Reset Button	OK	AS	–	Trig Offset	A	X



Full Sensor Name (Sensor name in SDR)	Sensor #	Platform Applicability	Sensor Type	Event/Reading Type	Event Offset Triggers	Contrib. To System Status	Assert/De-assert	Readable Value/Off sets	Event Data	Rearm	Stand-by
BMC Watchdog	0Ah	All	Mgmt System Health 28h	Digital Discrete 03h	01 – State Asserted	Degraded	As	–	Trig Offset	A	-
Voltage Regulator Watchdog (VR Watchdog)	0Bh	All	Voltage 02h	Digital Discrete 03h	01 – State Asserted	Fatal	As and De	–	Trig Offset	M	X
Fan Redundancy1 (Fan Redundancy)	0Ch	Chassis-specific	Fan 04h	Generic 0Bh	00 - Fully redundant	OK	As and De	–	Trig Offset	A	–
					01 - Redundancy lost	Degraded					
					02 - Redundancy degraded	Degraded					
					03 - Non-redundant: Sufficient resources. Transition from redundant	Degraded					
					04 - Non-redundant: Sufficient resources. Transition from insufficient.	Degraded					
					05 - Non-redundant: insufficient resources.	Non-Fatal					
					06 – Non-Redundant: degraded from fully redundant.	Degraded					
					07 - Redundant degraded from non-redundant	Degraded					
SSB Thermal Trip (SSB Therm Trip)	0Dh	All	Temperature 01h	Digital Discrete 03h	01 – State Asserted	Fatal	As and De	–	Trig Offset	M	X

Full Sensor Name (Sensor name in SDR)	Sensor #	Platform Applicability	Sensor Type	Event/Reading Type	Event Offset Triggers	Contrib. To System Status	Assert/De-assert	Readable Value/Offsets	Event Data	Rearm	Stand-by
IO Module Presence (IO Mod Presence)	0Eh	Platform-specific	Module/Board 15h	Digital Discrete 08h	01 – Inserted/Present	OK	As and De	–	Trig Offset	M	-
SAS Module Presence (SAS Mod Presence)	0Fh	Platform-specific	Module/Board 15h	Digital Discrete 08h	01 – Inserted/Present	OK	As and De	–	Trig Offset	M	X
BMC Firmware Health (BMC FW Health)	10h	All	Mgmt Health 28h	Sensor Specific 6Fh	04 – Sensor Failure	Degraded	As	-	Trig Offset	A	X
System Airflow (System Airflow)	11h	All	Other Units 0Bh	Threshold 01h	–	–	–	Analog	–	–	–
FW Update Status	12h	All	Version Change 2Bh	OEM defined x70h	00h→Update started 01h→Update completed successfully. 02h→Update failure	OK	As	–	Trig Offset	A	–
IO Module2 Presence (IO Mod2 Presence)	13h	Platform-specific	Module/Board 15h	Digital Discrete 08h	01 – Inserted/Present	OK	As and De	–	Trig Offset	M	-
Baseboard Temperature 5 (Platform Specific)	14h	Platform-specific	Temperature 01h	Threshold 01h	[u,l] [c,nc]	nc = Degraded c = Non-fatal	As and De	Analog	R, T	A	X
Baseboard Temperature 6 (Platform Specific)	15h	Platform-specific	Temperature 01h	Threshold 01h	[u,l] [c,nc]	nc = Degraded c = Non-fatal	As and De	Analog	R, T	A	X
IO Module2 Temperature (I/O Mod2 Temp)	16h	Platform-specific	Temperature 01h	Threshold 01h	[u,l] [c,nc]	nc = Degraded c = Non-fatal	As and De	Analog	R, T	A	X
PCI Riser 3 Temperature (PCI Riser 5 Temp)	17h	Platform-specific	Temperature 01h	Threshold 01h	[u,l] [c,nc]	nc = Degraded c = Non-fatal	As and De	Analog	R, T	A	X

Full Sensor Name (Sensor name in SDR)	Sensor #	Platform Applicability	Sensor Type	Event/Reading Type	Event Offset Triggers	Contrib. To System Status	Assert/De-assert	Readable Value/Offsets	Event Data	Rearm	Stand-by
PCI Riser 4 Temperature (PCI Riser 4 Temp)	18h	Platform-specific	Temperature 01h	Threshold 01h	[u,l] [c,nc]	nc = Degraded c = Non-fatal	As and De	Analog	R, T	A	X
Baseboard +1.05V Processor3 Vccp (BB +1.05Vccp P3)	19h	Platform-specific	Voltage 02h	Threshold 01h	[u,l] [c,nc]	nc = Degraded c = Non-fatal	As and De	Analog	R, T	A	–
Baseboard +1.05V Processor4 Vccp (BB +1.05Vccp P4)	1Ah	Platform-specific	Voltage 02h	Threshold 01h	[u,l] [c,nc]	nc = Degraded c = Non-fatal	As and De	Analog	R, T	A	–
Baseboard Temperature 1 (Platform Specific)	20h	Platform-specific	Temperature 01h	Threshold 01h	[u,l] [c,nc]	nc = Degraded c = Non-fatal	As and De	Analog	R, T	A	X
Front Panel Temperature (Front Panel Temp)	21h	All	Temperature 01h	Threshold 01h	[u,l] [c,nc]	nc = Degraded c = Non-fatal	As and De	Analog	R, T	A	X
SSB Temperature (SSB Temp)	22h	All	Temperature 01h	Threshold 01h	[u,l] [c,nc]	nc = Degraded c = Non-fatal	As and De	Analog	R, T	A	X
Baseboard Temperature 2 (Platform Specific)	23h	Platform-specific	Temperature 01h	Threshold 01h	[u,l] [c,nc]	nc = Degraded c = Non-fatal	As and De	Analog	R, T	A	X
Baseboard Temperature 3 (Platform Specific)	24h	Platform-specific	Temperature 01h	Threshold 01h	[u,l] [c,nc]	nc = Degraded c = Non-fatal	As and De	Analog	R, T	A	X
Baseboard Temperature 4 (Platform Specific)	25h	Platform-specific	Temperature 01h	Threshold 01h	[u,l] [c,nc]	nc = Degraded c = Non-fatal	As and De	Analog	R, T	A	X
IO Module Temperature (I/O Mod Temp)	26h	Platform-specific	Temperature 01h	Threshold 01h	[u,l] [c,nc]	nc = Degraded c = Non-fatal	As and De	Analog	R, T	A	X

Full Sensor Name (Sensor name in SDR)	Sensor #	Platform Applicability	Sensor Type	Event/Reading Type	Event Offset Triggers	Contrib. To System Status	Assert/De-assert	Readable Value/Offsets	Event Data	Rearm	Stand-by
PCI Riser 1 Temperature (PCI Riser 1 Temp)	27h	Platform-specific	Temperature 01h	Threshold 01h	[u,l] [c,nc]	nc = Degraded c = Non-fatal	As and De	Analog	R, T	A	X
IO Riser Temperature (IO Riser Temp)	28h	Platform-specific	Temperature 01h	Threshold 01h	[u,l] [c,nc]	nc = Degraded c = Non-fatal	As and De	Analog	R, T	A	X
Hot-swap Backplane 1 Temperature (HSBP 1 Temp)	29h	Chassis-specific	Temperature 01h	Threshold 01h	[u,l] [c,nc]	nc = Degraded c = Non-fatal	As and De	Analog	R, T	A	X
Hot-swap Backplane 2 Temperature (HSBP 2 Temp)	2Ah	Chassis-specific	Temperature 01h	Threshold 01h	[u,l] [c,nc]	nc = Degraded c = Non-fatal	As and De	Analog	R, T	A	X
Hot-swap Backplane 3 Temperature (HSBP 3 Temp)	2Bh	Chassis-specific	Temperature 01h	Threshold 01h	[u,l] [c,nc]	nc = Degraded c = Non-fatal	As and De	Analog	R, T	A	X
PCI Riser 2 Temperature (PCI Riser 2 Temp)	2Ch	Platform-specific	Temperature 01h	Threshold 01h	[u,l] [c,nc]	nc = Degraded c = Non-fatal	As and De	Analog	R, T	A	X
SAS Module Temperature (SAS Mod Temp)	2Dh	Platform-specific	Temperature 01h	Threshold 01h	[u,l] [c,nc]	nc = Degraded c = Non-fatal	As and De	Analog	R, T	A	X
Exit Air Temperature (Exit Air Temp)	2Eh	Chassis & Platform Specific	Temperature 01h	Threshold 01h	[u,l] [c,nc]	nc = Degraded c = Non-fatal	As and De	Analog	R, T	A	X
Network Interface Controller Temperature (LAN NIC Temp)	2Fh	All	Temperature 01h	Threshold 01h	[u,l] [c,nc]	nc = Degraded c = Non-fatal	As and De	Analog	R, T	A	X
Fan Tachometer Sensors (Chassis specific sensor names)	30h– 3Fh	Chassis & Platform Specific	Fan 04h	Threshold 01h	[l] [c,nc]	nc = Degraded c = Non-fatal2	As and De	Analog	R, T	M	-

Full Sensor Name (Sensor name in SDR)	Sensor #	Platform Applicability	Sensor Type	Event/Reading Type	Event Offset Triggers	Contrib. To System Status	Assert/De-assert	Readable Value/Off sets	Event Data	Rearm	Stand-by
Fan Present Sensors (Fan x Present)	40h–4Fh	Chassis & Platform Specific	Fan 04h	Generic 08h	01 - Device inserted	OK	As and De	-	Triggered Offset	Auto	-
Power Supply 1 Status (PS1 Status)	50h	Chassis-specific	Power Supply 08h	Sensor Specific 6Fh	00 - Presence	OK	As and De	-	Trig Offset	A	X
					01 - Failure	Degraded					
					02 - Predictive Failure	Degraded					
					03 - A/C lost	Degraded					
					06 - Configuration error	OK					
Power Supply 2 Status (PS2 Status)	51h	Chassis-specific	Power Supply 08h	Sensor Specific 6Fh	00 - Presence	OK	As and De	-	Trig Offset	A	X
					01 - Failure	Degraded					
					02 - Predictive Failure	Degraded					
					03 - A/C lost	Degraded					
					06 - Configuration error	OK					
Power Supply 1 AC Power Input (PS1 Power In)	54h	Chassis-specific	Other Units 0Bh	Threshold 01h	[u] [c,nc]	nc = Degraded c = Non-fatal	As and De	Analog	R, T	A	X
Power Supply 2 AC Power Input (PS2 Power In)	55h	Chassis-specific	Other Units 0Bh	Threshold 01h	[u] [c,nc]	nc = Degraded c = Non-fatal	As and De	Analog	R, T	A	X
Power Supply 1 +12V % of Maximum Current Output (PS1 Curr Out %)	58h	Chassis-specific	Current 03h	Threshold 01h	[u] [c,nc]	nc = Degraded c = Non-fatal	As and De	Analog	R, T	A	X
Power Supply 2 +12V % of Maximum Current Output (PS2 Curr Out %)	59h	Chassis-specific	Current 03h	Threshold 01h	[u] [c,nc]	nc = Degraded c = Non-fatal	As and De	Analog	R, T	A	X
Power Supply 1 Temperature (PS1 Temperature)	5Ch	Chassis-specific	Temperature 01h	Threshold 01h	[u] [c,nc]	nc = Degraded c = Non-fatal	As and De	Analog	R, T	A	X

Full Sensor Name (Sensor name in SDR)	Sensor #	Platform Applicability	Sensor Type	Event/Reading Type	Event Offset Triggers	Contrib. To System Status	Assert/De-assert	Readable Value/Offsets	Event Data	Rearm	Stand-by
Power Supply 2 Temperature (PS2 Temperature)	5Dh	Chassis-specific	Temperature	Threshold 01h	[u] [c,nc]	nc = Degraded c = Non-fatal	As and De	Analog	R, T	A	X
Hard Disk Drive 16 - 24 Status (HDD 16 - 24 Status)	60h - 68h	Chassis-specific	Drive Slot 0Dh	Sensor Specific 6Fh	00 - Drive Presence	OK	As and De	-	Trig Offset	A	X
					01 - Drive Fault	Degraded					
					07 - Rebuild/Remap in progress	Degraded					
	69h - 6Bh	Chassis-specific	Microcontroller 16h	Discrete 0Ah	04 - transition to Off Line	Degraded					
Processor 1 Status (P1 Status)	70h	All	Processor 07h	Sensor Specific 6Fh	01 - Thermal trip	Fatal	As and De	-	Trig Offset	M	X
					07 - Presence	OK					
Processor 2 Status (P2 Status)	71h	All	Processor 07h	Sensor Specific 6Fh	01 - Thermal trip	Fatal	As and De	-	Trig Offset	M	X
					07 - Presence	OK					
Processor 3 Status (P3 Status)	72h	Platform-specific	Processor 07h	Sensor Specific 6Fh	01 - Thermal trip	Fatal	As and De	-	Trig Offset	M	X
					07 - Presence	OK					
Processor 4 Status (P4 Status)	73h	Platform-specific	Processor 07h	Sensor Specific 6Fh	01 - Thermal trip	Fatal	As and De	-	Trig Offset	M	X
					07 - Presence	OK					
Processor 1 Thermal Margin (P1 Therm Margin)	74h	All	Temperature	Threshold 01h	-	-	-	Analog	R, T	A	-

Full Sensor Name (Sensor name in SDR)	Sensor #	Platform Applicability	Sensor Type	Event/Reading Type	Event Offset Triggers	Contrib. To System Status	Assert/De-assert	Readable Value/Offsets	Event Data	Rearm	Stand-by
Processor 2 Thermal Margin (P2 Therm Margin)	75h	All	Temperature 01h	Threshold 01h	-	-	-	Analog	R, T	A	-
Processor 3 Thermal Margin (P3 Therm Margin)	76h	Platform-specific	Temperature 01h	Threshold 01h	-	-	-	Analog	R, T	A	-
Processor 4 Thermal Margin (P4 Therm Margin)	77h	Platform-specific	Temperature 01h	Threshold 01h	-	-	-	Analog	R, T	A	-
Processor 1 Thermal Control % (P1 Therm Ctrl %)	78h	All	Temperature 01h	Threshold 01h	[u] [c,nc]	nc = Degraded c = Non-fatal	As and De	Analog	Trig Offset	A	-
Processor 2 Thermal Control % (P2 Therm Ctrl %)	79h	All	Temperature 01h	Threshold 01h	[u] [c,nc]	nc = Degraded c = Non-fatal	As and De	Analog	Trig Offset	A	-
Processor 3 Thermal Control % (P3 Therm Ctrl %)	7Ah	Platform-specific	Temperature 01h	Threshold 01h	[u] [c,nc]	nc = Degraded c = Non-fatal	As and De	Analog	Trig Offset	A	-
Processor 4 Thermal Control % (P4 Therm Ctrl %)	7Bh	Platform-specific	Temperature 01h	Threshold 01h	[u] [c,nc]	nc = Degraded c = Non-fatal	As and De	Analog	Trig Offset	A	-
Processor 1 ERR2 Timeout (P1 ERR2)	7Ch	All	Processor 07h	Digital Discrete 03h	01 – State Asserted	fatal	As and De	-	Trig Offset	A	-
Processor 2 ERR2 Timeout (P2 ERR2)	7Dh	All	Processor 07h	Digital Discrete 03h	01 – State Asserted	fatal	As and De	-	Trig Offset	A	-
Processor 3 ERR2 Timeout (P3 ERR2)	7Eh	Platform-specific	Processor 07h	Digital Discrete 03h	01 – State Asserted	fatal	As and De	-	Trig Offset	A	-

Full Sensor Name (Sensor name in SDR)	Sensor #	Platform Applicability	Sensor Type	Event/Reading Type	Event Offset Triggers	Contrib. To System Status	Assert/De-assert	Readable Value/Offsets	Event Data	Rearm	Stand-by
Processor 4 ERR2 Timeout (P4 ERR2)	7Fh	Platform-specific	Processor 07h	Digital Discrete 03h	01 – State Asserted	fatal	As and De	–	Trig Offset	A	–
Catastrophic Error (CATERR)	80h	All	Processor 07h	Digital Discrete 03h	01 – State Asserted	fatal	As and De	–	Trig Offset	M	–
Processor1 MSID Mismatch (P1 MSID Mismatch)	81h	All	Processor 07h	Digital Discrete 03h	01 – State Asserted	fatal	As and De	–	Trig Offset	M	–
Processor Population Fault (CPU Missing)	82h	All	Processor 07h	Digital Discrete 03h	01 – State Asserted	Fatal	As and De	–	Trig Offset	M	–
Processor 1 DTS Thermal Margin (P1 DTS Therm Mgn)	83h	All	Temperature 01h	Threshold 01h	-	-	-	Analog	R, T	A	–
Processor 2 DTS Thermal Margin (P2 DTS Therm Mgn)	84h	All	Temperature 01h	Threshold 01h	-	-	-	Analog	R, T	A	–
Processor 3 DTS Thermal Margin (P3 DTS Therm Mgn)	85h	All	Temperature 01h	Threshold 01h	-	-	-	Analog	R, T	A	–
Processor 4 DTS Thermal Margin (P4 DTS Therm Mgn)	86h	All	Temperature 01h	Threshold 01h	-	-	-	Analog	R, T	A	–
Processor2 MSID Mismatch (P2 MSID Mismatch)	87h	All	Processor 07h	Digital Discrete 03h	01 – State Asserted	fatal	As and De	–	Trig Offset	M	–
Processor 1 VRD Temperature (P1 VRD Hot)	90h	All	Temperature 01h	Digital Discrete 05h	01 - Limit exceeded	Non-fatal	As and De	–	Trig Offset	M	–



Full Sensor Name (Sensor name in SDR)	Sensor #	Platform Applicability	Sensor Type	Event/Reading Type	Event Offset Triggers	Contrib. To System Status	Assert/De-assert	Readable Value/Offsets	Event Data	Rearm	Stand-by
Processor 2 VRD Temperature (P2 VRD Hot)	91h	All	Temperature	Digital Discrete 01h 05h	01 - Limit exceeded	Non-fatal	As and De	–	Trig Offset	M	–
Processor 3 VRD Temperature (P3 VRD Hot)	92h	All	Temperature	Digital Discrete 01h 05h	01 - Limit exceeded	Fatal	As and De	–	Trig Offset	M	–
Processor 4 VRD Temperature (P4 VRD Hot)	93h	All	Temperature	Digital Discrete 01h 05h	01 - Limit exceeded	Fatal	As and De	–	Trig Offset	M	–
Processor 1 Memory VRD Hot 0-1 (P1 Mem01 VRD Hot)	94h	All	Temperature	Digital Discrete 01h 05h	01 - Limit exceeded	Non-fatal	As and De	–	Trig Offset	A	–
Processor 1 Memory VRD Hot 2-3 (P1 Mem23 VRD Hot)	95h	All	Temperature	Digital Discrete 01h 05h	01 - Limit exceeded	Non-fatal	As and De	–	Trig Offset	A	–
Processor 2 Memory VRD Hot 0-1 (P2 Mem01 VRD Hot)	96h	All	Temperature	Digital Discrete 01h 05h	01 - Limit exceeded	Non-fatal	As and De	–	Trig Offset	A	–
Processor 2 Memory VRD Hot 2-3 (P2 Mem23 VRD Hot)	97h	All	Temperature	Digital Discrete 01h 05h	01 - Limit exceeded	Non-fatal	As and De	–	Trig Offset	A	–
Processor 3 Memory VRD Hot 0-1 (P3 Mem01 VRD Hot)	98h	All	Temperature	Digital Discrete 01h 05h	01 - Limit exceeded	Non-fatal	As and De	–	Trig Offset	A	–
Processor 3 Memory VRD Hot 2-3 (P4 Mem23 VRD Hot)	99h	All	Temperature	Digital Discrete 01h 05h	01 - Limit exceeded	Non-fatal	As and De	–	Trig Offset	A	–
Processor 4 Memory VRD Hot 0-1 (P4 Mem01 VRD Hot)	9Ah	All	Temperature	Digital Discrete 01h 05h	01 - Limit exceeded	Non-fatal	As and De	–	Trig Offset	A	–

Full Sensor Name (Sensor name in SDR)	Sensor #	Platform Applicability	Sensor Type	Event/Reading Type	Event Offset Triggers	Contrib. To System Status	Assert/De-assert	Readable Value/Offsets	Event Data	Rearm	Stand-by	
Processor 4 Memory VRD Hot 2-3 (P4 Mem23 VRD Hot)	9Bh	All	Temperature	Digital Discrete	01h	01 - Limit exceeded	Non-fatal	As and De	-	Trig Offset	A	-
Power Supply 1 Fan Tachometer 1 (PS1 Fan Tach 1)	A0h	Chassis-specific	Fan	Generic – digital discrete	04h	01 – State Asserted	Non-fatal	As and De	-	Trig Offset	M	-
Power Supply 1 Fan Tachometer 2 (PS1 Fan Tach 2)	A1h	Chassis-specific	Fan	Generic – digital discrete	04h	01 – State Asserted	Non-fatal	As and De	-	Trig Offset	M	-
Power Supply 2 Fan Tachometer 1 (PS2 Fan Tach 1)	A4h	Chassis-specific	Fan	Generic – digital discrete	04h	01 – State Asserted	Non-fatal	As and De	-	Trig Offset	M	-
Power Supply 2 Fan Tachometer 2 (PS2 Fan Tach 2)	A5h	Chassis-specific	Fan	Generic – digital discrete	04h	01 – State Asserted	Non-fatal	As and De	-	Trig Offset	M	-
Processor 1 DIMM Aggregate Thermal Margin 1 (P1 DIMM Thrm Mrgn1)	B0h	All	Temperature	Threshold	01h	[u,l] [c,nc]	nc = Degraded c = Non-fatal	As and De	Analog	R, T	A	-
Processor 1 DIMM Aggregate Thermal Margin 2 (P1 DIMM Thrm Mrgn2)	B1h	All	Temperature	Threshold	01h	[u,l] [c,nc]	nc = Degraded c = Non-fatal	As and De	Analog	R, T	A	-
Processor 2 DIMM Aggregate Thermal Margin 1 (P2 DIMM Thrm Mrgn1)	B2h	All	Temperature	Threshold	01h	[u,l] [c,nc]	nc = Degraded c = Non-fatal	As and De	Analog	R, T	A	-
Processor 2 DIMM Aggregate Thermal Margin 2 (P2 DIMM Thrm Mrgn2)	B3h	All	Temperature	Threshold	01h	[u,l] [c,nc]	nc = Degraded c = Non-fatal	As and De	Analog	R, T	A	-
Processor 3 DIMM Aggregate Thermal Margin 1 (P3 DIMM Thrm Mrgn1)	B4h	Platform Specific	Temperature	Threshold	01h	[u,l] [c,nc]	nc = Degraded c = Non-fatal	As and De	Analog	R, T	A	-

Full Sensor Name (Sensor name in SDR)	Sensor #	Platform Applicability	Sensor Type	Event/Reading Type	Event Offset Triggers	Contrib. To System Status	Assert/De-assert	Readable Value/Offsets	Event Data	Rearm	Stand-by
Processor 3 DIMM Aggregate Thermal Margin 2 (P3 DIMM Thrm Mrgn2)	B5h	Platform Specific	Temperature 01h	Threshold 01h	[u,l] [c,nc]	nc = Degraded c = Non-fatal	As and De	Analog	R, T	A	-
Processor 4 DIMM Aggregate Thermal Margin 1 (P4 DIMM Thrm Mrgn1)	B6h	Platform Specific	Temperature 01h	Threshold 01h	[u,l] [c,nc]	nc = Degraded c = Non-fatal	As and De	Analog	R, T	A	-
Processor 4 DIMM Aggregate Thermal Margin 2 (P4 DIMM Thrm Mrgn2)	B7h	Platform Specific	Temperature 01h	Threshold 01h	[u,l] [c,nc]	nc = Degraded c = Non-fatal	As and De	Analog	R, T	A	-
Fan Tachometer Sensors (Chassis specific sensor names)	BAh–BFh	Chassis & Platform Specific	Fan 04h	Threshold 01h	[l] [c,nc]	nc = Degraded c = Non-fatal2	As and De	Analog	R, T	M	-
Processor 1 DIMM Thermal Trip (P1 Mem Thrm Trip)	C0h	All	Memory 0Ch	Digital Discrete 03h	0A- Critical overtemperature	Fatal	As and De	-	Trig Offset	M	-
Processor 2 DIMM Thermal Trip (P2 Mem Thrm Trip)	C1h	All	Memory 0Ch	Digital Discrete 03h	0A- Critical over temperature	Fatal	As and De	-	Trig Offset	M	-
Processor 3 DIMM Thermal Trip (P3 Mem Thrm Trip)	C2h	All	Memory 0Ch	Digital Discrete 03h	0A- Critical overtemperature	Fatal	As and De	-	Trig Offset	M	X
Processor 4 DIMM Thermal Trip (P4 Mem Thrm Trip)	C3h	All	Memory 0Ch	Digital Discrete 03h	0A- Critical overtemperature	Fatal	As and De	-	Trig Offset	M	X
Global Aggregate Temperature Margin 1 (Agg Therm Mrgn 1)	C8h	Platform Specific	Temperature 01h	Threshold 01h	-	-	-	Analog	R, T	A	-
Global Aggregate Temperature Margin 2 (Agg Therm Mrgn 2)	C9h	Platform Specific	Temperature 01h	Threshold 01h	-	-	-	Analog	R, T	A	-

Full Sensor Name (Sensor name in SDR)	Sensor #	Platform Applicability	Sensor Type	Event/Reading Type	Event Offset Triggers	Contrib. To System Status	Assert/De-assert	Readable Value/Offsets	Event Data	Rearm	Stand-by
Global Aggregate Temperature Margin 3 (Agg Therm Mrgn 3)	CAh	Platform Specific	Temperature 01h	Threshold 01h	-	-	-	Analog	R, T	A	-
Global Aggregate Temperature Margin 4 (Agg Therm Mrgn 4)	CBh	Platform Specific	Temperature 01h	Threshold 01h	-	-	-	Analog	R, T	A	-
Global Aggregate Temperature Margin 5 (Agg Therm Mrgn 5)	CCh	Platform Specific	Temperature 01h	Threshold 01h	-	-	-	Analog	R, T	A	-
Global Aggregate Temperature Margin 6 (Agg Therm Mrgn 6)	CDh	Platform Specific	Temperature 01h	Threshold 01h	-	-	-	Analog	R, T	A	-
Global Aggregate Temperature Margin 7 (Agg Therm Mrgn 7)	CEh	Platform Specific	Temperature 01h	Threshold 01h	-	-	-	Analog	R, T	A	-
Global Aggregate Temperature Margin 8 (Agg Therm Mrgn 8)	CFh	Platform Specific	Temperature 01h	Threshold 01h	-	-	-	Analog	R, T	A	-
Baseboard +12V (BB +12.0V)	D0h	All	Voltage 02h	Threshold 01h	[u,l] [c,nc]	nc = Degraded c = Non-fatal	As and De	Analog	R, T	A	-
Baseboard +5V (BB +5.0V)	D1h	All	Voltage 02h	Threshold 01h	[u,l] [c,nc]	nc = Degraded c = Non-fatal	As and De	Analog	R, T	A	-
Baseboard +3.3V (BB +3.3V)	D2h	All	Voltage 02h	Threshold 01h	[u,l] [c,nc]	nc = Degraded c = Non-fatal	As and De	Analog	R, T	A	-
Baseboard +5V Stand-by (BB +5.0V STBY)	D3h	All	Voltage 02h	Threshold 01h	[u,l] [c,nc]	nc = Degraded c = Non-fatal	As and De	Analog	R, T	A	X

Full Sensor Name (Sensor name in SDR)	Sensor #	Platform Applicability	Sensor Type	Event/Reading Type	Event Offset Triggers	Contrib. To System Status	Assert/De-assert	Readable Value/Offsets	Event Data	Rearm	Stand-by
Baseboard +3.3V Auxiliary (BB +3.3V AUX)	D4h	All	Voltage 02h	Threshold 01h	[u,l] [c,nc]	nc = Degraded c = Non-fatal	As and De	Analog	R, T	A	X
Baseboard +1.05V Processor1 Vccp (BB +1.05Vccp P1)	D6h	All	Voltage 02h	Threshold 01h	[u,l] [c,nc]	nc = Degraded c = Non-fatal	As and De	Analog	R, T	A	–
Baseboard +1.05V Processor2 Vccp (BB +1.05Vccp P2)	D7h	All	Voltage 02h	Threshold 01h	[u,l] [c,nc]	nc = Degraded c = Non-fatal	As and De	Analog	R, T	A	–
Baseboard +1.5V P1 Memory AB VDDQ (BB +1.5 P1MEM AB)	D8h	All	Voltage 02h	Threshold 01h	[u,l] [c,nc]	nc = Degraded c = Non-fatal	As and De	Analog	R, T	A	–
Baseboard +1.5V P1 Memory CD VDDQ (BB +1.5 P1MEM CD)	D9h	All	Voltage 02h	Threshold 01h	[u,l] [c,nc]	nc = Degraded c = Non-fatal	As and De	Analog	R, T	A	–
Baseboard +1.5V P2 Memory AB VDDQ (BB +1.5 P2MEM AB)	DAh	All	Voltage 02h	Threshold 01h	[u,l] [c,nc]	nc = Degraded c = Non-fatal	As and De	Analog	R, T	A	–
Baseboard +1.5V P2 Memory CD VDDQ (BB +1.5 P2MEM CD)	DBh	All	Voltage 02h	Threshold 01h	[u,l] [c,nc]	nc = Degraded c = Non-fatal	As and De	Analog	R, T	A	–
Baseboard +1.8V Aux (BB +1.8V AUX)	DCh	All	Voltage 02h	Threshold 01h	[u,l] [c,nc]	nc = Degraded c = Non-fatal	As and De	Analog	R, T	A	–
Baseboard +1.1V Stand-by (BB +1.1V STBY)	DDh	All	Voltage 02h	Threshold 01h	[u,l] [c,nc]	nc = Degraded c = Non-fatal	As and De	Analog	R, T	A	–
Baseboard CMOS Battery (BB +3.3V Vbat)	DEh	All	Voltage 02h	Threshold 01h	[u,l] [c,nc]	nc = Degraded c = Non-fatal	As and De	Analog	R, T	A	–

Full Sensor Name (Sensor name in SDR)	Sensor #	Platform Applicability	Sensor Type	Event/Reading Type	Event Offset Triggers	Contrib. To System Status	Assert/De-assert	Readable Value/Offsets	Event Data	Rearm	Stand-by
Baseboard +1.35V P1 Low Voltage Memory AB VDDQ (BB +1.35 P1LV AB)	E4h	All	Voltage 02h	Threshold 01h	[u,l] [c,nc]	nc = Degraded c = Non-fatal	As and De	Analog	R, T	A	-
Baseboard +1.35V P1 Low Voltage Memory CD VDDQ (BB +1.35 P1LV CD)	E5h	All	Voltage 02h	Threshold 01h	[u,l] [c,nc]	nc = Degraded c = Non-fatal	As and De	Analog	R, T	A	-
Baseboard +1.35V P2 Low Voltage Memory AB VDDQ (BB +1.35 P2LV AB)	E6h	All	Voltage 02h	Threshold 01h	[u,l] [c,nc]	nc = Degraded c = Non-fatal	As and De	Analog	R, T	A	-
Baseboard +1.35V P2 Low Voltage Memory CD VDDQ (BB +1.35 P2LV CD)	E7h	All	Voltage 02h	Threshold 01h	[u,l] [c,nc]	nc = Degraded c = Non-fatal	As and De	Analog	R, T	A	-
Baseboard +3.3V Riser 1 Power Good (BB +3.3 RSR1 PGD)	EAh	Platform Specific	Voltage 02h	Threshold 01h	[u,l] [c,nc]	nc = Degraded c = Non-fatal	As and De	Analog	R, T	A	-
Baseboard +3.3V Riser 2 Power Good (BB +3.3 RSR2 PGD)	EBh	Platform Specific	Voltage 02h	Threshold 01h	[u,l] [c,nc]	nc = Degraded c = Non-fatal	As and De	Analog	R, T	A	-
Hard Disk Drive 1 -15 Status (HDD 1 - 15 Status)	F0h - FEh	Chassis-specific	Drive Slot 0Dh	Sensor Specific 6Fh	00 - Drive Presence	OK	As and De	-	Trig Offset	A	X
					01 - Drive Fault	Degraded					
					07 - Rebuild/Remap in progress	Degraded					

**Notes:**

1. Redundancy sensors will be only present on systems with appropriate hardware to support redundancy (for instance, fan or power supply).
2. This is only applicable when the system doesn't support redundant fans. When fan redundancy is supported, then the contribution to system state is driven by the fan redundancy sensor.

## Appendix C: POST Code Diagnostic LED Decoder

As an aid to assist in trouble shooting a system hang that occurs during a system's Power-On Self Test (POST) process, the server board includes a bank of eight POST Code Diagnostic LEDs on the back edge of the server board.

During the system boot process, Memory Reference Code (MRC) and System BIOS execute a number of memory initialization and platform configuration processes, each of which is assigned a specific hex POST code number. As each routine is started, the given POST code number is displayed to the POST Code Diagnostic LEDs on the back edge of the server board.

During a POST system hang, the displayed post code can be used to identify the last POST routine that was run prior to the error occurring, helping to isolate the possible cause of the hang condition.

Each POST code is represented by eight LEDs; four Green and four Amber. The POST codes are divided into two nibbles, an upper nibble and a lower nibble. The upper nibble bits are represented by Amber Diagnostic LEDs #4, #5, #6, #7. The lower nibble bits are represented by Green Diagnostics LEDs #0, #1, #2 and #3. If the bit is set in the upper and lower nibbles, the corresponding LED is lit. If the bit is clear, the corresponding LED is off.

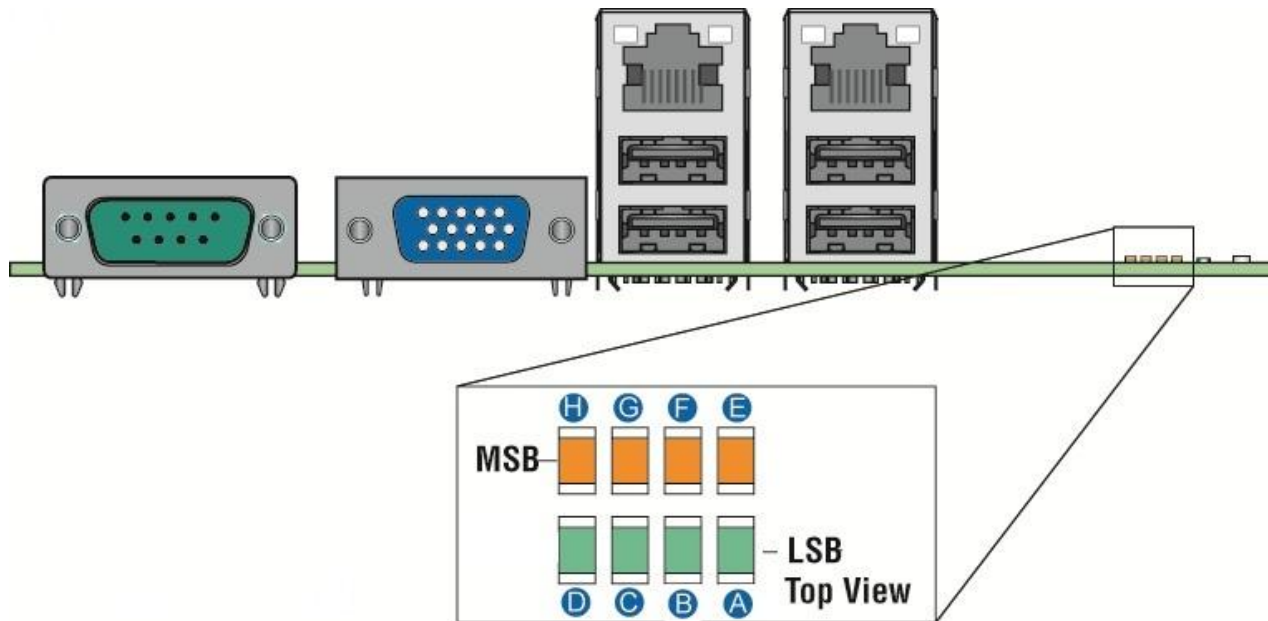

AF004309

A. Diagnostic LED #1(LSB LED)	E. Diagnostic LED #5
B. Diagnostic LED #2	F. Diagnostic LED #6
C. Diagnostic LED #3	G. Diagnostic LED #7
D. Diagnostic LED #4	H. Diagnostic LED #8 (MSB LED)

In the following example, the BIOS sends a value of ACh to the diagnostic LED decoder. The LEDs are decoded as follows:

**Note:** Diag LEDs are best read and decoded when viewing the LEDs from the back of the system

**Table 50. POST Progress Code LED Example**

LEDs	Upper Nibble AMBER LEDs				Lower Nibble GREEN LEDs			
	MSB							LSB
	LED #7	LED #6	LED #5	LED #4	LED #3	LED #2	LED #1	LED #0
	8h	4h	2h	1h	8h	4h	2h	1h
Status	ON	OFF	ON	OFF	ON	ON	OFF	OFF
Results	1	0	1	0	1	1	0	0
	<b>Ah</b>				<b>Ch</b>			

Upper nibble bits = 1010b = Ah; Lower nibble bits = 1100b = Ch; the two are concatenated as ACh

The following table provides a list of all POST progress codes.

**Table 51. POST Progress Codes**

Checkpoint	Diagnostic LED Decoder								Description
	1 = LED On, 0 = LED Off								
	Upper Nibble				Lower Nibble				
	MSB							LSB	
LED #	#7	#6	#5	#4	#3	#2	#1	#0	
<b>SEC Phase</b>									
01h	0	0	0	0	0	0	0	1	First POST code after CPU reset
02h	0	0	0	0	0	0	1	0	Microcode load begin
03h	0	0	0	0	0	0	1	1	CRAM initialization begin
04h	0	0	0	0	0	1	0	0	Pei Cache When Disabled
05h	0	0	0	0	0	1	0	1	SEC Core At Power On Begin.
06h	0	0	0	0	0	1	1	0	Early CPU initialization during Sec Phase.
07h	0	0	0	0	0	1	1	1	Early SB initialization during Sec Phase.
08h	0	0	0	0	1	0	0	0	Early NB initialization during Sec Phase.
09h	0	0	0	0	1	0	0	1	End Of Sec Phase.
0Eh	0	0	0	0	1	1	1	0	Microcode Not Found.
0Fh	0	0	0	0	1	1	1	1	Microcode Not Loaded.
<b>PEI Phase</b>									
10h	0	0	0	1	0	0	0	0	PEI Core
11h	0	0	0	1	0	0	0	1	CPU PEIM
15h	0	0	0	1	0	1	0	1	NB PEIM
19h	0	0	0	1	1	0	0	1	SB PEIM
<b>MRC Process Codes – MRC Progress Code Sequence is executed - See Table 63</b>									
<b>PEI Phase continued...</b>									
31h	0	0	1	1	0	0	0	1	Memory Installed
32h	0	0	1	1	0	0	1	0	CPU PEIM (Cpu Init)
33h	0	0	1	1	0	0	1	1	CPU PEIM (Cache Init)
34h	0	0	1	1	0	1	0	0	CPU PEIM (BSP Select)
35h	0	0	1	1	0	1	0	1	CPU PEIM (AP Init)
36h	0	0	1	1	0	1	1	0	CPU PEIM (CPU SMM Init)
4Fh	0	1	0	0	1	1	1	1	Dxe IPL started
<b>DXE Phase</b>									
60h	0	1	1	0	0	0	0	0	DXE Core started
61h	0	1	1	0	0	0	0	1	DXE NVRAM Init
62h	0	1	1	0	0	0	1	0	SB RUN Init
63h	0	1	1	0	0	0	1	1	Dxe CPU Init
68h	0	1	1	0	1	0	0	0	DXE PCI Host Bridge Init
69h	0	1	1	0	1	0	0	1	DXE NB Init
6Ah	0	1	1	0	1	0	1	0	DXE NB SMM Init



Checkpoint	Diagnostic LED Decoder								Description
	1 = LED On, 0 = LED Off								
	Upper Nibble				Lower Nibble				
	MSB							LSB	
LED #	#7	#6	#5	#4	#3	#2	#1	#0	
70h	0	1	1	1	0	0	0	0	DXE SB Init
71h	0	1	1	1	0	0	0	1	DXE SB SMM Init
72h	0	1	1	1	0	0	1	0	DXE SB devices Init
78h	0	1	1	1	1	0	0	0	DXE ACPI Init
79h	0	1	1	1	1	0	0	1	DXE CSM Init
90h	1	0	0	1	0	0	0	0	DXE BDS Started
91h	1	0	0	1	0	0	0	1	DXE BDS connect drivers
92h	1	0	0	1	0	0	1	0	DXE PCI Bus begin
93h	1	0	0	1	0	0	1	1	DXE PCI Bus HPC Init
94h	1	0	0	1	0	1	0	0	DXE PCI Bus enumeration
95h	1	0	0	1	0	1	0	1	DXE PCI Bus resource requested
96h	1	0	0	1	0	1	1	0	DXE PCI Bus assign resource
97h	1	0	0	1	0	1	1	1	DXE CON_OUT connect
98h	1	0	0	1	1	0	0	0	DXE CON_IN connect
99h	1	0	0	1	1	0	0	1	DXE SIO Init
9Ah	1	0	0	1	1	0	1	0	DXE USB start
9Bh	1	0	0	1	1	0	1	1	DXE USB reset
9Ch	1	0	0	1	1	1	0	0	DXE USB detect
9Dh	1	0	0	1	1	1	0	1	DXE USB enable
A1h	1	0	1	0	0	0	0	1	DXE IDE begin
A2h	1	0	1	0	0	0	1	0	DXE IDE reset
A3h	1	0	1	0	0	0	1	1	DXE IDE detect
A4h	1	0	1	0	0	1	0	0	DXE IDE enable
A5h	1	0	1	0	0	1	0	1	DXE SCSI begin
A6h	1	0	1	0	0	1	1	0	DXE SCSI reset
A7h	1	0	1	0	0	1	1	1	DXE SCSI detect
A8h	1	0	1	0	1	0	0	0	DXE SCSI enable
A9h	1	0	1	0	1	0	0	1	DXE verifying SETUP password
ABh	1	0	1	0	1	0	1	1	DXE SETUP start
ACh	1	0	1	0	1	1	0	0	DXE SETUP input wait
ADh	1	0	1	0	1	1	0	1	DXE Ready to Boot
A Eh	1	0	1	0	1	1	1	0	DXE Legacy Boot
AFh	1	0	1	0	1	1	1	1	DXE Exit Boot Services
B0h	1	0	1	1	0	0	0	0	RT Set Virtual Address Map Begin
B1h	1	0	1	1	0	0	0	1	RT Set Virtual Address Map End
B2h	1	0	1	1	0	0	1	0	DXE Legacy Option ROM init
B3h	1	0	1	1	0	0	1	1	DXE Reset system
B4h	1	0	1	1	0	1	0	0	DXE USB Hot plug
B5h	1	0	1	1	0	1	0	1	DXE PCI BUS Hot plug
B6h	1	0	1	1	0	1	1	0	DXE NVRAM cleanup
B7h	1	0	1	1	0	1	1	1	DXE Configuration Reset
00h	0	0	0	0	0	0	0	0	INT19
S3 Resume									
E0h	1	1	0	1	0	0	0	0	S3 Resume PEIM (S3 started)
E1h	1	1	0	1	0	0	0	1	S3 Resume PEIM (S3 boot script)
E2h	1	1	0	1	0	0	1	0	S3 Resume PEIM (S3 Video Repost)
E3h	1	1	0	1	0	0	1	1	S3 Resume PEIM (S3 OS wake)
BIOS Recovery									
F0h	1	1	1	1	0	0	0	0	PEIM which detected forced Recovery condition
F1h	1	1	1	1	0	0	0	1	PEIM which detected User Recovery condition
F2h	1	1	1	1	0	0	1	0	Recovery PEIM (Recovery started)
F3h	1	1	1	1	0	0	1	1	Recovery PEIM (Capsule found)
F4h	1	1	1	1	0	1	0	0	Recovery PEIM (Capsule loaded)

Checkpoint	Diagnostic LED Decoder								Description
	1 = LED On, 0 = LED Off								
	Upper Nibble				Lower Nibble				
	MSB							LSB	
	8h	4h	2h	1h	8h	4h	2h	1h	
LED #	#7	#6	#5	#4	#3	#2	#1	#0	

### POST Memory Initialization MRC Diagnostic Codes

There are two types of POST Diagnostic Codes displayed by the MRC during memory initialization; Progress Codes and Fatal Error Codes.

The MRC Progress Codes are displays to the Diagnostic LEDs that show the execution point in the MRC operational path at each step.

**Table 52. MRC Progress Codes**

Checkpoint	Diagnostic LED Decoder								Description
	1 = LED On, 0 = LED Off								
	Upper Nibble				Lower Nibble				
	MSB							LSB	
	8h	4h	2h	1h	8h	4h	2h	1h	
LED	#7	#6	#5	#4	#3	#2	#1	#0	
<b>MRC Progress Codes</b>									
B0h	1	0	1	1	0	0	0	0	Detect DIMM population
B1h	1	0	1	1	0	0	0	1	Set DDR3 frequency
B2h	1	0	1	1	0	0	1	0	Gather remaining SPD data
B3h	1	0	1	1	0	0	1	1	Program registers on the memory controller level
B4h	1	0	1	1	0	1	0	0	Evaluate RAS modes and save rank information
B5h	1	0	1	1	0	1	0	1	Program registers on the channel level
B6h	1	0	1	1	0	1	1	0	Perform the JEDEC defined initialization sequence
B7h	1	0	1	1	0	1	1	1	Train DDR3 ranks
B8h	1	0	1	1	1	0	0	0	Initialize CLTT/OLTT
B9h	1	0	1	1	1	0	0	1	Hardware memory test and init
BAh	1	0	1	1	1	0	1	0	Execute software memory init
BBh	1	0	1	1	1	0	1	1	Program memory map and interleaving
BCh	1	0	1	1	1	1	0	0	Program RAS configuration
BFh	1	0	1	1	1	1	1	1	MRC is done

Memory Initialization at the beginning of POST includes multiple functions, including: discovery, channel training, validation that the DIMM population is acceptable and functional, initialization of the IMC and other hardware settings, and initialization of applicable RAS configurations.

When a major memory initialization error occurs and prevents the system from booting with data integrity, a beep code is generated, the MRC will display a fatal error code on the diagnostic LEDs, and a system halt command is executed. Fatal MRC error halts do NOT change the state of the System Status LED, and they do NOT get logged as SEL events. The following table lists all MRC fatal errors that are displayed to the Diagnostic LEDs.

Table 53. POST Progress LED Codes

Checkpoint	Diagnostic LED Decoder								Description
	1 = LED On, 0 = LED Off								
	Upper Nibble				Lower Nibble				
	MSB							LSB	
	8h	4h	2h	1h	8h	4h	2h	1h	
LED	#7	#6	#5	#4	#3	#2	#1	#0	
MRC Fatal Error Codes									
E8h	1	1	1	0	1	0	0	0	No usable memory error 01h = No memory was detected from the SPD read, or invalid config that causes no operable memory. 02h = Memory DIMMs on all channels of all sockets are disabled due to hardware memtest error. 3h = No memory installed. All channels are disabled.
E9h	1	1	1	0	1	0	0	1	Memory is locked by Intel Trusted Execution Technology and is inaccessible
EAh	1	1	1	0	1	0	1	0	DDR3 channel training error 01h = Error on read DQ/DQS (Data/Data Strobe) init 02h = Error on Receive Enable 3h = Error on Write Leveling 04h = Error on write DQ/DQS (Data/Data Strobe)
EBh	1	1	1	0	1	0	1	1	Memory test failure 01h = Software memtest failure. 02h = Hardware memtest failed. 03h = Hardware Memtest failure in Lockstep Channel mode requiring a channel to be disabled. <i>This is a fatal error which requires a reset and calling MRC with a different RAS mode to retry.</i>
EDh	1	1	1	0	1	1	0	1	DIMM configuration population error 01h = Different DIMM types (UDIMM, RDIMM, LRDIMM) are detected installed in the system. 02h = Violation of DIMM population rules. 03h = The 3rd DIMM slot cannot be populated when QR DIMMs are installed. 04h = UDIMMs are not supported in the 3rd DIMM slot. 05h = Unsupported DIMM Voltage.
EFh	1	1	1	0	1	1	1	1	Indicates a CLTT table structure error

## Appendix D: POST Code Errors

Most error conditions encountered during POST are reported using **POST Error Codes**. These codes represent specific failures, warnings, or are informational. POST Error Codes may be displayed in the Error Manager display screen, and are always logged to the System Event Log (SEL). Logged events are available to System Management applications, including Remote and Out of Band (OOB) management.

There are exception cases in early initialization where system resources are not adequately initialized for handling POST Error Code reporting. These cases are primarily Fatal Error conditions resulting from initialization of processors and memory, and they are handed by a Diagnostic LED display with a system halt.

The following table lists the supported POST Error Codes. Each error code is assigned an error type which determines the action the BIOS will take when the error is encountered. Error types include Minor, Major, and Fatal. The BIOS action for each is defined as follows:

- **Minor:** The error message is displayed on the screen or on the Error Manager screen, and an error is logged to the SEL. The system continues booting in a degraded state. The user may want to replace the erroneous unit. The POST Error Pause option setting in the BIOS setup does not have any effect on this error.
- **Major:** The error message is displayed on the Error Manager screen, and an error is logged to the SEL. The POST Error **P**ause option setting in the BIOS setup determines whether the system pauses to the Error Manager for this type of error so the user can take immediate corrective action or the system continues booting.

Note that for 0048 “Password check failed”, the system halts, and then after the next reset/reboot will displays the error code on the Error Manager screen.

- **Fatal:** The system halts during post at a blank screen with the text “**Unrecoverable fatal error found. System will not boot until the error is resolved**” and “**Press <F2> to enter setup**” The POST Error Pause option setting in the BIOS setup does not have any effect with this class of error.

When the operator presses the **F2** key on the keyboard, the error message is displayed on the Error Manager screen, and an error is logged to the SEL with the error code. The system cannot boot unless the error is resolved. The user needs to replace the faulty part and restart the system.

**Note:** The POST error codes in the following table are common to all current generation Intel server platforms. Features present on a given server board/system will determine which of the listed error codes are supported.

**Table 54. POST Error Codes and Messages**

Error Code	Error Message	Response
0012	System RTC date/time not set	Major
0048	Password check failed	Major
0140	PCI component encountered a PERR error	Major
0141	PCI resource conflict	Major
0146	PCI out of resources error	Major
0191	Processor core/thread count mismatch detected	Fatal
0192	Processor cache size mismatch detected	Fatal
0194	Processor family mismatch detected	Fatal
0195	Processor Intel(R) QPI link frequencies unable to synchronize	Fatal
0196	Processor model mismatch detected	Fatal
0197	Processor frequencies unable to synchronize	Fatal
5220	BIOS Settings reset to default settings	Major
5221	Passwords cleared by jumper	Major
5224	Password clear jumper is Set	Major
8130	Processor 01 disabled	Major
8131	Processor 02 disabled	Major
8132	Processor 03 disabled	Major
8133	Processor 04 disabled	Major
8160	Processor 01 unable to apply microcode update	Major
8161	Processor 02 unable to apply microcode update	Major
8162	Processor 03 unable to apply microcode update	Major
8163	Processor 04 unable to apply microcode update	Major
8170	Processor 01 failed Self Test (BIST)	Major
8171	Processor 02 failed Self Test (BIST)	Major
8172	Processor 03 failed Self Test (BIST)	Major
8173	Processor 04 failed Self Test (BIST)	Major
8180	Processor 01 microcode update not found	Minor
8181	Processor 02 microcode update not found	Minor
8182	Processor 03 microcode update not found	Minor
8183	Processor 04 microcode update not found	Minor
8190	Watchdog timer failed on last boot	Major
8198	OS boot watchdog timer failure	Major
8300	Baseboard management controller failed self-test	Major
8305	Hot Swap Controller failure	Major
83A0	Management Engine (ME) failed Self Test	Major
83A1	Management Engine (ME) Failed to respond.	Major
84F2	Baseboard management controller failed to respond	Major
84F3	Baseboard management controller in update mode	Major
84F4	Sensor data record empty	Major
84FF	System event log full	Minor
8500	Memory component could not be configured in the selected RAS mode	Major
8501	DIMM Population Error	Major
8520	DIMM_A1 failed test/initialization	Major
8521	DIMM_A2 failed test/initialization	Major
8522	DIMM_A3 failed test/initialization	Major
8523	DIMM_B1 failed test/initialization	Major
8524	DIMM_B2 failed test/initialization	Major
8525	DIMM_B3 failed test/initialization	Major
8526	DIMM_C1 failed test/initialization	Major
8527	DIMM_C2 failed test/initialization	Major
8528	DIMM_C3 failed test/initialization	Major
8529	DIMM_D1 failed test/initialization	Major
852A	DIMM_D2 failed test/initialization	Major
852B	DIMM_D3 failed test/initialization	Major
852C	DIMM_E1 failed test/initialization	Major

Error Code	Error Message	Response
852D	DIMM_E2 failed test/initialization	Major
852E	DIMM_E3 failed test/initialization	Major
852F	DIMM_F1 failed test/initialization	Major
8530	DIMM_F2 failed test/initialization	Major
8531	DIMM_F3 failed test/initialization	Major
8532	DIMM_G1 failed test/initialization	Major
8533	DIMM_G2 failed test/initialization	Major
8534	DIMM_G3 failed test/initialization	Major
8535	DIMM_H1 failed test/initialization	Major
8536	DIMM_H2 failed test/initialization	Major
8537	DIMM_H3 failed test/initialization	Major
8538	DIMM_I1 failed test/initialization	Major
8539	DIMM_I2 failed test/initialization	Major
853A	DIMM_I3 failed test/initialization	Major
853B	DIMM_J1 failed test/initialization	Major
853C	DIMM_J2 failed test/initialization	Major
853D	DIMM_J3 failed test/initialization	Major
853E	DIMM_K1 failed test/initialization	Major
853F (Go to 85C0)	DIMM_K2 failed test/initialization	Major
8540	DIMM_A1 disabled	Major
8541	DIMM_A2 disabled	Major
8542	DIMM_A3 disabled	Major
8543	DIMM_B1 disabled	Major
8544	DIMM_B2 disabled	Major
8545	DIMM_B3 disabled	Major
8546	DIMM_C1 disabled	Major
8547	DIMM_C2 disabled	Major
8548	DIMM_C3 disabled	Major
8549	DIMM_D1 disabled	Major
854A	DIMM_D2 disabled	Major
854B	DIMM_D3 disabled	Major
854C	DIMM_E1 disabled	Major
854D	DIMM_E2 disabled	Major
854E	DIMM_E3 disabled	Major
854F	DIMM_F1 disabled	Major
8550	DIMM_F2 disabled	Major
8551	DIMM_F3 disabled	Major
8552	DIMM_G1 disabled	Major
8553	DIMM_G2 disabled	Major
8554	DIMM_G3 disabled	Major
8555	DIMM_H1 disabled	Major
8556	DIMM_H2 disabled	Major
8557	DIMM_H3 disabled	Major
8558	DIMM_I1 disabled	Major
8559	DIMM_I2 disabled	Major
855A	DIMM_I3 disabled	Major
855B	DIMM_J1 disabled	Major
855C	DIMM_J2 disabled	Major
855D	DIMM_J3 disabled	Major
855E	DIMM_K1 disabled	Major
855F (Go to 85D0)	DIMM_K2 disabled	Major
8560	DIMM_A1 encountered a Serial Presence Detection (SPD) failure	Major
8561	DIMM_A2 encountered a Serial Presence Detection (SPD) failure	Major
8562	DIMM_A3 encountered a Serial Presence Detection (SPD) failure	Major

Error Code	Error Message	Response
8563	DIMM_B1 encountered a Serial Presence Detection (SPD) failure	Major
8564	DIMM_B2 encountered a Serial Presence Detection (SPD) failure	Major
8565	DIMM_B3 encountered a Serial Presence Detection (SPD) failure	Major
8566	DIMM_C1 encountered a Serial Presence Detection (SPD) failure	Major
8567	DIMM_C2 encountered a Serial Presence Detection (SPD) failure	Major
8568	DIMM_C3 encountered a Serial Presence Detection (SPD) failure	Major
8569	DIMM_D1 encountered a Serial Presence Detection (SPD) failure	Major
856A	DIMM_D2 encountered a Serial Presence Detection (SPD) failure	Major
856B	DIMM_D3 encountered a Serial Presence Detection (SPD) failure	Major
856C	DIMM_E1 encountered a Serial Presence Detection (SPD) failure	Major
856D	DIMM_E2 encountered a Serial Presence Detection (SPD) failure	Major
856E	DIMM_E3 encountered a Serial Presence Detection (SPD) failure	Major
856F	DIMM_F1 encountered a Serial Presence Detection (SPD) failure	Major
8570	DIMM_F2 encountered a Serial Presence Detection (SPD) failure	Major
8571	DIMM_F3 encountered a Serial Presence Detection (SPD) failure	Major
8572	DIMM_G1 encountered a Serial Presence Detection (SPD) failure	Major
8573	DIMM_G2 encountered a Serial Presence Detection (SPD) failure	Major
8574	DIMM_G3 encountered a Serial Presence Detection (SPD) failure	Major
8575	DIMM_H1 encountered a Serial Presence Detection (SPD) failure	Major
8576	DIMM_H2 encountered a Serial Presence Detection (SPD) failure	Major
8577	DIMM_H3 encountered a Serial Presence Detection (SPD) failure	Major
8578	DIMM_I1 encountered a Serial Presence Detection (SPD) failure	Major
8579	DIMM_I2 encountered a Serial Presence Detection (SPD) failure	Major
857A	DIMM_I3 encountered a Serial Presence Detection (SPD) failure	Major
857B	DIMM_J1 encountered a Serial Presence Detection (SPD) failure	Major
857C	DIMM_J2 encountered a Serial Presence Detection (SPD) failure	Major
857D	DIMM_J3 encountered a Serial Presence Detection (SPD) failure	Major
857E	DIMM_K1 encountered a Serial Presence Detection (SPD) failure	Major
857F (Go to 85E0)	DIMM_K2 encountered a Serial Presence Detection (SPD) failure	Major
85C0	DIMM_K3 failed test/initialization	Major
85C1	DIMM_L1 failed test/initialization	Major
85C2	DIMM_L2 failed test/initialization	Major
85C3	DIMM_L3 failed test/initialization	Major
85C4	DIMM_M1 failed test/initialization	Major
85C5	DIMM_M2 failed test/initialization	Major
85C6	DIMM_M3 failed test/initialization	Major
85C7	DIMM_N1 failed test/initialization	Major
85C8	DIMM_N2 failed test/initialization	Major
85C9	DIMM_N3 failed test/initialization	Major
85CA	DIMM_O1 failed test/initialization	Major
85CB	DIMM_O2 failed test/initialization	Major
85CC	DIMM_O3 failed test/initialization	Major
85CD	DIMM_P1 failed test/initialization	Major
85CE	DIMM_P2 failed test/initialization	Major
85CF	DIMM_P3 failed test/initialization	Major
85D0	DIMM_K3 disabled	Major
85D1	DIMM_L1 disabled	Major
85D2	DIMM_L2 disabled	Major
85D3	DIMM_L3 disabled	Major
85D4	DIMM_M1 disabled	Major
85D5	DIMM_M2 disabled	Major
85D6	DIMM_M3 disabled	Major
85D7	DIMM_N1 disabled	Major
85D8	DIMM_N2 disabled	Major
85D9	DIMM_N3 disabled	Major
85DA	DIMM_O1 disabled	Major

Error Code	Error Message	Response
85DB	DIMM_O2 disabled	Major
85DC	DIMM_O3 disabled	Major
85DD	DIMM_P1 disabled	Major
85DE	DIMM_P2 disabled	Major
85DF	DIMM_P3 disabled	Major
85E0	DIMM_K3 encountered a Serial Presence Detection (SPD) failure	Major
85E1	DIMM_L1 encountered a Serial Presence Detection (SPD) failure	Major
85E2	DIMM_L2 encountered a Serial Presence Detection (SPD) failure	Major
85E3	DIMM_L3 encountered a Serial Presence Detection (SPD) failure	Major
85E4	DIMM_M1 encountered a Serial Presence Detection (SPD) failure	Major
85E5	DIMM_M2 encountered a Serial Presence Detection (SPD) failure	Major
85E6	DIMM_M3 encountered a Serial Presence Detection (SPD) failure	Major
85E7	DIMM_N1 encountered a Serial Presence Detection (SPD) failure	Major
85E8	DIMM_N2 encountered a Serial Presence Detection (SPD) failure	Major
85E9	DIMM_N3 encountered a Serial Presence Detection (SPD) failure	Major
85EA	DIMM_O1 encountered a Serial Presence Detection (SPD) failure	Major
85EB	DIMM_O2 encountered a Serial Presence Detection (SPD) failure	Major
85EC	DIMM_O3 encountered a Serial Presence Detection (SPD) failure	Major
85ED	DIMM_P1 encountered a Serial Presence Detection (SPD) failure	Major
85EE	DIMM_P2 encountered a Serial Presence Detection (SPD) failure	Major
85EF	DIMM_P3 encountered a Serial Presence Detection (SPD) failure	Major
8604	POST Reclaim of non-critical NVRAM variables	Minor
8605	BIOS Settings are corrupted	Major
8606	NVRAM variable space was corrupted and has been reinitialized	Major
92A3	Serial port component was not detected	Major
92A9	Serial port component encountered a resource conflict error	Major
A000	TPM device not detected.	Minor
A001	TPM device missing or not responding.	Minor
A002	TPM device failure.	Minor
A003	TPM device failed self test.	Minor
A100	BIOS ACM Error	Major
A421	PCI component encountered a SERR error	Fatal
A5A0	PCI Express component encountered a PERR error	Minor
A5A1	PCI Express component encountered an SERR error	Fatal
A6A0	DXE Boot Service driver: Not enough memory available to shadow a Legacy Option ROM	Minor

## POST Error Beep Codes

The following table lists the POST error beep codes. Prior to system video initialization, the BIOS uses these beep codes to inform users on error conditions. The beep code is followed by a user-visible code on the POST Progress LEDs.

**Table 55. POST Error Beep Codes**

Beeps	Error Message	POST Progress Code	Description
1	USB device action	NA	Short beep sounded whenever a USB device is discovered in POST, or inserted or removed during runtime
1 long	Intel® TXT security violation	0xAE, 0xAF	System halted because Intel® Trusted Execution Technology detected a potential violation of system security.
3	Memory error	See Tables 28 and 29	System halted because a fatal error related to the memory was detected.
2	BIOS Recovery started	NA	Recovery boot has been initiated



Beeps	Error Message	POST Progress Code	Description
4	BIOS Recovery failure	NA	BIOS recovery has failed. This typically happens so quickly after recovery us initiated that it sounds like a 2-4 beep code.

The Integrated BMC may generate beep codes upon detection of failure conditions. Beep codes are sounded each time the problem is discovered, such as on each power-up attempt, but are not sounded continuously. Codes that are common across all Intel server boards and systems that use same generation chipset are listed in the following table. Each digit in the code is represented by a sequence of beeps whose count is equal to the digit.

**Table 56. Integrated BMC Beep Codes**

Code	Reason for Beep	Associated Sensors
1-5-2-1	No CPUs installed or first CPU socket is empty.	CPU1 socket is empty, or sockets are populated incorrectly CPU1 must be populated before CPU2.
1-5-2-4	MSID Mismatch	MSID mismatch occurs if a processor is installed into a system board that has incompatible power capabilities.
1-5-4-2	Power fault	DC power unexpectedly lost (power good dropout) – Power unit sensors report power unit failure offset
1-5-4-4	Power control fault (power good assertion timeout).	Power good assertion timeout – Power unit sensors report soft power control failure offset
1-5-1-2	VR Watchdog Timer sensor assertion	VR controller DC power on sequence was not completed in time.
1-5-1-4	Power Supply Status	The system does not power on or unexpectedly powers off and a Power Supply Unit (PSU) is present that is an incompatible model with one or more other PSUs in the system.

## Appendix E: Supported Intel® Server Chassis

The Intel® Server Board S2400SC requires a passive processor heat sink solution when integrated in the Intel® pedestal server chassis listed below. The Intel® Server Board S2400SC supports up to 95W TDP Intel® Xeon® Processor.

**Table 57. Intel® Server Chassis P4000S for S2400 family**

Intel® Server Chassis SKU	System Fans	Storage Drives	Power Supply(s)
P4304XXSHEN	Two Fixed Fans	Four 3.5" Hotswap Drive Bay	550W Fixed PSU
P4304XXSFDR	Two Fixed Fans	Four 3.5" Fixed Drive Trays	Two 460W CRPS
P4304XXSHEN	Two Fixed Fans	Four 3.5" Hotswap Drive Bay	550W Fixed PSU
P4304XXSFDR	Two Fixed Fans	Four 3.5" Fixed Drive Trays	Two 460W CRPS
P4304XXSFDN	Two Fixed Fans	Four 3.5" Fixed Drive Trays	One 460W CRPS
P4304XXSHDN	Two Fixed Fans	Four 3.5" Fixed Drive Trays	One 460W CRPS

**Table 58. Intel® Server Chassis P4000M family:**

Intel® Server Chassis SKU	System Fans	Storage Drives	Power Supply(s)
P4308XXMFEN	Two Fixed Fans	Eight 3.5" Fixed Drive Trays	550W Fixed PSU
P4308XXMHEN	Two Fixed Fans	Eight 3.5" Hotswap Drive Bay	550W Fixed PSU
P4308XXMFGN	Two Fixed Fans	Eight 3.5" Fixed Drive Trays	One 750W CRPS
P4308XXMHGC	Five Redundant Fans	Eight 3.5" Hotswap Drive Bay	One 750W CRPS
P4308XXMHGN	Two Fixed Fans	Eight 3.5" Hotswap Drive Bay	One 750W CRPS
P4308XXMHGR	Two Fixed Fans	Eight 3.5" Hotswap Drive Bay	Two 750W CRPS
P4308XXMFGR	Two Fixed Fans	Eight 3.5" Fixed Drive Bay	Two 750W CRPS
P4208XXMHDR	Two Fixed Fans	Eight 2.5" Hotswap Drive Bay	Two 460W CRPS
P4216XXMHGC	Five Redundant Fans	Sixteen 2.5" Hotswap Drive Bay	Two 750W CRPS
P4216XXMHGR	Two Fixed Fans	Sixteen 2.5" Hotswap Drive Bay	Two 750W CRPS
P4216XXMHEN	Two Fixed Fans	Sixteen 2.5" Hotswap Drive Bay	550W Fixed PSU

You must install the active processor heat sink with the airflow direction as shown in the following figure.

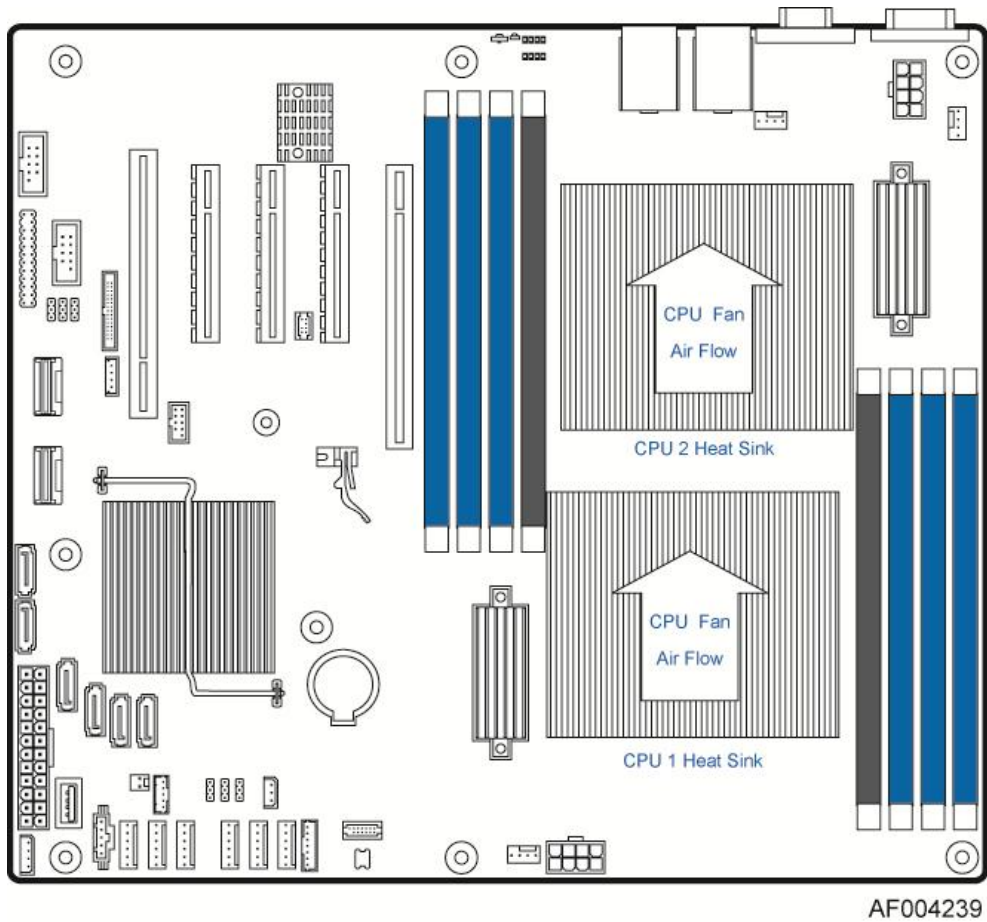

**Figure 30. Processor Heatsink Installation**

## Glossary

This appendix contains important terms used in the preceding chapters. For ease of use, numeric entries are listed first (for example, “82460GX”) with alpha entries following (for example, “AGP 4x”). Acronyms are then entered in their respective place, with non-acronyms following.

Term	Definition
ACPI	Advanced Configuration and Power Interface
AES	Advanced Encryption Standard
AMB	Advanced Memory Buffer (there is an AMB on each FBDIMM)
APIC	Advanced Programmable Interrupt Controller
ARP	Address Resolution Protocol
ASF	Alert Standards Forum
ASIC	Application specific integrated circuit
BIST	Built-in self test
BMC	Baseboard management controller
Bridge	Circuitry connecting one computer bus to another, allowing an agent on one to access the other.
BSP	Bootstrap processor
CBC	Chassis bridge controller. A microcontroller connected to one or more other CBCs. Together they bridge the IPMB buses of multiple chassis.
CLI	Command-line interface
CLTT	Closed-loop thermal throttling (memory throttling mode)
CMOS	In terms of this specification, this describes the PC-AT compatible region of battery-backed 128 bytes of memory on the server board.
CSR	Control and status register
D-cache	Data cache. Processor-local cache dedicated for memory locations explicitly loaded and stored by running code.
DHCP	Dynamic Host Configuration Protocol
DIB	Device Information Block
DPC	Direct Platform Control
EEPROM	Electrically erasable programmable read-only memory
EMP	Emergency management port
EPS	External Product Specification
FML	Fast management link
FNI	Fast management link network interface
FRB	Fault resilient booting
FRU	Field replaceable unit
FSB	Front side bus
FTM	Firmware transfer mode
GPIO	General-purpose input/output
HSBP	Hot-swap backplane
HSC	Hot-swap controller
I-cache	Instruction cache. Processor-local cache dedicated for memory locations retrieved through instruction fetch operations.

Term	Definition
I2C	Inter-integrated circuit bus
IA	Intel® architecture
IBF	Input buffer
ICH	I/O controller hub
IERR	Internal error
INIT	Initialization signal
IPMB	Intelligent Platform Management Bus
IPMI	Intelligent Platform Management Interface
ITP	In-target probe
KCS	Keyboard controller style
KT	Keyboard text
KVM	Keyboard, video, mouse
LAN	Local area network
LCD	Liquid crystal display
LPC	Low pin count
LUN	Logical unit number
MAC	Media Access Control
MD5	Message Digest 5. A hashing algorithm that provides higher security than MD2.
MIB	Modular information block. A descriptive text translation of a PET event, contained in a MIB file for use by an SNMP agent when decoding SEL entries.
ms	Millisecond
MUX	Multiplexer
NIC	Network interface card
NMI	Non-maskable interrupt
OBF	Output buffer
OEM	Original equipment manufacturer
OLTT	Open-loop thermal throttling (memory throttling mode)
PCI	Peripheral Component Interconnect
PECI	Platform Environmental Control Interface
PEF	Platform event filtering
PET	Platform event trap
PIA	Platform information area
PLD	Programmable logic device
POST	Power-on self-test
PROM	Programmable read-only memory
PSMI	Power Supply Management Interface
PWM	Pulse Width Modulation. The mechanism used to control the speed of system fans.
RAM	Random Access Memory
RAS	Reliability, availability, and serviceability
RC4	Rivest Cipher 4. A stream cipher designed by Rivest for RSA data security, now RSA security. It is a variable key-size stream cipher with byte-oriented operations. The algorithm is based on a random permutation.
RMCP+	Remote Management Control Protocol

Term	Definition
ROM	Read-only memory
RTC	Real-time clock
SCI	System Control Interrupt. A system interrupt used by hardware to notify the operating system of ACPI events.
SDR	Sensor data record
SDRAM	Synchronous dynamic random access memory
SEL	System event log
SHA1	Secure Hash Algorithm 1
SIO	Server Input/Output
SMBus*	A two-wire interface based on the I2C protocol. The SMBus* is a low-speed bus that provides positive addressing for devices and bus arbitration.
SMI	Server management interrupt. SMI is the highest priority non-maskable interrupt.
SMM	Server management mode
SMS	Server management software
SNMP	Simple Network Management Protocol
SOL	Serial-over-LAN
SPT	Straight pass-through
SRAM	Static random access memory
UART	Universal asynchronous receiver and transmitter
UDP	User Datagram Protocol
UHCI	Universal Host Controller Interface
VLAN	Virtual local area network

## Reference Documents

See the following documents for additional information:

- *Advanced Configuration and Power Interface Specification*, Revision 3.0, <http://www.acpi.info/>.
- *Intelligent Platform Management Bus Communications Protocol Specification*, Version 1.0. 1998. Intel Corporation, Hewlett-Packard\* Company, NEC\* Corporation, Dell\* Computer Corporation.
- *Intelligent Platform Management Interface Specification*, Version 2.0. 2004. Intel Corporation, Hewlett-Packard\* Company, NEC\* Corporation, Dell\* Computer Corporation.
- *Platform Support for Serial-over-LAN (SOL), TMode, and Terminal Mode External Architecture Specification*, Version 1.1, 02/01/02, Intel Corporation.
- *Intel® Remote Management Module User's Guide*, Intel Corporation.
- *Alert Standard Format (ASF) Specification, Version 2.0, 23 April 2003*, ©2000-2003, Distributed Management Task Force, Inc., <http://www.dmtf.org>.
- *BIOS for EPSD Platforms Based on Intel® Xeon Processor E5-4600/2600/2400/1600 Product Families External Product Specification*
- *EPSD Platforms Based On Intel Xeon® Processor E5 4600/2600/2400/1600 Product Families BMC Core Firmware External Product Specification*