

Intel[®] Modular Server System User Guide

A Guide for Technically Qualified Assemblers of Intel[®] Identified Subassemblies/Products

Intel Order Number D90833-019

Disclaimer

The source code contained or described herein and all documents related to the source code (Material) are owned by Intel Corporation or its suppliers or licensors. Title to the Material remains with Intel Corporation or its suppliers and licensors. The Material may contain trade secrets and proprietary and confidential information of Intel Corporation and its suppliers and licensors, and is protected by worldwide copyright and trade secret laws and treaty provisions. No part of the Material may be used, copied, reproduced, modified, published, uploaded, posted, transmitted, distributed, or disclosed in any way without Intel's prior express written permission. No license under any patent, copyright, trade secret or other intellectual property right is granted to or conferred upon you by disclosure or delivery of the Materials, either expressly, by implication, inducement, estoppel or otherwise. Any license under such intellectual property rights must be express and approved by Intel in writing.

Unless otherwise agreed by Intel in writing, you may not remove or alter this notice or any other notice embedded in Materials by Intel or Intel's suppliers or licensors in any way.

Information in this document is provided in connection with Intel products. No license, express or implied, by estoppel or otherwise, to any intellectual property rights is granted by this document. Except as provided in Intel's Terms and Conditions of Sale for such products, Intel assumes no liability whatsoever, and Intel disclaims any express or implied warranty, relating to sale and/or use of Intel products including liability or warranties relating to fitness for a particular purpose, merchantability, or infringement of any patent, copyright or other intellectual property right. Intel products are not designed, intended or authorized for use in any medical, life saving, or life sustaining applications or for any other application in which the failure of the Intel product could create a situation where personal injury or death may occur. Intel may make changes to specifications and product descriptions at any time, without notice.

Intel server boards contain a number of high-density VLSI and power delivery components that need adequate airflow for cooling. Intel's own chassis are designed and tested to meet the intended thermal requirements of these components when the fully integrated system is used together. It is the responsibility of the system integrator that chooses not to use Intel developed server building blocks to consult vendor datasheets and operating parameters to determine the amount of airflow required for their specific application and environmental conditions. Intel Corporation can not be held responsible if components fail or the server board does not operate correctly when used outside any of their published operating or non-operating limits.

Intel, Intel Core, and Xeon are trademarks or registered trademarks of Intel Corporation or its subsidiaries in the United States and other countries.

* Other names and brands may be claimed as the property of others.

Copyright © 2007- 2011, Intel Corporation. All Rights Reserved.

Preface

About this Manual

Thank you for purchasing and using the Intel® Modular Server System.

This manual is written for system technicians who are responsible for troubleshooting, upgrading, and repairing modular server systems. This document provides reference information, feature information, and step-by-step instructions for adding and replacing components in the Intel® Modular Server System. For the latest version of this manual, check the Intel® Modular Server System MFSYS25V2 product support web page.

Manual Organization

Chapter 1 provides a brief overview of the modular server system. This includes a list of the modular server system features, illustrations of the product, and product diagrams to help you identify components and their locations.

Chapter 2 provides instructions for adding and replacing components. It provides step-by-step instructions and diagrams for installing or replacing components such as the fans, power supplies, hard drives, compute modules, and other components.

Chapter 3 provides instructions and information on using the modular server system. This includes information for powering on and powering off the modular server system and installing an operating system.

Chapter 4 provides information and instructions on how to use the Intel® Modular Server Control user interface to configure the modular server system. This includes step-by-step instructions and screenshots for configuring the system components, updating the modular server system firmware, and monitoring system health.

Chapter 5 provides information to assist you in troubleshooting the Intel® Modular Server System. This includes information on hardware diagnostics as well as a list of possible solutions for problems like no video display, no available storage, network problems, and several other possible issues.

The back of this manual provides technical specifications, regulatory information, 'getting help' information, and the warranty.

Safety Information

Important Safety Instructions

Read all caution and safety statements in this document before performing any of the instructions. See also *Intel® Server Boards and Server Chassis Safety Information* at: <http://www.intel.com/support/motherboards/server/sb/cs-010770.htm>

Wichtige Sicherheitshinweise

Lesen Sie zunächst sämtliche Warn- und Sicherheitshinweise in diesem Dokument, bevor Sie eine der Anweisungen ausführen. Beachten Sie hierzu auch die *Intel® Server Boards and Server Chassis Safety Information* unter: <http://www.intel.com/support/motherboards/server/sb/cs-010770.htm>

Consignes de sécurité

Lisez attention toutes les consignes de sécurité et les mises en garde indiquées dans ce document avant de suivre toute instruction. Consultez *Intel® Server Boards and Server Chassis Safety Information* sur le site: <http://www.intel.com/support/motherboards/server/sb/cs-010770.htm>

Instrucciones de seguridad importantes

Lea todas las declaraciones de seguridad y precaución de este documento antes de realizar cualquiera de las instrucciones. Vea *Intel® Server Boards and Server Chassis Safety Information* en: <http://www.intel.com/support/motherboards/server/sb/cs-010770.htm>

重要安全指导

在执行任何指令之前，请阅读本文档中的所有注意事项及安全声明。和/或 <http://support.intel.com/support/motherboards/server/sb/CS-010770.htm> 上的 *Intel Server Boards and Server Chassis Safety Information* (《Intel 服务器主板与服务器机箱安全信息》)。

Warnings

These warnings and cautions apply whenever you remove the compute module enclosure cover to access components inside the system. Only a technically qualified person should maintain or configure the system.

Heed safety instructions: Before working with your server product, whether you are using this guide or any other resource as a reference, pay close attention to the safety instructions. You must adhere to the assembly instructions in this guide to ensure and maintain compliance with existing product certifications and approvals. Use only the described, regulated components specified in this guide. Use of other products/components will void the UL listing and other regulatory approvals of the product and will most likely result in noncompliance with product regulations in the region(s) in which the product is sold.

System power on/off: The power button DOES NOT turn off the system AC power. To remove power from the system, you must unplug the AC power cord from the wall outlet or the chassis. Make sure the AC power cord is unplugged before you open the chassis, add, or remove any components.

Hazardous conditions, devices and cables: Hazardous electrical conditions may be present on power, telephone, and communication cables. Turn off the system and disconnect the power cord, telecommunications systems, networks, and modems attached to the system before opening it. Otherwise, personal injury or equipment damage can result.

Electrostatic discharge (ESD) and ESD protection: ESD can damage disk drives, boards, and other parts. We recommend that you perform all procedures in this document only at an ESD workstation. If one is not available, provide some ESD protection by wearing an anti-static wrist strap attached to chassis ground (any unpainted metal surface) on your system when handling parts.

ESD and handling electronic devices: Always handle electronic devices carefully. They can be extremely sensitive to ESD. Do not touch the connector contacts.

Installing or removing jumpers: A jumper is a small plastic encased conductor that slips over two jumper pins. Some jumpers have a small tab on top that you can grip with your fingertips or with a pair of fine needle nosed pliers. If your jumpers do not have such a tab, take care when using needle nosed pliers to remove or install a jumper; grip the narrow sides of the jumper with the pliers, never the wide sides. Gripping the wide sides can damage the contacts inside the jumper, causing intermittent problems with the function controlled by that jumper. Take care to grip with, but not squeeze, the pliers or other tool you use to remove a jumper, or you may bend or break the pins on the board.

Reinstalling enclosure cover: To protect internal components and for proper cooling and airflow, the compute module should not be inserted into the chassis with the cover removed; operating it without the enclosure cover in place can damage system parts.

Table of Contents

| | |
|---|------------|
| Preface | iii |
| About this Manual | iii |
| Manual Organization | iii |
| Safety Information | v |
| Important Safety Instructions | v |
| Wichtige Sicherheitshinweise | v |
| Consignes de sécurité | v |
| Instrucciones de seguridad importantes | v |
| Warnings..... | vi |
| Modular Server System Features | 1 |
| Modular Server System Feature Overview | 1 |
| Intel® Modular Server Systems Content and References | 2 |
| Additional Information and Software | 4 |
| Major Components | 5 |
| Front View | 5 |
| Rear View | 7 |
| Front Chassis Connectors and Indicators..... | 9 |
| Compute Module Connectors and Indicators | 9 |
| Back Chassis Connectors and Indicators | 10 |
| Rack Mount Options | 11 |
| Hardware Installations and Upgrades | 13 |
| Before You Begin | 13 |
| Tools and Supplies Needed | 13 |
| Chassis References | 13 |
| Installing the Intel® Modular Server System MFSYS25V2 in a Rack | 13 |
| Installation Guidelines | 13 |
| Installing Temporary Handles on System | 14 |
| Mounting System in Rack | 15 |
| Hot-Swap Module Installation and Removal Guidelines | 15 |
| Replacing the Management Module | 16 |
| Removing the Management Module | 16 |
| Installing the Management Module | 17 |
| Installing and Removing an Ethernet Switch Module | 19 |
| Installing an Ethernet Switch Module | 19 |
| Removing an Ethernet Switch Module | 20 |
| Installing and Removing a Storage Control Module | 22 |
| Installing a Storage Control Module | 22 |
| Removing a Storage Control Module | 23 |

| | |
|---|-----------|
| Installing and Removing the Backup Battery..... | 25 |
| Installing a Backup Battery | 25 |
| Removing a Backup Battery | 26 |
| Installing and Removing a Power Supply Module | 28 |
| Installing a Power Supply Module | 29 |
| Removing a Power Supply Module | 30 |
| Replacing a Main Cooling Module | 31 |
| Removing a Main Cooling Module | 32 |
| Installing a Main Cooling Module | 33 |
| Replacing the I/O Cooling Module | 33 |
| Removing the I/O Cooling Module | 34 |
| Installing the I/O Cooling Module | 35 |
| Installing and Removing Hard Drives | 35 |
| Installing a 2.5-inch Hard Drive into the Storage Bay | 36 |
| Removing a 2.5-inch Hard Drive from the Storage Bay | 39 |
| Installing and Removing an Intel® Compute Module | 43 |
| Installing an Intel® Compute Module | 43 |
| Removing an Intel® Compute Module | 44 |
| Using the Modular Server System | 45 |
| Minimum Hardware Requirements | 45 |
| Starting Up Server System | 45 |
| Installing an Operating System | 45 |
| Monitoring the Server System | 46 |
| Shutting Down the Server System | 46 |
| Using the Intel® Modular Server Control User Interface | 47 |
| Introduction | 47 |
| System Configuration Requirements | 48 |
| Setting Up a Remote Connection | 49 |
| Remote Client System Requirements | 50 |
| Log in to the Intel® Modular Server Control | 50 |
| Layout and Key Navigation Features | 52 |
| Chassis Front | 56 |
| System | 57 |
| Intel® Compute Module View | 57 |
| Storage Configuration | 63 |
| Intel® Gigabit Ethernet Switch Module 1 and 2 | 84 |
| Virtual Machines | 92 |
| Chassis Back | 112 |
| Intel® Storage Control Module 1 and 2 | 113 |
| Intel® Management Module | 117 |
| Intel® Modular Server Fans and Power Supplies | 120 |
| Reports | 121 |
| Storage Layout | 122 |

| | |
|---|------------|
| Events | 124 |
| Dashboard | 126 |
| Diagnostics | 127 |
| Settings | 131 |
| Storage Options | 132 |
| IP Configuration | 133 |
| Date and Time | 135 |
| Simple Network Management Protocol (SNMP) | 137 |
| User Accounts | 142 |
| LDAP | 142 |
| Event Policies | 143 |
| Notification | 145 |
| Configure Networking | 148 |
| Cluster Share Screen | 152 |
| Sys Import/Export | 154 |
| Language Option Setting | 155 |
| Feature Activation | 156 |
| Firmware Updates | 158 |
| Restore System Settings | 159 |
| Access Online Help | 161 |
| Log Out from the Intel® Modular Server Control | 162 |
| Troubleshooting | 163 |
| First Steps Checklist | 163 |
| Specific Issues and Corrective Actions | 163 |
| Chassis Fan Module Not Functioning | 164 |
| Cannot Connect to the Management Module | 164 |
| Cannot Connect to a Compute Module | 164 |
| Cannot Connect a Compute Module to a Storage Control Module | 165 |
| Diagnostic LED Information | 165 |
| A Product Regulatory Requirements | 169 |
| Regulatory and Certification Information | 169 |
| Product Regulatory Compliance | 169 |
| Product Regulatory Compliance Markings | 171 |
| Regulated Specified Components | 177 |
| Electromagnetic Compatibility Notices | 178 |
| FCC Verification Statement (USA) | 178 |
| B Installation/Assembly Safety Instructions | 183 |
| English | 183 |
| Deutsch | 185 |
| Français | 188 |
| Español | 190 |
| Italiano | 192 |
| C Safety Information | 195 |

| | |
|---|-----|
| English | 195 |
| Server Safety Information | 195 |
| Safety Warnings and Cautions | 195 |
| Intended Application Uses | 196 |
| Site Selection | 196 |
| Equipment Handling Practices | 196 |
| Power and Electrical Warnings | 197 |
| Access Warnings | 197 |
| Electrostatic Discharge (ESD) | 198 |
| Other Hazards | 198 |
| Deutsch | 199 |
| Sicherheitshinweise für den Server | 199 |
| Sicherheitshinweise und Vorsichtsmaßnahmen | 199 |
| Zielbenutzer der Anwendung | 200 |
| Standortauswahl | 200 |
| Handhabung von Geräten | 201 |
| Warnungen zu Netzspannung und Elektrizität | 202 |
| Warnhinweise für den Systemzugang | 202 |
| Elektrostatische Entladungen (ESD) | 203 |
| Andere Gefahren | 204 |
| Français | 205 |
| Consignes de sécurité sur le serveur | 205 |
| Sécurité: avertissements et mises en garde | 205 |
| Domaines d'utilisation prévus | 206 |
| Sélection d'un emplacement | 206 |
| Pratiques de manipulation de l'équipement | 206 |
| Alimentation et avertissements en matière d'électricité | 207 |
| Avertissements sur l'accès au système | 207 |
| Décharges électrostatiques (ESD) | 208 |
| Autres risques | 208 |
| Español | 209 |
| Información de seguridad del servidor | 209 |
| Advertencias y precauciones sobre seguridad | 209 |
| Aplicaciones y usos previstos | 210 |
| Selección de la ubicación | 210 |
| Manipulación del equipo | 211 |
| Advertencias de alimentación y eléctricas | 211 |
| Advertencias el acceso al sistema | 211 |
| Descarga electrostática (ESD) | 212 |
| Otros peligros | 213 |

List of Figures

| | |
|---|----|
| Figure 1. Intel® Modular Server System MFSYS25V2 | 1 |
| Figure 2. Front View of Intel® Modular Server System MFSYS25V2 | 5 |
| Figure 3. Rear View of Server System | 7 |
| Figure 4. Intel® Modular Server System MFSYS25V2 Front Chassis Connectors and Indicators 9 | |
| Figure 5. Rear Chassis Connectors and Indicators..... | 10 |
| Figure 6. Installing Temporary Handles | 14 |
| Figure 7. Removing the Management Module | 17 |
| Figure 8. Installing the Management Module | 18 |
| Figure 9. Installing an Ethernet Switch Module | 20 |
| Figure 10. Removing an Ethernet Switch Module | 21 |
| Figure 11. Installing a Storage Control Module | 23 |
| Figure 12. Removing a Storage Control Module | 24 |
| Figure 13. Removing Top Cover from Storage Control Module | 25 |
| Figure 14. Installing Backup Battery..... | 26 |
| Figure 15. Removing Top Cover from Storage Control Module | 27 |
| Figure 16. Removing Backup Battery..... | 28 |
| Figure 17. Removing Filler Module | 29 |
| Figure 18. Installing Power Supply Module | 30 |
| Figure 19. Removing a Power Supply Module | 31 |
| Figure 20. Removing a Main Cooling Module | 32 |
| Figure 21. Installing a Main Cooling Module | 33 |
| Figure 22. Removing an I/O Cooling Module | 34 |
| Figure 23. Installing an I/O Cooling Module | 35 |
| Figure 24. Removing a 2.5-inch Drive Carrier from a Drive Bay Module | 36 |
| Figure 25. Installing Hard Drive into Drive Carrier..... | 37 |
| Figure 26. Attaching AXXTM3SATA to the Drive | 38 |
| Figure 27. Installing 2.5-inch Drive Carrier in Drive Bay Module..... | 39 |
| Figure 28. Removing a 2.5-inch Drive Carrier from the Drive Bay Module | 40 |
| Figure 29. Removing Hard Drive from a Drive Carrier | 41 |
| Figure 30. Removing AXXTM3SATA from the Drive..... | 42 |
| Figure 31. Installing an Intel® Compute Module | 43 |
| Figure 32. Removing an Intel® Compute Module | 44 |
| Figure 33. Connection using a switch | 49 |
| Figure 34. Connection using a cross-over cable | 49 |
| Figure 35. Intel® Modular Server Control Login | 51 |
| Figure 36. Intel® Modular Server Control General Layout..... | 52 |
| Figure 37. Intel® Modular Server Control Configuration Screen Layout..... | 53 |
| Figure 38. Chassis Front View | 56 |
| Figure 39. Intel® Compute Module View | 58 |
| Figure 40. Server Action - Remote KVM & CD | 62 |
| Figure 41. Initial Storage Configuration Screen | 64 |

| | |
|---|-----|
| Figure 42. Create Storage Pool Dialog Box..... | 64 |
| Figure 43. Create Storage Pool Dialog Box Example..... | 66 |
| Figure 44. Storage Pool Screen..... | 67 |
| Figure 45. Create Virtual Drive Dialog Box..... | 71 |
| Figure 46. Virtual Drive Screen..... | 73 |
| Figure 47. Assign Virtual Drive..... | 77 |
| Figure 48. Deleted Virtual Drive..... | 78 |
| Figure 49. Physical Drives..... | 79 |
| Figure 50. External Ports..... | 84 |
| Figure 51. Intel® Gigabit Ethernet Switch Module View..... | 85 |
| Figure 52. Configure Ports Dialog Box..... | 89 |
| Figure 53. Reset Switch Screen..... | 90 |
| Figure 54. Advanced Configuration Screen..... | 91 |
| Figure 55. Servers Screen..... | 93 |
| Figure 56. Create a VM Storage Pool screen..... | 94 |
| Figure 57. Virtualization Progress Bar..... | 94 |
| Figure 58. VM Pool result popup..... | 95 |
| Figure 59. VM Pool Screen..... | 95 |
| Figure 60. Virtual Machines Screen..... | 98 |
| Figure 61. Create VM Screen: Basic Tab..... | 102 |
| Figure 62. Create VM Screen: Install tab..... | 103 |
| Figure 63. Create VM Screen: Advanced Tab..... | 104 |
| Figure 64. Create VM Screen: Network Tab..... | 105 |
| Figure 65. Network Tab: Two NICs..... | 106 |
| Figure 66. Create VM Screen: Storage Tab..... | 107 |
| Figure 67. Create VM Screen: Finish Tab..... | 108 |
| Figure 68. ISO Store Screen..... | 109 |
| Figure 69. Remote KVM Pop Up Terminal Window..... | 112 |
| Figure 70. Chassis Back View..... | 113 |
| Figure 71. Intel® Storage Control Module View..... | 114 |
| Figure 72. Intel® Management Module View..... | 118 |
| Figure 73. Storage Layout Graphical View..... | 123 |
| Figure 74. Storage Layout Tabular View..... | 124 |
| Figure 75. System Event Log Screen..... | 125 |
| Figure 76. Event Policy Record Window..... | 126 |
| Figure 77. Dashboard View..... | 127 |
| Figure 78. Diagnostics..... | 128 |
| Figure 79. Diagnostic Tests..... | 129 |
| Figure 80. System Information Report Download..... | 129 |
| Figure 81. System Information Report..... | 130 |
| Figure 82. Diagnostics - Service Data..... | 131 |
| Figure 83. Settings - Storage Options Configuration..... | 133 |
| Figure 84. Settings - IP Configuration..... | 134 |
| Figure 85. Settings - System Date and Time Configuration..... | 135 |
| Figure 86. Calendar..... | 136 |
| Figure 87. SNMP Options..... | 138 |
| Figure 88. SNMP V3..... | 140 |

| | |
|--|-----|
| Figure 89. Reset SNMP v3..... | 141 |
| Figure 90. Settings - User Account Configuration Screen..... | 142 |
| Figure 91. LDAP Authentication Configuration..... | 143 |
| Figure 92. Settings - Event Policies Configuration Screen..... | 144 |
| Figure 93. Email Notification Configuration | 146 |
| Figure 94. SYSLOG Notification Setting | 147 |
| Figure 95. Networking Screen..... | 148 |
| Figure 96. Vlan port listing - Switch screen | 149 |
| Figure 97. Networking: Additional Vlans Added | 151 |
| Figure 98. Cluster Share Configuration Screen | 152 |
| Figure 99. Windows 7: Computer Screen | 153 |
| Figure 100. Window 7: Map Network Drive Pop Up..... | 153 |
| Figure 101. Windows 7: Mapped Drive Login Pop Up | 154 |
| Figure 102. Mapped Remote Folder | 154 |
| Figure 103. Sys Import /Export..... | 155 |
| Figure 104. Settings - Help Language Selection..... | 156 |
| Figure 105. Settings - Feature Activation | 157 |
| Figure 106. Settings - Firmware Update Screen | 158 |
| Figure 107. Settings - Restore System Settings | 160 |
| Figure 108. Online Help | 162 |

List of Tables

| | |
|---|-----|
| Table 1. Modular Server System Features..... | 2 |
| Table 2. Intel® Modular Server System MFSYS25V2 Contents..... | 2 |
| Table 3. Modular Server System References | 4 |
| Table 4. Hardware Requirements | 45 |
| Table 5. Minimum System Requirements for Remote Web Console | 50 |
| Table 6. Intel® Modular Server Control Configuration Screen Layout..... | 54 |
| Table 7. Health Icons | 59 |
| Table 8. Server Action Menu..... | 59 |
| Table 9. Server Tabs..... | 61 |
| Table 10. Health Icons | 67 |
| Table 11. Storage Pool Actions Menu..... | 68 |
| Table 12. Storage Pool Tabs..... | 70 |
| Table 13. Health Icons | 74 |
| Table 14. Virtual Drive Action Menu..... | 75 |
| Table 15. Virtual Drive Tabs..... | 76 |
| Table 16. Health Icons | 80 |
| Table 17. Physical Drive Action Menu..... | 81 |
| Table 18. Physical Drive Tabs..... | 82 |
| Table 19. Health Icons | 86 |
| Table 20. Switch Module Action Menu | 86 |
| Table 21. Switch Module Tabs | 87 |
| Table 22. Health Icons | 96 |
| Table 23. VM Pool Action Menu..... | 96 |
| Table 24. VM Pool Tabs..... | 97 |
| Table 25. Health Icons | 99 |
| Table 26. Virtual Machine Action Menu..... | 100 |
| Table 27. Virtual Machine Tabs..... | 101 |
| Table 28. Health Icons | 115 |
| Table 29. Status Messages..... | 115 |
| Table 30. Storage Control Module Action Menu | 116 |
| Table 31. Storage Control Module Tabs | 117 |
| Table 32. Health Icons | 119 |
| Table 33. Management Module Action Menu..... | 119 |
| Table 34. Management Module Tabs..... | 120 |
| Table 35. Health Icons | 121 |
| Table 36. Fans and Power Supplies Tabs | 121 |
| Table 37. Diagnostic LEDs..... | 166 |
| Table 38. NIC LEDs | 167 |

1 Modular Server System Features

The following version of the Intel® Modular Server System is featured:

- Intel® Modular Server System MFSYS25V2

This chapter briefly describes the main features of the Intel® Modular Server System MFSYS25V2. This chapter provides photographs and illustrations of the product, a features list, and diagrams showing the location of important components and connections on the server chassis.

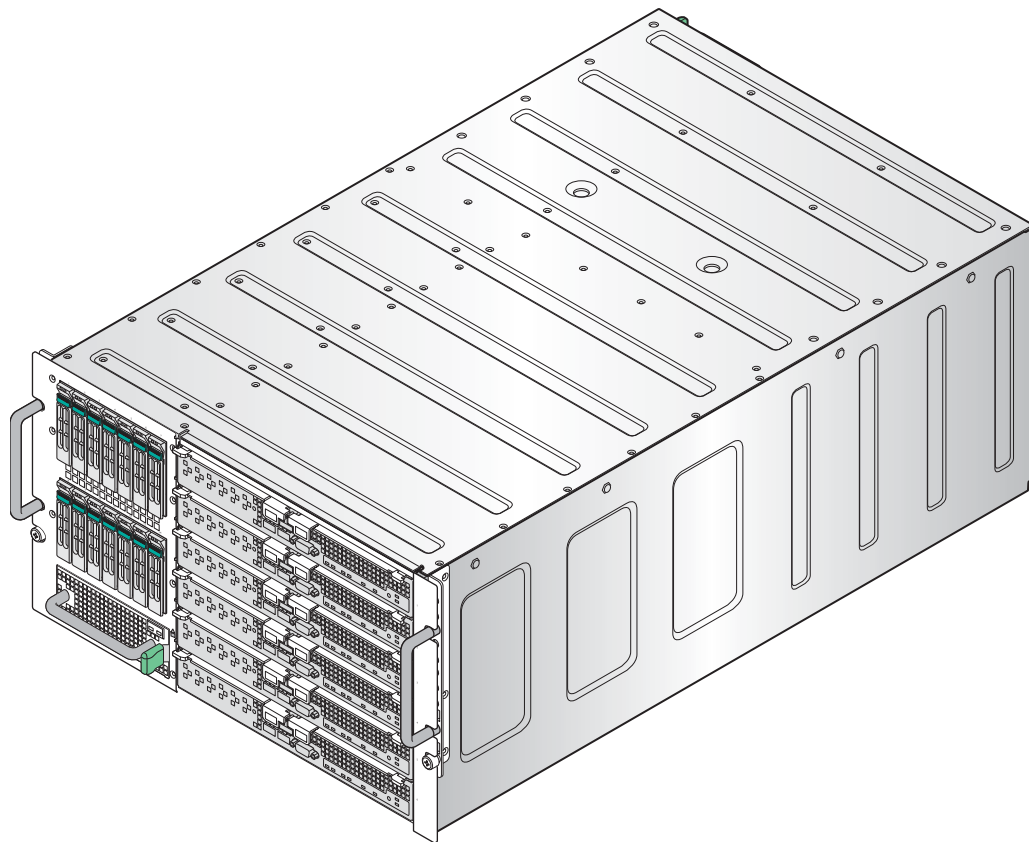

AF002423

Figure 1. Intel® Modular Server System MFSYS25V2

Modular Server System Feature Overview

Table 1 provides an overview of the modular server system configuration.

Table 1. Modular Server System Features

| Feature | Description |
|-------------------------------|---|
| Chassis Dimensions | <ul style="list-style-type: none"> • 10.3 inches (261.4 mm) high – 6U • 17.5 inches (444.4 mm) wide • 28.4 inches (720.2) mm long • 187 lbs (85 kg) - maximum full configuration weight |
| Module Bays (rear) | <ul style="list-style-type: none"> • Four hot-plug 110/220V power module bays • Two hot-swap Ethernet switch module bays • Two hot-swap storage control module bays • Two hot-swap main cooling module bays • One hot-swap management module bay |
| Module Bays (front) | <ul style="list-style-type: none"> • Six hot-plug compute module bays • One hot-swap I/O cooling module bay • One hard disk drive bay |
| Hard Disk Drive Bay | <ul style="list-style-type: none"> • Intel® Modular Server System MFSYS25V2: 14 hot-swap 2.5-inch SAS hard disk drive carriers with filler blanks installed (hard disk drives are NOT included) |
| Intel® Modular Server Control | <ul style="list-style-type: none"> • Powerful integrated management GUI for configuration and chassis management • Provides a single interface for system updates |

Intel® Modular Server Systems Content and References

The following version of the Intel® Modular Server System is available:

- Intel® Modular Server System MFSYS25V2

Intel® Modular Server System MFSYS25V2 Contents

Your Intel® Modular Server System MFSYS25V2 ships with the following items:

Table 2. Intel® Modular Server System MFSYS25V2 Contents

| Quantity | Description |
|-----------------|---------------------------------------|
| One | Chassis enclosure |
| One | Intel® Management Module 2 |
| One | Intel® Gigabit Ethernet Switch Module |
| One | Intel® Storage Control Module |
| 14 | 2.5" hard disk drive carriers |
| Two | 1000W Power Supply Modules |
| Two | Main Cooling Fan Modules |
| One | I/O Cooling Fan Module |

Table 2. Intel® Modular Server System MFSYS25V2 Contents

| Quantity | Description |
|----------|---|
| Two | Blank Power Supply Fan Blanks |
| Five | Server Blanks (Compute Module filler panels) |
| Two | Blank filler panels for rear module bays SCM2 and SWM2 |
| One | Documentation package including: System Quick Start Guide, Safety Flyer and Resource CD |

Note: *The MFSYS25V2 base configuration does not include hard drives, compute modules or power cords.*

Additional Information and Software

If you need more information about this products or information about the accessories that can be used with this modular server system, use the following resources.

Table 3. Modular Server System References

| For this information or software | Use this Document or Software |
|--|--|
| For in-depth technical information about the modular server system, including subsystem overviews and mechanical drawings | <p><i>Intel® Modular Server System Technical Product Specification</i></p> <p>Available at: http://www.intel.com/support/motherboards/server/mfsys25/sb/CS-028599.htm</p> |
| For in-depth technical information about the server board, including board layout, connector pin-outs, timing information, mechanical drawings and LED information | <p><i>Intel® Compute Module MFS5520VI Technical Product Specification</i></p> <p>Available at: http://www.intel.com/p/en_US/support/highlights/server/mfs5520vi</p> <p><i>Intel® Compute Module MFS5520VI User Guide</i></p> <p>Available at: http://www.intel.com/p/en_US/support/highlights/server/mfs5520vi</p> |
| If you just received this product and you need to assemble your modular server system and install components | <p><i>Intel® Modular Server System MFSYS25V2 Quick Start User's Guide</i></p> <p>Provided in the product box or available for download at: http://www.intel.com/support/motherboards/server/mfsys25/sb/CS-028599.htm</p> |
| Accessories or other Intel server products | <p>Spares, Parts List, and Configuration Guide</p> <p>Available at: http://www.intel.com/support/motherboards/server/sb/CS-028600.htm</p> |
| Latest drivers, Unified Firmware Update packages, and utilities | <p>Available for download at: http://downloadcenter.intel.com/SearchResult.aspx?lang-eng&ProductFamily=Server+Products&ProductLine=Intel%c2%ae+Modular+Server+Systems&ProductProduct=Intel%c2%ae+Modular+Server+System+MFSYS25V2</p> <p>Click the Software and Drivers link on the left side of the web page.</p> |
| For software to manage your Intel® server | <p>Intel® Modular Server Control UI: The Intel® Management Module integrated management interface for the modular server system. For instructions and information, refer to the <i>Intel® Modular Server System MFSYS25V2 User Guide</i>.</p> <p>Available at: http://www.intel.com/support/motherboards/server/mfsys25/sb/CS-028608.htm</p> |

Major Components

Front View

Figure 2 shows the front view of the platform. The front provides access to the following components.

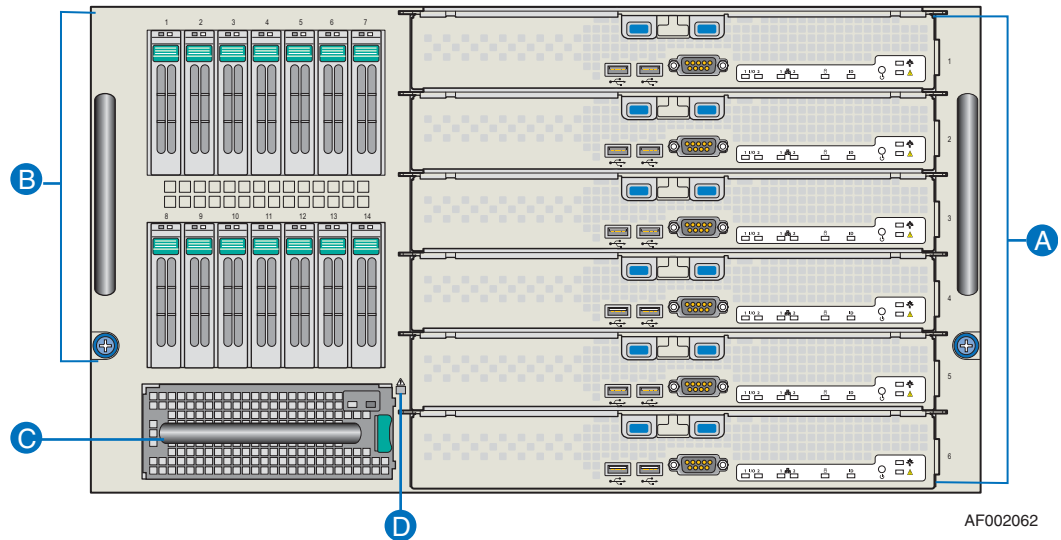

AF002062

| Item | Description |
|------|---|
| A | Compute modules or filler panels (six) [Compute Module 1 on top and Compute Module 6 on bottom] |
| B | Hard Disk Drive bay module with hot-swap 2.5-inch SAS hard disk drives (14) [HDD 1 on the upper left and HDD 14 on the lower right] |
| C | I/O cooling module |
| D | System Status LED |

Figure 2. Front View of Intel® Modular Server System MFSYS25V2

Compute Module

The Intel® Modular Server System MFSYS25V2 supports up to six compute modules. Each compute module is a general-purpose server built around the following minimum features:

- Processor(s)
- Memory
- Integrated Baseboard Management Controller
- Network interface
- Storage control module

For more information, refer to the appropriate compute module *Technical Product Specification* and *User Guide*.

Hard Disk Drive Bay Module

The Intel® Modular Server System MFSYS25V2 has an integrated hard disk drive bay module with the following features:

- Intel® Modular Server System MFSYS25V2 has an integrated hot-swap 2.5-inch SAS hard disk drive bay module that can support up to a maximum of 14 hard disk drives.
- Storage configuration and management are supported via the Intel® Modular Server Control UI.

To access the installed physical drives, you must install at least one Intel® Storage Control Module in the rear bay labeled SCM1.

Because hard disk drives have different cooling, power, and vibration characteristics, Intel validates specific hard disk drive types in the platforms. See the Intel® Modular Server System MFSYS25V2 *Tested Hardware and Operating System List* for a list of qualified drives.

I/O Cooling Module

The I/O cooling module consists of six fans in a hot-swap module with power and status indicators. These fans provide cooling for all I/O modules. The I/O cooling module is accessible from the front of the system even though it cools the I/O modules in the rear of the system.

Rear View

Figure 3 shows a rear view of the platform. The rear provides access to the following components:

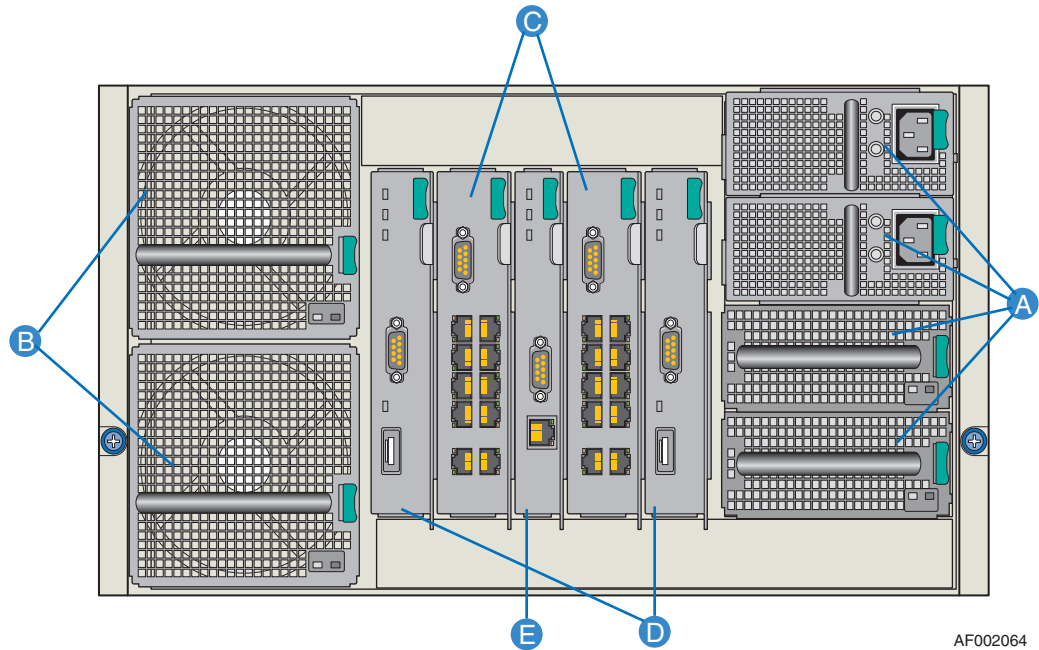

AF002064

| Item | Description |
|-------------------------|--|
| A | Power supply module bays (four) (as illustrated: two top bays occupied by power supply modules; two bottom bays occupied by power supply blanks) |
| B | Main cooling module bays (two) |
| I/O Module Slots | |
| C | Ethernet switch module slots (two) |
| D | Storage control module slots (two) |
| E | Management module slot (one) |

Figure 3. Rear View of Server System

Power Supply Module

Up to four hot-swap power supply modules can be installed in the right rear of the chassis. Each supply has its own AC input power connector and is rated at 1000 watts over an input range of 100-240 VAC. Each power supply includes two fans that provide cooling for hot-swap disk drives. All four power supply bays must be populated with either a power supply module or a power supply blank. The power supply blank has two fans that ensure proper system cooling.

One power supply supports one compute module plus all other modules in the system.

Two power supplies support two to three compute modules (in any slot) plus all other modules in the system.

Three power supplies support four to six compute modules (in any slot) plus all other modules in the system.

Any additional power supplies above the minimum required (based on configuration) provide redundancy.

I/O Module Slots

The middle-rear of the chassis can accommodate up to four expansion modules.

Ethernet Switch Module

One or two hot-swap Intel® Gigabit Ethernet Switch Modules can be installed. Each switch has ten uplink ports and twelve internal server bay ports, two ports routed to each compute module. One switch module is the minimum configuration; a second switch module allows for network redundancy.

Storage Control Module

One or two hot-swap Intel® Storage Control Modules can be used for up to 14 hot-swap SAS hard drives in the Intel® Modular Server System MFSYS25V2. One storage control module is the minimum configuration; a second storage control module allows for storage control module redundancy. When two storage control modules are installed and one fails, drive access is maintained through the operational storage control module.

Management Module

The Intel® Management Module 2 is installed in the middle-rear of the chassis, between the four I/O slots. This module provides an Internet browser interface that enables the configuration and management of the entire modular server system. This module is not redundant but the system will continue to operate normally if this module fails. However, any changes to the system configuration will not be recognized until the failed management module is replaced.

Main Cooling Modules

Two hot-swap main cooling modules are installed on the left rear of the chassis. Each module contains a redundant fan. Main cooling modules maintain separate zones in the chassis. Both modules are required to properly cool all compute modules.

Front Chassis Connectors and Indicators

The indicator modes for the Hard Drive Carrier, I/O Cooling Module, and Chassis indicators illustrated in the following figures are described in “Diagnostic LED Information” on page 165.

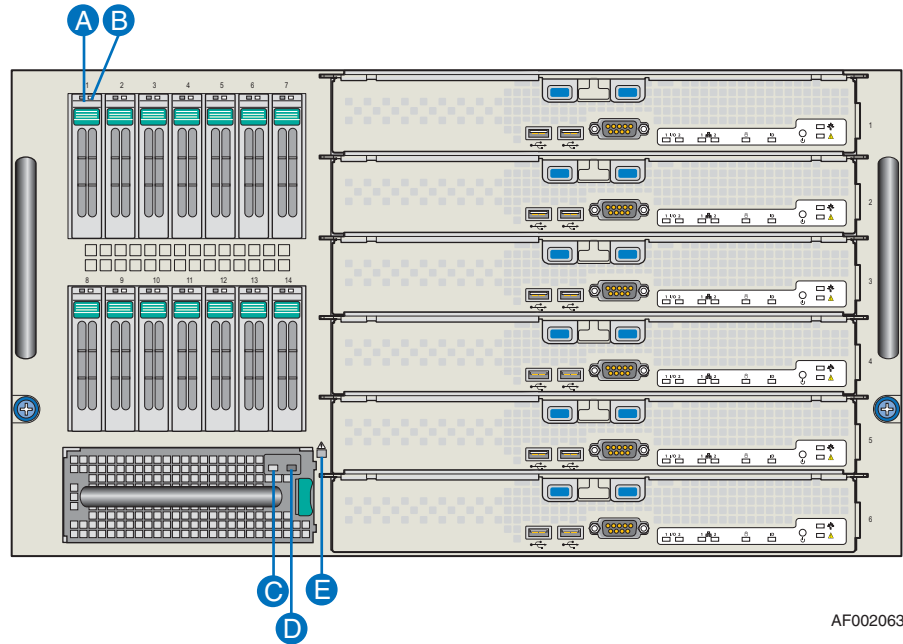

AF002063

| Hard Drive Carrier | |
|--------------------|---------------------------------------|
| A | Hard drive power/activity LED – Green |
| B | Hard drive fault LED – Amber |
| I/O Cooling Module | |
| C | I/O cooling module power LED – Green |
| D | I/O cooling module fault LED – Amber |
| Chassis | |
| E | System Fault LED - Amber |

Figure 4. Intel® Modular Server System MFSYS25V2 Front Chassis Connectors and Indicators

Compute Module Connectors and Indicators

For detailed information on compute module connectors and indicators, refer to the appropriate compute module *Technical Product Specification* and *User Guide*.

Back Chassis Connectors and Indicators

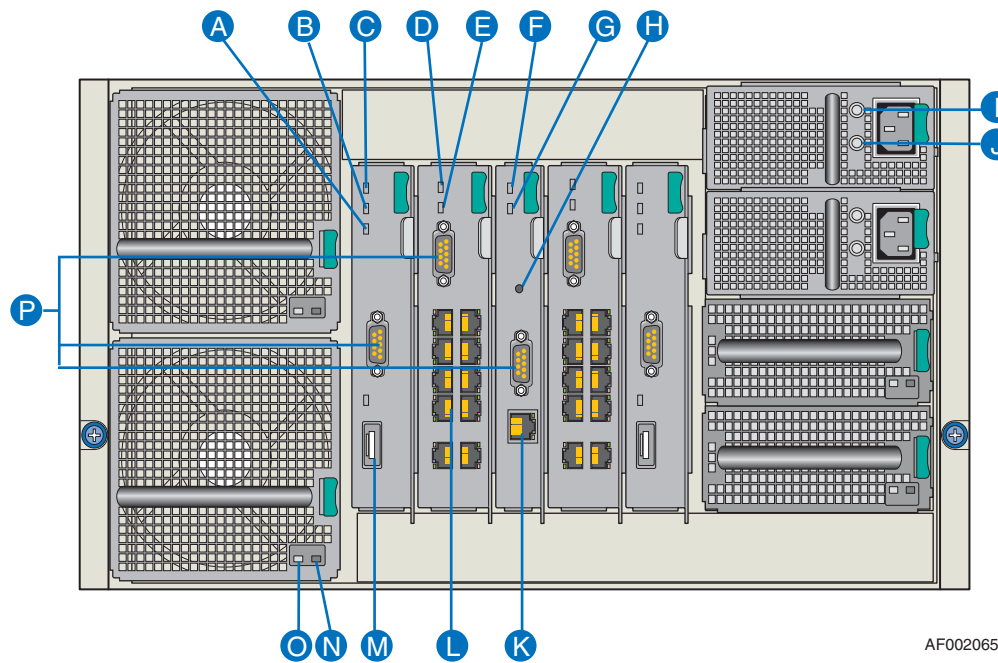

AF002065

| Storage Control Module | |
|-------------------------------|--|
| A | Storage control module dirty cache LED – Green |
| B | Storage control module fault LED – Amber |
| C | Storage control module power LED – Green |
| M | Storage control module Ethernet SAS connector |
| Ethernet Switch Module | |
| D | Ethernet switch module power LED – Green |
| E | Ethernet switch module fault LED – Amber |
| L | Ethernet switch module 1-Gb Ethernet connectors (10) with LEDs |
| P | Serial cable connectors (manufacturing only) |
| Management Module | |
| F | Management module power LED – Green |
| G | Management module fault LED – Amber |
| H | Management module reset switch |
| K | Management module NIC connectors with LEDs |
| Power Supply Module | |
| I | Power supply module power LED – Green |
| J | Power supply fault indicator LED – Amber |
| Main Cooling Module | |
| N | Main cooling module fault LED – Amber |
| O | Main cooling module power LED – Green |

Figure 5. Rear Chassis Connectors and Indicators

All indicator modes are described in “[Diagnostic LED Information](#)” on page 165.

Rack Mount Options

Your Intel® Modular Server System MFSYS25V2 can be mounted into a 4-post fixed mount rack.

2 Hardware Installations and Upgrades

Before You Begin

Before working on your server system, review the safety and ESD information at the beginning of this manual and in the appendices.

Tools and Supplies Needed

- Phillips* (cross head) screwdriver (#1 bit and #2 bit)
- Needle-nosed pliers
- A ruler
- Pen or pencil
- Anti-static wrist strap and conductive foam pad (recommended)

Chassis References

All references to left, right, front, top, and bottom are based on the reader facing the front of the chassis as it would be positioned for normal operation.

Installing the Intel® Modular Server System MFSYS25V2 in a Rack

The Intel® Modular Server System MFSYS25V2 is designed for fixed mount rack installation only; all service events will be performed from either the front or back of the system.

Caution: *When removing the system from its packaging, DO NOT lift the system by the power supply or fan module handles.*

Installation Guidelines

- Review the safety and ESD information at the beginning of this manual and in the appendices.
- Use a mechanical lift to install the Intel® Modular Server System MFSYS25V2 in a rack cabinet.
- When lifting the system, DO NOT lift by the power supply or fan module handles.
- All compute modules, hard drives, power supply modules, I/O modules, and cooling modules should be removed before placing the Intel® Modular Server System MFSYS25V2 in a rack.

- The Intel® Modular Server System MFSYS25V2 can only be installed in a rack cabinet with perforated front and rear doors.
- Plan device installation starting with the bottom of the rack cabinet.
- Do not leave unused space within the rack cabinet opening; blank filler panels must be used to fill gaps and prevent recirculation of warm air.
- Ensure the power outlets in the rack are sufficient in quantity and load capacity to support all devices intended to be installed in the rack.

Installing Temporary Handles on System

Temporary handles are provided with your Intel® Modular Server System. These handles are intended to aid in the movement of the system during removal from packaging and during initial configuration and installation. However, the profile of the handles is such that it prevents their use when the system is installed in a standard 19-inch rack.

To install the temporary handles on the system, follow these steps:

1. Mount the handles to the top edges of both the front and rear of the system.
2. Insert the handle tabs of each front and rear handle into the chassis slots and tighten captive screws.

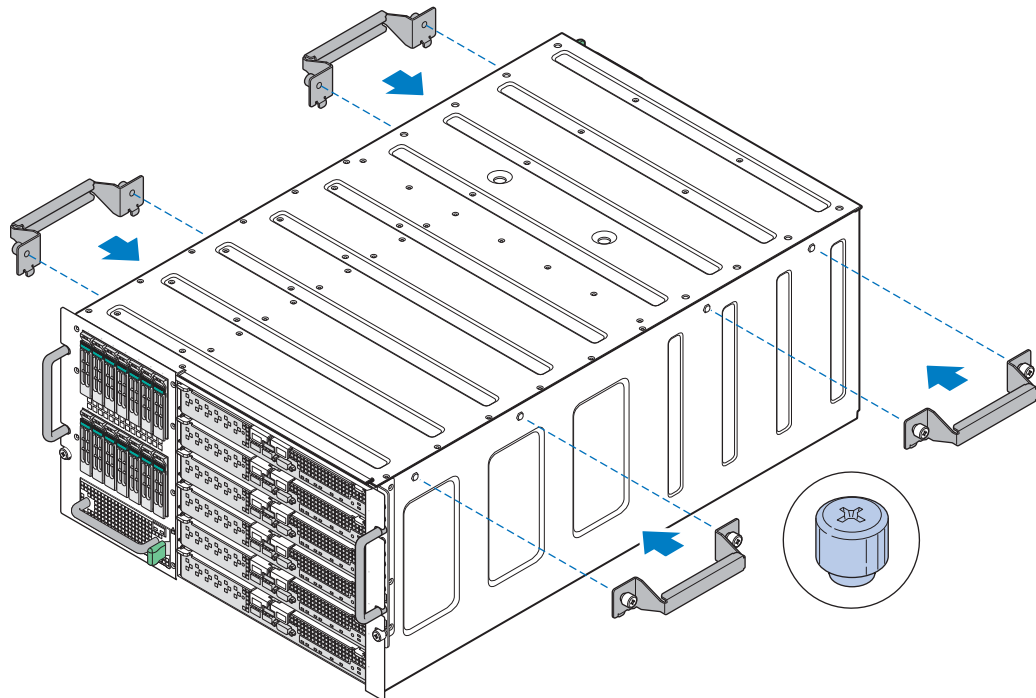

AF002418

Figure 6. Installing Temporary Handles

The system can now be moved as required to aid in removal from packaging, installation of the remaining modules in the system, or installation of the system in a rack.

Warning: *If using the handles during rack installation, the rear handles must be removed prior to setting the system on the rack rails to avoid interference of the handles with the rack. The front handles must also be removed before sliding the system completely into the rack and securing the front chassis tabs to the rack.*

Mounting System in Rack

Please read the safety information at the beginning of this book before installing the chassis in a rack.

Warning: *If you have installed temporary handles to aid in moving and/or configuring the system, you must remove the rear handles prior to setting the system on the rack rails to avoid interference of the handles with the rack. The front handles must also be removed before sliding the system completely into the rack and securing the front chassis tabs to the rack.*

1. Review the safety and ESD information at the beginning of this manual and in the appendices.
2. Identify the location within the rack where the server system is to be installed.
3. Install the rack mount rails as described in the rail installation instructions.
4. Remove the compute modules, hard drives, power supply modules, I/O modules, and cooling modules.
5. Working with at least two people, slide the server system into the rack so that it rests on the rack mounting rails.
6. Secure the server system in the rack as described in the rail installation instructions.
7. Install all compute modules, hard drives, power supply modules, I/O modules, and cooling modules.

Hot-Swap Module Installation and Removal Guidelines

- The green color on components and labels in your chassis identifies hot-swap components. You can install or remove hot-swap modules and hot-plug compute modules, with some restrictions, while the server system is powered on.
- You do not need to disconnect the server system from power to install or replace any of the hot-swap modules; however, to avoid data corruption, you must shut down the operating system and power off the compute module before removing it from the server system.
- Hot-swap cooling modules must be replaced within one minute. All other hot-swap and hot-plug components must be replaced within two minutes. Compute modules, management modules, switch modules, storage control modules, power modules, and cooling modules should be replaced with a like component or a filler panel within two minutes.

Replacing the Management Module

The Intel® Modular Server System MFSYS25V2 ships with a management module pre-installed in the middle bay of the rear of the chassis. The middle bay is dedicated to the management module and is labeled CMM. For the exact location of the management module bay, see [Figure 3](#).

The management module can only be installed in a module bay that is designed to support that device type. If necessary, the management module may be removed and replaced using the steps detailed in the following sections:

- “[Removing the Management Module](#)” on page 16
- “[Installing the Management Module](#)” on page 17

Removing the Management Module

To remove the management module, follow these steps:

1. Review the safety and ESD information at the beginning of this manual and in the appendices.
2. Remove the Ethernet cable from the management module.
3. Press the retention latch (see letter “A” in [Figure 7](#)) to release the retention lever.
4. Rotate the lever out and away from the module bay (see letter “B” in [Figure 7](#)) and pull the module straight out the back of the chassis (see letter “C” in [Figure 7](#)).

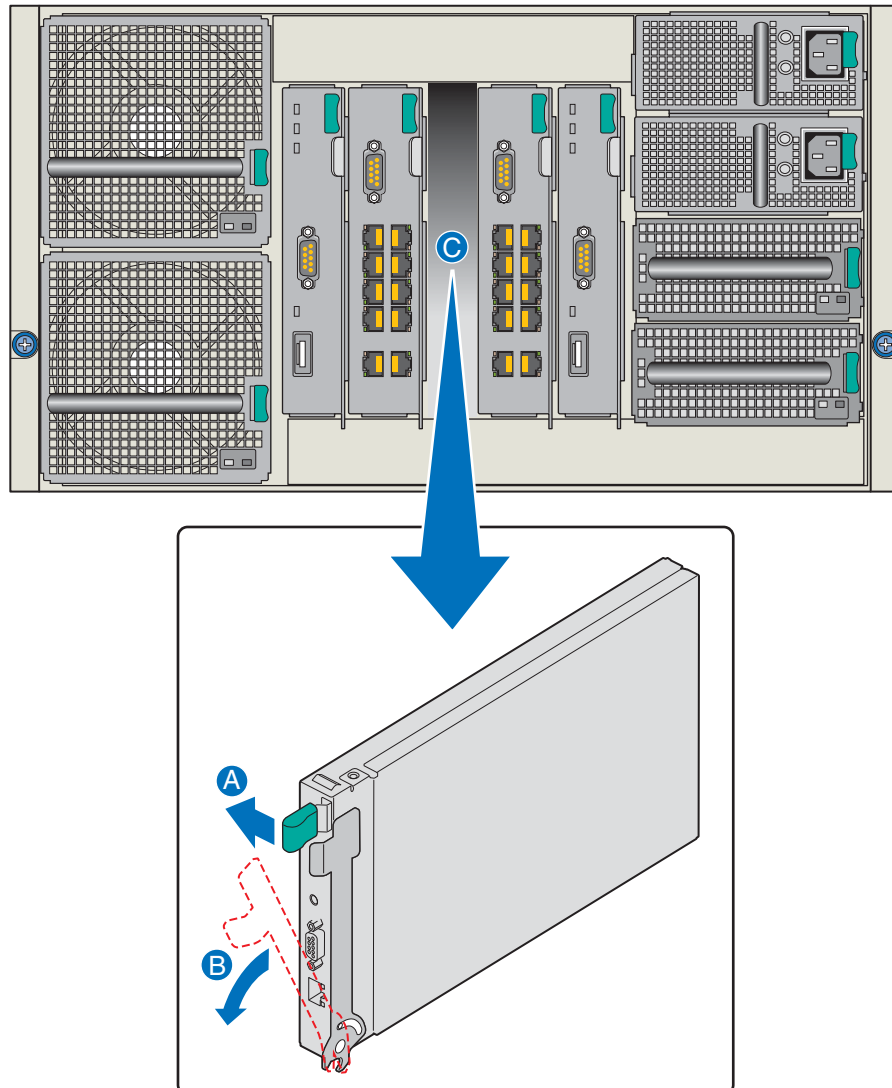

AF002436

Figure 7. Removing the Management Module

5. Install another management module in the management module bay within two minutes.

Installing the Management Module

To install the management module, follow these steps:

1. Review the safety and ESD information at the beginning of this manual and in the appendices.
2. Locate the management module bay and remove the module to be replaced.

3. Release and rotate the module retention lever out and away from the replacement management module (see letter “A” in Figure 8).
4. Slide the replacement management module into the management module bay (see letter “B” in Figure 7) until the bottom of the retention lever engages with the module bay.

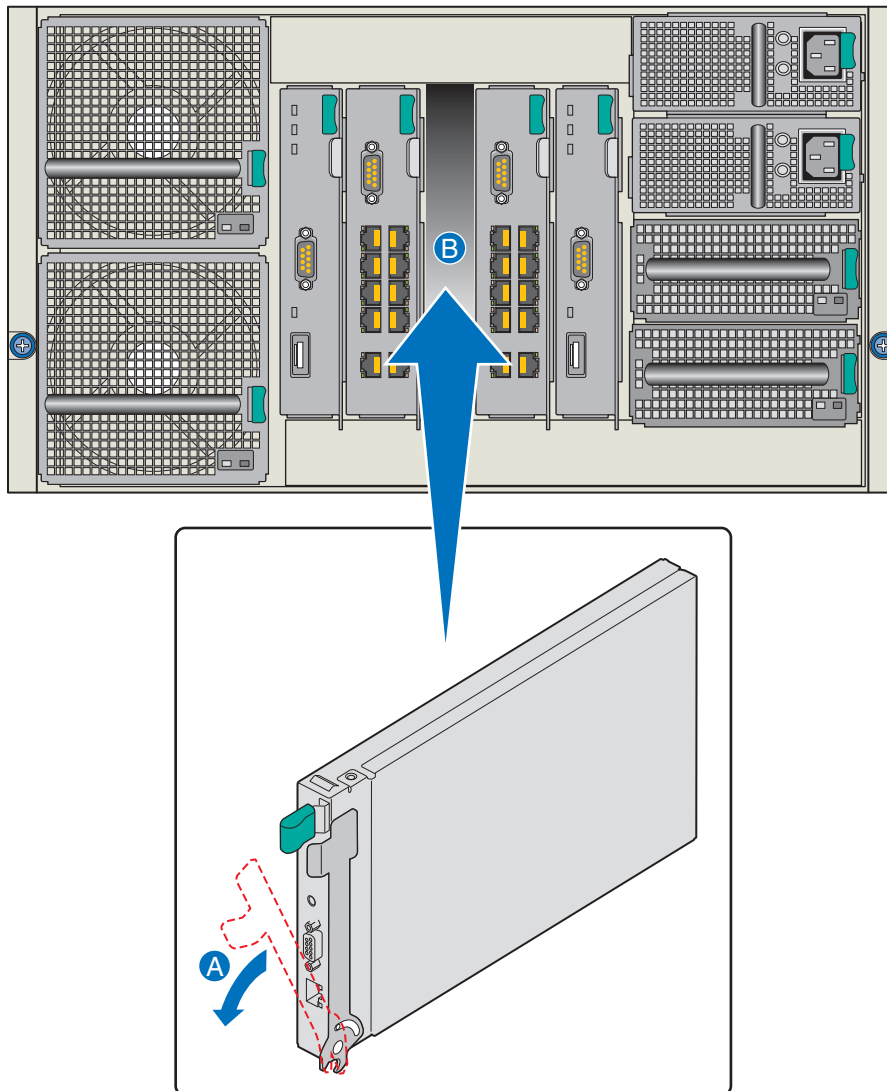

AF002414

Figure 8. Installing the Management Module

5. Rotate the lever handle in toward the module bay until it is latched.
6. Reconnect the Ethernet management port to the management network.

Installing and Removing an Ethernet Switch Module

The Intel® Modular Server System MFSYS25V2 ships with one Ethernet switch module pre-installed. Optionally, a second switch module may be installed in the second switch module bay. An ethernet switch module can only be installed in a module bay that is designed to support that device type. The two bays located immediately to the left and right of the Management Module are dedicated to the Ethernet Switch Modules and are labeled ESM. For the exact location of the switch module bay, see [Figure 3](#).

The Ethernet switch module may be removed and installed using the steps detailed in the following sections:

- “Installing an Ethernet Switch Module” on page 19
- “Removing an Ethernet Switch Module” on page 20

Installing an Ethernet Switch Module

To install an ethernet switch module, follow these steps:

1. Review the safety and ESD information at the beginning of this manual and in the appendices.
2. Locate an available switch bay and remove any installed module or filler panel.
3. Release and rotate the module retention lever out and away from the switch module (see letter “A” in [Figure 9](#)).
4. Slide the switch module into the selected module bay (see letter “B” in [Figure 9](#)) until the bottom of the retention lever engages the bay.

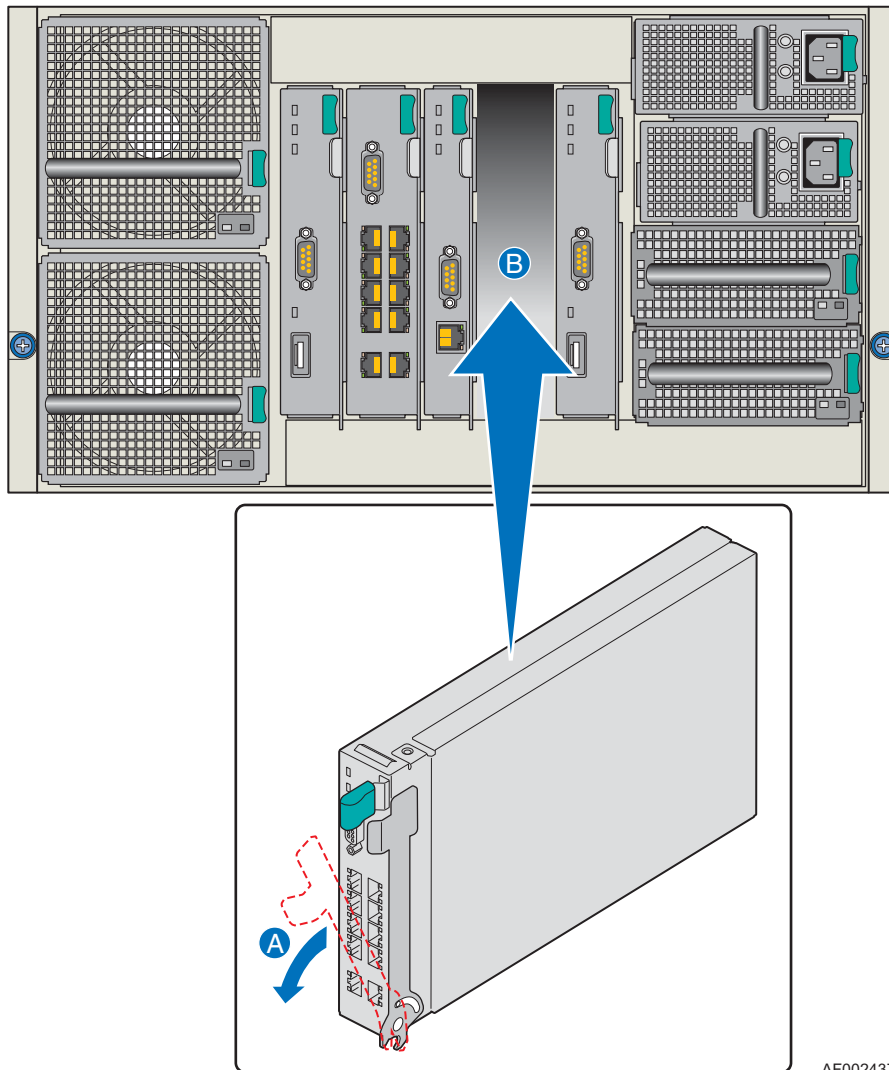

AF002437

Figure 9. Installing an Ethernet Switch Module

5. Rotate the lever handle in toward the module bay until it is latched.
6. Connect one or more Ethernet switch ports to your network as is appropriate.

Removing an Ethernet Switch Module

To remove an ethernet switch module, follow these steps:

1. Review the safety and ESD information at the beginning of this manual and in the appendices.
2. Remove and label the connected Ethernet cables, as necessary.
3. Press the retention latch (see letter “A” in [Figure 10](#)) to release the retention lever.
4. Rotate the lever out and away from the module bay (see letter “B” in [Figure 10](#)) and pull the module straight out the back of the chassis (see letter “C” in [Figure 10](#)).

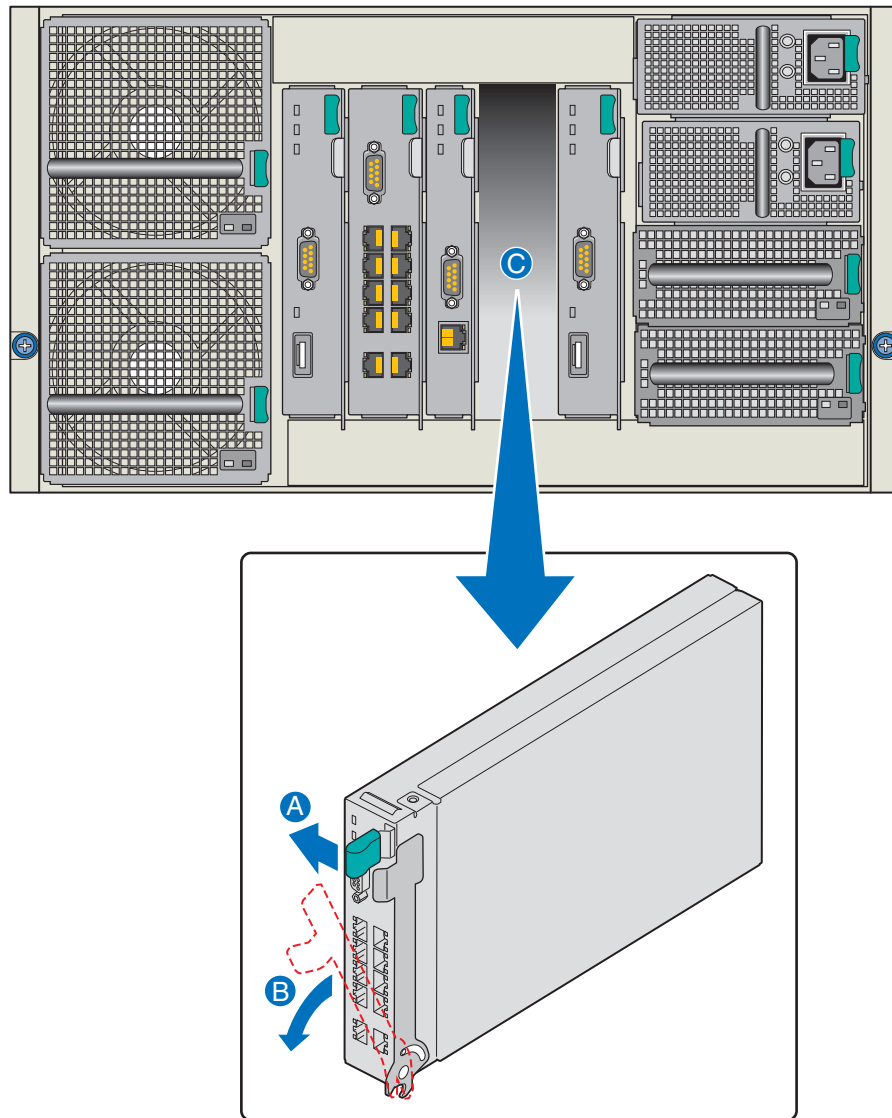

AF002413

Figure 10. Removing an Ethernet Switch Module

5. Install a filler panel or another Ethernet switch module in the switch module bay within two minutes.

Installing and Removing a Storage Control Module

The Intel® Modular Server System MFSYS25V2 ships with one storage control module pre-installed. Optionally, a second storage control module may be installed in the open storage control module bay. A Storage Control module can only be installed in a module bay that is designed to support that device type. The farthest bay on the left and the farthest bay on the right are dedicated to the Storage Control Modules and are labeled SCM. For the exact location of the storage control module bay, see [Figure 3](#).

The Storage Control module may be removed and installed using the steps detailed in the following sections:

- “Installing a Storage Control Module” on page 22
- “Removing a Storage Control Module” on page 23

Installing a Storage Control Module

To install a storage control module, follow these steps:

1. Review the safety and ESD information at the beginning of this manual and in the appendices.
2. Locate an available storage control module bay and remove any installed module or filler panel.
3. Release and rotate the module retention lever out and away from the storage control module (see letter “A” in [Figure 11](#)).
4. Slide the storage control module into the selected module bay (see letter “B” in [Figure 11](#)) until the bottom of the retention lever engages with the module bay.

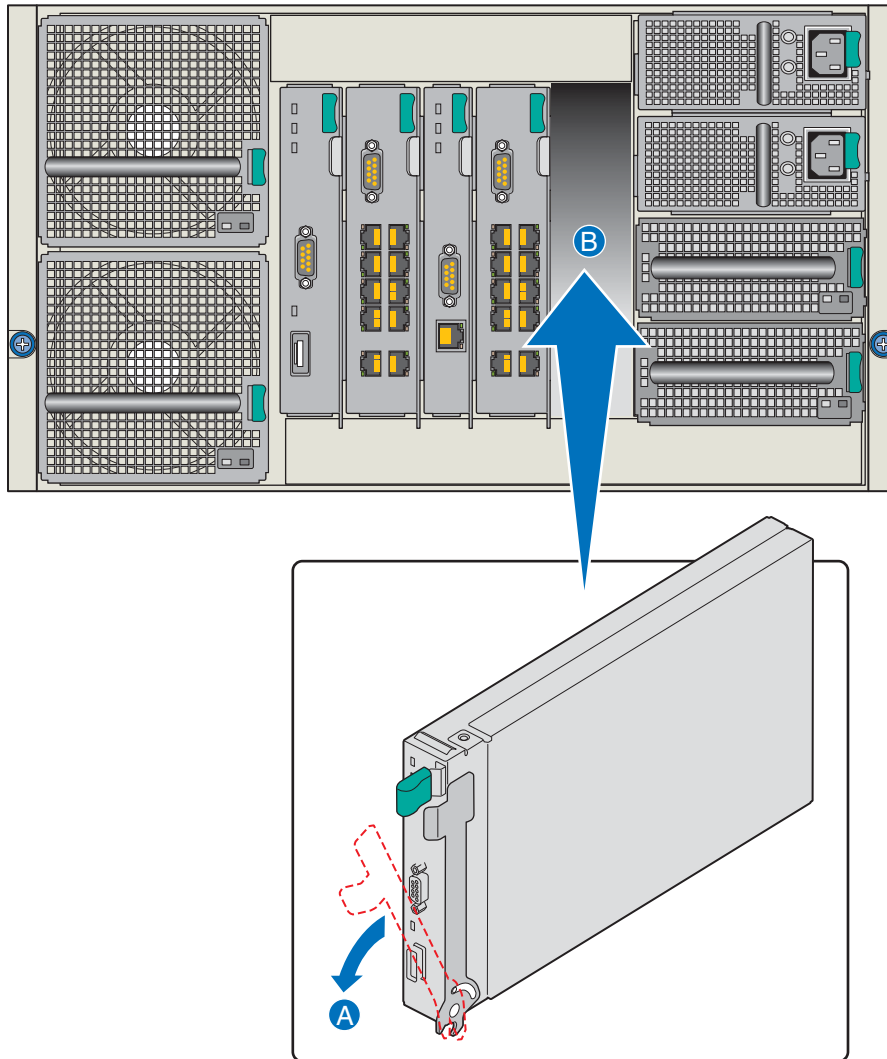

AF002412

Figure 11. Installing a Storage Control Module

5. Rotate the lever handle in toward the module bay until it latches.

Removing a Storage Control Module

If only one Intel® Storage Control Module is installed in the Intel® Modular Server System, power off all compute modules prior to removing the Intel® Storage Control Module

To remove a storage control module, follow these steps:

1. Review the safety and ESD information at the beginning of this manual and in the appendices.

2. Press the retention lever latch button to release the retention lever (see letter “A” in Figure 12).
3. Rotate the lever out and away from the module bay (see letter “B” in Figure 12) and pull the storage control module straight out the back of the chassis (see letter “C” in Figure 12).

Warning: You must replace the storage control module with a filler panel or another storage control module within two minutes.

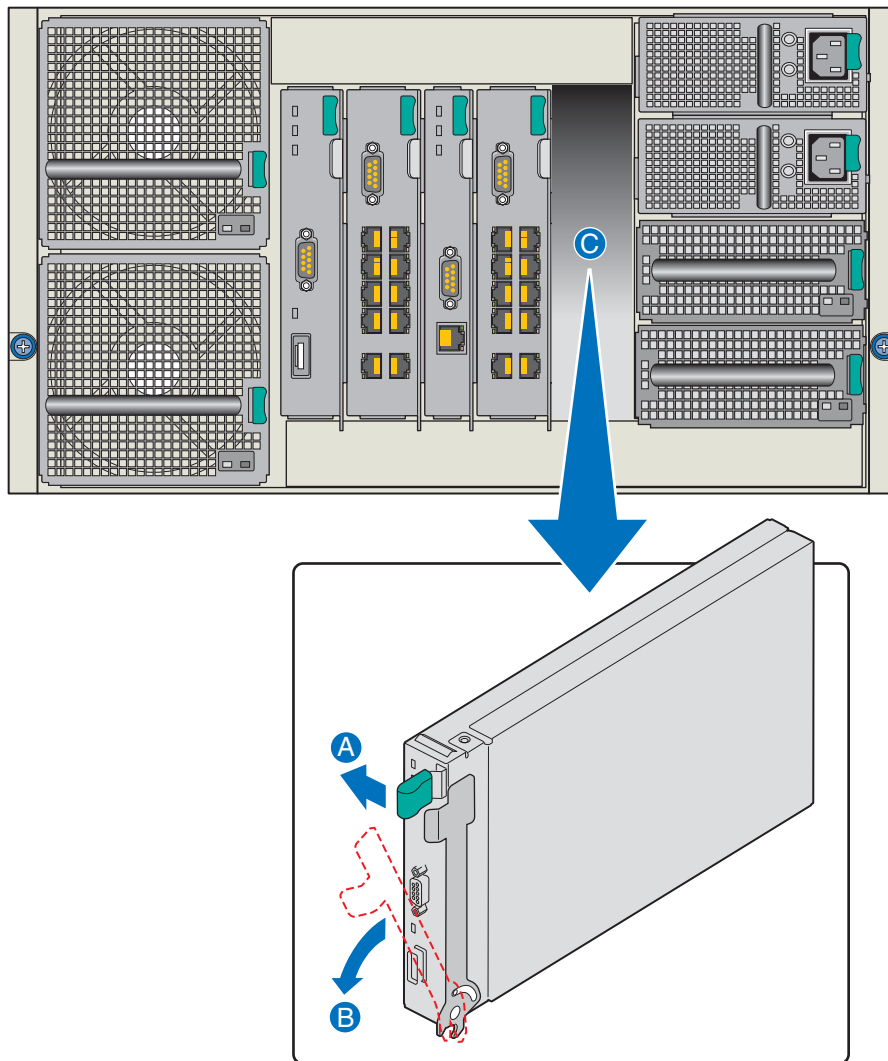

AF002430

Figure 12. Removing a Storage Control Module

4. Install a filler panel or another storage control module in the storage control module bay within two minutes.

Installing and Removing the Backup Battery

Installing a Backup Battery

To install a backup battery, follow these steps:

1. Review the safety and ESD information at the beginning of this manual and in the appendices.
2. Remove the storage control module from the system. For instructions, see “[Removing a Storage Control Module](#)” on page 23.

Warning: *You must replace the storage control module with a filler panel or another storage control module within two minutes.*

3. Place the storage control module sideways on a work surface so that its largest surface area is touching the work surface and the retention lever is on the top.
4. With a Phillips* screwdriver, remove the screw securing the top cover to the storage control module (see letter “A” in [Figure 13](#)).

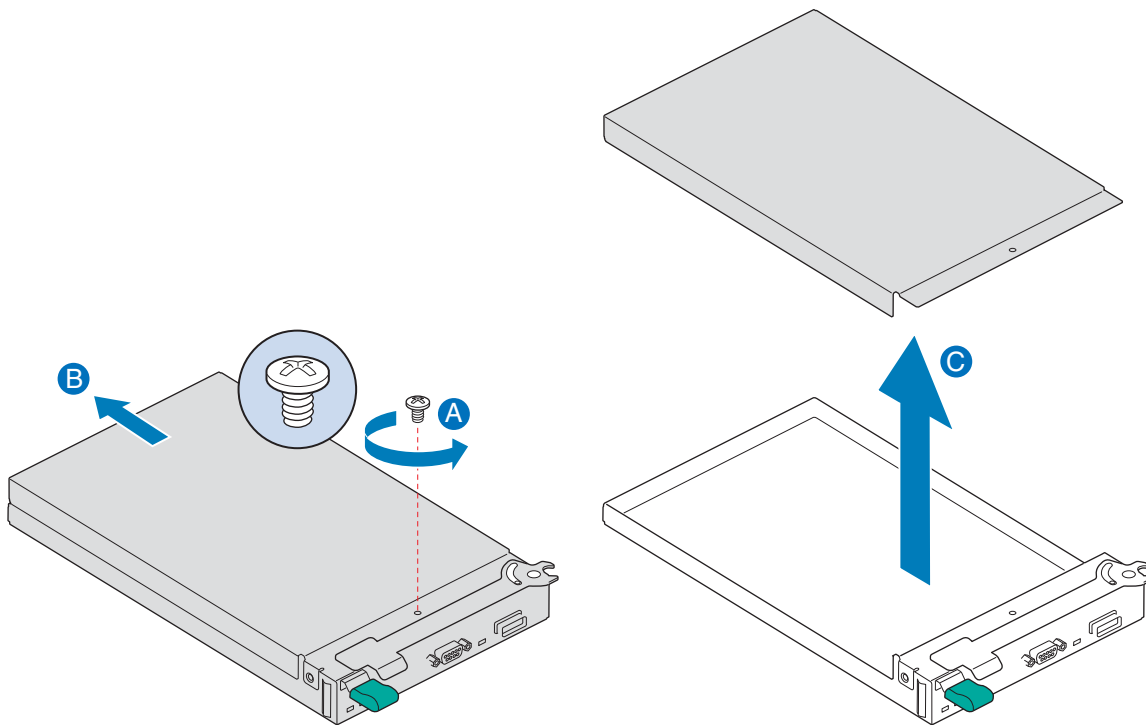

AF002563

Figure 13. Removing Top Cover from Storage Control Module

5. Slide the cover towards the rear of the storage control module (see letter “B” in [Figure 13](#)) and lift upward (see letter “C” in [Figure 13](#)).

6. Install the backup battery in the black plastic battery holder (see letter “A” in [Figure 14](#)). Connect the battery cable to the battery connector on the printed circuit board (see letter “B” in [Figure 14](#)).

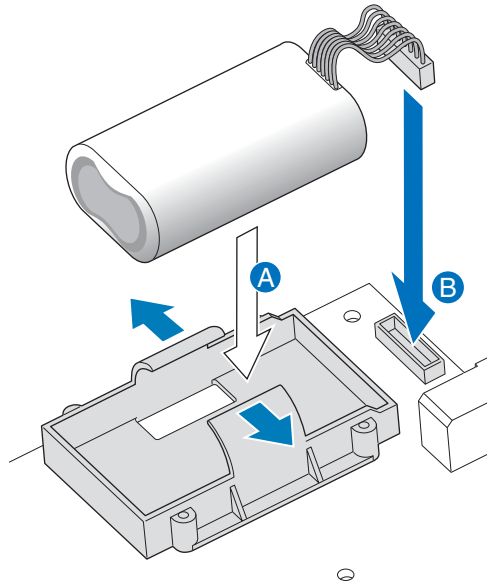

AF002440

Figure 14. Installing Backup Battery

7. Align notches in the top cover with corresponding tabs in the storage control module. Slide the top cover forward to close.
8. Secure the top cover to the storage control module with the two screws previously removed.
9. Re-install the storage control module in the server system. For instructions, see [“Installing a Storage Control Module” on page 22](#).

Removing a Backup Battery

To remove a backup battery, follow these steps:

1. Review the safety and ESD information at the beginning of this manual and in the appendices.
2. Remove the storage control module from the system. For instructions, see [“Removing a Storage Control Module” on page 23](#).

Warning: *You must replace the storage control module with a filler panel or another storage control module within two minutes.*

3. Place the storage control module sideways on a work surface so that its largest surface area is touching the work surface and the retention lever is on the top.
4. With a Phillips* screwdriver, remove the screw securing the top cover to the storage control module (see letter “A” in Figure 15).

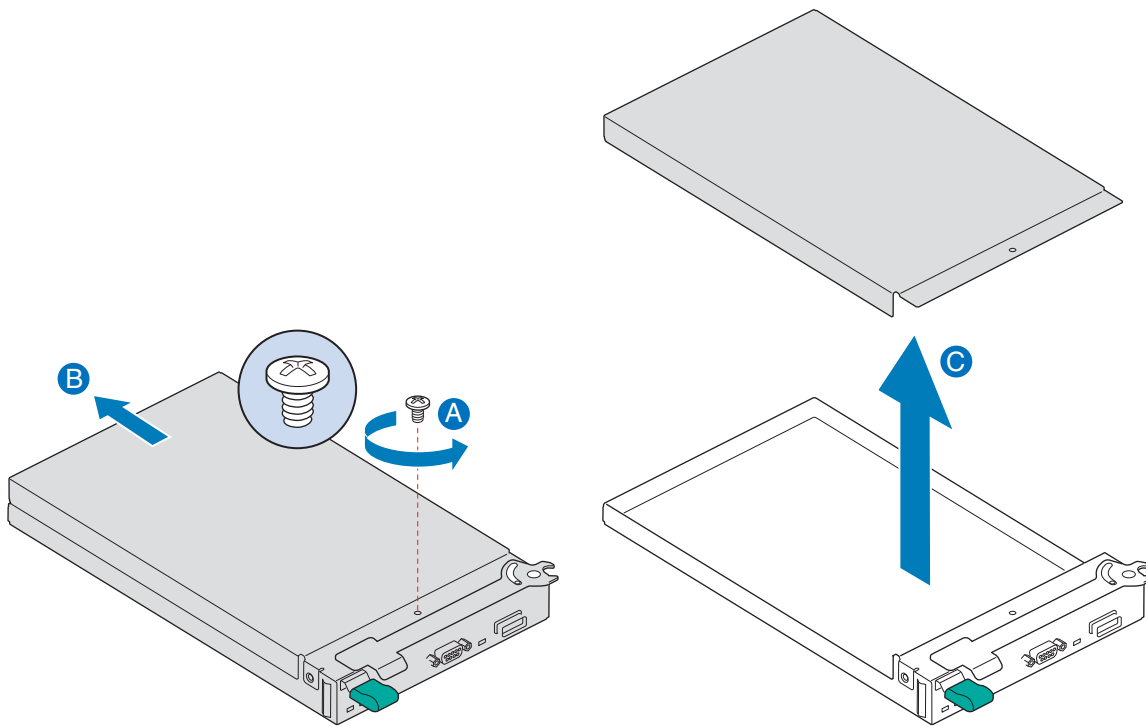

AF002563

Figure 15. Removing Top Cover from Storage Control Module

5. Slide the cover towards rear of the storage control module (see letter “B” in Figure 15) and lift upward (see letter “C” in Figure 15).

6. Disconnect the battery cable from the battery connector on the printed circuit board (see letter “A” in [Figure 16](#)). Remove the battery from the black plastic battery holder (see letter “B” in [Figure 16](#)).

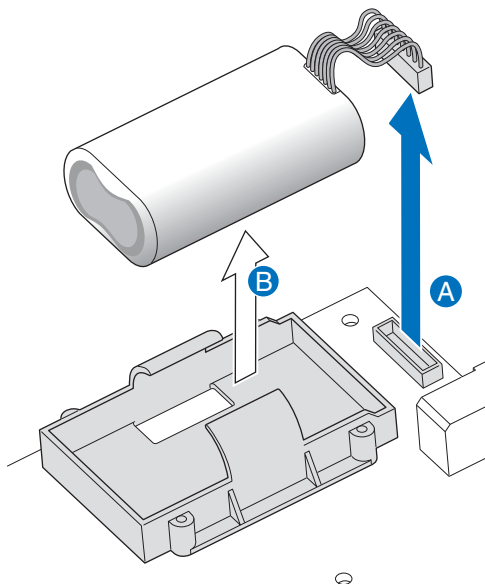

AF002461

Figure 16. Removing Backup Battery

7. Align notches in the top cover with corresponding tabs in the storage control module. Slide the top cover forward to close.
8. Secure the top cover to the storage control module with the two screws previously removed.
9. Re-install the storage control module in the server system. For instructions, see [“Installing a Storage Control Module”](#) on page 22.

Installing and Removing a Power Supply Module

The Intel® Modular Server System MFSYS25V2 ships with two power supply modules pre-installed. A single power supply is suitable to support the power requirement for the chassis, including fan modules, storage control module, switch module, storage bay, and a single compute module. Additional power modules are required as the number of installed compute modules increases.

Note: *One power supply module supports one compute module plus all other modules in the system.*

Two power supply modules support two to three compute modules (in any slot) plus all other modules in the system.

Three power supply modules support four to six compute modules (in any slot) plus all other modules in the system.

Any additional power supply modules above the minimum required (based on configuration) provide redundancy.

Installing a Power Supply Module

To install a power supply module, follow these steps:

1. Review the safety and ESD information at the beginning of this manual and in the appendices.
2. Locate the power supply module bay and remove any installed module or filler module.
 - For instructions on removing a power supply module, see “[Removing a Power Supply Module](#)” on page 30.
 - To remove a filler module, press the retention lever latch (see letter “A” in [Figure 17](#)) to release the filler module from the module bay. Slide the filler module out of the bay (see letter “B” in [Figure 17](#)).

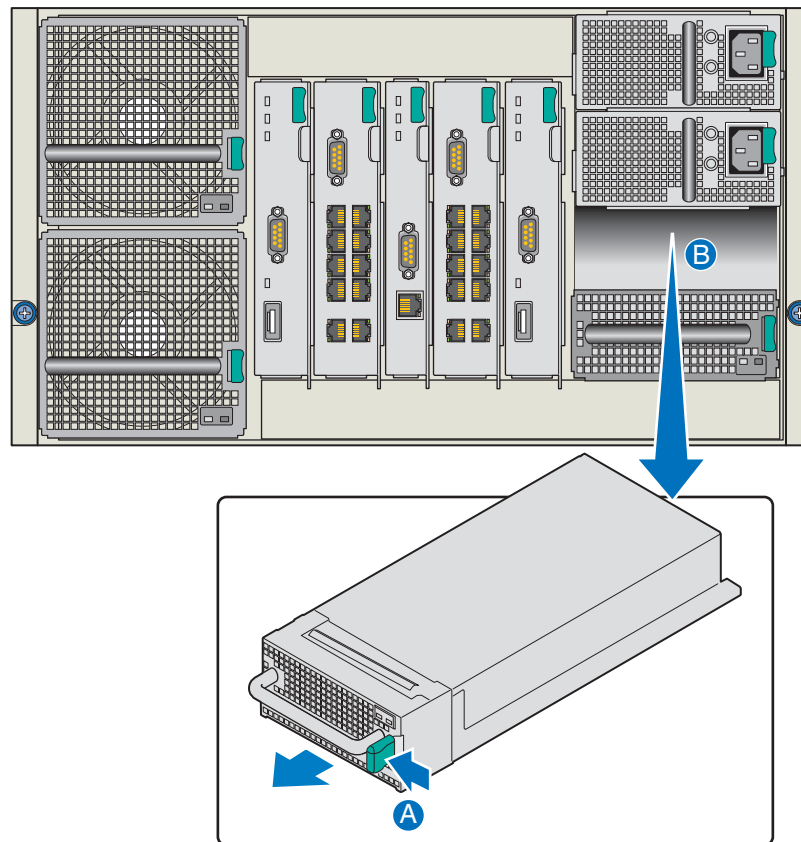

AF002420

Figure 17. Removing Filler Module

3. Slide the power supply module into the power supply module bay until the retention latch engages.

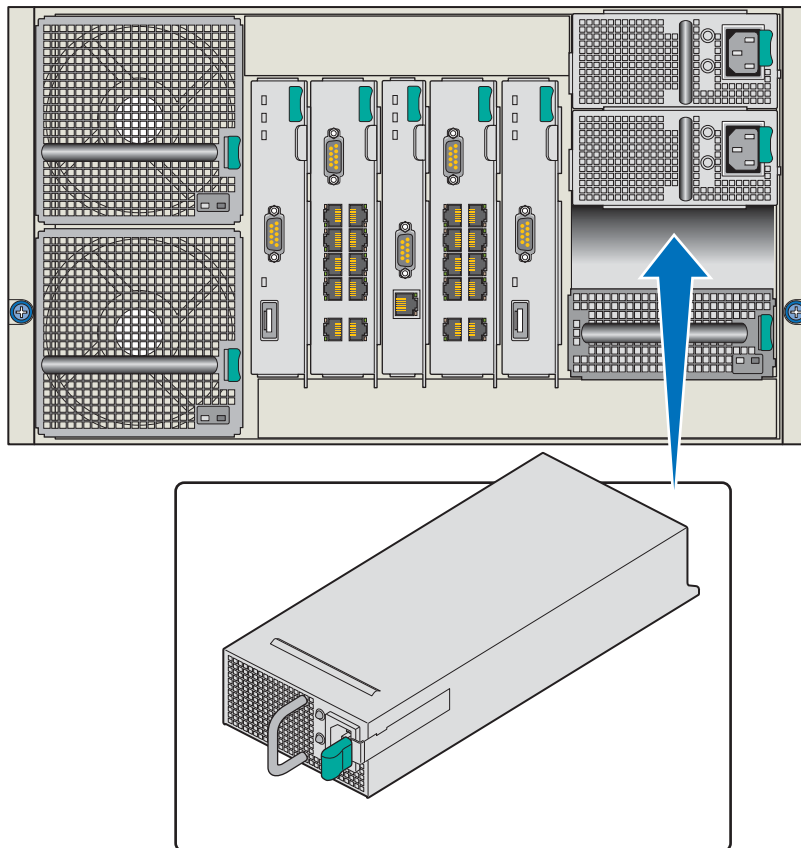

AF002434

Figure 18. Installing Power Supply Module

4. Connect a power cable from the power supply module to an appropriate power source.

Removing a Power Supply Module

To remove a power supply module, follow these steps:

1. Review the safety and ESD information at the beginning of this manual and in the appendices.
2. Locate the power supply module to be removed.
3. Remove the power cord from both the power supply module and the power source.

4. Press the power supply module retention latch to release the power supply module from the bay (see letter “A” in Figure 19). Slide the power supply module out of the module bay (see letter “B” in Figure 19).

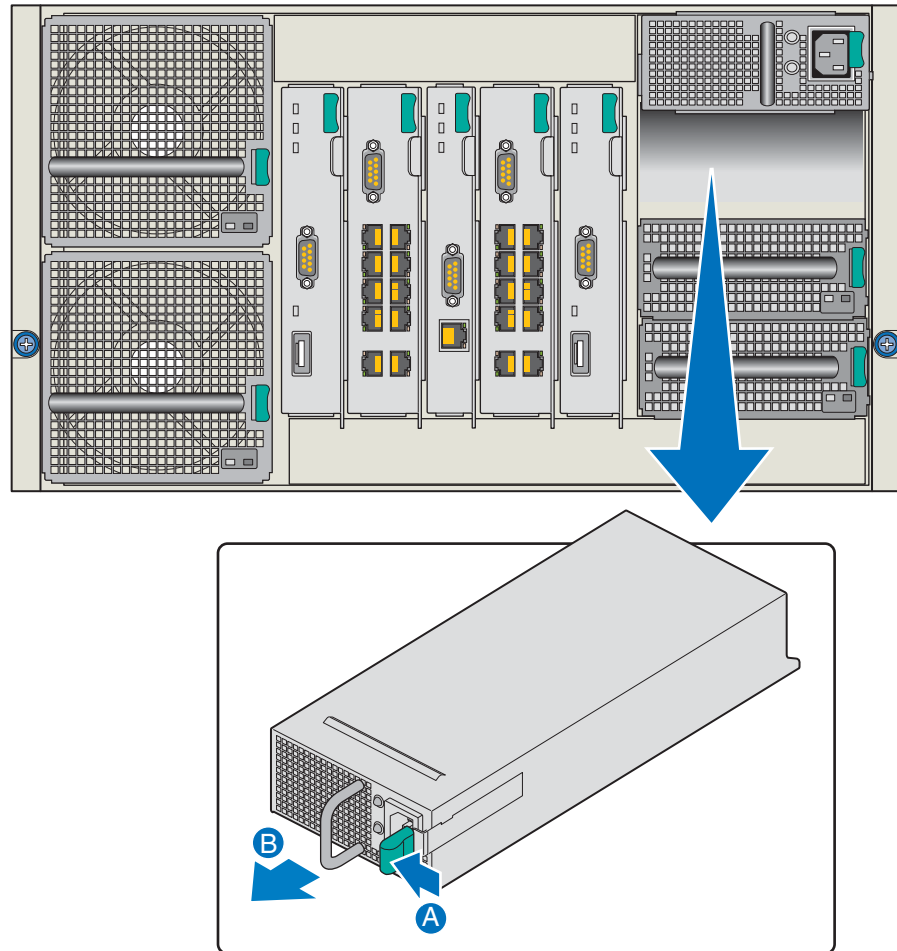

AF002433

Figure 19. Removing a Power Supply Module

5. Replace the power supply module with a filler panel or another power supply module within two minutes.

Replacing a Main Cooling Module

The Intel® Modular Server System MFSYS25V2 ships with two main cooling modules pre-installed at the back of the chassis. For the exact location of the Main Cooling Modules, see Figure 3.

Removing a Main Cooling Module

To remove a main cooling module, follow these steps:

1. Review the safety and ESD information at the beginning of this manual and in the appendices.
2. Locate the main cooling module to be replaced.
3. Press the main cooling module retention clip to release the main cooling module from the module bay (see letter “A” in Figure 20).
4. Slide the main cooling module out of the module bay (see letter “B” in Figure 20).

Warning: Replace the cooling module with another cooling module within two minutes.

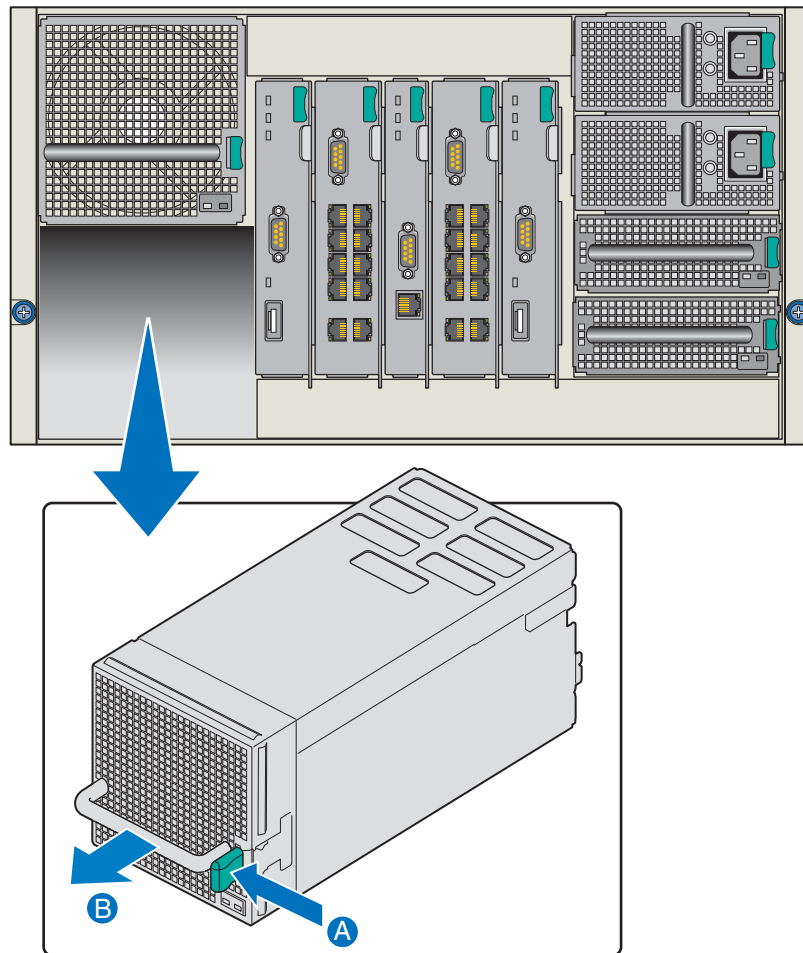

AF002438

Figure 20. Removing a Main Cooling Module

5. Install another cooling module into the cooling module bay within two minutes.

Installing a Main Cooling Module

To install a main cooling module, follow these steps:

1. Review the safety and ESD information at the beginning of this manual and in the appendices.
2. Locate the cooling module bay and remove the cooling module to be replaced.
3. Slide the replacement cooling module into the unoccupied cooling module bay until the retention latch engages (see [Figure 21](#)).

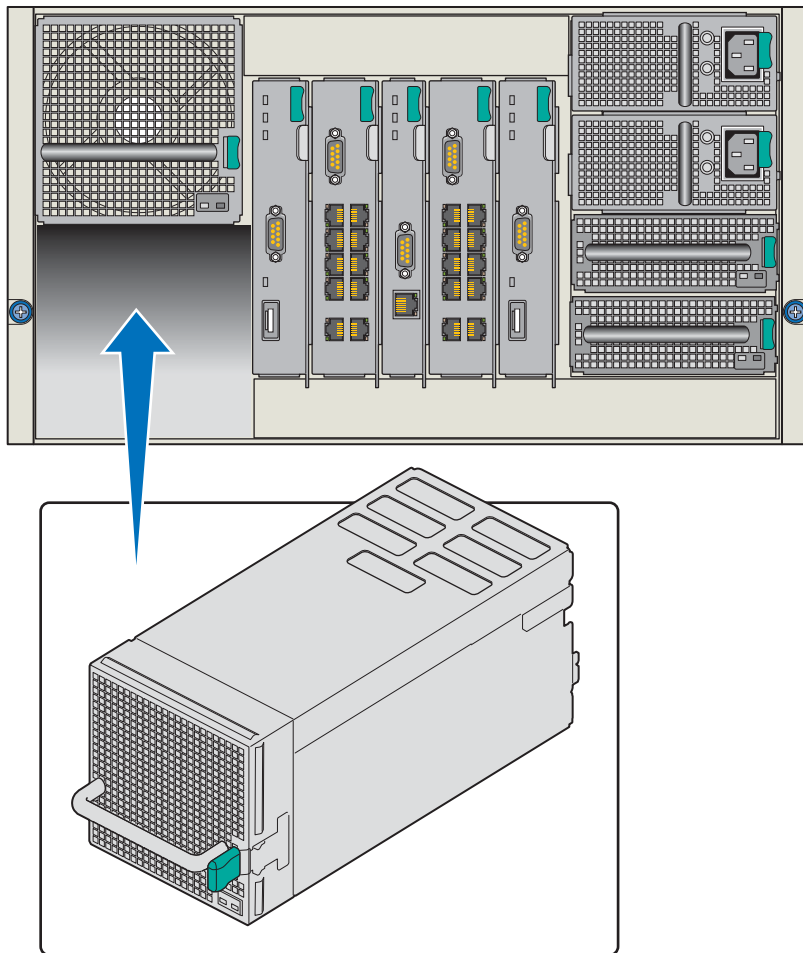

AF002439

Figure 21. Installing a Main Cooling Module

Replacing the I/O Cooling Module

The Intel® Modular Server System MFSYS25V2 ships with one I/O cooling module pre-installed at the front of the chassis. For the exact location of the I/O Cooling Module in Intel® Modular Server System MFSYS25V2, see [Figure 2](#).

Removing the I/O Cooling Module

To remove the I/O cooling module, follow these steps:

1. Review the safety and ESD information at the beginning of this manual and in the appendices.
2. Locate the I/O cooling module to be replaced.
3. Press the I/O cooling module retention latch to release the I/O cooling module from the module bay (see letter “A” in [Figure 23](#)).
4. Slide the I/O cooling module out of the module bay (see letter “B” in [Figure 23](#)).

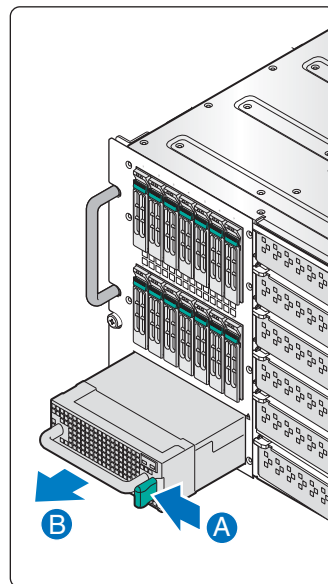

AF003160

Figure 22. Removing an I/O Cooling Module

5. Install another cooling module into the cooling module bay within two minutes.

Installing the I/O Cooling Module

To install the I/O cooling module, follow these steps:

1. Review the safety and ESD information at the beginning of this manual and in the appendices.
2. Locate the cooling module bay and remove the cooling module to be replaced.
3. Slide the replacement I/O cooling module into the vacant module bay (see [Figure 23](#)) until the retention latch engages.

Warning: Replace the cooling module with another cooling module within two minutes.

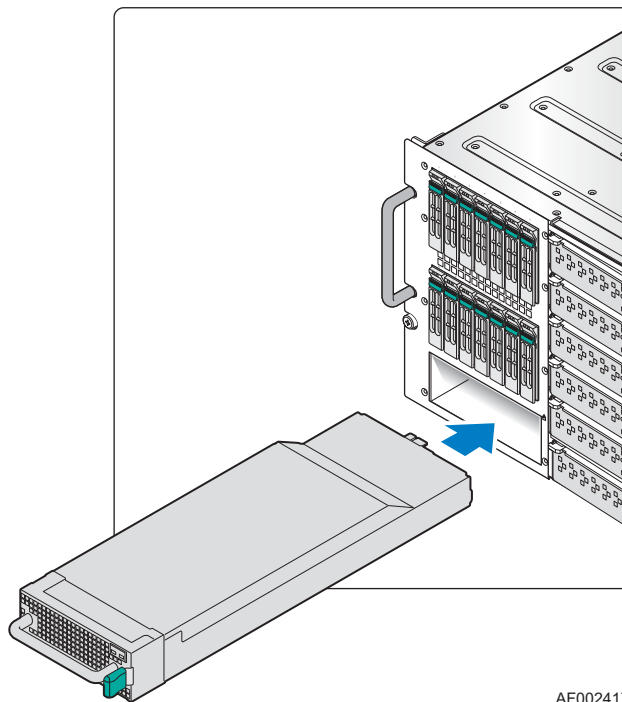

AF002417

Figure 23. Installing an I/O Cooling Module

Installing and Removing Hard Drives

The Intel® Modular Server System MFSYS25V2 provides storage for installed compute modules by way of an on-board storage bay combined with a storage management module. The on-board storage bay supports the installation of up to 14 hot-swap 2.5-inch SAS/SATA hard drives in the Intel® Modular Server System MFSYS25V2 that are configured through the integrated Intel® Modular Server Control UI. For more information, see “Using the Intel® Modular Server Control User Interface” on page 47.

Caution: Only hard drives validated for use in the Intel® Modular Server System MFSYS25V2 should be installed. You may damage the Intel® Modular Server System MFSYS25V2 if you install a hard drive that is not listed in the Intel® Modular Server System Tested Hardware and Operating System List.

Installing a 2.5-inch Hard Drive into the Storage Bay

To install a 2.5-inch hard drive into the storage bay, follow these steps:

1. Review the safety and ESD information at the beginning of this manual and in the appendices.
2. Press the retaining lever on an available drive carrier to release the drive carrier from the drive bay module (see letter “A” in Figure 24). Remove the drive carrier from the drive bay module (see letter “B” in Figure 24).

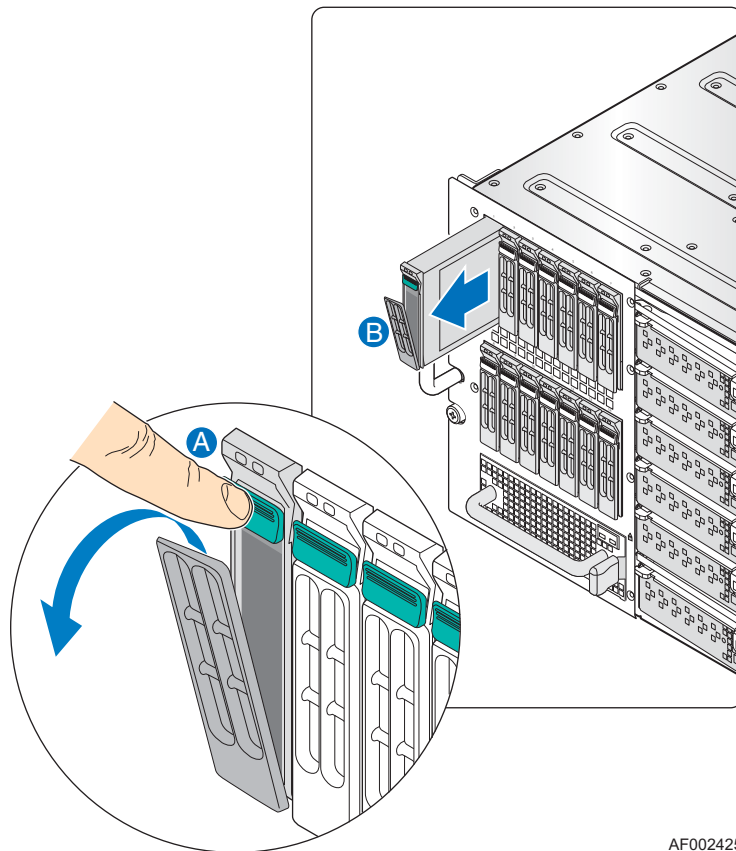

AF002425

Figure 24. Removing a 2.5-inch Drive Carrier from a Drive Bay Module

3. With a Phillips* screwdriver, remove the four screws securing the filler panel to the drive carrier.

4. Align the holes in the hard drive to the holes in the drive carrier (see letter “A” in [Figure 25](#)) and attach it to the drive carrier using the four screws removed in the previous step (see letter “B” in [Figure 25](#)).

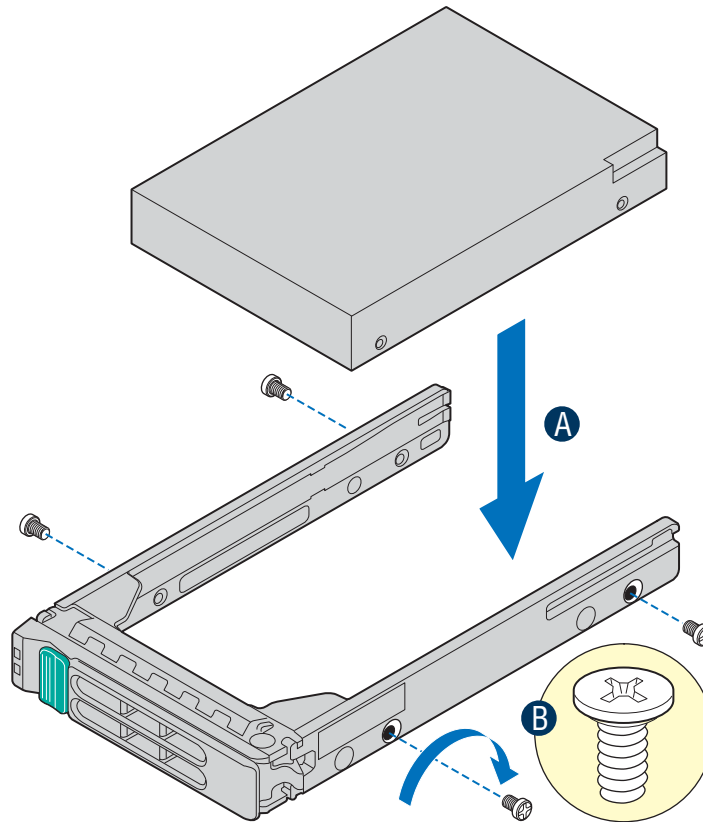

AF002428

Figure 25. Installing Hard Drive into Drive Carrier

5. For 2.5" SSD and SATA hard drives, attach the AXXTM3SATA (SATA to SAS Converter Board) to the drive. See the figure below.

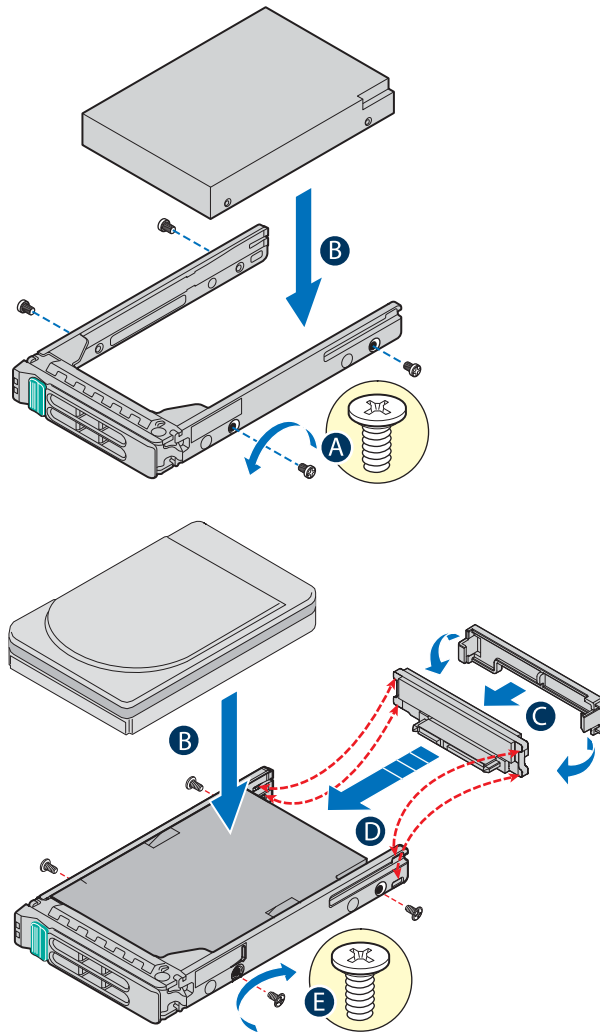
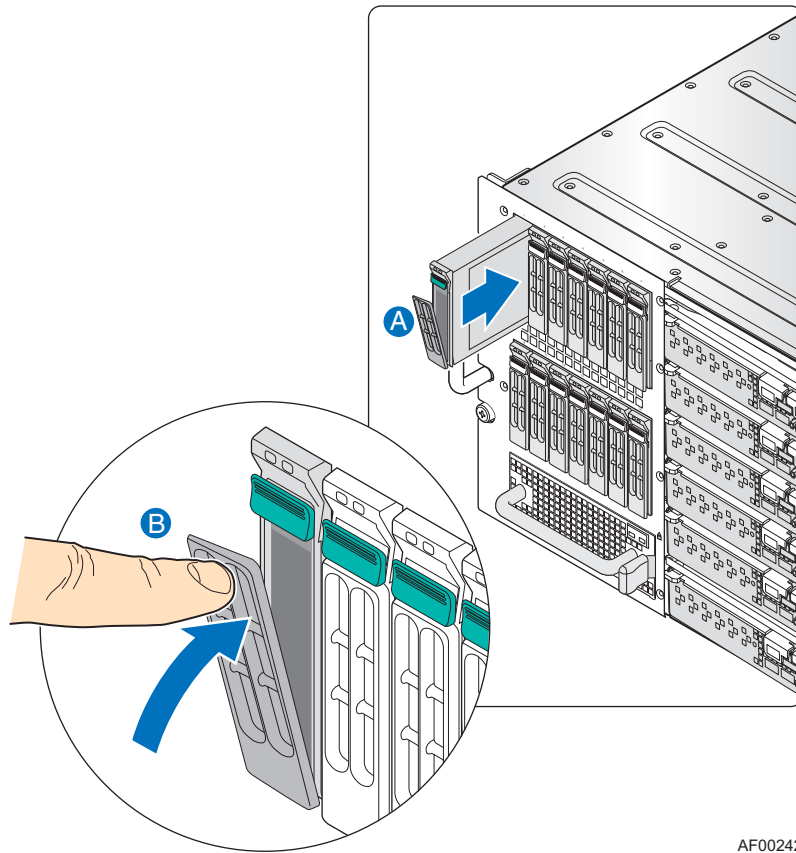

Figure 26. Attaching AXXTM3SATA to the Drive

6. With the drive carrier retaining lever in the open position (see letter “A” in [Figure 27](#)), carefully slide the drive carrier into the drive bay module until it is fully seated and the retaining lever starts to engage. Press firmly to latch the retaining lever (see letter “B” in [Figure 27](#)).



AF002426

Figure 27. Installing 2.5-inch Drive Carrier in Drive Bay Module

Removing a 2.5-inch Hard Drive from the Storage Bay

To remove a 2.5-inch hard drive from the storage bay, follow these steps:

1. Review the safety and ESD information at the beginning of this manual and in the appendices.
2. To avoid data corruption, ensure that the drive you intend to remove is not online and actively providing data storage to any of the installed compute modules.

3. Press the retaining lever on the selected drive carrier to release the drive carrier from the drive bay module (see letter “A” in [Figure 28](#)). Remove the drive carrier from the drive bay module (see letter “B” in [Figure 28](#)).

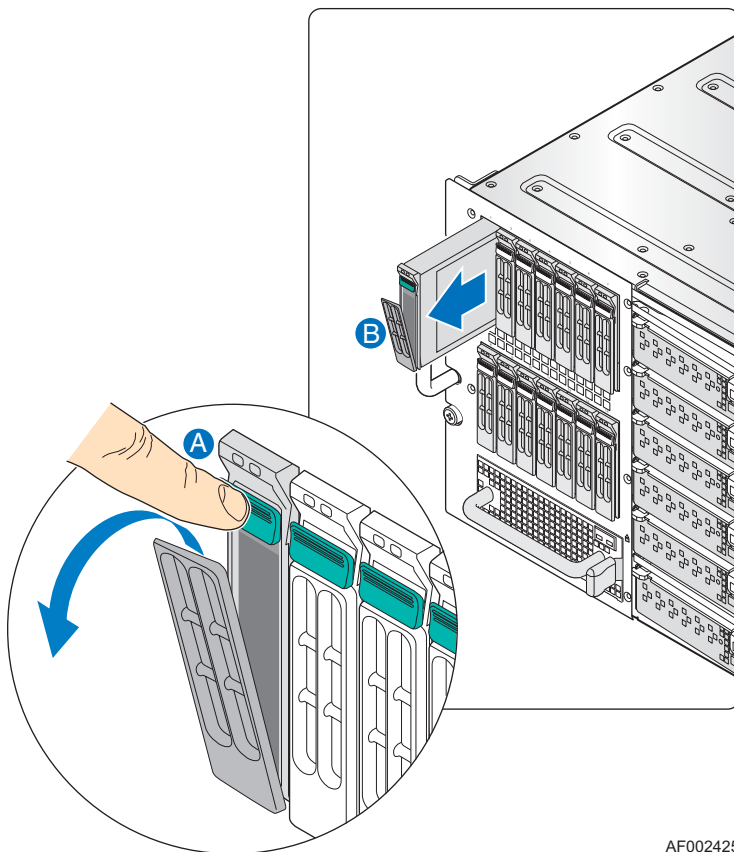

AF002425

Figure 28. Removing a 2.5-inch Drive Carrier from the Drive Bay Module

4. With a Phillips* screwdriver, remove the four screws securing the hard drive to the drive carrier (see letter “A” in Figure 29). Lift the hard drive from the carrier (see letter “B” in Figure 29) and store the hard drive in an anti-static container or bag.

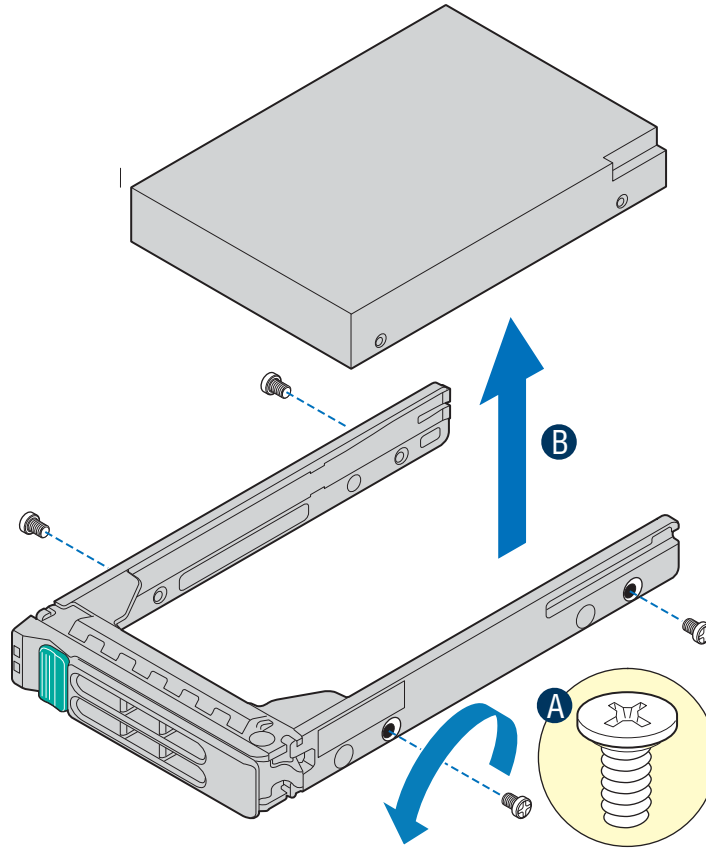

AF002429

Figure 29. Removing Hard Drive from a Drive Carrier

5. For 2.5" SSD and SATA hard drives, remove the AXXTM3SATA (SATA from SAS Converter Board) from the drive. See the figure below.

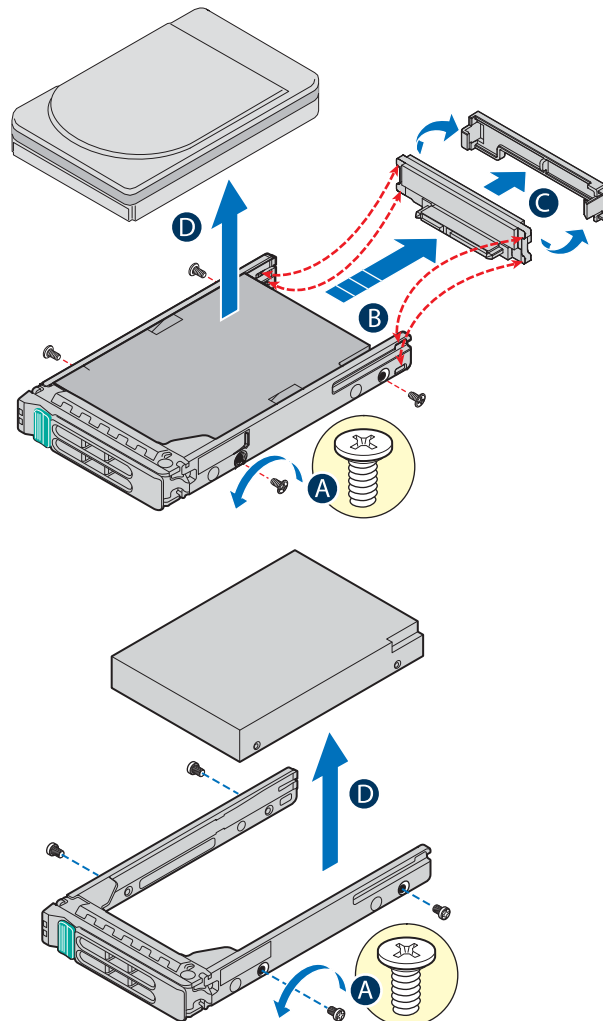

Figure 30. Removing AXXTM3SATA from the Drive

6. Install either another hot-swap hard drive or a filler blank in the drive carrier.
7. Install the drive carrier into the empty drive bay module within two minutes; this step is required to maintain proper airflow throughout the chassis and to ensure proper system cooling.

Installing and Removing an Intel® Compute Module

Installing an Intel® Compute Module

To install an Intel® Compute Module, follow these steps:

1. Review the safety and ESD information at the beginning of this manual and in the appendices.
2. If you have not done so already, install any necessary options, such as processor and memory, in the compute module.

Note: *The top cover is a required component of the compute module assembly. Do not attempt to insert a compute module into the chassis without ensuring an installed top cover is in place.*

3. Make sure the release handles on the compute module are in the open position (see letter “A” in Figure 31). Insert the compute module into an open slot in the chassis and slide it in until it stops (see letter “B” in Figure 31).

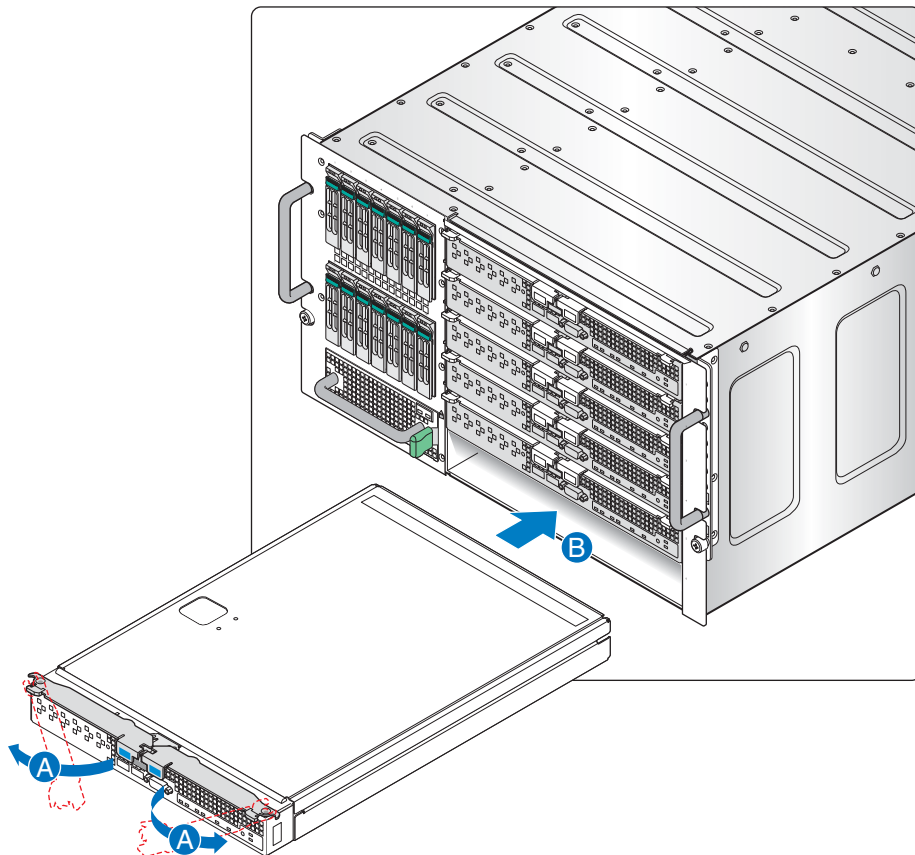

AF002431

Figure 31. Installing an Intel® Compute Module

4. Close the release handles on the front of the compute module.

Removing an Intel® Compute Module

To remove an Intel® Compute Module, follow these steps:

1. Review the safety and ESD information at the beginning of this manual and in the appendices.
2. If the compute module is operating, shut down the operating system and power it down.
3. Open the two release handles at the front of the compute module (see letter “A” in Figure 32) and pull the compute module out of the server system (see letter “B” in Figure 32).

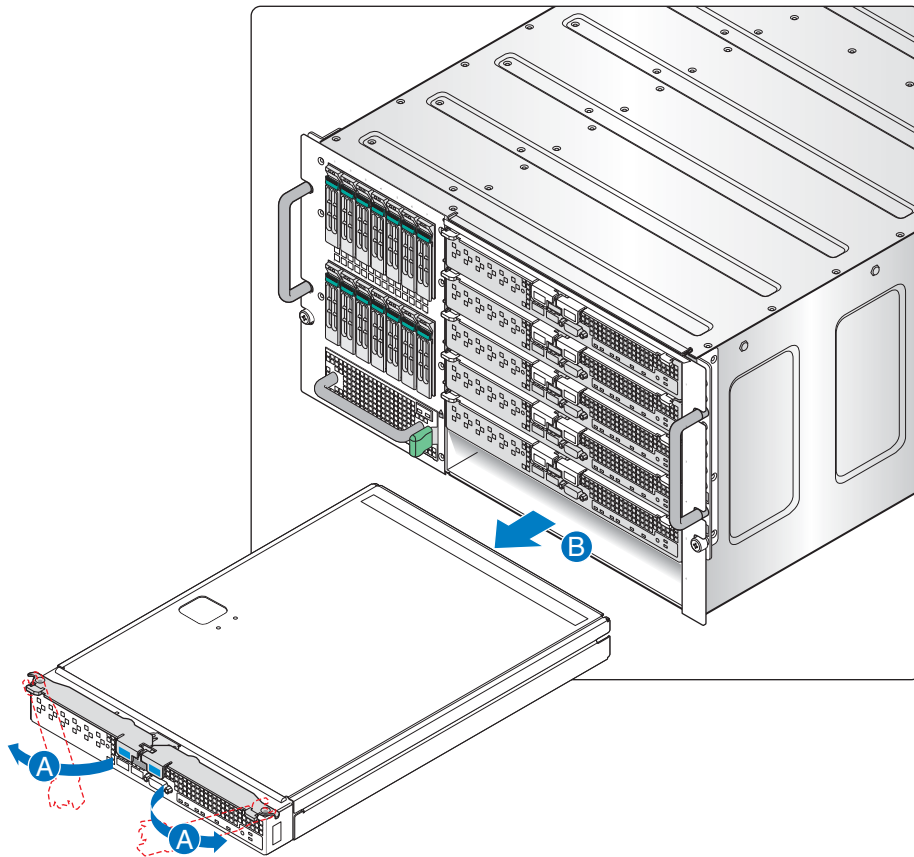

AF002432

Figure 32. Removing an Intel® Compute Module

4. Place either a filler or another compute module in the bay within two minutes. This step is required to maintain proper airflow throughout the server system and to ensure proper system cooling.

3 Using the Modular Server System

Minimum Hardware Requirements

To successfully power up the Intel® Modular Server System MFSYS25V2 and to avoid integration difficulties and possible system damage, your modular server system must meet the minimum hardware requirements listed in the following table.

Table 4. Hardware Requirements

| Component | Quantity | Location |
|------------------------|----------|--|
| Ethernet switch module | 1 | Slot labeled SWM1 |
| Storage control module | 1 | Slot labeled SCM1 |
| Management module | 1 | Slot labeled CMM |
| Power supply module | 1* | Power supply module bay 1 |
| Power supply blank | 3 | Power supply module bays 2, 3 and 4 |
| I/O cooling module | 1 | I/O cooling module bay |
| Main cooling module | 2 | Main cooling module bays 1 and 2 |
| Intel® Compute Module | 1 | Compute module slot 1 |
| Compute module blanks | 5 | Compute module slots 2, 3, 4, 5, and 6 |

Note: * Base MFSYS25V2 configurations include two power supply modules and two blank power supply fan modules

Starting Up Server System

The Intel® Modular Server System MFSYS25V2 does not have a power switch. When the chassis has at least one power supply with power cord plugged into an appropriate electrical outlet, standby power is available. With standby current, a user can remotely connect to the management module and/or power on a compute module. Each compute module has a front panel power switch. Refer to the appropriate compute module *Technical Product Specification* and *User Guide*.

Installing an Operating System

Before installing an operating system, you must first configure storage and networking via the management module's graphical user interface (GUI).

One possible way to install an operating system is as follows:

1. Connect a remote client machine to the management module in the Intel[®] Modular Server System MFSYS25V2 via a cross-over cable.
2. Connect a USB hub to one of the USB ports to allow more than two USB devices to be used.
3. Connect a video monitor and USB mouse and keyboard to the front of the compute module using the USB hub.
4. Connect a USB CD-ROM/DVD-ROM drive to the compute module.
5. From the remote client machine, log into the management module and configure storage and (optionally) networking for the compute module.
6. Power on the CD-ROM/DVDROM drive and insert the operating system install media.
7. Power on the compute module and install the operating system.

For configuration details, see “Using the Intel[®] Modular Server Control User Interface” on page 47.

Monitoring the Server System

The management module reports complete system health. From a remote client, an IT administrator can easily monitor the state of the server system. For more details, see “Using the Intel[®] Modular Server Control User Interface” on page 47 .

Shutting Down the Server System

To remove power from the Intel[®] Modular Server System MFSYS25V2, you must first properly power down all compute modules. Next, disconnect all power cables from the power source. For more information on powering down the compute module(s), refer to the *Intel[®] Compute Module MFS5520VI User Guide*.

4 Using the Intel® Modular Server Control User Interface

This section provides an overview of the Intel® Modular Server Control for the Intel® Modular Server System MFSYS25V2. The Intel® Modular Server Control User Interface (UI) provides complete system hardware management by enabling users to securely configure and monitor the system. The system is intended to be managed over a secure, private management network. It is recommended that the Intel® Management Module not be connected to a publicly accessible network.

Full system management is only supported via the Intel® Modular Server Control. In addition to the Intel® Modular Server Control UI, administrators can access system-level information remotely via SNMP. For information regarding SNMP v2 and v3 support, refer to the installed *Unified Firmware Update (UFU) Release Notes*.

This section covers the Intel® Modular Server Control UI features and provides detailed instructions for configuring the modular server system.

Introduction

The Intel® Management Module provides a simple and intuitive browser-based graphical user interface that IT administrators can use to monitor and configure the Intel® Modular Server System MFSYS25V2. This GUI is referred to as the Intel® Modular Server Control UI. No CDs or additional installation steps are required to use the UI. To initially launch the UI and configure the system hardware, a default static IP address and user account are provided. After logging into the UI, IT administrators can:

- Quickly access system and component information.
- Configure and manage storage subsystems, including but not limited to:
 - Create, delete and/or rename a storage pool
 - Create, delete, rename and/or reassign a virtual drive to a compute module
 - Create or delete hot spares
- Configure and manage switch modules, including but not limited to:
 - Assign internal and external ports to a virtual LAN (VLAN)
 - Configure external port settings
 - Launch an Advanced Configuration for additional switch configuration features
- Quickly view hardware inventory, system event logs, storage allocation and system configuration reports.
- Easily view current status for all hardware components (servers, hard drives, switch modules, storage control modules, management module, cooling modules, and power modules).

- Configure common settings, such as:
 - View and modify the IP address assigned to the management module.
 - Configure alert notification destinations and policies
 - Manage Intel[®] Modular Server Control user accounts
 - Update system firmware

System Configuration Requirements

This section provides an overview of the modular server system configuration requirements. Specifically, you must complete each of the following requirements:

- Update System Firmware (recommended):

Prior to configuring the modular server system, it is recommended that you update the system firmware to the latest release. For more information regarding the firmware update process, see [“Steps to Update the System Firmware” on page 159](#).
- Install physical hard drives (required):

Physical hard drives must be present in the modular server system before you can configure the modular server system storage.
- Configure Storage (required):

Configuring storage includes grouping installed physical hard drives into storage pools, creating virtual drives, and assigning the virtual drives to one or more compute modules. Storage configuration also includes creating and assigning hot spares to storage pools. For more information, see [“Storage Configuration” on page 63](#).
- Install at least one Intel[®] Compute Module MFS5520VI (required):

When configuring storage, a compute module does not need to be present in the system. Virtual drives can be assigned to a compute module slot/bay in the chassis regardless of whether or not a compute module is present. However, in order to install an operating system, you must first insert a compute module into the Intel[®] Modular Server System MFSYS25V2.
- Modify the Intel[®] Modular Server Control UI Administrator account password (recommended):

For security reasons, it is recommended that you change the default administrator password once the system is configured. For more information, see [“User Accounts” on page 142](#).
- Modify the external IP address for the Intel[®] Management Module (required):

This is the IP Address used to access the Intel[®] Modular Server Control UI. Before installing the modular server system on a network, change the external IP address and hostname as needed. You will need to change the management module default static IP address if more than one Intel[®] Modular Server System MFSYS25V2 is present on the network, or if the default management module IP address cannot be accessed in the installed network environment. For more information, see [“IP Configuration” on page 133](#).
- View modular server system health and additional required actions (recommended):

To ensure the modular server system is functioning properly, it is recommended that you review the current health status for installed components and verify all required actions are completed. The Dashboard provides an easy-to-use interface to quickly view all required actions, health status for all installed components, and information on all recent critical events. From the Dashboard, you can select any required action, component, or event to get detailed information. For more information, see “Dashboard” on page 126.

Setting Up a Remote Connection

The modular server system is intended to be managed over a secure, private management network. It is recommended that the Intel[®] Management Module not be connected to a publicly accessible network.

The two recommended options for connecting a client system to the Intel[®] Management Module in order to launch the Intel[®] Modular Server Control UI are illustrated below. Before connecting the remote system, ensure all hardware components (servers, hard drives, switch modules, storage control modules, the management module, cooling modules, and power modules) are installed in the Intel[®] Modular Server System.

Option 1: Connect the client system and the Intel[®] Management Module to an external switch using two Ethernet cables, as illustrated in the following image.

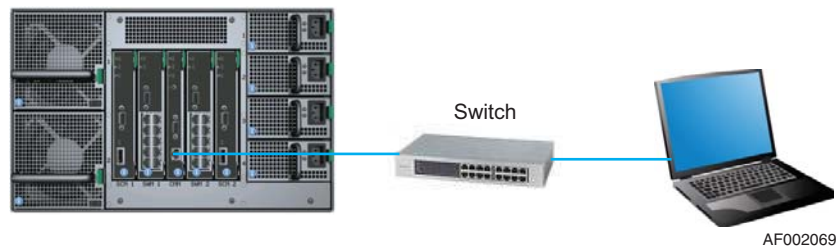

Figure 33. Connection using a switch

Option 2: Connect the client system directly to the Intel[®] Management Module using a cross-over cable, as illustrated in the following image.

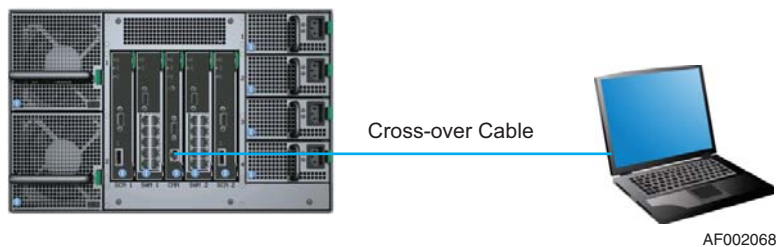

Figure 34. Connection using a cross-over cable

Remote Client System Requirements

This section describes the minimum system requirements for a client computer that is accessing the Intel[®] Modular Server Control user interface through a web browser.

Table 5. Minimum System Requirements for Remote Web Console

| Requirement | Remote Web Consoles/Clients |
|----------------------|---|
| Operating System | Any operating system that supports either the Microsoft Internet Explorer* or Mozilla Firefox* web browser. |
| Web Browser | Microsoft Internet Explorer* 7 or 8 Mozilla Firefox* version 3.x or later NOTE: For more information on web browser support and feature functionality, refer to the Release Notes. |
| Browser Plug-ins | Adobe* Flash Player Version 9 plug-in or later Java* SE Runtime Environment 6 Update 1 or later |
| TCP/IP Network Stack | Yes |

Download Browser Plug-ins

Download the latest required Microsoft Internet Explorer* and Mozilla* Firefox plug-ins at:

- Adobe* Flash Player: <http://www.adobe.com/products/flashplayer/>
- Java* SE Runtime Environment 6, Update 1: <http://www.java.sun.com/javase/downloads/index.jsp>

Log in to the Intel[®] Modular Server Control

To launch the Intel[®] Modular Server Control, open a browser session on the remote client system.

Enter the Intel[®] Management Module default static IP address of 192.168.150.150 in the address bar of the web browser. The login screen (see [Figure 35](#)) is displayed.

An administrator user account is enabled for the system. This default administrator account provides access to all available management configuration settings and actions.

User Account information:

- Username: admin
- Password: admin

Note: Username and password are case sensitive.

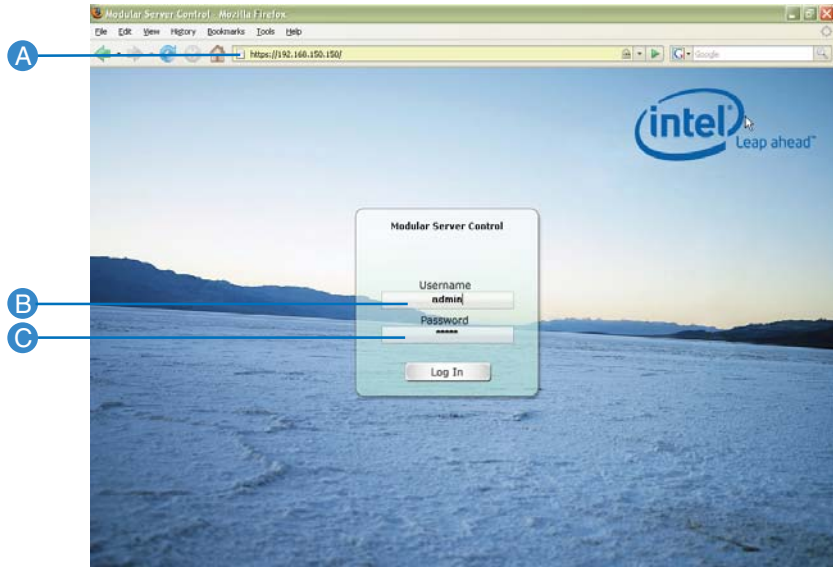

AF002066

| | |
|---|---|
| A | Enter Management Module IP Address, 192.168.150.150 |
| B | Enter Default Username (<i>admin</i>) |
| C | Enter Default Password (<i>admin</i>) |

Figure 35. Intel® Modular Server Control Login

Layout and Key Navigation Features

The Intel® Modular Server Control interface simplifies system configuration and management through use of navigation and common layouts. The general screen layout consists of the following:

- **Top Menu:** This menu provides tabs for quick access to multiple system views. For more information regarding the top menu tabs, see [Table 6](#).
- **Left navigation panel:** This panel provides access to system configuration screens, reports, and general setting configuration screens. For more information regarding the menus in the left navigation panel, see [Table 6](#).
- **Main body:** This section provides the content for the selected view or screen. The system configuration screens are designed to present all available information and actions for a selected system component in the main body of the interface.

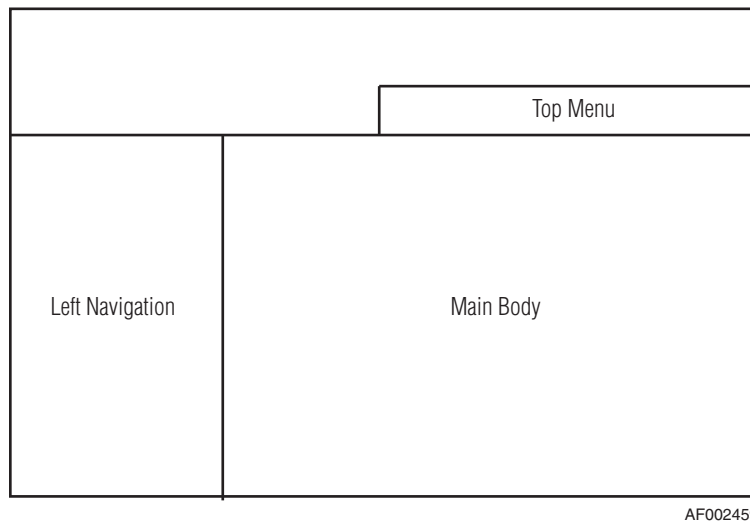

Figure 36. Intel® Modular Server Control General Layout











Figure 37 illustrates the layout and types of information presented on the system configuration screens.





Figure 37. Intel® Modular Server Control Configuration Screen Layout

Table 6. Intel® Modular Server Control Configuration Screen Layout

| | Item | Description |
|-----------------------------|-----------------------|--|
| General Navigation | | |
| A | Current User | Displays username for the currently logged in user. |
| B | Logoff | Ends current session and returns to Login screen. |
| C | Help | Intel® Modular Server Control UI Help |
| D | Top Menu Tabs | <p>Quickly switches between key sections of the Intel® Modular Server Control. In particular, the following tabs are provided:</p> <ul style="list-style-type: none"> • Dashboard: This tab is displayed by default after logging into the Intel® Modular Server Control UI. It provides a snapshot view of the overall system and component health, and also lists all the required actions and critical events. This screen can also be accessed from the left navigation panel by clicking Reports > Dashboard. For more information, see “Dashboard” on page 126. • Chassis Front: This tab provides an accurate visual view of the front of the chassis, which can be used to view the current health and determine the availability of each component. For more information, see “Chassis Front” on page 56. • Chassis Back: This tab provides an accurate visual view of the back of the chassis, which can be used to view the current health and determine the availability of each rear component. For more information, see “Intel® Gigabit Ethernet Switch Module 1 and 2” on page 84. • Storage: This tab provides access to the Storage Configuration screen, which can be used to quickly group drives, create and assign virtual drives to servers, assign hot-spare drives, and also view system health, status, and product details. This screen can also be accessed from the left navigation panel by clicking System > Storage. For more information, see “Storage Configuration” on page 63. • Virtual Machines: This tab provides access to the virtualization features of the Modular Server, which are used to build Virtual Machines. This screen can also be accessed from the left navigation panel by clicking System > Virtual Machines. For more information, see “Virtual Machines” on page 92 • Events: This tab provides access to the Events screen, which can be used to quickly view and acknowledge new events for all system components in a single location. This screen can also be accessed from the left navigation panel by clicking Reports > Events. For more information, see “Events” on page 124. |
| E | Left Navigation Panel | <p>The left navigation panel contains links to the following main menus:</p> <ul style="list-style-type: none"> • System: This menu provides direct links to configure and manage individual hardware components. For detailed information on the System menu and the submenus available under the System menu, see “System” on page 57. • Reports: This menu provides access to various reports. For detailed information on the Reports menu and the submenus available under the Reports menu, see “Reports” on page 121 • Settings: This menu provides access to general configuration settings. For detailed information on the Settings menu and the submenus available under the Settings menu, see “Settings” on page 131. |
| F | Main Body | Displays content for the selected menu item or view. For the system items, the main body is divided into four panes: the system graphic, action menu, context-sensitive help, and informational tabs. |
| System Screen Layout | | |

| | Item | Description |
|---|--|--|
| G | System Graphic | Interactive visual representation of the current state of the system hardware. By selecting a system component from the chassis graphic, the content changes in the main body to display all available actions and information for the selected component. |
| H | Change Chassis View | Switches between the front and back views of the system chassis. |
| | view front  | Switches the chassis view from back to front. |
| | view back  | Switches the chassis view from front to back. |
| I | Action Menu | Displays all available actions for the selected chassis component. |
| J | Context-Sensitive Help | Quick tips and links to context-sensitive help for the selected component. |
| K | Informational Tabs | Displays detailed information, including, but not limited to, current status, configuration and events for the selected component. |
| Component Health and State Icons | | |
| L |  | Information Icon – hover over icon to view component summary information. |
| M |  | Health Icon - health OK |
| N |  | Health Icon – warning; hover over icon to view component summary information. |
| O |  | Health Icon – critical; hover over icon to view component summary information. |
| P |  | Storage Pool - indicates drive is included in an existing storage pool. |
| Q |  | Dedicated Hot Spare Icon - indicates hard drives that have been designated as designated hot spares to specific storage pools. Hover over icon to view component summary information. |
| R |  | Global Hot Spare Icon – indicates hard drives that have been designated as global hot spares. Hover over icon to view component summary information. |
| S |  | Server is powered off. |

| | Item | Description |
|--|---|--|
| |  | Ready for Transport |
| |  | Transitioning – Indicates either a firmware update or other background activity is in progress |

Chassis Front

The Chassis Front view provides an accurate visual view of the front of the chassis, which includes all compute modules, hard drives and the I/O fan. This real-time view enables an IT administrator to select the component of interest, quickly view the current health, and also determine which components are present or not present. The icons present on each component indicate the current health and provide additional information regarding power state and role. By hovering over the component icon, a brief summary of the current health, state and component description is displayed in a pop-up box.

To access the Chassis Front view, click the Chassis Front tab in the top menu. By default, no components are selected on the chassis in this view.

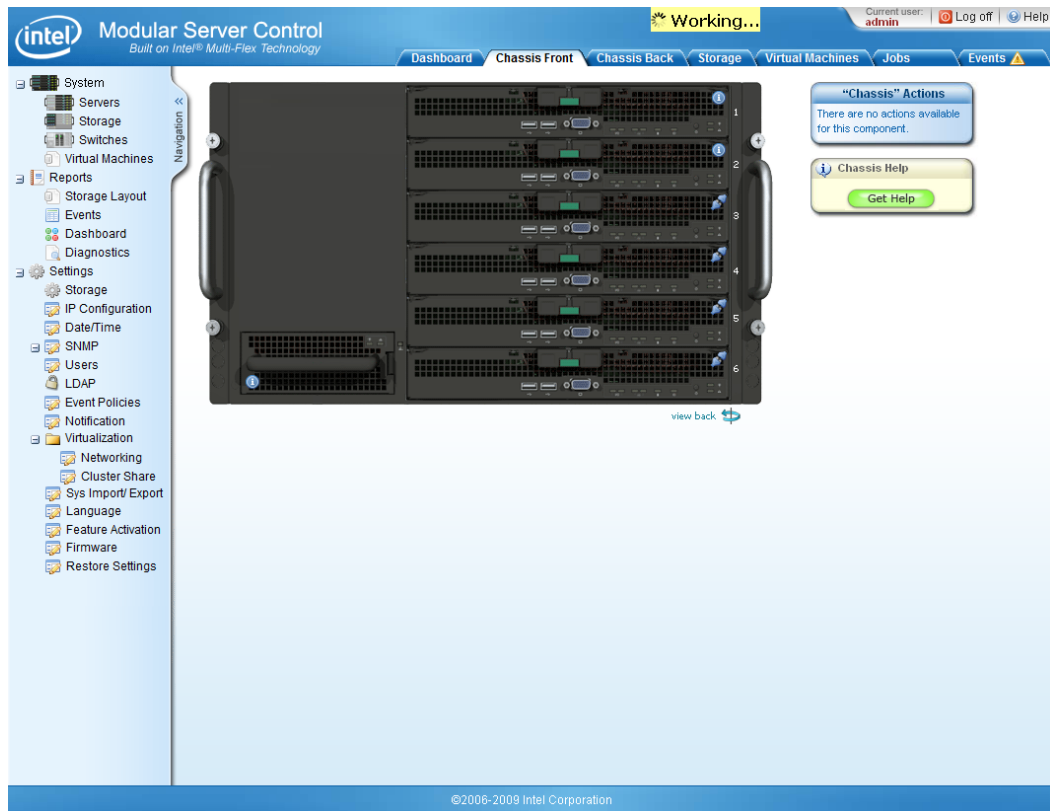

Figure 38. Chassis Front View

System

The System menu in the left navigation panel enables IT administrators to quickly configure and view the most commonly accessed components (compute modules, storage control modules, and switch modules). When a system component is selected, the content in the action box, help box and informational tabs change to reflect the current actions and information for the selected component.

Intel® Compute Module View

The Intel® Modular Server System MFSYS25V2 supports up to six Intel® Compute Modules. To maintain the proper cooling within the modular server system, all empty bays must be populated with the appropriate filler panels.

The Intel® Modular Server Control UI enables an IT administrator to remotely power-cycle compute modules, launch a remote KVM (keyboard, video and mouse) session, and view health information and product details. To view the current status, available actions, and product details for an installed Intel® Compute Module, either click System > Servers in the left navigation panel or click the Chassis Front tab in the top menu to display the front of the system and select the specific compute module from the system graphic. The content displayed on the informational tabs, action box, and help box will be updated with product-specific information and actions available for the selected compute module highlighted in green. The current health and product summary information is quickly available by moving the mouse over the Health/Information icon located on the selected compute module.

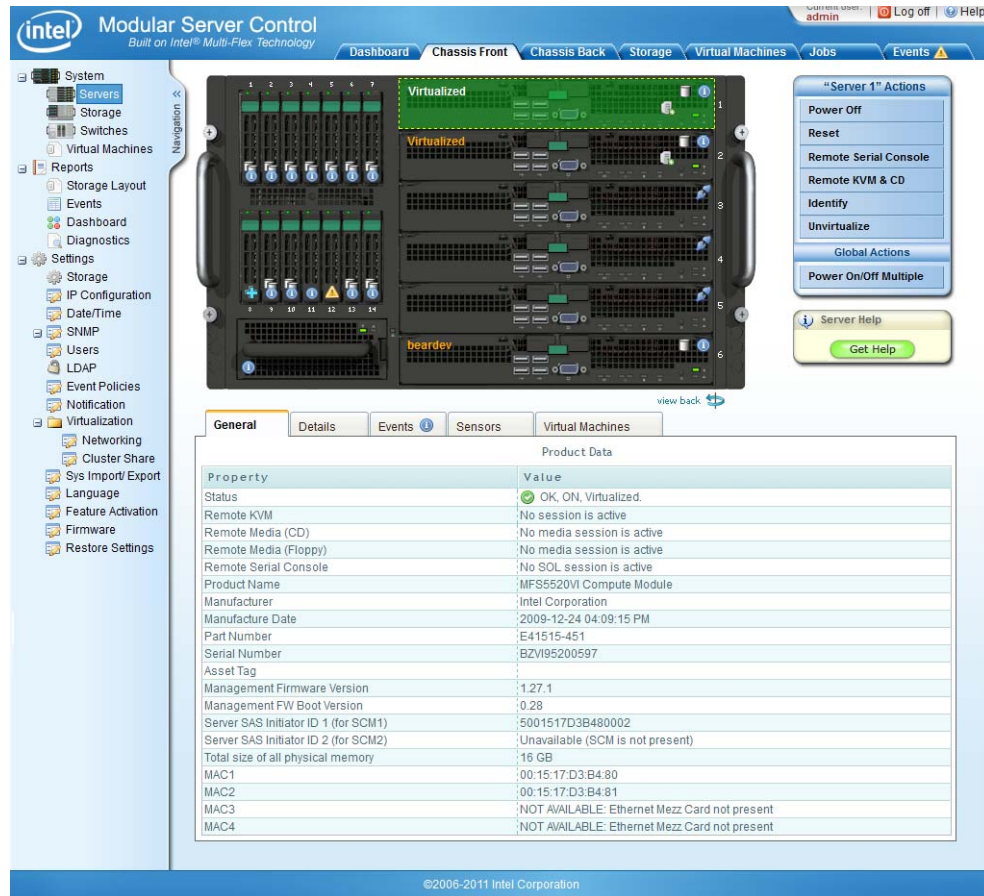







Figure 39. Intel® Compute Module View

The following information and actions are available for a selected server.

Health Icons

The health icons are displayed on the graphical representation of the component when the component is selected.

Table 7. Health Icons

| Health Icon | Meaning |
|--|---|
|  | Critical (For details, see the Event Log. For information about accessing the Event Log, see “Events” on page 124.) |
|  | Warning (For details, see the Event Log. For information about accessing the Event Log, see “Events” on page 124.) |
|  | Information |
|  | OK |
|  | Powered Off |
|  | Firmware update or other background activity |

Intel® Compute Module Actions

The actions available for a selected server are displayed to the right of the system graphic. For a description of these actions, refer to the following table.

Table 8. Server Action Menu

| Action Menu Item | Description |
|-------------------|--|
| Power On (if Off) | Allows the user to remotely power on the selected server. |
| Power Off (if On) | <p>Allows the user to remotely power off the selected server. The following two options are presented in a pop-up menu when Power Off is selected:</p> <ul style="list-style-type: none"> • Graceful: Ends the current operating system session on the selected server before powering off the server. • Forced: Bypasses the shutdown of the operating system and immediately powers down the server. <p>CAUTION: A “Forced” Power Off could result in a loss of data and/or damage to the server. It is highly recommended to use the “Graceful” option under normal circumstances.</p> |

Table 8. Server Action Menu

| Action Menu Item | Description |
|-------------------------------|--|
| Reset | <p>Allows the user to remotely reset the selected server. This action has the same effect as pressing the front panel reset button.</p> <p>CAUTION: This may cause data loss on the server. Use the Graceful Shutdown to shut down applications and the operating system.</p> |
| Remote Serial Console | <p>Opens a new window that includes instructions on how to connect to the server's remote serial port using a secure shell (SSH) client application. The serial port, if enabled in BIOS enables you to view server startup messages, enter the BIOS Setup (use <Escape>+2 key sequence), view OS initialization messages and interact with an application or OS that makes use of the serial port.</p> |
| Remote KVM & CD | <p>Opens a new window, allowing an IT administrator to use remote keyboard, video, and mouse (KVM) and media to monitor and manage the selected server remotely. The KVM functionality allows you to view server startup messages, enter the BIOS setup, and interact with the server operating system. The remote CD capability allows you to share a CD drive or CD image on your client machine with the remote server.</p> |
| Terminate KVM Session | <p>Sends a message to the KVM session user and terminates the KVM session.</p> |
| Identify | <p>Illuminates the server ID LED, which enables easy onsite identification of a selected server.</p> |
| Virtualize | <p>Prepares the server to host virtual machines. Once virtualized, the server module will be able to create virtual machine storage pools of server resources, and virtual machines within these pools.</p> |
| Unvirtualize | <p>Removes the ability of the server to host virtual machines, and returns the server module to its original operational state. The user has the option of deleting the created virtual machine storage, or retaining it for later use.</p> |
| Server Failover | <p>Rapidly reassigns all virtual drives from the currently assigned server slot to another server slot. As an example, this may be required when a server encounters hardware problems.</p> <p>Note: All drive positions are preserved during this operation.</p> |
| Global Action Menu Item | Description |
| Power On/Off Multiple Servers | <p>Enables an IT administrator to power on or off multiple servers at once. Select the type of action first (power on, power off, reset). Then select the servers to apply the action.</p> <p>CAUTION: To avoid potential data loss when selecting power off the Graceful Shutdown option is recommended to shut down applications and the operating system.</p> |

Intel® Compute Module Details

The tabs displayed below the system graphic provide detailed information on the selected server. For a description of these tabs, refer to the following table.

Table 9. Server Tabs

| Tab Heading | Description |
|------------------|---|
| General | The General tab displays: <ul style="list-style-type: none">• Current status of the selected server (i.e., health, power state, etc.)• Product data information (i.e., manufacturer, model number, serial number, firmware versions, etc.) |
| Details | Displays all the current CPU and memory information the selected server. |
| Events | Displays all system events for the selected server. |
| Sensors | Displays current sensor information. |
| Virtual Machines | Displays the status of the virtual machines on a virtualized compute module. |
| Virtual Drives | Displays a detailed table of all virtual drives assigned to the selected server. The table provides the following details: Name, Size, RAID Level, Status, Drive Number and Assigned Server. |
| Mezzanine | Displays the status of the mezzanine card installed in the compute module. |

Intel® Compute Module Help

To quickly access additional help regarding the Intel® Compute Module screen, actions, and tabs, click the Get Help button in the Server help box located under Actions.

Remote KVM & CD

The Remote KVM & CD feature can be used to connect a remote text-based or graphical console to any of the compute modules. This feature supports remote keyboard, video, mouse, and CD drive. This may be used, for example, to load an operating system.

Steps to Launch the Remote KVM Console

1. Click System > Servers in the left navigation panel.
2. Select the target compute module server.
A compute module must be present in the system to start a remote KVM & CD session.
3. If the server is off, click Power On on the Actions menu and click Apply to confirm the action.
4. Click Remote KVM & CD to start a KVM Remote Console.
5. In the dialog box that appears, complete the following:
 - a. Select Video display color resolution: High resolution for 65,536 colors, or Low resolution for 125 colors. Choose the lower color depth if you are experiencing network or performance problems on the client computer.

- b. Select Mouse Mode. Choose Absolute if the remote server is running the Microsoft Windows* operating system. Choose Relative if the remote server is running the Linux* operating system.
 - c. If you selected the Relative Mouse Mode, enter the Mouse Acceleration and Threshold values. These values must match the settings on your remote server.
 - d. Select the Keyboard Type to use: the US/English layout, or German layout.
 - e. Click Apply to start a Remote Keyboard, Video, Mouse (KVM) with CD redirection on the target server.
6. Accept all the dialog boxes that appear to open the KVM session in a new window. A blank KVM window is displayed.

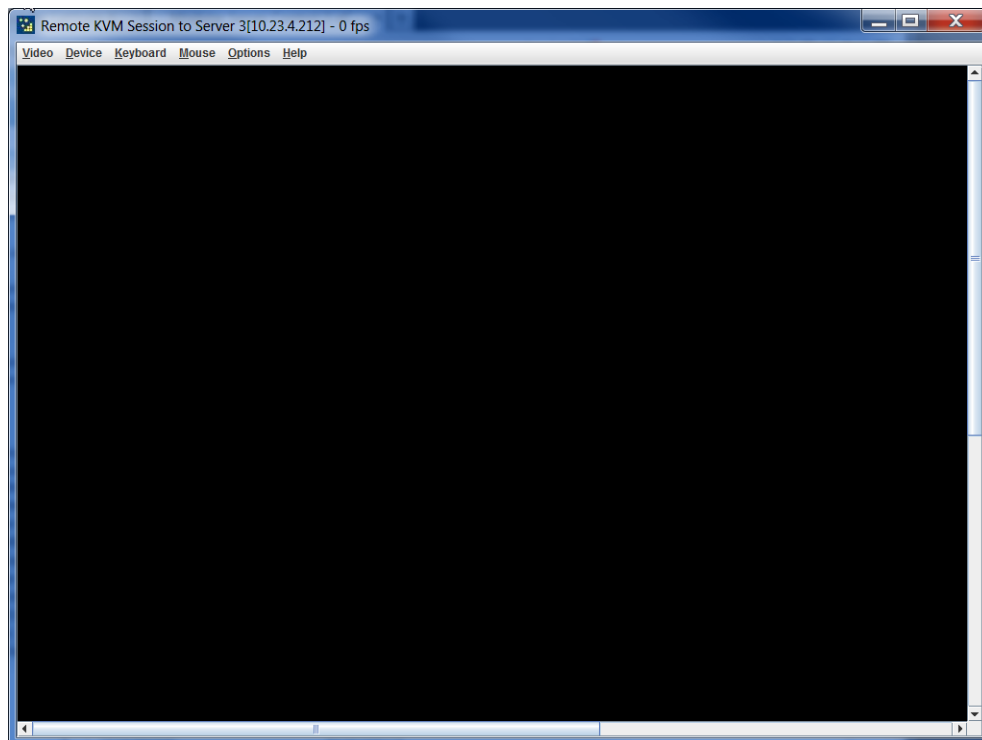

Figure 40. Server Action - Remote KVM & CD

7. Select Start Redirection from the Redirection menu.
If the option is grayed out, then the session has been automatically started.
8. To install an application from a CD, insert the CD into the remote console's CD-ROM drive and select CD from the Devices menu.

Storage Configuration

The Intel® Modular Server System MFSYS25V2 supports up to 14 2.5-inch SAS drives. These drives are shared between all compute modules. The physical disk drives are not directly connected to the compute modules. To assign storage to a compute module, a storage pool must be created first. Once a storage pool is created, a virtual drive can be created and assigned to one or more compute modules. This process is referred to as storage configuration. The Intel® Modular Server Control UI is used to configure storage for the Intel® Modular Server System MFSYS25V2. Storage configuration involves the creation and management of storage pools, virtual drives, and hot spares. This includes assigning virtual drives to one or more compute modules.

This section provides information on creating an initial storage pool, creating an initial virtual drive and mapping the virtual drive to a compute module using the Intel® Modular Server Control UI. Once a virtual drive is mapped to a compute module, an operating system can be installed.

To access the storage configuration screen, either click the top menu Storage tab or click System > Storage in the left navigation panel.

Creating a Storage Pool

The initial storage configuration step is to create a storage pool or grouping of physical disk drives. Once a storage pool is created, virtual drives can be created within the storage pool and assigned to a compute module.

Steps to create a storage pool

1. To configure storage, click the top menu Storage tab or click System > Storage in the left navigation panel.

When the storage configuration screen is displayed for the first time, no storage pools or virtual drives are present. The storage screen looks similar to the following image.

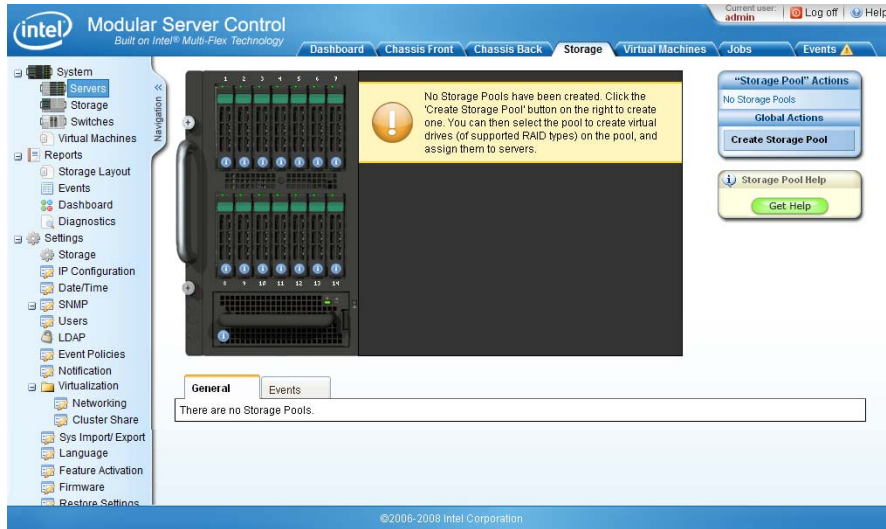

Figure 41. Initial Storage Configuration Screen

2. To assign one or more drives to a storage pool, click Create Storage Pool on the Storage Pool Actions menu.

The following dialog box appears.

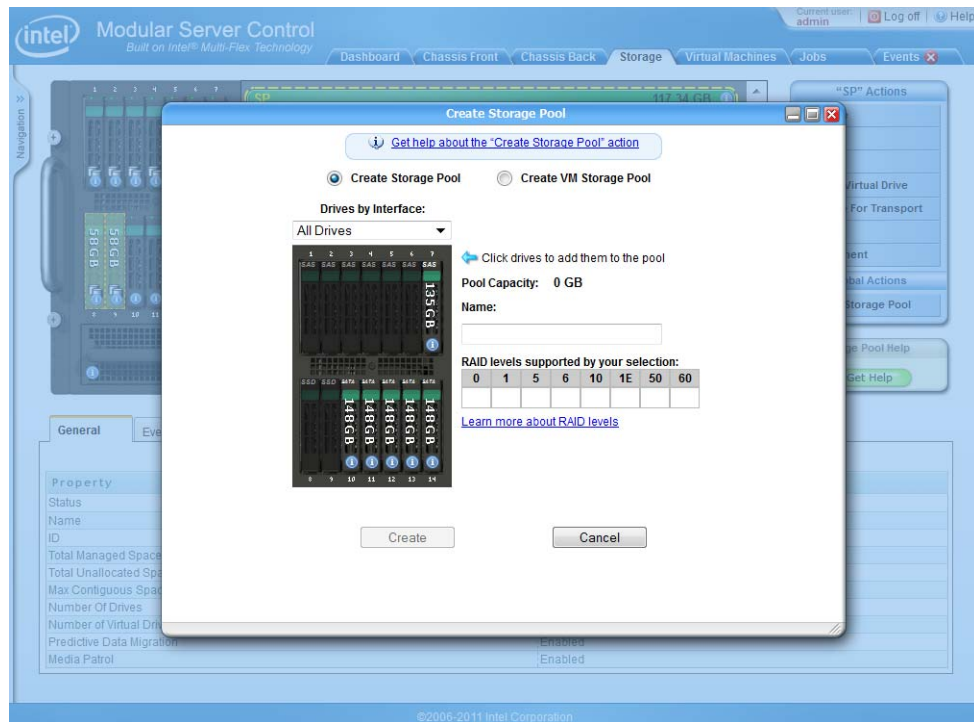

Figure 42. Create Storage Pool Dialog Box

3. Select the type of storage pool to create. If the pool is to be used with compute modules, select Create Storage Pool. If the pool is to be used with virtual machines, select Create VM Storage Pool.

Note: A VM Storage Pool is created during the first time the virtualization action is used. The current action is used to create additional storage pools for VMs.

4. Enter a name or label for the storage pool.
5. Select the physical hard drives that are to be grouped together to create a single storage pool.

If a hard drive is available, the drive size is displayed. Selected drives are highlighted in green with the drive size displayed on each of the drives. Hard drives that are either included in an existing storage pool or configured as a hot-spare drive cannot be selected on this screen and are considered unavailable. Unavailable drives are displayed as darker than the available hard drives and do not have the drive size displayed on the image. The highlighted drive carriers identify the physical hard drives that have been selected for the storage pool. In this example (see [Figure 43](#)), drives 10, 11, 12, and 13 are selected.

6. Verify that the overall storage pool capacity and available RAID level options supported by the number of physical drives selected meets your storage requirements.

The Pool Capacity displays the total available storage space for the new storage pool. In [Figure 43](#), four 148 GB hard drives are selected to be grouped together to create a single storage pool with a Pool Capacity of 592 GB.

The RAID level options are determined based on the number of hard drives selected for the storage pool. In [Figure 43](#), four hard drives are selected. The RAID levels supported by grouping hard drives 10, 11, 12, and 13 together as a single storage pool are: 0, 5, 6, 10, and 1E. It is important to note that the RAID level is not assigned to a storage pool. Instead, it is assigned to the virtual drives within a storage pool. This enables a single storage pool to support many virtual drives with different RAID levels.

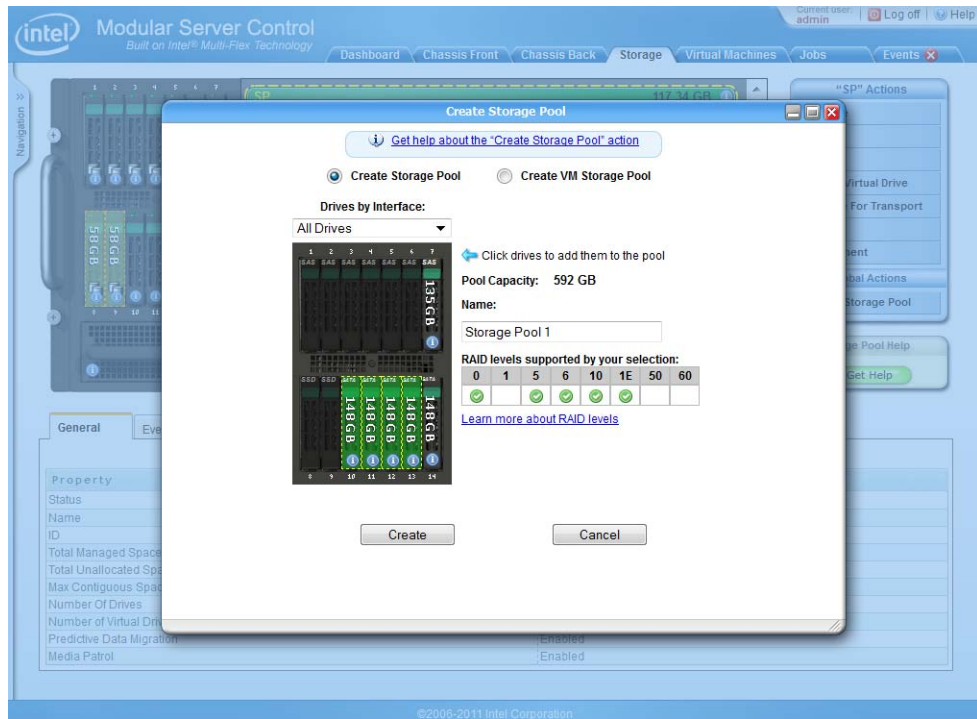

Figure 43. Create Storage Pool Dialog Box Example

7. Click Create to create the new storage pool.

Once a storage pool has been created, the Storage screen changes to highlight the newly created storage pool. The action box, help box, and informational tabs update to provide all available actions and information for the selected storage pool. Current health and product summary is quickly available by moving the mouse over the Health/Information icon located on the selected storage pool.

The following image displays information for the storage pool.

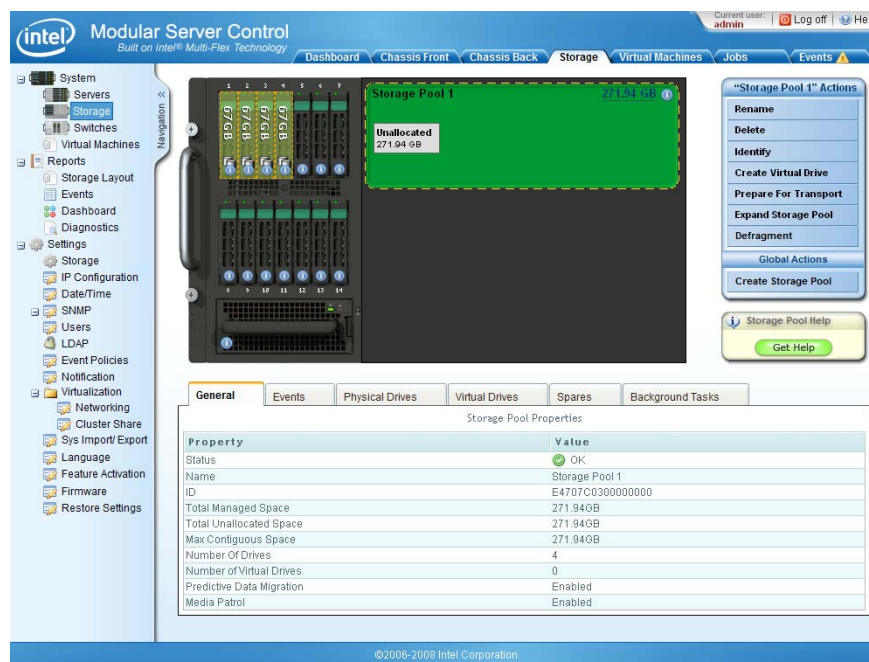

Figure 44. Storage Pool Screen

Health Icons

The health icons are displayed on the graphical representation of the component when the component is selected.

Table 10. Health Icons

| Health Icon | Meaning |
|-------------|---|
| | Critical (For details, see the Event Log. For information about accessing the Event Log, see "Events" on page 124.) |
| | Warning (For details, see the Event Log. For information about accessing the Event Log, see "Events" on page 124.) |
| | Information |
| | OK |

You may see one of the following health status descriptions as you move the mouse cursor over the storage pool icon or the status health icon on the General Tab:

- **Incomplete:** The Storage Pool is missing one or more physical disk drives. This can occur if the drives in a Storage Pool are transported to another system, but not all the drives are inserted. You can insert the missing drives, or choose to accept the incomplete status when prompted.
- **Media Patrol Running:** The storage pool is operational and the media patrol background task is running (this is a background task that looks for defects).
- **Rebuilding:** The storage pool is rebuilding as a background task.
- **Migrating:** The storage pool has a background task that is expanding the storage pool or one of the virtual drives.
- **Transitioning:** The storage pool is running a background task that is rebuilding the storage pool to another drive using a hot spare.
- **Predictive Data Migration Running:** An error detection background task is running.
- **Degraded:** One or more physical disk drives in the storage pool are offline and the storage pool is operating in a degraded mode.
- **Offline:** All the physical disk drives are offline.
- **Transport Ready:** All the physical disk drives are prepared for transport and can now be removed from the system.

Storage Pool Actions

The Storage Pool Actions displayed to the right of the system graphic enable an IT administrator to modify existing storage pools, remotely identify drives contained in a storage pool and create virtual drives. For a complete list of actions, refer to the following table.

Table 11. Storage Pool Actions Menu

| Global Action Menu Item | Description |
|---------------------------------------|---|
| Create Storage Pool | Designates one or more drives as a storage pool. Global storage actions are available at all times on the storage screen. |
| Storage Pool Action Menu Items | Description |
| Rename | Renames an existing storage pool. A dialog box will be displayed prompting the user for the new storage pool name. |
| Delete | Deletes an existing storage pool. This action will delete all virtual drives contained in the selected storage pool and release the drives for future storage pool configuration. ALL DATA WILL BE LOST. |
| Identify | Illuminates the hard drive ID LED, which enables easy onsite identification of the drives included in the selected storage pool. |
| Create Virtual Drive | A virtual drive is assigned a name, RAID level, size and server. Once a virtual drive is created, an operating system can be installed. |

Table 11. Storage Pool Actions Menu

| Global Action Menu Item | Description |
|-------------------------|---|
| Expand | Allows the user to add one or more physical drives to an existing storage pool to increase available space. |
| Defragment | Starts background task to consolidate available memory in the Storage Pool. <i>Caution: This procedure may take a long time.</i> |
| Prepare for Transport | Prepares drives for removal from system. |
| Accept Incomplete State | Enables an IT administrator to accept a condition where the storage pool has fewer physical drives than it requires. The incomplete state occurs when some but not all physical drives belonging to a storage pool have been transported to a new system. NOTE: Virtual drives in an incomplete storage pool can be recovered by rebuilding the storage pool after you accept the incomplete state only if the RAID level of the virtual drive allows it to handle the loss of the number of drives that are missing from the storage pool. |
| Start Rebuild | This action is available if a physical drive in a storage pool has failed and needs to be recovered by rebuilding with the hot-spare drive. |

Storage Pool Details

The tabs displayed below the system graphic provide detailed information on the selected storage pool. For a description of these tabs, refer to the following table.

Table 12. Storage Pool Tabs

| Tab Heading | Description |
|------------------|---|
| General | The General tab displays: <ul style="list-style-type: none">• Current status of the storage pool (i.e., status, health, operation state)• Storage pool configuration data (i.e., storage pool ID, name, total managed space, total unallocated space, number of physical and virtual drives included in the selected storage pool) |
| Events | Displays all system events for the selected storage pool. |
| Physical Drives | Displays a table with detailed information on the physical drives included in the selected storage pool (i.e., Drive number, Manufacturer, Product ID, Serial Number, Firmware Revision, Size, Status). |
| Logical Volumes | This tab only appears on Storage Pools created for Virtual Machines, and displays information on the Logical Volumes in use by VMs. |
| Virtual Drives | Displays a table with detailed information on all virtual drives contained within the selected storage pool. The table provides the following details: Name, Size, RAID Level, Status, Drive Number, and Assigned Server. |
| Spares | Displays a table with detailed information on all hot-spare drives. The table includes the following information: Drive Number, Role (Global versus Dedicated), Manufacturer, Product ID, Serial Number, Firmware Revision, Size and Status. |
| Background Tasks | Displays status and state of current tasks, such as Predictive Data Migrations and Media Patrol. |

Storage Pool Help

To quickly access additional help regarding the storage pool screen, actions, and tabs, click on the Get Help button in the Storage Pool help box located under the actions.

Creating a Virtual Drive

Once a storage pool has been created, the next step is to create a virtual drive. Virtual drives are created in the storage pools and assigned to individual Server Compute Modules. The following are the key benefits of virtual drives:

- Virtual drives can be quickly reassigned to different servers with a couple of mouse clicks in the Intel[®] Modular Server Control UI without powering down the server or storage pool.
- Virtual drives in a single storage pool can be set to any RAID level that is supported by the selected storage pool.
- You can quickly and easily expand the size of a virtual drive to increase storage capacity.
- The assigned server's operating system will detect the virtual drive (and its associated drive position) during the boot process. Drive position 0 is the boot device. To the

operating system, the virtual drive will be indistinguishable from the local physical drive on the server (if installed).

- If the Intel[®] Shared LUN feature is activated and the operating system supports sharing LUNs, a virtual drive can be assigned to two or more servers.

The steps to create a virtual drive are as follows:

1. Select the existing storage pool, which will contain the virtual drive.
2. Select **Create Virtual Drive** from the storage pool action menu.

The following dialog box is displayed.

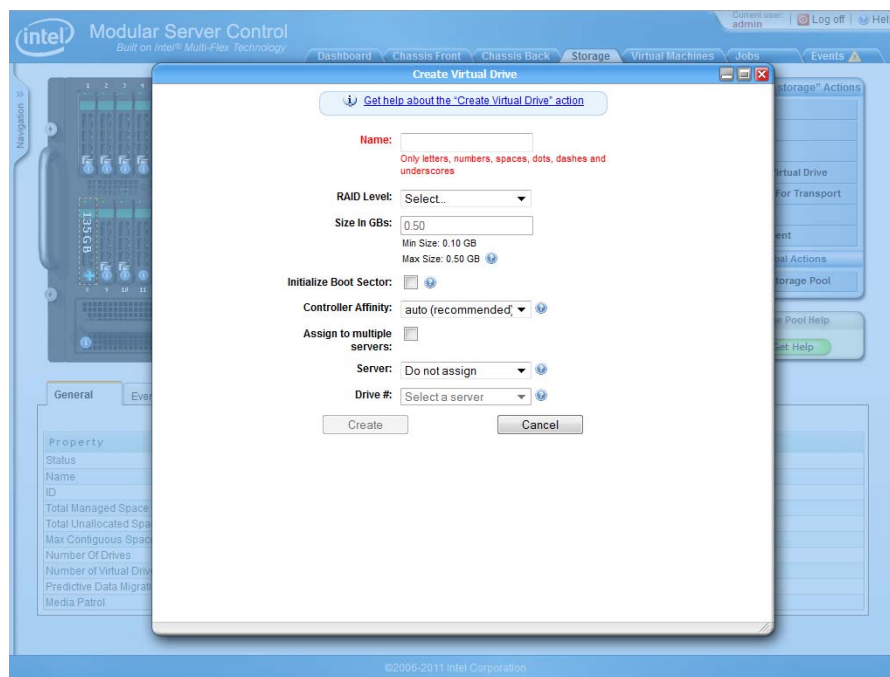

Figure 45. Create Virtual Drive Dialog Box

3. Enter a name for the virtual drive.
4. Select the RAID level for the virtual drive from the drop-down box.

The options available in the drop-down box are determined by the number of drives in the selected storage pool.

5. Enter the size for the virtual drive.

Depending on the RAID level selected, the maximum size displayed may change (i.e., if mirroring is selected).

6. Select the Initialize Boot Sector check box if an operating system will be installed on this virtual drive.

This will ensure a fresh volume for partitioning.

7. In the Controller Affinity list, select the preferred storage control module to handle requests for the virtual drive.

By default, this option is set to “auto (recommended)” but can be changed to either Intel® Storage Control Module 1 (SCM1) or Intel® Storage Control Module 2 (SCM2). By selecting “auto (recommended)”, the system assigns a storage control module for the virtual drive.

8. Assign or map the virtual drive to a server.

A virtual drive can be assigned to any of the six server slots. A server does not have to be present in the Intel® Modular Server System MFSYS25V2 for selection. This enables an IT administrator to assign virtual drives to servers that will be added to the system.

If the Intel® Shared LUN feature is activated, the “Assign to multiple servers” check box is displayed. When the check box is selected, the Intel® Shared LUN feature allows a virtual drive to be assigned to two or more servers. This feature requires operating system support for sharing LUNs.

9. Select the “Drive Position” for the virtual drive.

The drive position sets the drive number for this server. The drop-down box will show all available drive numbers (0 through 127).

10. Click Apply to create the virtual drive and return to the main Storage screen.

The virtual drive created will be displayed as a volume in the selected storage pool on the main storage screen. Depending on the RAID level selected, the virtual drive may continue to synchronize after it is created and displayed on the storage screen.

11. To view current status of the virtual drive, select the General, Virtual Drive or Background tasks tab to view more information about the virtual drive created.

Once a virtual drive is created and selected, the action menu and tabs change to display all available actions and details for the selected virtual drive. The following image shows the storage screen with a virtual drive selected.

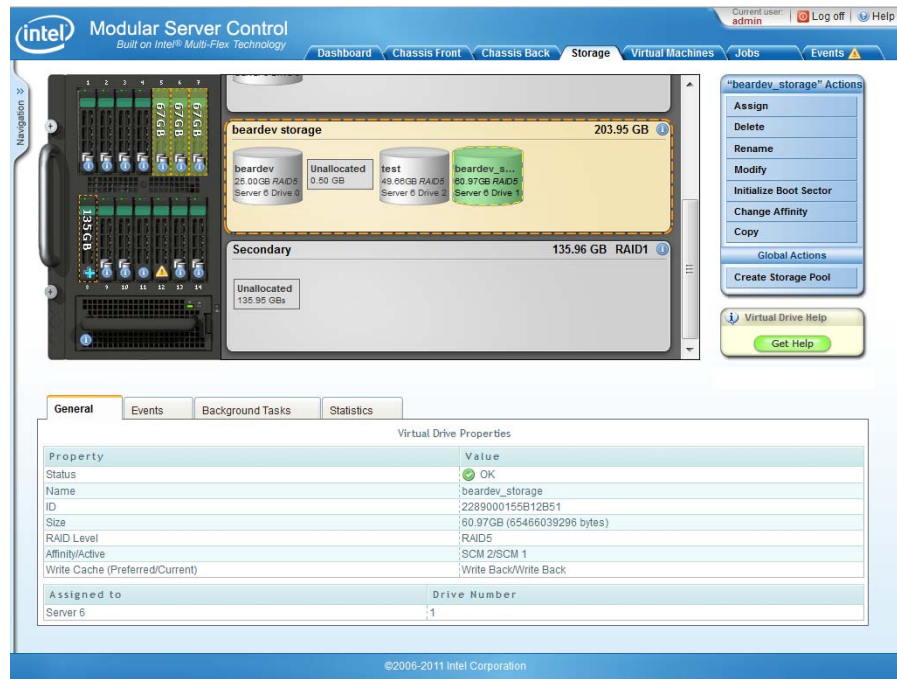







Figure 46. Virtual Drive Screen

Health Icons

The health icons are displayed on the graphical representation of the component when the component is selected.

Table 13. Health Icons

| Health Icon | Meaning |
|---|---|
|  | Critical (For details, see the Event Log. For information about accessing the Event Log, see “Events” on page 124.) |
|  | Warning (For details, see the Event Log. For information about accessing the Event Log, see “Events” on page 124.) |
|  | Information |
|  | OK |
|  | Activity (such as rebuild or data migration) |

You may see the following health status description as you move the mouse cursor over the health icon:

- **Degraded:** The virtual drive RAID array is available but has lost one or more disks. The virtual drive will be rebuilt automatically if a global or dedicated spare is available.

Virtual Drive Actions

The actions available for a selected virtual drive are displayed to the right of the system graphic. For a description of these actions, refer to the following table.

Table 14. Virtual Drive Action Menu

| Global Action Menu Item | Description |
|--|--|
| Create Storage Pool | Designates one or more drives as a storage pool. Global storage actions are available at all times on the storage screen. |
| Virtual Drive Action Menu Items | Description |
| Assign | Allows an IT administrator to: <ul style="list-style-type: none">• Assign an existing virtual drive to a different server• Change the current drive assignment for a server• Assign the virtual drive to no server. |
| Delete | Deletes an existing virtual drive. This action will delete the selected virtual drive. ALL DATA WILL BE LOST. |
| Rename | Renames an existing virtual name. A dialog box will display prompting the IT administrator for the new virtual drive name. |
| Expand | Expands the size of an existing virtual drive using any unallocated space within the storage pool in which the virtual drive resides. Note: This function is only available when the Intel® Modular Server Storage Management Pack feature is activated. |
| Initialize Boot Sector | Clears the first 64 MB of data that is used on boot disks for the Master Boot Record, which ensures that a fresh volume for partitioning is available for operating system installation. |
| Change Affinity | Changes the storage control module affinity for the selected virtual drive. The dialog box indicates which storage control module is currently assigned and provides the capability to change control modules. NOTE: Changing affinity will cause the selected virtual drive (LUN) to failover to the selected controller. If the virtual drive is in active use, there will be a slight pause in system I/O while the failover operation is handled by the multipath driver on the host operating system. |
| Copy | The Copy action will duplicate up to six copies of a virtual drive. This feature is a part of the Intel Modular Server Management Pack. |
| See Contents | The action only appears when the ISOSTORE is selected. It displays the files currently residing in the ISO Store folder. |

Virtual Drive Details

The tabs displayed below the system graphic provide detailed information on the selected virtual drive. For a description of these tabs, refer to the following table.

Table 15. Virtual Drive Tabs

| Tab Heading | Description |
|------------------|---|
| General | The General tab displays a table with the following information: <ul style="list-style-type: none">• Current status of the virtual drive (i.e., status, health, operation state)• Virtual drive configuration data (i.e., name, total space, RAID level, server assignment and drive number) |
| Events | Displays all system events for the selected virtual drive. |
| Background Tasks | Displays all active tasks. |

Virtual Drive Help

To quickly access additional help regarding the virtual drive actions and tabs, click on the Get Help button in the Virtual Drive help box located under the actions box.

Editing Virtual Drive Server Configuration

Once a virtual drive is created, an IT administrator can change the name, size, server assignment, and storage control module affinity at any time. This section describes the Assign action.

Use the assign action to change the current virtual drive server assignment. A virtual drive can be assigned to one or more servers and can be assigned any drive number that is available on the selected server. Each drive found by the operating system is given a number (drive position) based on the order found. The server does not need to be present to assign a drive because the system maintains the assignment based on server slot position.

When a compute module is replaced, the virtual drives assigned to the compute module bay are automatically assigned to the replacement compute module. This allows an IT administrator to quickly replace a compute module without changing the storage configuration or assigned resources, thereby resulting in no impact to stored data.

The virtual drive in drive position 0 is the only drive available for the boot device. For example, if you assign five virtual drives to a server and then enter the BIOS boot order setup menu for that server, you will only see one virtual drive listed there and that would be the virtual drive at drive position 0. However, after the operating system boots, all five virtual drives will be available for use.

To assign a virtual drive to a server, follow these steps:

1. From the Storage view, select a virtual drive.
2. Choose Assign from the action menu.

The following dialog box appears.

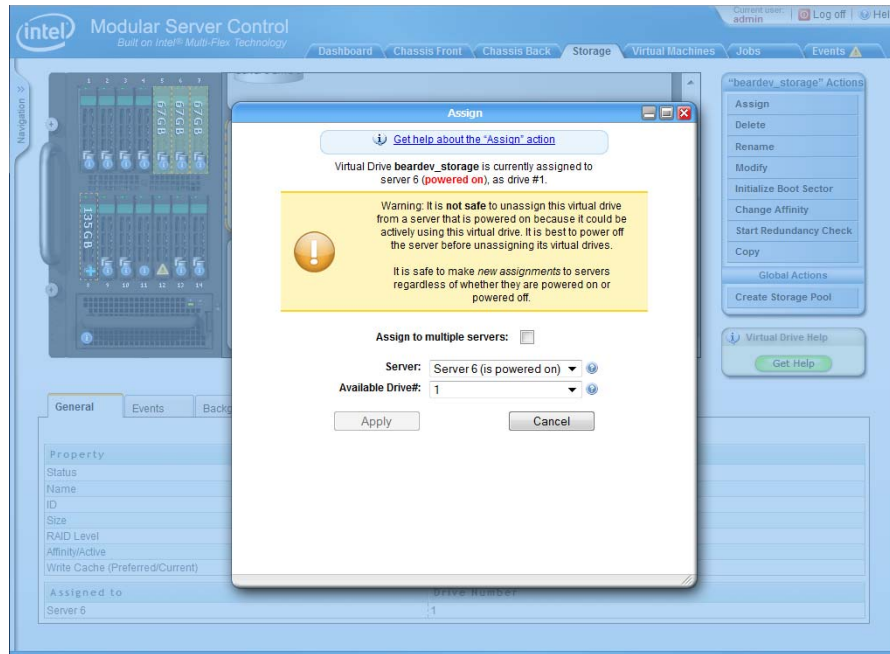

Figure 47. Assign Virtual Drive

3. From the Server list, either select a server or select **Do not assign**.
4. Select the desired drive number if you selected a server in step 3. (Drive #0 is the boot device.)
5. Click Assign to apply the changes.

To assign a virtual drive to multiple servers (available only when the Intel[®] Shared LUN feature has been activated - for instructions to activate the Intel[®] Shared LUN feature, see “Feature Activation” on page 156), follow these steps:

1. From the Storage view, select a virtual drive.
2. Choose Assign from the action menu.
3. Select Assign to multiple servers check box.
4. Select the desired drive number or the **Do not assign** option for each server.
5. Click Assign to apply the changes.

Warning: *It is not safe to unassign virtual drives from a compute module that is powered on because the compute module may be actively using the virtual drive. It is recommended to power off the compute module before reassigning virtual drives to another compute module. However, it is safe to make new assignments to compute modules regardless of whether the compute module is powered on or off.*

Deleting a Virtual Drive

Deleting a virtual drive deletes all data stored on the selected virtual drive. Once a virtual drive is deleted, the space used for the virtual drive will be displayed on the system graphic as unallocated space in the same location as the original virtual drive. A new virtual drive or multiple drives can be created in the unused space as long as the new virtual drive total space requirement does not exceed the space available. The following figure displays the Storage screen after a virtual drive has been deleted from a storage pool that contained more than three virtual drives.

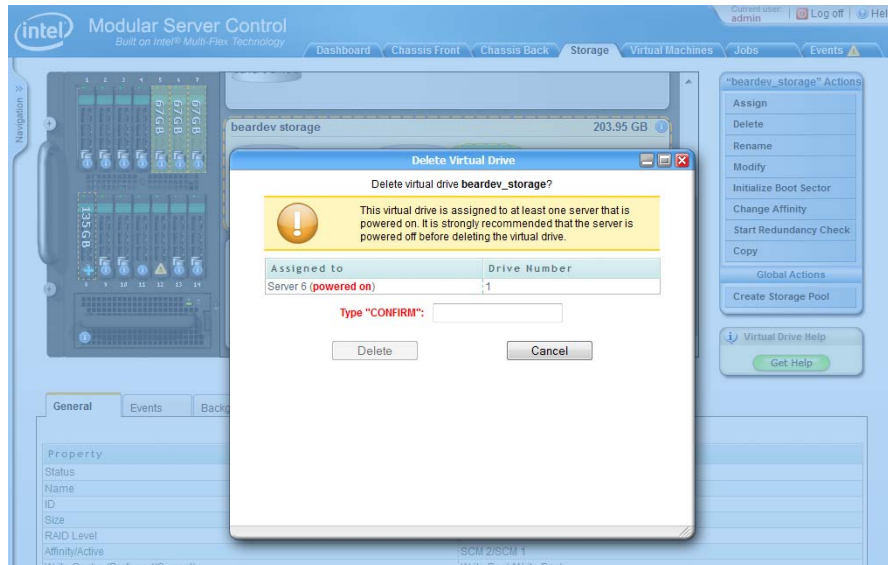

Figure 48. Deleted Virtual Drive

Physical Drives

The Modular Server System has an integrated hard disk drive bay. Storage is shared among all installed servers by grouping physical drives together into storage pools, and then creating virtual drives that are then assigned to individual servers.

To view current status, available actions and product details for all installed hard drives, select a specific hard drive from the system graphic. The selected hard drive will be highlighted on the system graphic. The action box, help box and informational tabs will update to provide all available actions and information for the selected hard drive. Current health and product summary is quickly available by moving the mouse over the Health/Information icon located on the selected hard drive.

Note: For drives that are included in a storage pool, limited drive details are also displayed on the physical drive tab for the assigned storage pool.

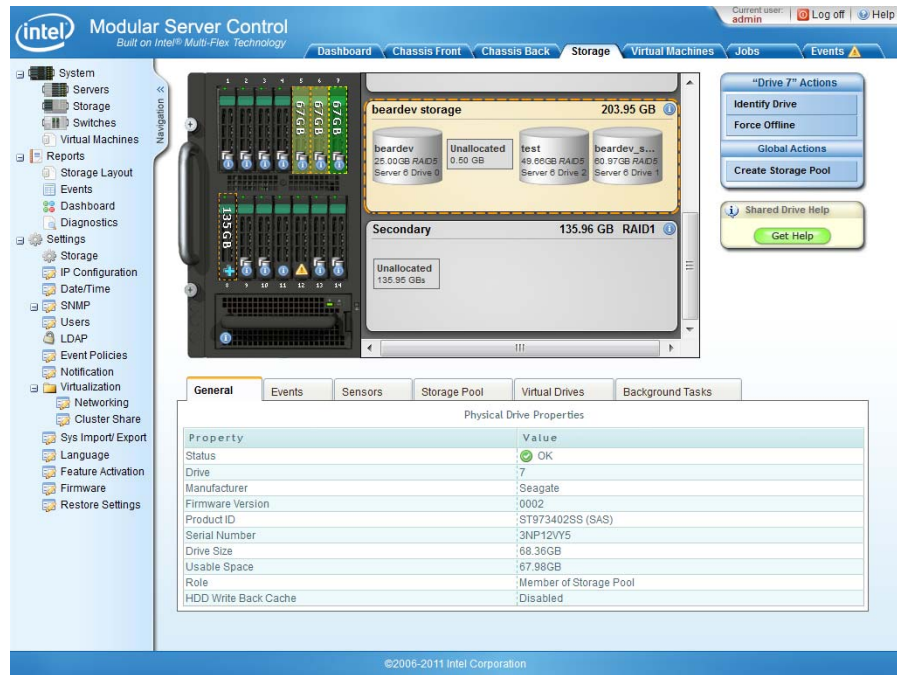



Figure 49. Physical Drives

Health Icons

The health icons are displayed on the graphical representation of the component when the component is selected.

Table 16. Health Icons

| Health Icon | Meaning |
|---|---|
|  | Critical (For details, see the Event Log. For information about accessing the Event Log, see “Events” on page 124.) |
|  | Warning (For details, see the Event Log. For information about accessing the Event Log, see “Events” on page 124.) |
|  | OK |
|  | Hot Spare |
|  | Informational |
|  | Ready for Transport |
|  | Assigned to Storage Pool |
|  | Data Migration or Other Background Operation In Progress |

You may see one of the following health status descriptions as you move the mouse cursor over the health icon:

- **Dead:** The disk was configured to be part of a storage pool or as a spare, but was taken offline due to an extraction or insertion of the drive, a user action (for example, Force Offline), or a drive hardware error. Choose the appropriate action from the Action Menu to bring it back online (for example, the appropriate action may include one of the following actions: Start Rebuild, Force Online, or Cancel Hot spare Action).
- **Stale:** The drive was at one time part of a storage pool, but was taken offline by an error or was transported without being installed, and is no longer required by the storage pool. You may keep the drive in the stale state to preserve the data (for

example, if required for forensic purposes), or clear the stale condition and reuse the disk.

- **Not Accessible:** This physical drive is not usable.
- **Predictive Failure (PFA):** A drive media error has been found by the media patrol background task, or by a SMART error reported for the drive.
- **Rebuilding:** A storage pool is currently being rebuilt on this drive to replace an offline physical drive.
- **Migrating:** A storage pool is currently being expanded that includes this physical drive.
- **Media Patrol Running:** The Media Patrol background task is currently checking this physical drive for errors.
- **Transitioning:** A storage Pool has been rebuilt to a Spare from this physical drive, and now the error on this drive has been cleared, or the drive has been replaced, and the storage pool is being rebuilt back to this drive.
- **Predictive Data Migration Running:** The Predictive Data Migration (PDM) background task is running on this physical drive.

Physical Drive Actions

The actions available for a selected hard drive are displayed to the right of the system graphic. For a description of these actions, refer to the following table.

Table 17. Physical Drive Action Menu

| Global Action Menu Item | Description |
|---|--|
| Create Storage Pool | Designates one or more drives as a storage pool. Global storage actions are available at all times on the storage screen. |
| Selected Physical Drive Action Menu Items | Description |
| Identify Drive | Illuminates the drive ID LED, which enables easy onsite local identification. |
| Force Offline (present if drive is a hot spare or included in an existing storage pool) | Removes the selected drive from a storage pool (if assigned) or from hot-spare status. The status will be indicated as Dead, forced offline. The physical drive must first be forced offline before it can safely be removed. |
| Force Online (available if the drive is offline) | Changes a Dead (Offline) drive back online. This may be needed, in some cases, to restore a drive that was forced offline or if you need to recover data from a drive that went offline from some other cause. |
| Make Hot Spare (present if drive is available (i.e., not included in a storage pool or already a hot spare) | Designates whether the drive is a global or dedicated hot spare. A global hot spare is applied to any storage pool as needed. A dedicated hot spare is assigned to a specific storage pool. See “Create a Hot-spare Drive ” on page 83 for instructions on creating a hot spare. Make Hot Spare is present only if the drive is available (i.e., not included in a storage pool or already a hot spare). |
| Cancel Hot Spare (present if drive role is assigned as either a global or dedicated hot-spare drive) | Removes hot-spare status and sets the drive to available. Available drives can be assigned to existing storage pools, new storage pools or used as hot-spare drives. Cancel Hot Spare is present if a drive role is assigned as either a global or dedicated hot spare. |

Table 17. Physical Drive Action Menu

| Global Action Menu Item | Description |
|--|---|
| Create Storage Pool | Designates one or more drives as a storage pool. Global storage actions are available at all times on the storage screen. |
| Selected Physical Drive Action Menu Items | Description |
| Clear PFA State | Sets the drive state to OK. The Predictive Failure (PFA) State indicates that the background PFA scan found bad data blocks or sectors on the drive. |
| Clear Stale State | Sets the drive state to OK. Clear Stale State is present if a drive is in a stale state (the drive has obsolete array information). This can occur when the drive is taken offline by the user, by physically removing the drive or by a disk error. When the storage pool is rebuilt to correct for the missing drive, the drive is marked as "stale". |
| Start Data Migration | Enables an IT administrator to move data from a defective physical disk drive to a good physical disk drive. |

Physical Drive Details

The tabs displayed in the system graphic provide detailed information on the selected physical drive. For a description of these tabs, refer to the following table.

Table 18. Physical Drive Tabs

| Tab Heading | Description |
|---|---|
| General | The General tab displays a table with the following information: <ul style="list-style-type: none"> • Current status of the physical drive (i.e., status, health, operation state) • Drive product data (i.e., Drive Number, Manufacturer, Serial Number, Size, Firmware, Role) |
| Events | Displays all system events for the selected physical drive. |
| Sensors | Displays a graphical representation of the temperature sensor on the disk drive. |
| Storage Pool (displayed if drive is included in an existing storage pool) | Displays the Storage Pool property table, which includes information such as Storage Pool ID, Storage Pool Name, Status, Total Managed Space, Total Unallocated Space, Number of Physical Drives, Number of Virtual (Logical) Drives. |
| Virtual Drives (displayed if drive is included in a storage pool with virtual drives) | Displays the Virtual Drive to Server Mapping table, which includes virtual drive name, size, RAID level, status, assigned server, and drive number/position. |
| Background Tasks (displayed if drive is included in a storage pool) | Lists any Active Tasks currently involving the physical drive, such as creating, expanding, rebuilding, or migrating storage pools or virtual drives. |

Physical Drive Help

To quickly access additional help regarding physical drive actions and tabs, click on the Get Help button in the Shared Drive help box located under the action box.

Create a Hot-spare Drive

Unused physical hard drives may be designated as hot-spare drives. A hot-spare drive automatically replaces a physical hard drive in a storage pool when it fails, or a when the Predictive Failure Analysis (PFA) indicates a physical drive will fail.

The modular server system supports both dedicated and global hot-spare drives. A dedicated hot-spare drive is assigned to a specific storage pool. If a physical drive fails in the assigned storage pool, the dedicated hot-spare drive will replace the failed drive as long as the hot-spare drive is equal to or greater than the size of the failed drive. A global hot spare can replace any failed drive in any storage pool as long as the global hot-spare drive size is equal to or greater than the failed drive size. Both dedicated and global hot-spare drives will revert to being a hot-spare drive once the failed physical drive is replaced.

Once a hot spare is created, the following information is updated:

- The information icon for the physical drive changes to the hot spare icon,  .
- The Role description on the General Tab for the selected physical drive indicates whether the physical drive is a dedicated or global spare .
- If the drive is a dedicated hot-spare drive, it will be listed on the Spares tab for the assigned Storage Pool.
- If the drive is a global hot-spare drive, it will be listed on the Spares tab under all Storage Pools.

To create a hot-spare drive, follow these steps:

1. Click Storage in the top menu or click System > Storage in the left navigation panel to open the Storage screen.
2. Select an available or unused physical hard drive from the system graphic.
This is a drive that is currently not used in a storage pool.
3. From the “Drive <#>” Action menu, select Make Hot Spare.
4. Configure the hot spare as either a global hot spare (available to all storage pools) or a dedicated hot-spare drive (assigned to a specific storage pool) and click Apply.

Once the hot spare has been created, a successful action dialog will be displayed and the information icon will change to the hot spare icon,  .

Intel® Gigabit Ethernet Switch Module 1 and 2

The Intel® Modular Server System comes with one Intel® Gigabit Ethernet Switch Module installed in the rear module bay labeled SWM1. The modular server system can support up to two Intel® Gigabit Ethernet Switch modules. Each switch module has 12 internal ports and ten external ports. By default, the Intel® Gigabit Ethernet Switch Module assigns all internal and external ports to a default virtual LAN (VLAN).

The internal ports connect the compute modules to the switch modules. There are two internal ports assigned to each compute module bay. The internal ports are labeled “Server 1: Port 1”, “Server 1: Port 2”, “Server 2: Port 1”, ... “Server 6, Port2”. All internal ports are enabled by default. Using the Configure Ports action dialog, an IT administrator can assign any internal port to a VLAN whether or not the compute module is installed.

The external ports are visible from the rear of the system and must be physically patched by an IT administrator to an external network device. Using the Configure Ports action dialog, an IT administrator can enable or disable any external port, assign an external port to a VLAN, change the external port speed, and enable or disable Spanning Tree. The external ports are numbered as shown in [Figure 50](#).

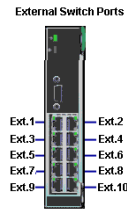

Figure 50. External Ports

The Intel® Modular Server Control UI enables an IT administrator to modify internal and external port settings, view health information and product details, and launch an advanced configuration interface. To view current status, available actions, and product details for an installed Intel® Gigabit Ethernet Switch Module, either click System > Switches in the left navigation panel or click the Chassis Back tab to display the back of the system and select the specific switch module from the back of the system graphic. The content displayed on the informational tabs, action box, and help box will be updated with product-specific information and actions available for the selected switch module highlighted in green. The current health and product summary information is quickly available by moving the mouse over the Health/Information icon located on the selected switch module.

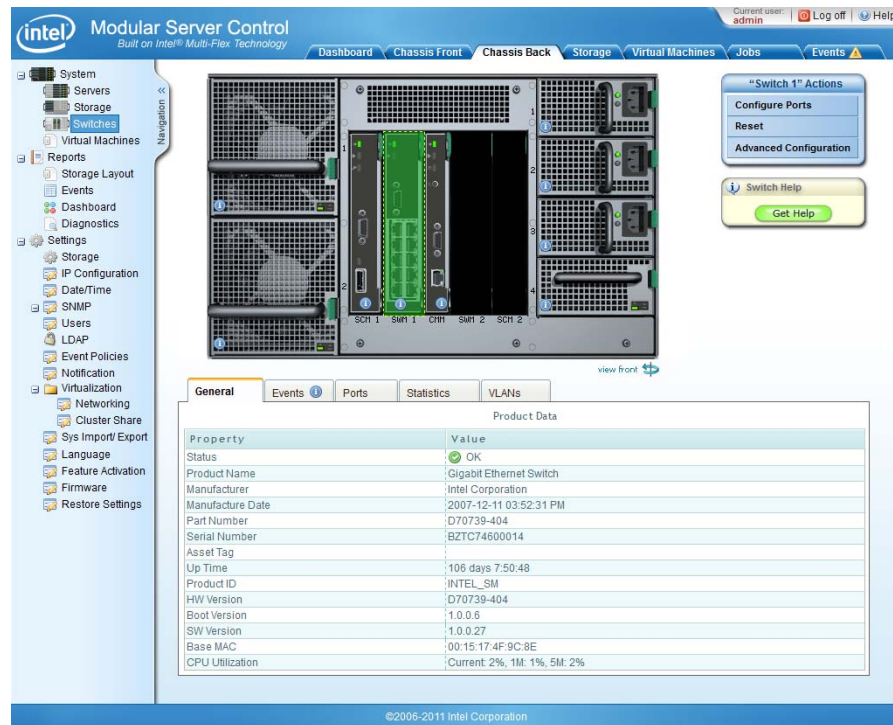







Figure 51. Intel® Gigabit Ethernet Switch Module View

Health Icons

The health icons are displayed on the graphical representation of the component when the component is selected.

Table 19. Health Icons

| Health Icon | Meaning |
|---|---|
|  | Critical (For details, see the Event Log. For information about accessing the Event Log, see “Events” on page 124.) |
|  | Warning (For details, see the Event Log. For information about accessing the Event Log, see “Events” on page 124.) |
|  | Information |
|  | OK |
|  | Firmware update or other background activity |

Intel® Gigabit Ethernet Switch Module Actions

The actions available for a selected switch module are displayed to the right of the system graphic. For a description of these actions, refer to the following table.

Table 20. Switch Module Action Menu

| Action Menu Item | Description |
|------------------------|---|
| Configure Ports | Configures port and Virtual LAN (VLAN) settings within the Intel® Modular Server Control UI. This action provides quick access to frequently configured port and VLAN options. |
| Reset | Enables remote reset of the selected switch module. |
| Advanced Configuration | Launches a third-party Advanced Switch Configuration interface in a new window to view all switch configuration options. Refer to the <i>Intel® Gigabit Ethernet Switch AXXSW1GB User Guide</i> for more information on how to use the Advanced Configuration Switch interface. |

Intel® Gigabit Ethernet Switch Details

The tabs displayed below the system graphic provide detailed information for the selected switch module. For a description of these tabs, refer to the following table.

Table 21. Switch Module Tabs

| Tab Heading | Description |
|----------------------|--|
| General | Displays current status and general Intel® Gigabit Ethernet Switch information, such as product ID, uptime, hardware and software versions, and MAC address. |
| Events | Displays all system events for the selected Intel® Gigabit Ethernet Switch. |
| Ports | Displays table of key port settings, including Port ID, VLAN ID, Enabled/Disabled Status, Link Status, Set Speed, Current Speed, VLAN Mode, and Spanning Tree (STP). |
| VLANs (Virtual LANs) | Displays a table of configured VLANs for the selected switch, including VLAN number, VLAN name, and members. |
| Statistics | Displays a table of statistics for the selected switch, including Port ID, Input, Output, and Error Information. |

Intel® Gigabit Ethernet Switch Module Help

To quickly access additional help regarding the Intel® Gigabit Ethernet Switch Module screen, actions, and tabs, click on the Get Help button in the Switch help box located under the Actions box.

Configuring an Intel® Gigabit Ethernet Switch

Intel® Gigabit Ethernet Switches come pre-configured with all available ports enabled in a single default VLAN. No additional configuration is required to connect the Intel® Modular Server System MFSYS25V2 to a network.

Two options are available to modify the default switch configuration:

- The Configure Ports action menu item enables an IT administrator to quickly and easily modify port and Virtual LAN (VLAN) settings. [Figure 52](#) displays the Configure Ports dialog box within the Intel® Modular Server Control UI.
- To make additional changes to the switch configuration, click Advanced Configuration in the Actions menu. The Advanced Configuration action launches a separate switch configuration interface in a new window. Refer to the *Intel® Gigabit Ethernet Switch AXXSWIGB User Guide* for more information on how to use the Advanced Configuration.

Configure Ports Dialog

The Configure Ports dialog enables an IT administrator to modify the following parameters for each Intel® Ethernet Switch Module:

- Enable or disable external ports
- Assign any port (internal or external) to a VLAN
- Set the external port Speed
- Enable or Disable Spanning Tree on external ports

Steps to assign an internal or external port to a VLAN:

1. Click System > Switches in the left navigation panel.
2. Select the switch module to be configured.
3. Click Configure Ports in the selected switch Action menu.
4. To add ports to a new or existing VLAN, type the VLAN number in the box under the VLAN column for the specific port.

Each individual port can be assigned to only one VLAN at a time.

The compute module does not have to be present in the system in order to assign the internal ports to a VLAN.

5. Click Apply.

The Configure Ports dialog simplifies the VLAN configuration process by removing the step to create a VLAN before assigning ports. The VLAN number entered in the Configure Ports dialog in step 4 can either be a new VLAN number or an existing VLAN number, since the Apply process creates the VLAN and also assigns the ports.

The following image illustrates the Configure Ports dialog.

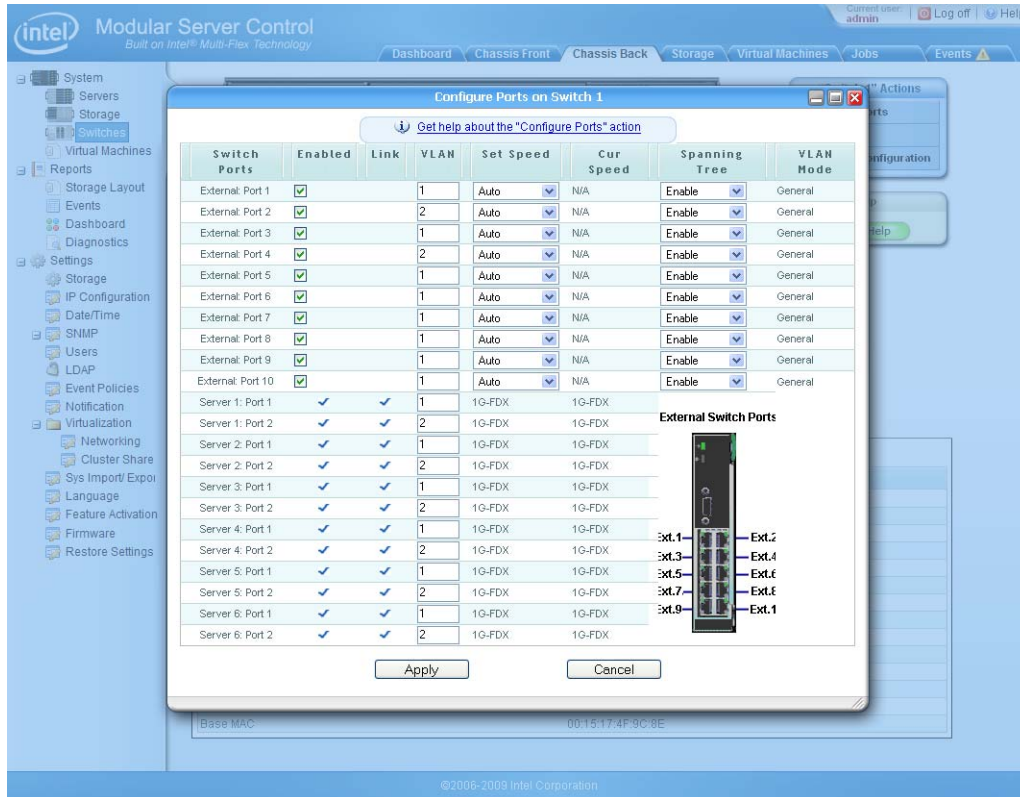

Figure 52. Configure Ports Dialog Box

Reset

The Reset action resets the switch module. All settings will revert to the last saved settings for the switch. Alternatively, the user may opt to revert the switch settings to factory defaults.

Note: Resetting the switch will interrupt all server and management module network traffic for up to two minutes.

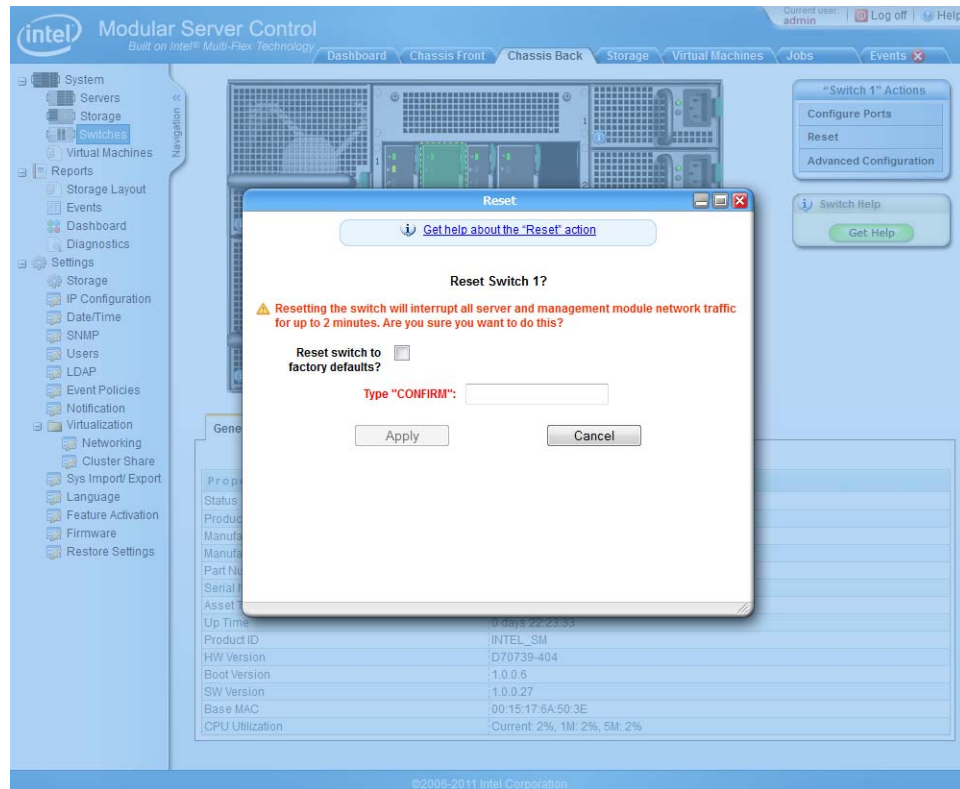

Figure 53. Reset Switch Screen

To reset a Gigabit Switch Module, do the following:

1. Click on the Chassis Back tab in the top navigation bar.
2. Select a Gigabit Switch Module.
3. From the actions menu, choose Reset.
4. Check the Reset switch to factory defaults to return the switch to its original configuration after resetting.
5. Type CONFIRM into the text box provided.
6. Choose Apply to reset the server.

Advanced Configuration

The Advanced Configuration action launches the embedded switch UI for the Intel® Gigabit Ethernet Switch Module in a new window. This interface exposes all configuration settings for the switch. Configuration settings modified in either the Advanced Configuration or the Intel® Modular Server Control UI are displayed in both interfaces.

The following image illustrates the Advanced Configuration screen.

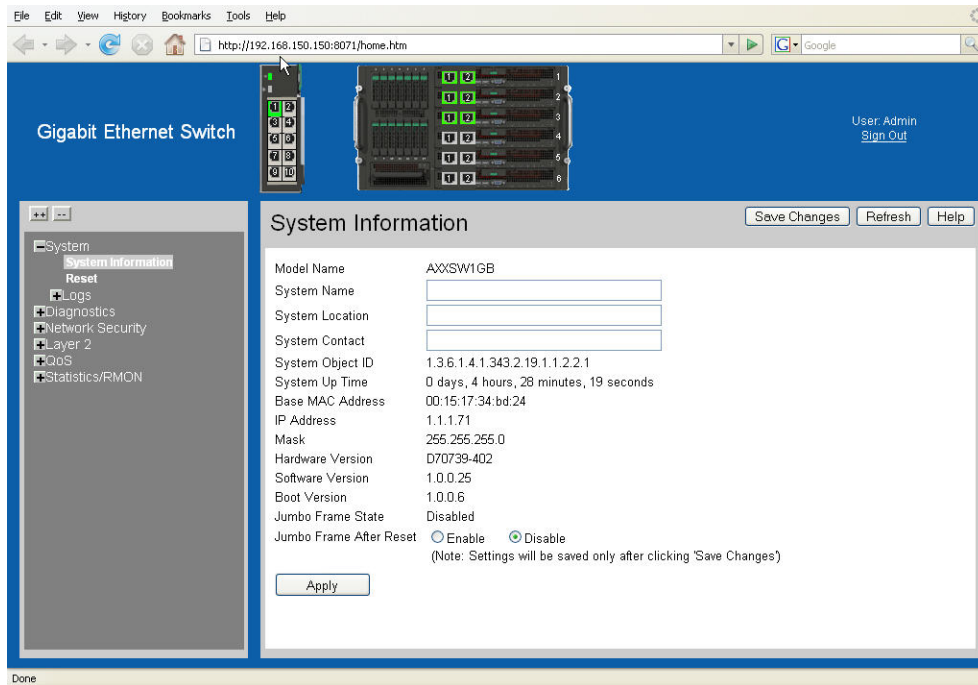

Figure 54. Advanced Configuration Screen

Virtual Machines

A powerful feature of the Intel® Modular Server System is the ability to use Virtual Machines. When activated, virtualization extends the use of the compute modules in the Modular Server. The existing physical hardware resources are pooled together, and these resources are then divided up into individual virtual machines.

Virtual machines act as individual servers, each capable of hosting its own operating system, running software, and serving data.

Some of the advantages of using virtualization:

- The ability to run multiple servers using the resources of one compute module.
- Because the Modular System uses a modular file system, the virtual machines can be moved freely between compute modules with negligible downtime. Moving a virtual machine is as easy as dragging and dropping, and useful in cases such as hardware failure, or heavy traffic.

Steps to Setting up Virtual Machines on the Modular Server

1. Activate the Intel® Modular Server Virtualization Manager Features. See the *Feature Activation* section for information on how to authorize the virtualization features on the Intel® Modular Server system on Page 156.
2. Virtualize Compute Modules: This step is performed on the System > Servers screen. See the *Virtualize Compute Modules* section for further information on Page 92.
3. Configure the Cluster Share to allow installation of software and the transfer of data to virtual machines. This step is performed on the Settings > Virtualization > Cluster Share screen. See the Cluster Share section for instructions on Page 152.
4. Configure Networking: This step is performed on the Settings > Networking screen. See the *Configure VM Networking* section for instructions on Page 148.
5. Create Virtual Machines: This step is performed on the System > Virtual Machines screen. See the *Virtual Machine Screen > Creating a Virtual Machine* section for detailed instructions on Page 101.
6. Install Software on a VM: See an overview of the process on Page 110.

Virtualize Compute Modules

The first step in creating virtual machines is to Virtualize compute modules. The Virtualize action prepares a compute module for hosting virtual machines. Once virtualized, the module's hardware resources are allocated to a VM pool. Virtual machines are created from this pool, much like virtual drives are created in storage pools.

Each compute module hosts a single VM pool. If more than one compute module is virtualized, virtual machines may be moved and migrated between pools as needed.

Steps to virtualizing a compute module:

1. Click System > Servers from the side navigation menu, or the Chassis Front tab from the top menu.

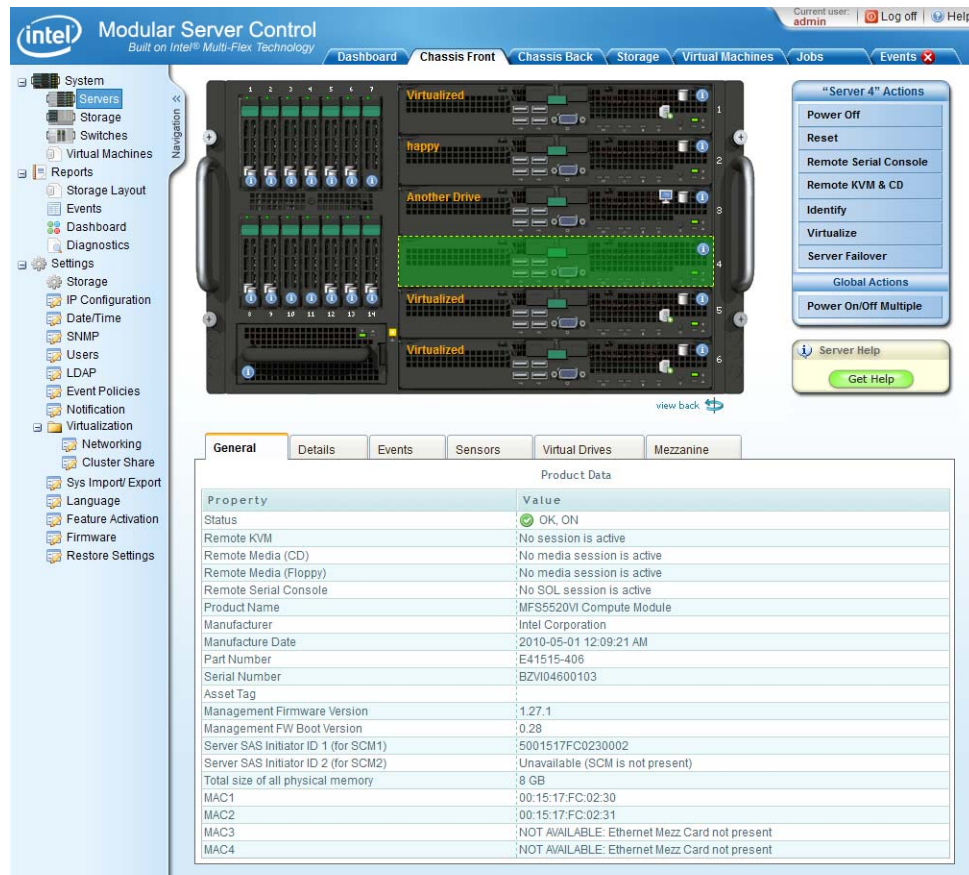

Figure 55. Servers Screen

2. Select the target Compute Module. In order to virtualize a server, it must be powered off. If the server is on, use the Power Off action from the menu before continuing.
3. Select Virtualize from the action menu.

Note: The first time a server module is virtualized on a Modular Server, the user is required to create a VM Storage Pool to provide system-wide VM configuration and data storage. This will take approximately 15 minutes. After the VM Storage Pool is created, subsequent compute module virtualization will only take a minute or two.

Note: To create additional VM Storage Pools, use the Create Storage Pool action, using the VM Storage Pool option: “Creating a Storage Pool” on page 63

4. If this is the first compute module virtualized, the following dialog box appears:

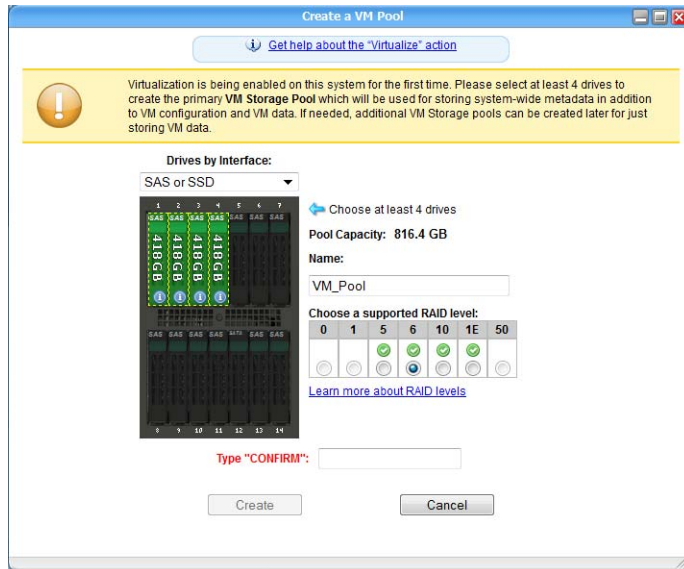

Figure 56. Create a VM Storage Pool screen

5. Enter a name for your VM Pool. Letters, numbers, and dashes are allowed, spaces are not allowed.
6. Select drives to be included in the VM Storage Pool by clicking on the available drives shown in the chassis graphic. You may also select drives by their interface (SAS, SSD) from the Drives by interface drop down menu. At least 4 physical drives must be included in the storage pool.
7. Choose a RAID level from the options presented. The RAID level is dependent on the number of drives in a pool, and available levels will be automatically updated as drives are selected.
8. After reviewing the information entered, type CONFIRM in the text box provided.
9. Choose Create. This may take up to 15 minutes. A new popup showing the progress of the virtualization process will appear:

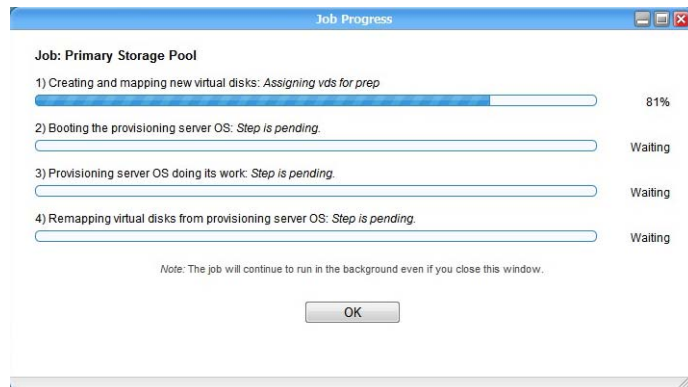

Figure 57. Virtualization Progress Bar

10. After the progress bar is completed, select OK.
11. The compute module will now reboot, and reprovision the virtualization layer. This may take some time, depending on available system resources. When completed, a pop up window informs the user as to the success or failure of the process:

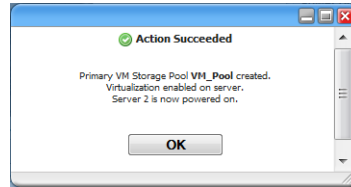

Figure 58. VM Pool result popup

12. Select OK.
13. The compute module will now reboot, and upon completion, will now be fully virtualized.

Virtual Machine Pools

Once a Server Module is virtualized, its resources are made available in the VM Pool. Each compute module hosts a single VM pool, so up to six pools may be created.

To configure a VM Pool or create Virtual Machines from it, either click the top menu Virtual Machines tab, or click System > Virtual Machines in the left navigation panel.

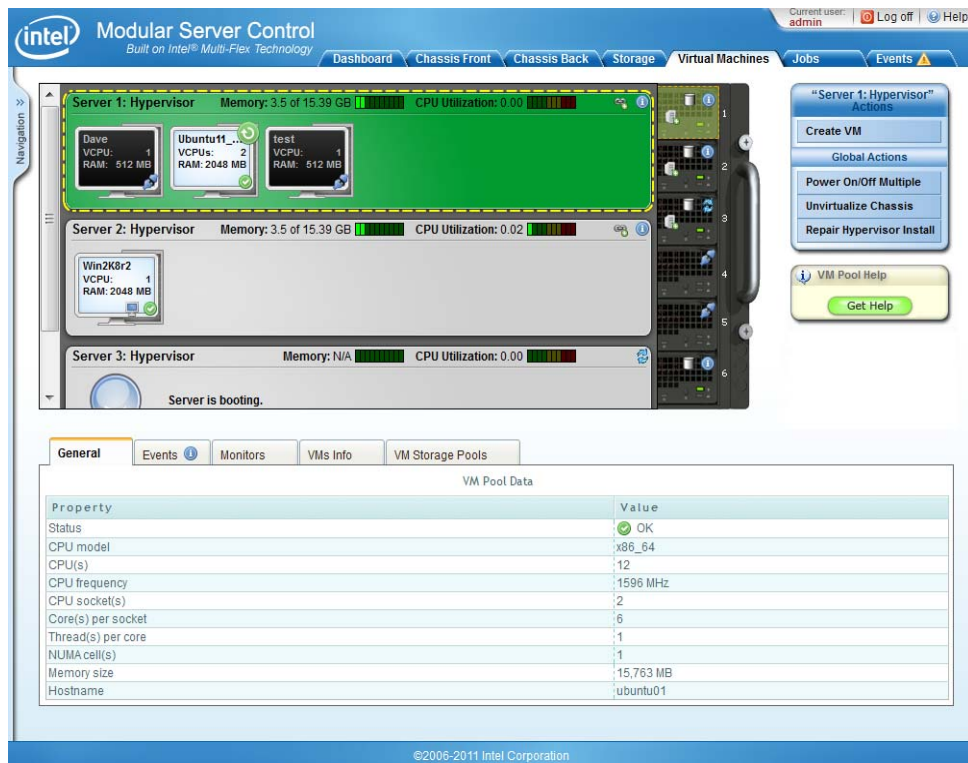







Figure 59. VM Pool Screen

Health Icons

The health icons are displayed on the graphical representation of the component.

Table 22. Health Icons

| Health Icon | Meaning |
|---|---|
|  | Critical (For details, see the Event Log. For information about accessing the Event Log, see “Events” on page 124.) |
|  | Warning (For details, see the Event Log. For information about accessing the Event Log, see “Events” on page 124.) |
|  | Information |
|  | OK |
|  | Firmware update or other background activity |

VM Pool Actions

The actions available for a selected VM Pool are displayed to the right of the system graphic. For a description of these actions, refer to the following table:

Table 23. VM Pool Action Menu

| Action Menu Item | Description |
|---------------------------|---|
| Create VM | Allows a user to create a virtual machine from the VM Pool. |
| Power On/Off Multiple | Allows a user to power on/off multiple Virtual Machines at once. |
| Unvirtualize Chassis | Removes all virtualization features from the Modular Server. |
| Repair Hypervisor Install | Do not use this action unless advised to do so by a support representative. This attempts to repair the hypervisor installation, and may result in loss of data from the ISO Store. Contact your Intel support representative if you are having issues with virtualization. |

VM Pool Details

The tabs displayed below the system graphic provide detailed information for the selected VM Pool. For a description of these tabs, refer to the following table:

Table 24. VM Pool Tabs

| Tab Heading | Description |
|--------------------|---|
| General | The General tab displays the status and information on the resources available in the virtual machine pool. |
| Events | Lists the systems events related to the virtual machine pool. |
| Monitors | Displays graphical charts tracking the performance of the virtual machine pool. |
| VMs Info | Displays the status and detailed information on the virtual machines in the pool. |
| VM Storage Pools | Lists all storage pools and their virtual drives. |

VM Pool Help

To quickly access additional help regarding the storage pool screen, actions, and tabs, click on the Get Help button in the VM Pool help box located under the actions.

Virtual Machine Screen

Virtual machines are created in the VM Pool, using the computing resources of the compute module hardware. Once created, an icon for the virtual machine appears in the pool. Selecting the icon allows a user manage or configure the virtual machine as needed.

A VM Pool may hold a number of virtual machines. In addition to the actions available to VMs, the icons may be dragged and dropped between VM Pools freely.

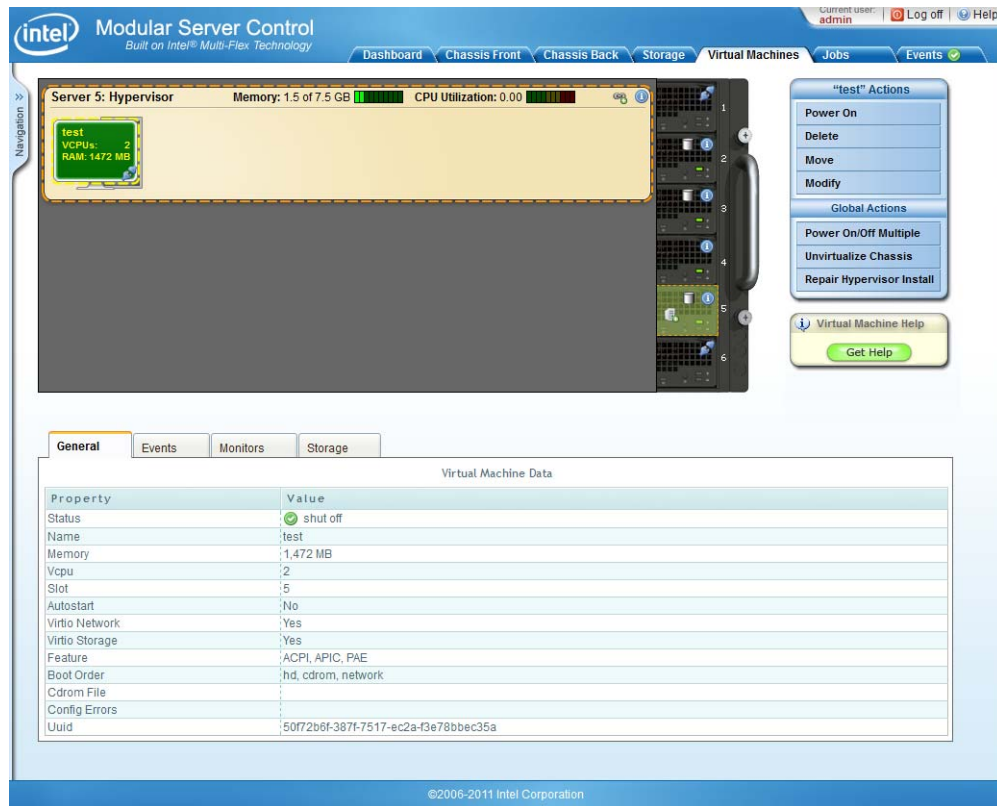







Figure 60. Virtual Machines Screen

Health Icons

The health icons are displayed on the graphical representation of the component.

Table 25. Health Icons

| Health Icon | Meaning |
|---|---|
|  | Critical (For details, see the Event Log. For information about accessing the Event Log, see “Events” on page 124.) |
|  | Warning (For details, see the Event Log. For information about accessing the Event Log, see “Events” on page 124.) |
|  | Information |
|  | OK |
|  | Firmware update or other background activity |

Virtual Machine Actions

The actions available for a selected Virtual Machine are displayed to the right of the system graphic. For a description of these actions, refer to the following table:

Table 26. Virtual Machine Action Menu

| Action Menu Item | Description |
|---------------------------|---|
| Power On | Turns on a virtual machine. |
| Shutdown | This action powers off the virtual machine. Shutdown may be either Graceful or Forced. The graceful shutdown option sends a request to the operating system to shutdown the hardware. A forced shutdown immediately powers down the VM. CAUTION: The Forced option may cause data loss on the server. It is strongly recommended to use the graceful shutdown option. |
| Pause | The virtual machine will halt operation until a user chooses to Resume the server. |
| Resume | Begins the operation of a paused virtual machine. |
| Delete | This action will delete a virtual machine. |
| CD-Rom Insert/Eject | This action makes available a CD or disk image for use by the virtual machine. |
| Live Migration VM | This tool is used to migrate a virtual machine temporarily or permanently to another VM Pool. |
| Remote KVM | Allows a user to open a remote Keyboard, Video, and Mouse session to the virtual machine in a terminal window. |
| Terminate KVM | Kills Keyboard, Video, and Mouse sessions currently logged into VM. |
| Move | Use this action to move a virtual machine from one VM Pool to another. |
| Modify | Use this action to change the configuration of a virtual machine. |
| Power On/Off Multiple | Allows a user to power on/off multiple Virtual Machines at once. |
| Unvirtualize Chassis | This action removes the Virtual Machines and all related features. NOTE: All associated data is lost forever. |
| Repair Hypervisor Install | Attempts to repair non-responsive or buggy virtualization states. |

Virtual Machine Details

The tabs displayed below the system graphic provide detailed information on the selected Virtual Machine. For a description of these tabs, refer to the following table.

Table 27. Virtual Machine Tabs

| Tab Heading | Description |
|-------------|---|
| General | Displays the status and system information associated with the virtual machine. |
| Events | Displays all the system events generated by the virtual machine. |
| Monitors | Displays virtual machine performance data in graphical form. |
| Storage | Displays storage in use by the virtual machine. |

Virtual Machine Screen Help

To quickly access additional help regarding the Virtual Machine screen, actions, and tabs, click on the Get Help button in the Virtual Machine help box located under the actions.

Steps to Create a Virtual Machine

1. Select the Virtual Machines tab from the top navigation menu.
2. Choose the VM Pool in which to create the virtual machine.

Note: *The compute module hosting the VM Pool must be powered on in order to create a virtual machine.*

3. Choose Create VM from the action menu.
4. A configuration window will launch, with the areas of configuration broken down by tabs. Fill out each tab:

Basic Tab:

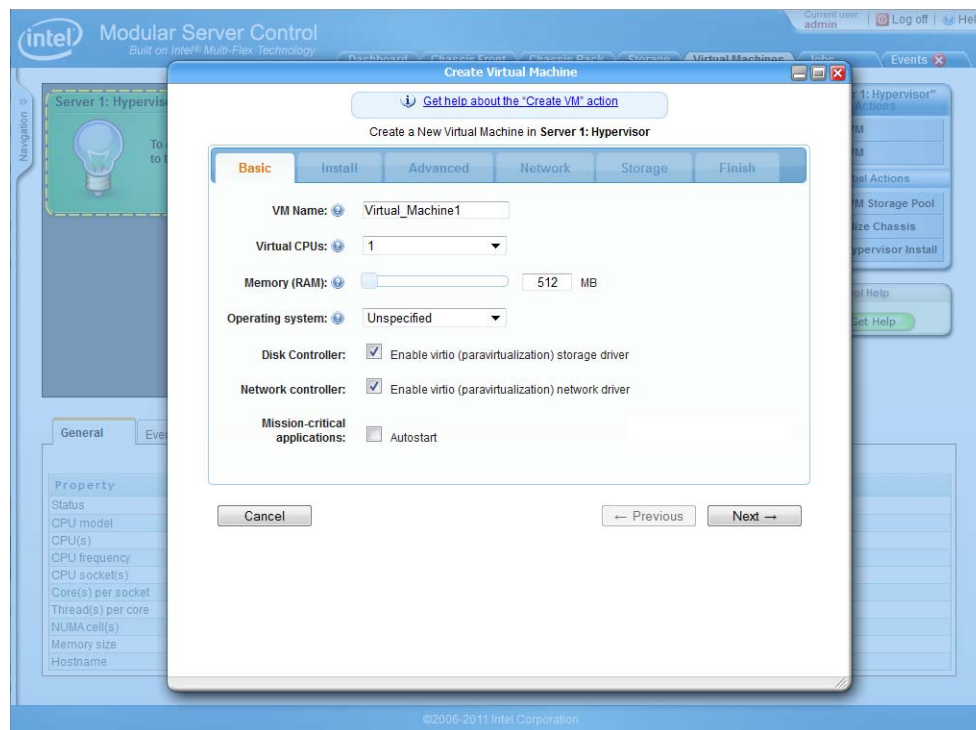

Figure 61. Create VM Screen: Basic Tab

The basic tab sets the general hardware parameters for the Virtual Machine.

1. Enter a name for the virtual machine in the text box provided. Letters, numbers, and dashes are allowed, spaces are not allowed.
2. Enter how many virtual CPUs to be allocated to the Virtual Machine.
3. Use the slide bar to set the amount of RAM allocated to the Virtual Machine.
4. Select the Operating System to be installed on the VM. This is important to specify if Windows OS is going to be used, as the operating system doesn't support all of the VM creation parameters and may fail otherwise.

Note: *Windows OS only supports the adding of one LUN during creation. Additional LUNs may be added using the Modify Action after creation.*

5. Virtio drivers are available for the Disk Controller, and Network Controller for both Linux and Windows. These drivers are designed for enhanced performance in a virtualized environment and improve OS speed by removing the need to emulate hardware by the VM. To use OS native drivers, uncheck the boxes.
6. Check the boxes of any Mission Critical Applications to be used. If Autostart is checked, the virtual machine will attempt to restart if it unexpectedly fails.

Install Tab

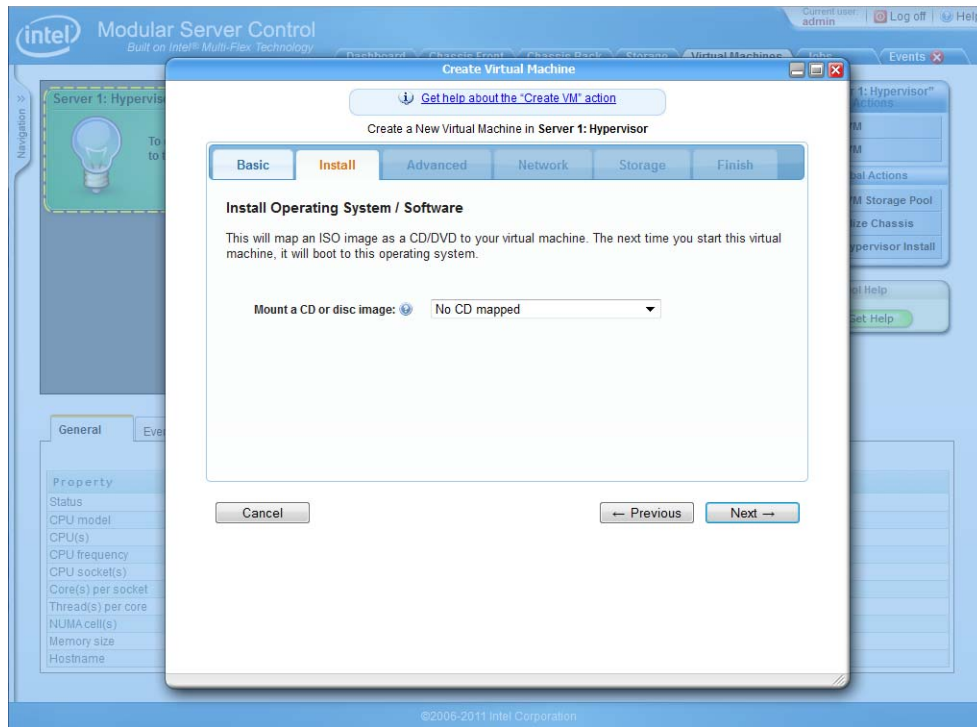

Figure 62. Create VM Screen: Install tab

The Install Tab allows a user to make a software image available to the Virtual Machine. Mounting the image in this way is much like inserting a CD into a physical machine. Once it is mounted, the VM may be booted and an OS installed using the software image.

The image remains available to the virtual machine until it is unmounted with the Modify VM action.

The ISO Store is an area on the Modular Server that stores software images for use by virtual machines. If the ISO Store is empty or has not been set up yet, refer to “[ISO Store](#)” on page 109.

To Mount a CD Image to the Virtual Machine:

1. Select Internal ISO Store, Windows Share from the Mount a CD or disc image drop down menu.
2. Select the Choose ISO button. This launches the ISO Store, the area designated for storing software for VMs.
3. Double click on the image to be used.
4. Choose the Apply button.

Advanced Tab

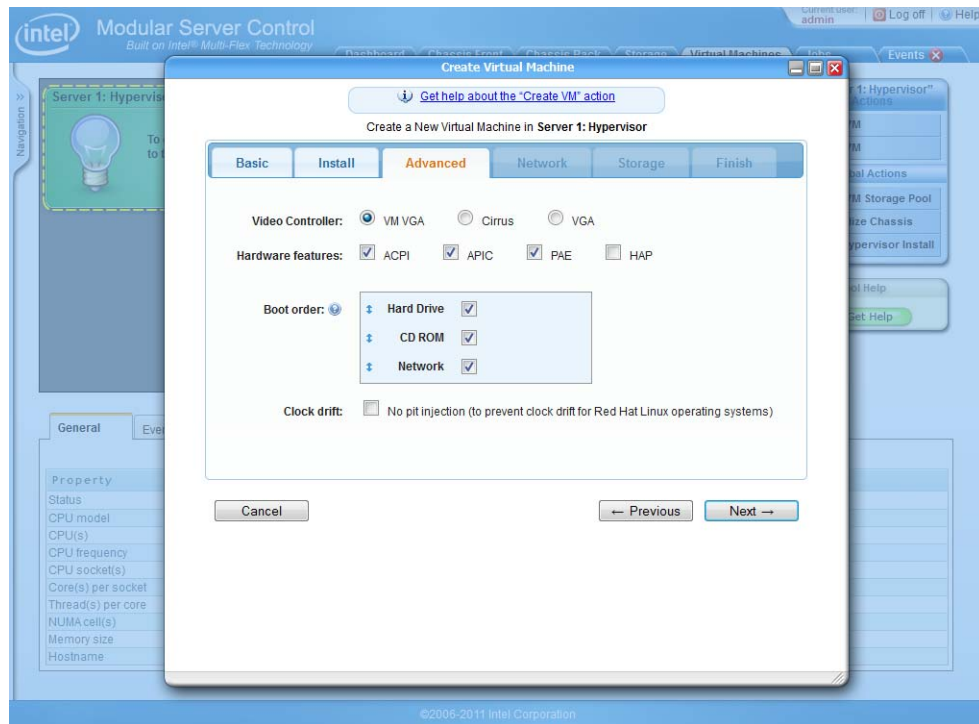

Figure 63. Create VM Screen: Advanced Tab

The Advanced tab collects the settings traditionally found in the hardware BIOS.

1. Choose the Video Controller to use with the Virtual Machine. If the VM VGA driver is not supported by the host OS, use the Cirrus or VGA driver.
2. Check the boxes of the Hardware Features used by the operating system on the virtual machine:
 - ACPI - allows the OS to take advantage of advanced power management features.
 - APIC - an advanced programmable interrupt controller for use in symmetric multiprocessor environments.
 - PAE - for operating systems needing to access physical address space larger than 4 gigabytes.
 - HAP - improves performance for operating systems supporting processors with Hardware Assisted Paging capabilities. This feature also needs to be activated in the BIOS of the VM.
3. Under the Boot Order heading, use the check boxes to enable boot devices. Drag and drop the devices to set the boot order.

Note: The Virtual Machine is unable to boot from a USB attached device.

- Hard Drive - The Virtual Machine will boot from the virtual drive designated as LUN 0 in the Storage tab. If not yet defined, this drive will be created before the Create VM action is finished under the Storage Tab.
 - CD ROM - The Virtual Machine will boot from the remote drive or ISO image designated in the Install Tab, or by the CD-ROM Insert/Eject action.
 - Network - The Virtual Machine will look for a PXE server on the network from which to boot.
4. If the user plans on installing Red Hat Linux on this virtual machine, check the Clock Drift box. Otherwise, the OS will not be able to keep accurate time.

Network Tab

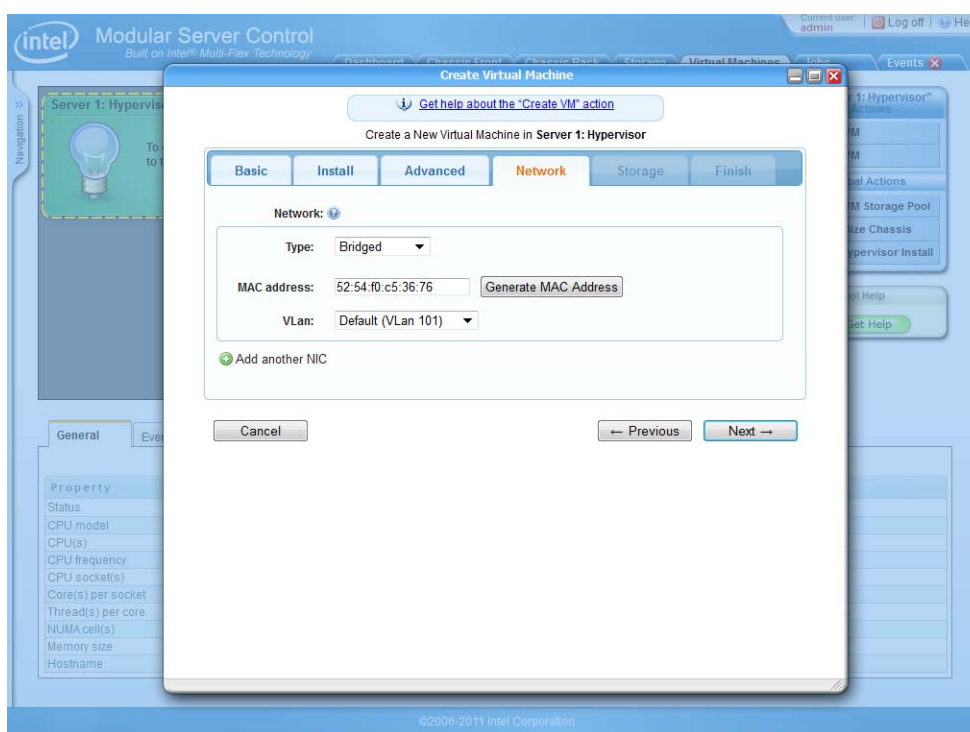

Figure 64. Create VM Screen: Network Tab

The Network tab sets the network configuration of the Virtual Machine. A VM may have up to four NICs, which may be used for isolating traffic between applications, for security, or however the administrator desires to route network traffic.

The default setting for a VM is a bridged NIC, which appears as a basic Ethernet connection using a DHCP connection on Vlan 101 with no filter, so all network traffic is passed through.

When using Simplified Networking (the default networking setting of the Modular Server), Compute Modules and Virtual Machines are automatically assigned Vlan 101. This allows them to communicate with each other and the outside world. To add more Vlans, or implement more complex networking options, see [“Configure Networking” on page 148](#)

To Configure the Network tab:

1. Assign up to 4 virtual network connections to the virtual machine. To add a connection, choose Add another NIC link. A user may want to add additional NIC connections to shape network traffic to better suit networking needs, such as:
 - Link Aggregation - The combining of multiple adapters into a single channel to provide greater bandwidth.
 - Traffic Routing – Different NICs may be set up to service different subnets.
 - Fault Tolerance - Uses one or more secondary adapters to take over for the primary adapter should the first adapter fail. Designed to ensure server availability to the network. Some software such as SMB is able to take advantage of this automatically.

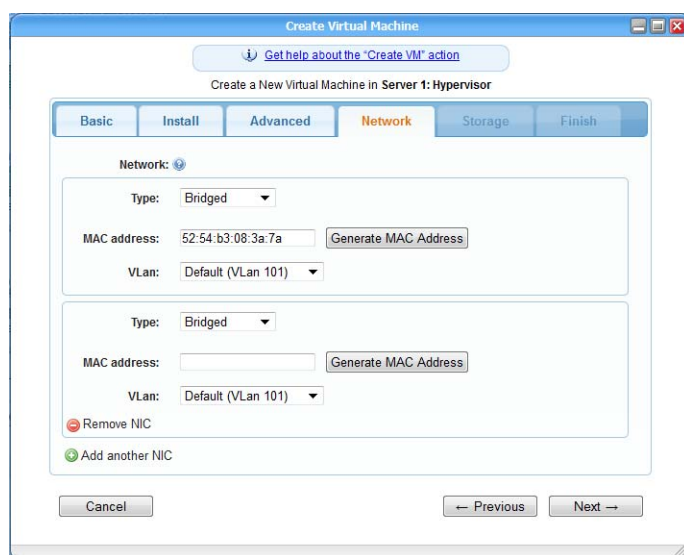

Figure 65. Network Tab: Two NICs

2. For each NIC, choose the Type from the drop down menu.
 - A Bridged connection appears as a physical host on the network, and acts as a basic network connection for sending and receiving data.
 - A NAT connection uses the IP address of the compute module. Data sent to the address is routed to the appropriate VM locally. Other VMs on the NAT network may address it directly.
3. Enter a MAC address into the text box. This is the unique networking identifier for this virtual device. To generate a new MAC address automatically, click the Generate MAC Address button.

4. Select a Vlan from the drop down menu. The Modular Server comes preconfigured with default Vlans, but more may be defined on the Networking configuration screen “Virtual Switches” on page 150. All Vlans configured in the Networking configuration screen will appear here, as well as these defaults:
 - Default (Vlan 101) - This default selection sets up a virtual switch with a single Vlan. This choice is pre-configured to work with most networks, and allows both internal and external traffic.
 - User 2 (Vlan 102) - This is selection is configured like the Default selection, using a different user. This will work the same as Default and may be set up to add redundancy to the VM's network connections.
 - Internal Cluster (Vlan 4081) - This selection is configured to communicate with the internal Modular Server network.
 - Backup & CDP (Vlan 4082) - This selection is configured to add a dedicated network connection for real time backup & CDP services.

Storage Tab

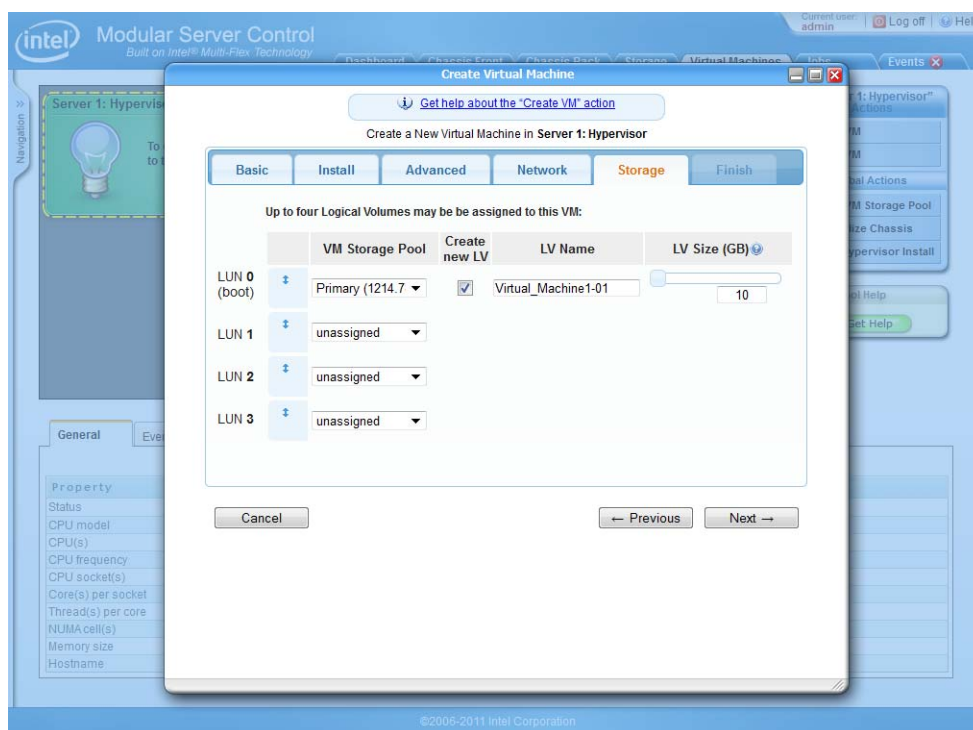

Figure 66. Create VM Screen: Storage Tab

The Storage tab sets up the virtual drives the Virtual Machine will use.

Virtual Machines use specific VM Storage Pools for their storage needs. When virtualizing the first compute module on the Modular Server, a VM Storage Pool is automatically created. Subsequent VM Storage Pools may be created using the Create Storage Pool action.

1. Assign up to 4 virtual drives to the VM. These act as hard drives for the newly created virtual machine. LUN 0 is the boot partition, accessed when the virtual machine is started.

Note: Only one LUN may be assigned to a VM hosting a Windows OS. More may be added after the Create Virtual Machine action is completed, using the Modify Virtual Machine action.

2. For each virtual drive, select a VM Storage Pool to use from the drop down menu.
3. Check the Create new LV box to make a new virtual drive for the virtual machine to use. To use an already existing virtual drive in the pool, uncheck the box.
4. If creating a new virtual drive, enter a name in the LV Name text box. If using an existing virtual drive, a drop down menu will appear under LV Name from which the user may select an available drive.
5. To change the size of a virtual drive, or set the size for a new one, use the slider under the LV Size (GB) column. You may also type in the number in gigabytes into the text box under the slider.

Finish Tab

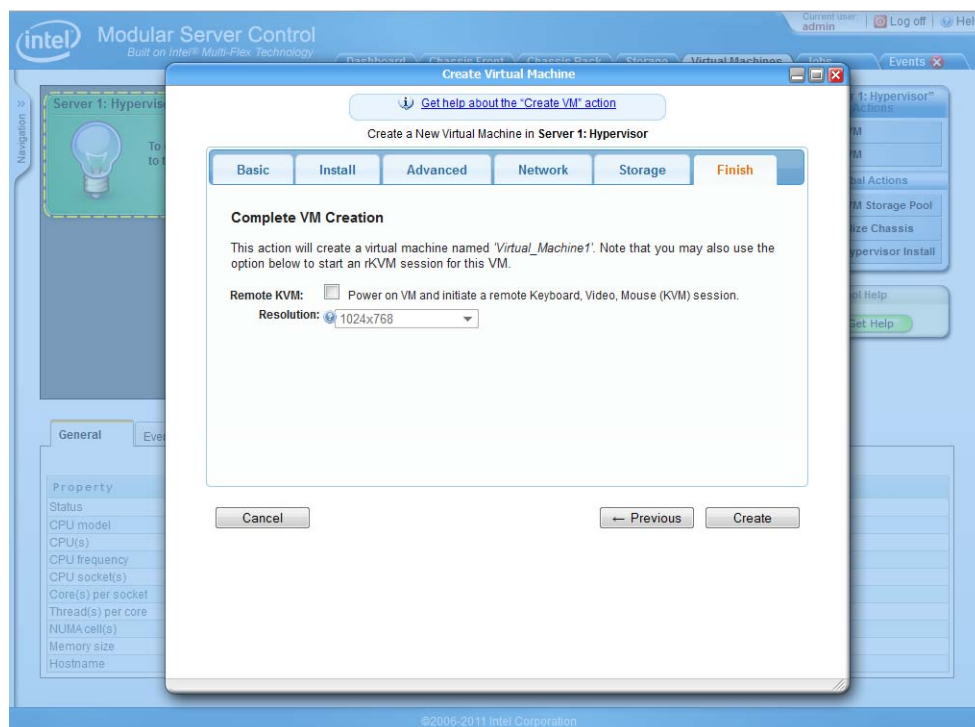

Figure 67. Create VM Screen: Finish Tab

Choose the Create button to complete the Create Virtual Machine action.

Check the Remote KVM box to automatically launch a KVM session with the newly created virtual machine. If launching a KVM, select a resolution from the drop down menu.

ISO Store

The ISO Store is an area dedicated to archive CD/DVD Images for use in the installation of software onto virtual machines. Once an ISO has been made available in the store, it may be mounted to any virtual machine, and booted for installation of operating systems and other software. Mounting an ISO image in this way is comparable to placing a CD/DVD into the cd rom drive of a physical machine.

The ISO Store keeps files in a preinstalled folder on the Modular Server. To view the contents, select the Storage top navigation tab. In the VM Storage Pool, select the ISOSTORE icon and launch the See Contents action from the action menu.

To move ISOs into this folder, it needs to be shared on the network. Go to the Settings > Virtualization > Cluster Share screen (“[Cluster Share Screen](#)” on [page 152](#)) to configure this folder for sharing. After the folder is shared, refer to the next section to add files to the ISO Store: “[Populating the ISO Store](#)” on [page 152](#)

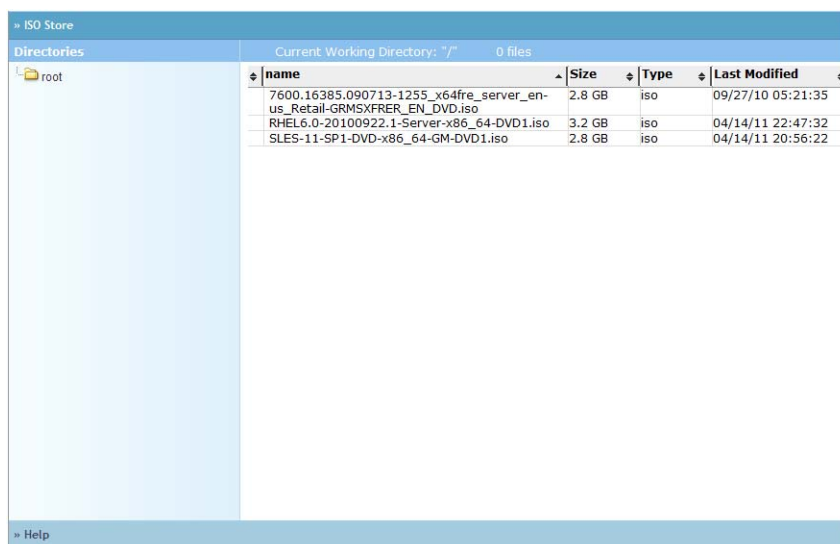

Figure 68. ISO Store Screen

Mounting an ISO from within the Create VM, or CD ROM actions

To mount a ISO image to a virtual machine:

1. Choose the target virtual machine from the icons in the VM pool. If the virtual machine doesn't exist yet, select Create VM from the action menu.

2. From within the Create VM, or Modify VM action there will be a Mount a CD or disc image: option. Select Internal ISO Store, Windows Share from the drop down menu.
3. Select the Choose ISO button next to the drop down menu. This will launch a pop up window displaying the ISO Store directory tree.
4. The contents of the folder will be displayed. Double click on the ISO to be mounted.
5. The ISO Image will now be available to the virtual machine once the action is completed.

Using the ISO Stores Global Action

When accessing the ISO Store from the Global Action menu, a user will be presented with a pop up menu with two navigation bars: ISO Store, and Help.

ISO Store:

When this bar is selected, the user will be shown a directory tree with folders. See Figure 70:

Help:

Contains instructions on the function of the ISO Store.

Installing Software on a Virtual Machine

Before installing software onto a Modular Server, these steps need to be completed:

- The Cluster Share is configured: [“Cluster Share Screen” on page 152](#)
- Software is transferred to the ISO Store: [“Populating the ISO Store” on page 152](#)
- The Software image is mounted to the Virtual Machine: [“Mounting an ISO from within the Create VM, or CD ROM actions” on page 109](#)

After these configuration steps have been completed a user installs OS software by:

1. Selecting the Virtual Machine from the VM Pool.
2. Select the Power On action.
3. Start a KVM session by clicking the Start KVM Session checkbox. Select a resolution supported by the OS installation wizard.

Note: *For the best results, choose a resolution supported by the OS running on the VM. Also, to avoid the image being truncated, use a monitor that supports the minimum OS resolution.*

Minimum Resolutions for Commonly used Operating Systems:

- Red Hat Enterprise Linux 6.1: 1024x768
 - Windows Server 2008 R2: 800x600
 - SuSE 10 & 11: 800x600
4. Select the Apply button.

5. While the VM powers on, the iso image is booted from, much like a CD Rom in a physical system. The user may now manage the installation process in the KVM session window.

Remote KVM Action

The Remote KVM feature is used to connect a remote graphical console to a virtual machine.

The Keyboard/Video/Mouse session for virtual machines are different from those of compute modules. Once connected, a pop up window allows access to the virtual machine via a simulated monitor. Along with allowing the use of the keyboard and mouse, the session has the following commands available as buttons: Disconnect, Options, Clipboard, Send Ctrl-Alt-Delete, and Refresh.

Note: *CTRL-ALT-DELETE and Refresh buttons are unavailable if the VM boots from a drive without a software image. To reboot, use the Shutdown and Power On actions.*

To start a Remote KVM to a Virtual Machine:

1. Select the Virtual Machines tab from the top navigation bar.
2. Choose the target Virtual Machine icon from the VM Pool.
3. Choose the Remote KVM action.
4. Choose a display resolution from the drop down menu.

Note: *For the best results, choose a resolution supported by the OS running on the VM. Also, to avoid the image being truncated, use a monitor that supports the minimum OS resolution.*

Minimum Resolutions for Commonly used Operating Systems:

- Red Hat Enterprise Linux 6.1: 1024x768
 - Windows Server 2008 R2: 800x600
 - SuSE 10 & 11: 800x600
5. Choose Apply.

A browser pop up menu will appear displaying the monitor output from the VM. Use the keyboard and mouse to administer the VM operating system.

Troubleshooting the KVM:

Rebooting Compute Modules:

Resource intensive activity, such as installing an OS over the KVM, may cause the compute modules to appear to spontaneously reset and reboot when they are operating normally. If this happens, it is recommended to manually check the status of the compute modules. If everything is working correctly, it is safe to continue with the installation.

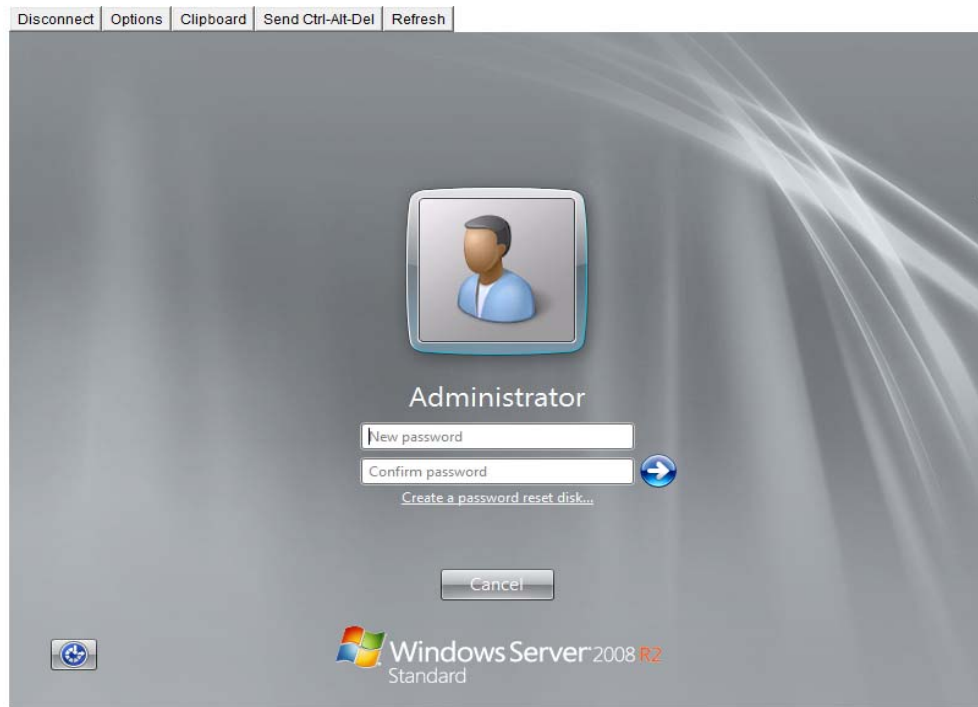

Figure 69. Remote KVM Pop Up Terminal Window

Chassis Back

The Chassis Back view provides an accurate visual view of the back of the chassis, which includes the management module, switch modules, storage control modules, power supplies and fans. This real-time view enables an IT administrator to select the component of interest, quickly view the current health, and also determine which components are present or not present. The icons present on each of the components indicate the current health. By hovering over the component icon, a brief summary of the current health, state and component description is displayed in a pop-up box.

To access the Chassis Back view, click the Chassis Back tab in the top menu. By default, no components are selected on the chassis in this view.

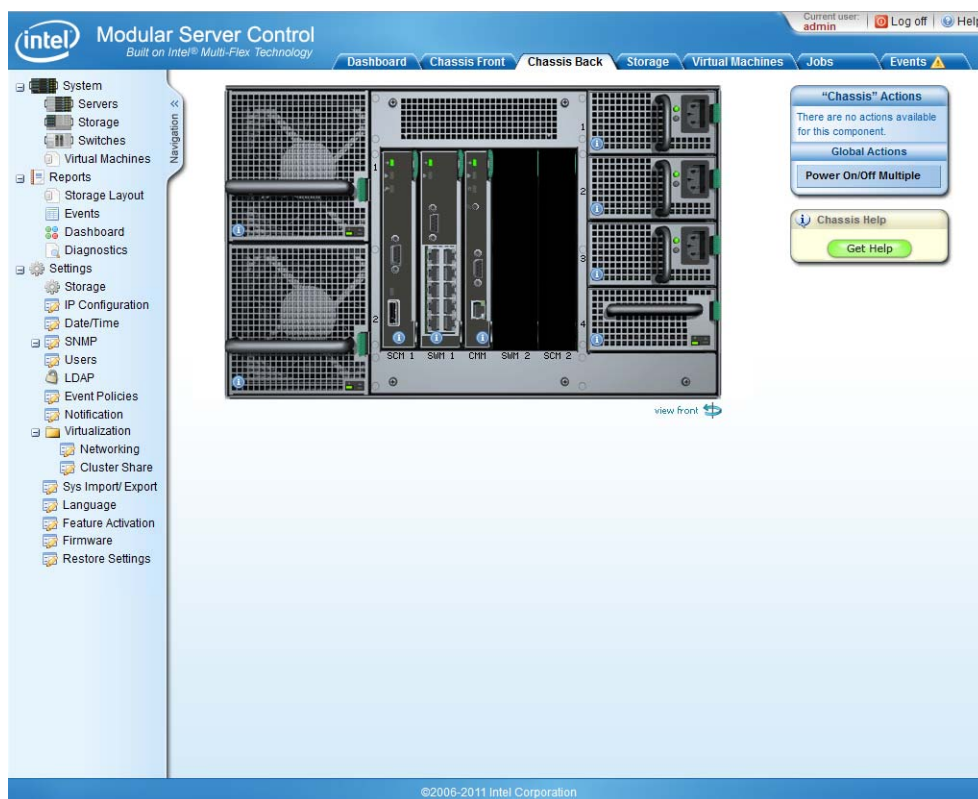

Figure 70. Chassis Back View

Intel® Storage Control Module 1 and 2

The Intel® Modular Server System MFSYS25V2 contains at least one storage module in slot SCM1. A second storage module may be added to improve performance and provide redundancy in the event one SCM fails. If there are two SCMs installed in the system, the SCMs are redundant and in the event of an SCM failure, the remaining SCM will become the primary control module for all virtual drives.

The Intel® Modular Server Control UI enables an IT administrator to grant compute modules with access to external storage via the expansion port, view health information, and view product details. To view the current status, available actions, and product details for an installed Intel® Storage Control Module, click the Chassis Back tab in the top menu to display the back of the system and select the specific storage control module from the system graphic. The content displayed on the informational tabs, action box, and help box will be updated with product-specific information and available actions for the selected storage control module highlighted in green. The current health and product summary information is quickly available by moving the mouse over the Health/Information icon located on the selected storage control module.

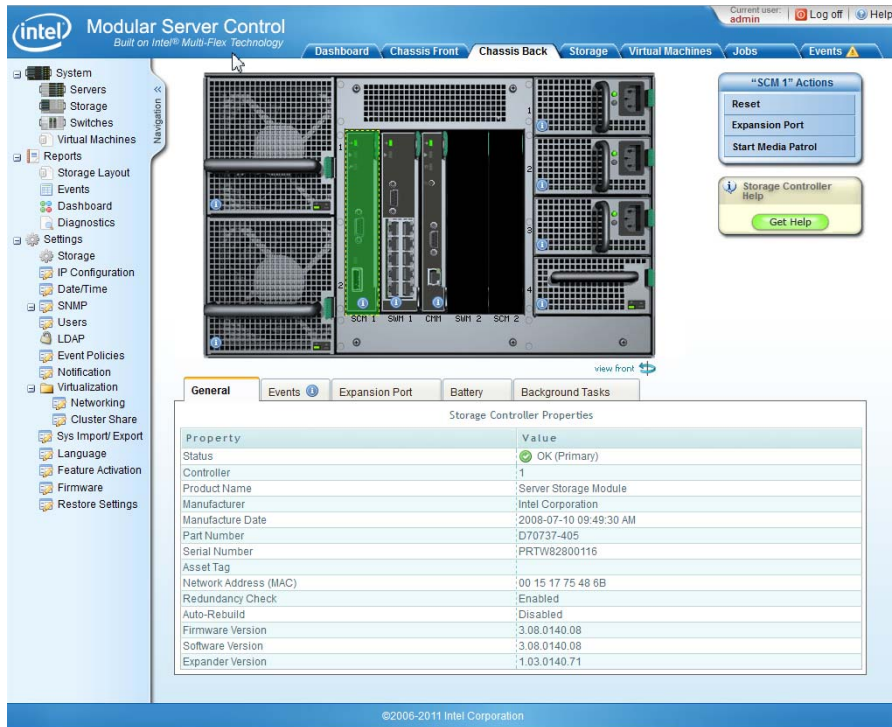







Figure 71. Intel® Storage Control Module View

Health Icons







The health icons are displayed on the graphical representation of the component when the component is selected.





Table 28. Health Icons

| Health Icon | Meaning |
|---|---|
|  | Critical (For details, see the Event Log. For information about accessing the Event Log, see “Events” on page 124.) |
|  | Warning (For details, see the Event Log. For information about accessing the Event Log, see “Events” on page 124.) |
|  | Information |
|  | OK |
|  | Firmware update or other background activity |

Status Messages

Table 29. Status Messages

| Health Icon | Status Message | Meaning |
|---|------------------------------|--|
|  | Firmware update in progress. | The SCM firmware update is in progress. |
|  | Initializing (Offline) | The SCM is initializing after a reboot. |
|  | Rebooting (Offline) | The SCM is rebooting. |
|  | Unmanageable (Offline) | The SCM is not responding to the CMM. |
|  | OK (Primary) | The SCM is operational. In a dual SCM configuration, this SCM is the primary controller. In a single SCM configuration, this SCM is the primary controller by default. |
|  | OK (Secondary) | The SCM is operational and this SCM is the secondary controller in a dual SCM configuration. The SCMs have redundancy. |

| Health Icon | Status Message | Meaning |
|---|-------------------------------------|--|
|  | OK (Primary)(Critical) | This SCM is operational, but the status is critical because redundancy has been lost in a dual SCM configuration. This SCM is now the primary controller for all virtual drives. |
|  | Status (Component Error) | The SCM is not operational due to an internal failure or a failed firmware update. |
|  | Safe Mode (Offline) | The SCM is in Safe Mode. The SCM will not process any I/O requests. |
|  | Status (Firmware Update Pending) | A firmware update is pending for this SCM. For details, see “Firmware Updates” on page 158. |

Intel® Storage Control Module Actions

The actions available for a selected storage control module are displayed to the right of the system graphic. For a description of these actions, refer to the following table.

Table 30. Storage Control Module Action Menu

| Action Menu Item | Description |
|------------------|---|
| Reset | Enables remote reset of the selected Intel® Storage Control Module. |
| Expansion Port | Enable/Disable server access to the external expansion port on the selected storage control module. Additional external storage options are available to the server via the expansion port. |

Intel® Storage Control Module Details

The tabs displayed below the system graphic provide detailed information for the selected storage control module. For a description of these tabs, refer to the following table.

Table 31. Storage Control Module Tabs

| Tab Heading | Description |
|---|--|
| General | The General tab displays: <ul style="list-style-type: none">• Current status of the selected storage control module (i.e., status, health, boot state, master state, battery state)• Product data information, including manufacturer, firmware revision, serial number, product ID, etc. |
| Events | Displays all events for the selected Intel® Storage Control Module. |
| Expansion Port | Displays the expansion port access table. |
| Battery | Displays the battery property table, which includes battery status, temperature, remaining capacity percentage, cycle count, voltage, current, cell type, estimated hold time, etc. |
| Background Tasks (displayed if an action is occurring on a virtual drive) | Lists any Active Tasks currently involving the virtual drive, such as creating, expanding, rebuilding, or migration. |

Intel® Storage Control Module Help

To quickly access additional help regarding the Intel® Storage Control Module screen, actions, and tabs, click on the Get Help button in the Storage Control Module help box located under the actions box.

Intel® Management Module

The Intel® Management Module, installed in the middle bay (labeled CMM) of the rear of the system, provides the Intel® Modular Server Control UI that is used to configure and manage the modular server system hardware. This module is not redundant, but the system will continue to operate normally should this module fail. However, configuration changes cannot be made until a failed Intel® Management Module is replaced.

The Intel® Modular Server Control UI enables an IT Administrator to reset the Intel® Management Module, view health information, and view product details. To view current status, available actions, and product details for the installed Intel® Management Module, click the Chassis Back tab in the top menu to display the back of the system and select the management module from the system graphic. The content displayed on the informational tabs, action box, and help box will be updated with product-specific information and available actions for the management module highlighted in green. The current health and product summary information is quickly available by moving the mouse over the Health/Information icon located on the management module graphic.

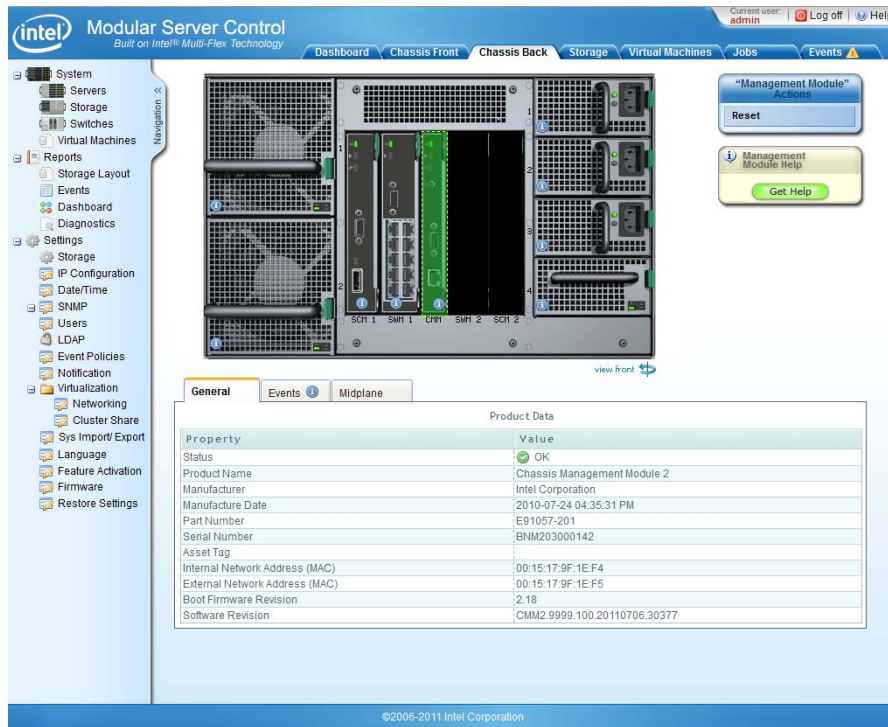





Figure 72. Intel® Management Module View

Health Icons

The health icons are displayed on the graphical representation of the component when the component is selected.

Table 32. Health Icons

| Health Icon | Meaning |
|---|---|
|  | Critical (For details, see the Event Log. For information about accessing the Event Log, see “Events” on page 124.) |
|  | Warning (For details, see the Event Log. For information about accessing the Event Log, see “Events” on page 124.) |
|  | Information |
|  | OK |

Intel® Management Module Actions

The actions available for a selected management module are displayed to the right of the system graphic. For a description of these actions, refer to the following table.

Table 33. Management Module Action Menu

| Action Menu Item | Description |
|------------------|---|
| Reset | Enables remote reset of the selected management module. |

Intel® Management Module Details

The tabs displayed below the system graphic provide detailed information for the management module. For a description of these tabs, refer to the following table.

Table 34. Management Module Tabs

| Tab Heading | Description |
|-------------|---|
| General | The General tab displays: <ul style="list-style-type: none">• Current status of the selected management module• Product data information, including manufacturer, firmware revision, serial number, product ID, etc. |
| Events | Displays all events for the selected Intel® Management Module. |
| Midplane | Displays product data information for the midplane, including manufacturer, firmware revision, serial number, part number, etc. |

Intel® Management Module Help

To quickly access additional help regarding the Intel® Management Module screen, actions, and tabs, click on the Get Help button in the Management Module help box located under the actions box.

Intel® Modular Server Fans and Power Supplies

Fans and power supplies are available for selection and viewing from the system graphic.

The system has three fan modules:

- One I/O cooling module (front panel)
- Two server cooling modules (rear panel)
- Each power supply also has integrated cooling fans.

The system can have up to four power supplies that are accessed from the rear panel. Each power supply also has integrated cooling fans. If a power supply is not installed, a fan blank panel must be installed in the power supply slot to ensure proper cooling.





To view current status, available actions, and product details for all installed fans and power supplies, select the specific component from the system graphic. Once selected, the main screen graphic will change to display the selected fan or power supply highlighted in green. The help box and informational tabs will update to provide all available information for the selected fan or power supply. Current health and product summary is quickly available by moving the mouse over the Health/Information icon located on the selected component.

Note: *No actions are available for fans or power supplies.*

Health Icons

The health icons are displayed on the graphical representation of the component when the component is selected.

Table 35. Health Icons

| Health Icon | Meaning |
|---|---|
|  | Critical (For details, see the Event Log. For information about accessing the Event Log, see “Events” on page 124.) |
|  | Warning (For details, see the Event Log. For information about accessing the Event Log, see “Events” on page 124.) |
|  | Information |
|  | OK |

Intel® Modular Server Fans and Power Supplies Details

The tabs displayed below the system graphic provide detailed information for the selected fan or power supply. For a description of these tabs, refer to the following table.

Table 36. Fans and Power Supplies Tabs

| Tab Heading | Description |
|-------------|--|
| General | The General tab displays: <ul style="list-style-type: none">• Current status of the selected fan or power supply (i.e., status, health)• Product data table will display information, including manufacturer, model number, serial number, etc. |
| Events | Displays all events for the selected fan or power supply. |
| Sensors | Displays current sensor information, including fan speed, input/output power, temperature, etc. |

Reports

The Intel® Modular Server Control generates several standard reports. These reports are used by IT administrators to view overall system health, system configuration information, event logs, diagnostic information, storage resource allocation map, switch performance, and hardware and firmware inventory. The following reports are supported: Storage Layout, Events, Dashboard, and Diagnostics.

Storage Layout

The Storage Layout report shows a graphical or tabular representation of all the components in the storage subsystem. This report shows you:

- Physical drives and drive groups (physical drives assigned to a storage pool)
- Storage pools with the assigned hot-spare drives
- Virtual drives showing the drive name, storage capacity, and RAID level
- The drive mappings to the servers showing the drive numbers for each drive on the server
- The storage control module affinity for each virtual drive.

To access the Storage Layout report, click Reports > Storage Layout in the left navigation panel.

You can switch between the graphical and table views by clicking on the link at the top of the report.

Note: *The Physical drives and Server columns represent the physical slots for hard drives and servers. If a drive is not present, it will be marked as not present.*

The Storage Layout graphics in [Figure 73](#) and [Figure 74](#) illustrate both the graphical and tabular views for the following storage configuration:

- Fourteen physical drives present in the system.
- Drives 1, 2, and 3 are grouped together in a single storage pool named “Storage Pool 1”.
- Drive 14 is a global hot spare.
- Drives 4 - 13 are available/unused.
- One storage pool is present. The storage pool is named “Storage Pool 1” and is 100.58 GB in size.
- Two virtual drives are present. One virtual drive is named “Finance” and is configured as a 25-GB RAID 0 drive. The second virtual drive is named “Marketing” and is configured as a 30-GB RAID 0 drive.
- The virtual drive “Finance” is assigned to Server 1 as Drive 0. The virtual drive “Marketing” is assigned to Server 2 as Drive 0.

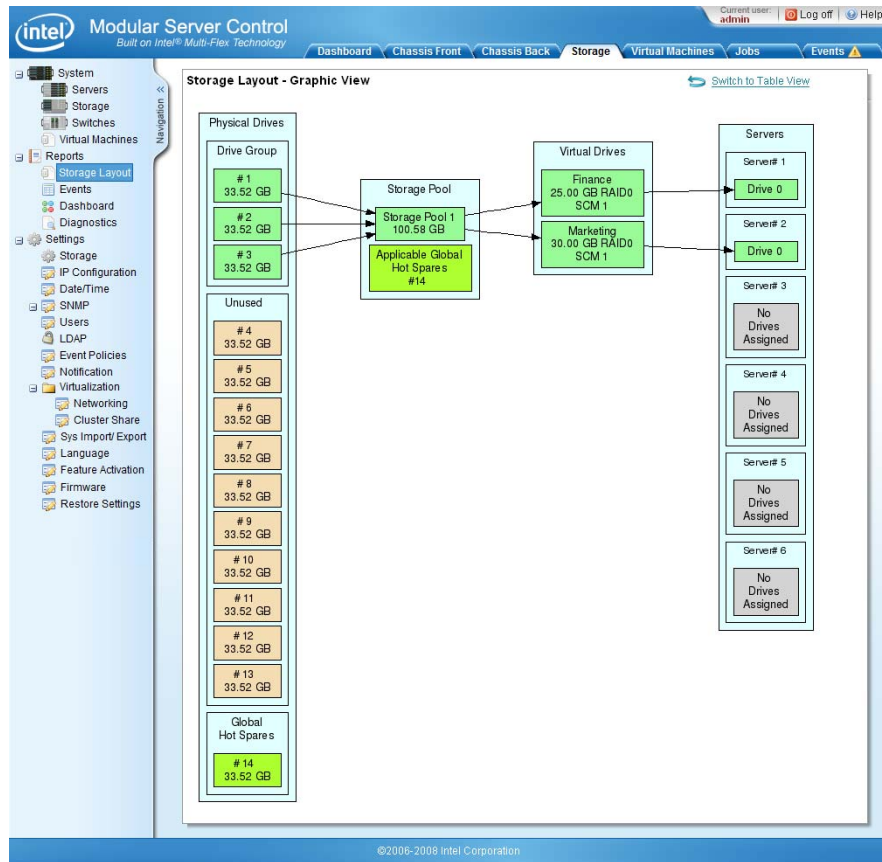

Figure 73. Storage Layout Graphical View

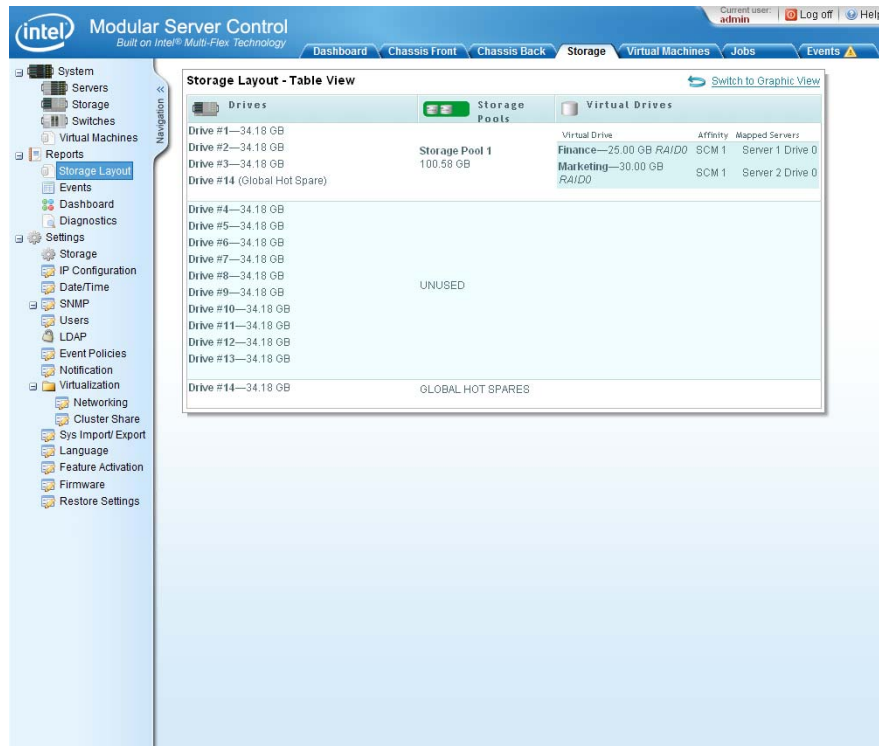

Figure 74. Storage Layout Tabular View

Events

The Events screen contains a table of all open and unacknowledged system events. This screen enables an IT administrator to quickly view and acknowledge new events for all system components in a single location.

To access the Events screen, click the Events tab in the top menu or click Reports > Events in the left navigation panel.

The following features enable the IT administrator to quickly access specific information from the System Event Log screen:

- Sort events: Sort the events in the table by ID, Date/Time, Component Type, Description, Severity, and User by clicking on the appropriate column header.
- View filter: Filter events by Active, Closed, or All events.
- Severity filter: Filter events by Info +, Warning +, or Critical Severities.
- Close events: Close individual events by selecting the checkbox next to the event and clicking the Close Selected button. Once an event is closed, it is no longer displayed on this screen.
- Delete All events: Delete all events in the log by selecting the Delete All button.
- View event details: Click on the + sign to the left of the specific event row to display further details about the event, as shown in Figure 75. Clicking on the Policy ID

number opens the Event Policy Definition dialog as shown in Figure 76. The Event Policy actions can be modified in this window.

- **XML:** Download the system event information in XML format. This will download all unacknowledged events, not just the default 20 events displayed on the events screen.
- **CSV:** Download the system event information in CSV format. This will download all unacknowledged events, not just the default 20 events displayed on the events screen.
- **View Component screen:** Click on the component link in the specific event row to be redirected to the component screen to view available actions and additional information to resolve or troubleshoot the issue.
- **Rows per screen:** IT administrators can customize the event view by indicating how many rows (between 10 and 50, in increments of 5) that they would like displayed on each screen.
- **Navigate events:** If more than 20 events are present, links to additional pages is displayed at the top of the screen next to the Rows drop-down list. Click on the page number to view additional events.

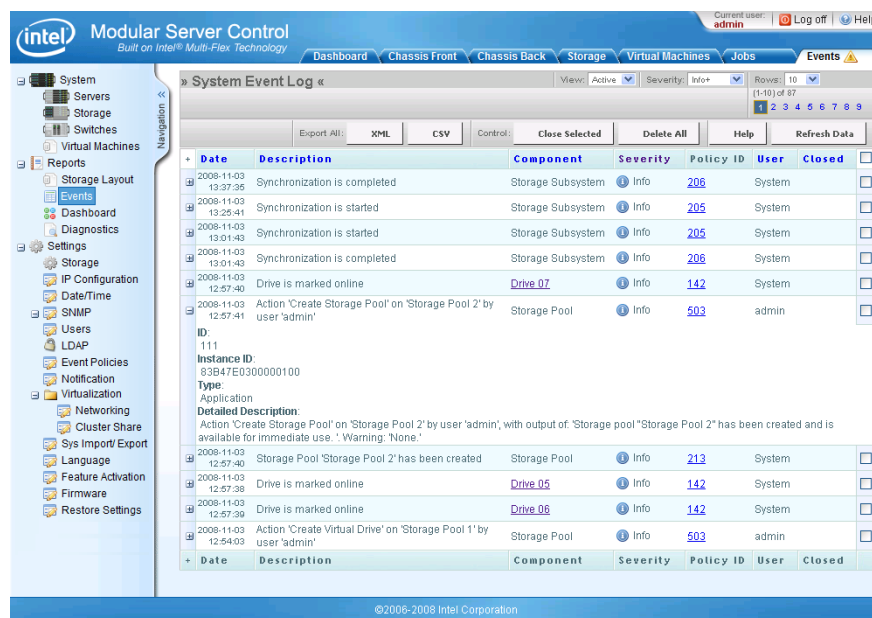

Figure 75. System Event Log Screen

Note: To view a history of events, select the event tab on each component screen.

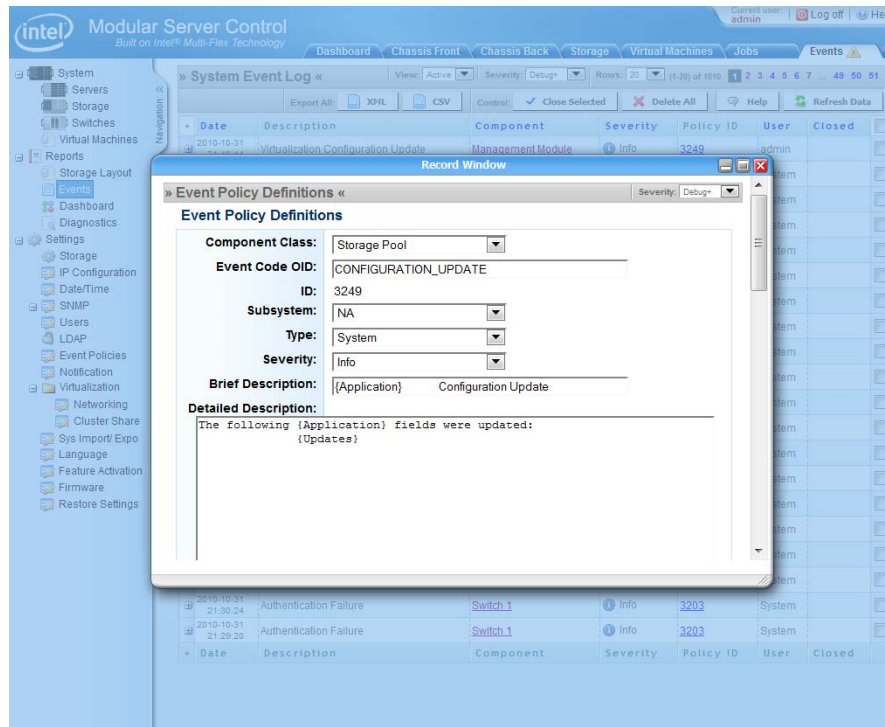

Figure 76. Event Policy Record Window

Dashboard

The Dashboard view provides an interactive snapshot of the overall system and component health, as well as a list of all required actions and critical events. To get detailed information about any component presented on the dashboard, move the mouse over the component or icon to view summary information, or click the component to be redirected to the component screen.

To access the Dashboard view, click the Dashboard tab in the top menu or click Reports > Dashboard in the left navigation panel. This view is displayed by default after successfully logging into the Intel® Modular Server Control UI.

The Dashboard consists of the following five main areas:

- **Required Actions:** The required actions box includes, but is not limited to, initial system configuration steps, steps to replace a failed component, or steps to resolve a system error. The actions are listed as links that direct the IT administrator to the appropriate screen to complete the required action.
- **System Health:** The system health box lists all possible system components with a visual health icon indicator. Moving the mouse over either the component name or health icon will display summary information, including whether the component is present or not present in the system, its current health and a component description. To view detailed information and available actions for any component, click the component name to be redirected to the specific component configuration screen.

- **Power Load:** Quickly enables the IT administrator to view the current power consumption of the system. If the arrows are in the green area of the indicator bar, power redundancy is enabled. The yellow area of the indicator bar shows non-redundant power. The red area indicates a critical state.
- **Temperature:** Displays the current system temperature.
- **Recent Critical Events:** Displays all recent (unacknowledged) critical events and a link to View All Events. The View All Events link redirects the IT administrator to the Events view.

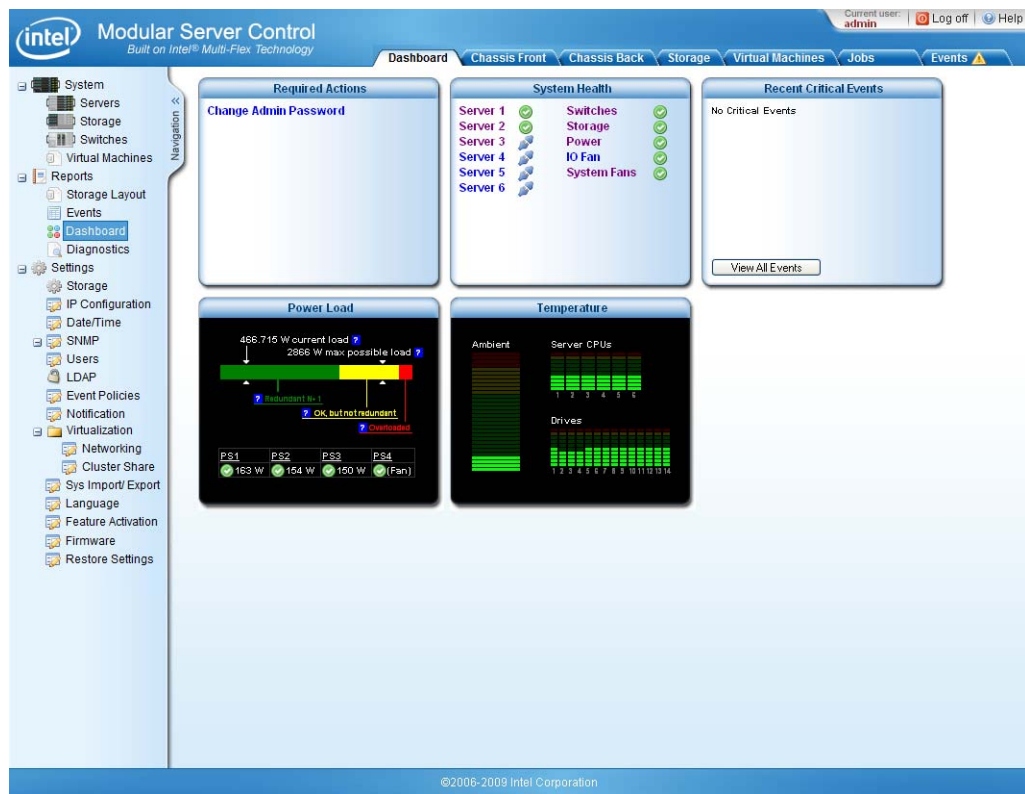

Figure 77. Dashboard View

Diagnostics

The Diagnostics screen enables an IT administrator to obtain information about recent events generated by the servers, chassis, and storage components, and to run tests to diagnose the internal state of the system. This screen is not meant to be used as a general purpose information screen, but only as a source of information that can be provided to support personnel for problem resolution.

To access the Diagnostics screen, click Reports > Diagnostics in the left navigation panel.

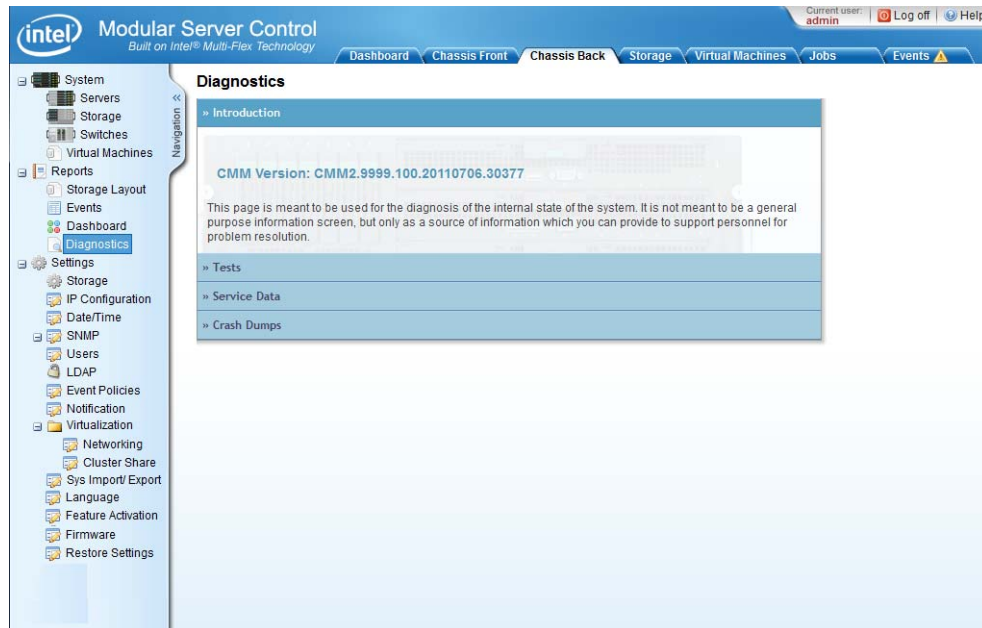

Figure 78. Diagnostics

Tests

The Internal Communications Test and System Information Report can be found in the test portion of the Diagnostics screen.

The Internal Communications Test verifies that each component can communicate with the management module. Clicking on the Internal Communications Test will open the results within the Record Window. The Record Window will display all present devices as well as pass/fail information from the test. The Internal Communications Test will test communications for every installed Ethernet switch module, storage control module, fan, chassis, and server.

The System Information Report generates a complete report about your system and the system settings (this does not include user account information). Clicking the System Information Report will download the service information, which can be saved or opened as shown in [Figure 80](#) and [Figure 81](#).

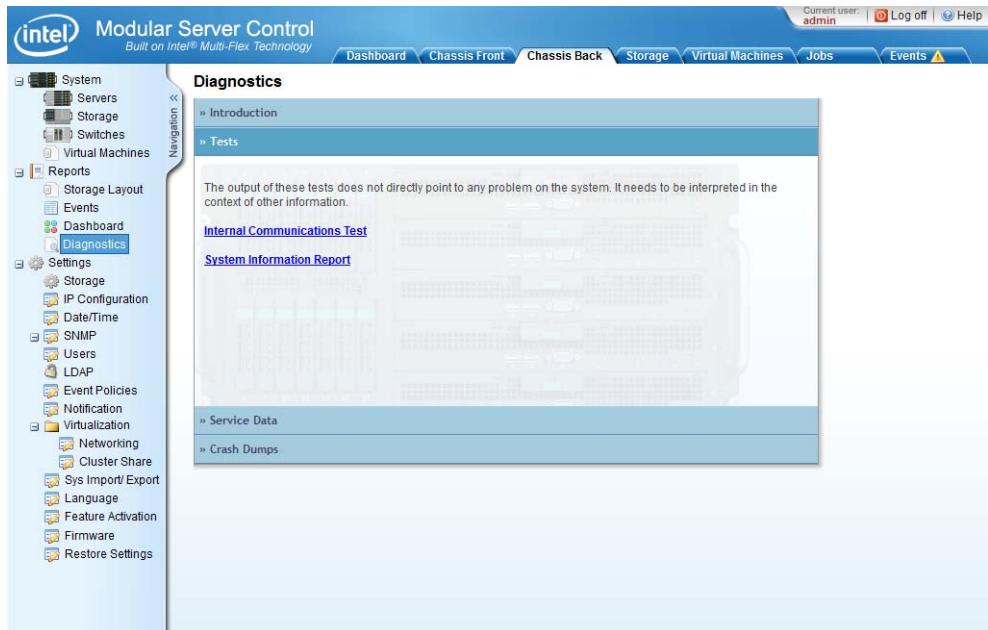

Figure 79. Diagnostic Tests

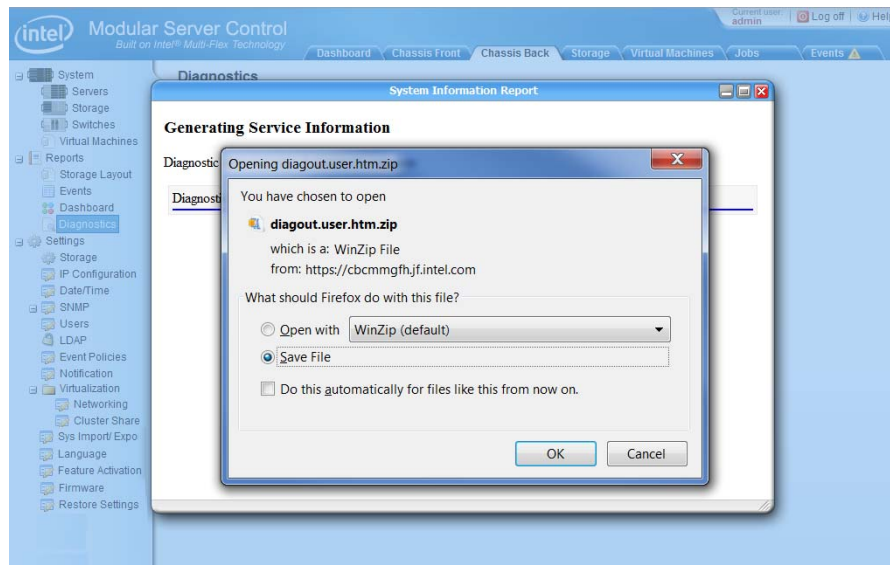

Figure 80. System Information Report Download

DIAGNOSTIC INFORMATION

Test run: 11/18/2008 16:30:03

- [Event Log Table](#)
- [ID ROM Data](#)
- [SD Card Utilization](#)
- [Dashboard](#)
- [Firmware](#)
- [All Component Status](#)
- [Component Data - Servers](#)
- [Component Data - Switches](#)
- [Component Data - Storage Controllers](#)
- [Component Data - Management Module \(CMM\)](#)
- [Component Data - Fans](#)
- [Component Data - Power Supplies](#)
- [Storage - Layout](#)
- [Storage - Physical Drives](#)
- [Storage - Virtual Drives](#)
- [Storage - Pools](#)
- [Configuration - IP Configuration](#)
- [Configuration - Notification](#)
- [Configuration - SNMP](#)
- [Configuration - Date/Time](#)

Event Log

| Event LogId | Date | EventPolicyId | ComponentId | InstanceId | EventSeverityId | EventTypeId | DetailedDescription | EventCause | EventAction | BriefDesc |
|-------------|---------------------|------------------------------------|-------------|------------|-----------------|-------------|---|--------------------------------|-----------------------|---------------------------|
| 3 | 2008-11-07 10:38:41 | Attention State - Identify LED off | Server 1 | | Info | IPMI | Sensor: Attention State - Identify LED off. | Server Sensor: Attention State | No action is required | Attention State - LED off |
| 4 | 2008-11-07 10:38:43 | Attention State - Identify LED off | Server 2 | | Info | IPMI | Sensor: Attention State - Identify LED off. | Server Sensor: Attention State | No action is required | Attention State - LED off |
| 5 | 2008-11-07 10:38:44 | Attention State - Identify LED off | Server 3 | | Info | IPMI | Sensor: Attention State - Identify LED off. | Server Sensor: Attention | No action is required | Attention State - LED off |

Figure 81. System Information Report

Service Data

The Service Data window provides the IT administrator with the ability to collect information about the storage subsystem, gigabit switches, or the entire system. This information should be provided to a service technician to troubleshoot any issues with the system. The test report is encrypted and can only be unlocked by a service technician. The test report does not contain user account information.

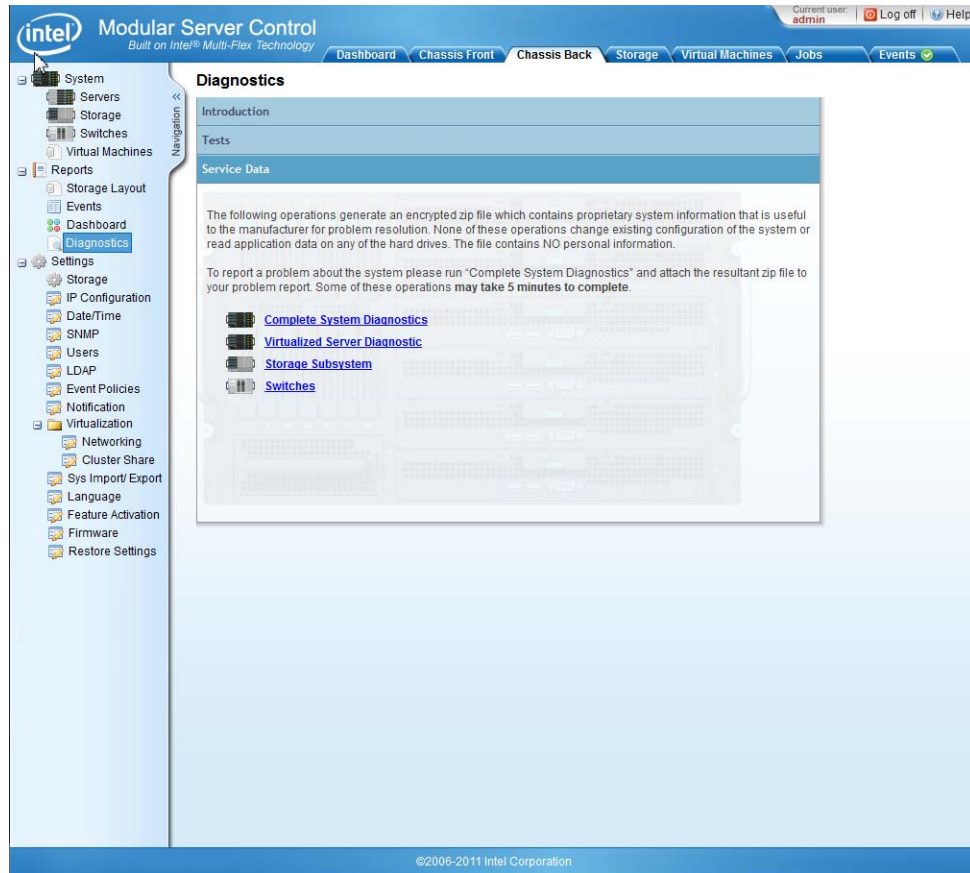

Figure 82. Diagnostics - Service Data

Settings

To access the general configuration settings, click Settings in the left navigation panel. These screens enable an IT administrator to modify and view general system settings for maintenance and hardware management.

Storage Options

Drive Caching Options

Every physical hard drive in the chassis has an on-board cache. The cache generally improves the I/O performance of a drive by acting as a fast data buffer during large read and write operations.

This is a chassis-wide setting, that is, all drive write-back caches are either enabled or all are disabled.

Drive write-back cache is disabled by default because there are some risks involved. In the case of a sudden power loss to the chassis, all hard drives would immediately power off. If there were data in a cache waiting to be written to the drive, it would be lost and unrecoverable. To avoid this situation, provide a power backup (such as an UPS) for the chassis. The backup power supply should be capable of and configured to trigger an orderly shutdown of each server in the chassis.

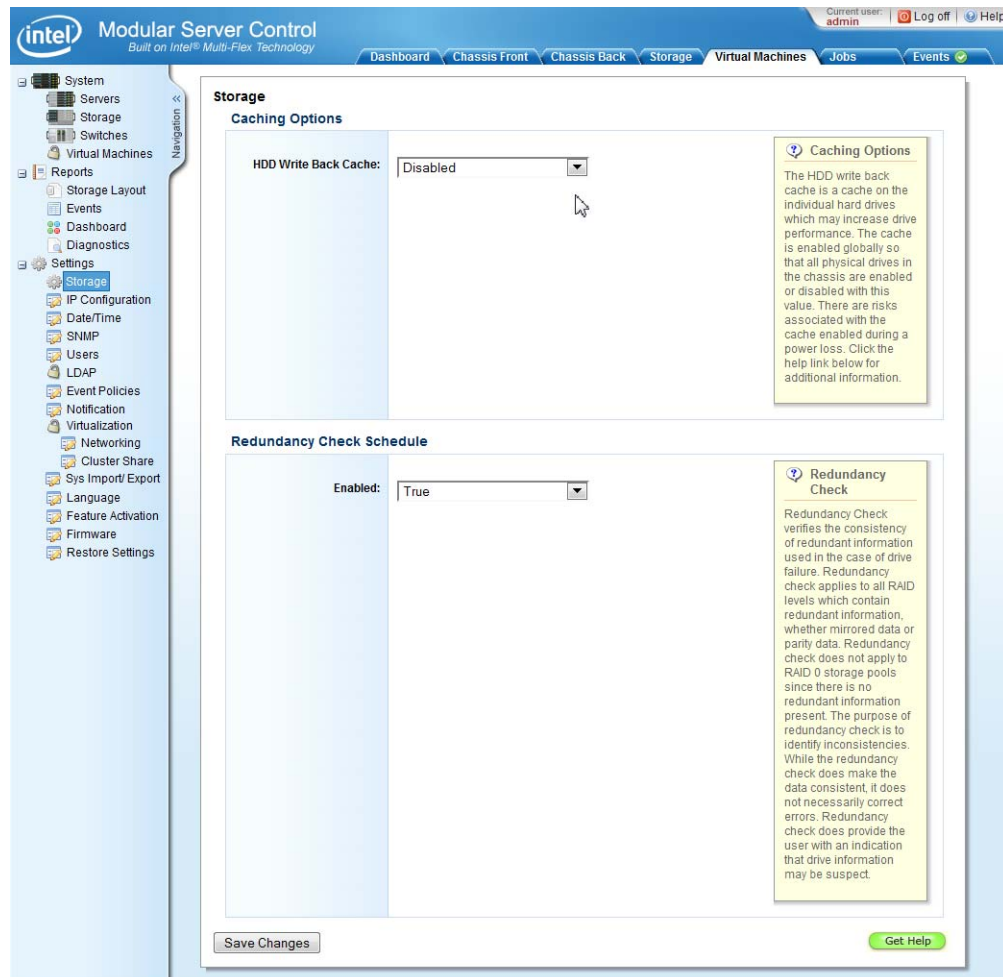

Figure 83. Settings - Storage Options Configuration

Storage Redundancy Check Options

The purpose of redundancy check is to identify inconsistencies. While the redundancy check does make the data consistent, it does not necessarily correct errors. Redundancy check does provide the user with an indication that drive information may be suspect.

The customer can Enable or Disable Redundancy Check schedule by themselves.

IP Configuration

The Intel[®] Management Module has two Gigabit Ethernet connections to each Gigabit Ethernet Switch. These internal connections allow the management module to communicate to the switch module and the external network. The external IP address allows remote browsers to connect to the Intel[®] Modular Server Control UI and sets the source IP address for email alerts and SNMP traps.

The factory default IP address is 192.168.150.150. The default netmask is 255.255.255.0.

The IP Configuration screen enables an IT Administrator to change the Intel® Management Module host name and external network access, as well as view the internal configuration. The following is a description of the settings and information found in the IP Configuration tab:

- **Host Name:** Change the management module host name.
- **MAC Address:** Displays the MAC address for the management module.
- **Method:** Choose between static-Address or Automatic-DHCP. The initial management module IP address is set to the static IP address of 192.168.150.150. This IP address may be set to DHCP or a different IP address to enable access within an existing network environment.
- **External IP configuration settings:** IP address, netmask, gateway IP, DNS 1 (Enter Domain Name Server IP Address, if applicable), DNS 2 (Alternate Domain Name Server)
- **Internal IP configuration information** for the management module is displayed as read only.

To access the IP Configuration screen, click Settings > IP Configuration in the left navigation panel. The Intel® Modular Server Control IP Configuration screen similar to the following image is displayed.

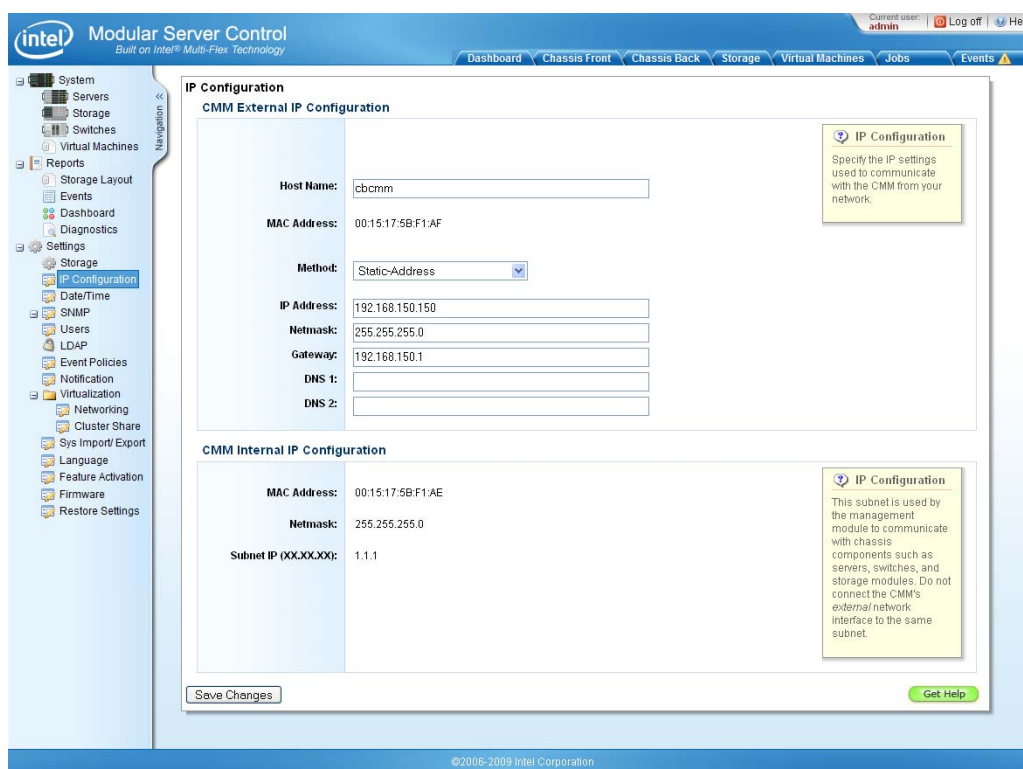

Figure 84. Settings - IP Configuration

Date and Time

The Date and Time setting enables an IT administrator to directly set the date and time or specify a network time server to set the date and time on the management module. The new date and time will be displayed once the management module is reset.

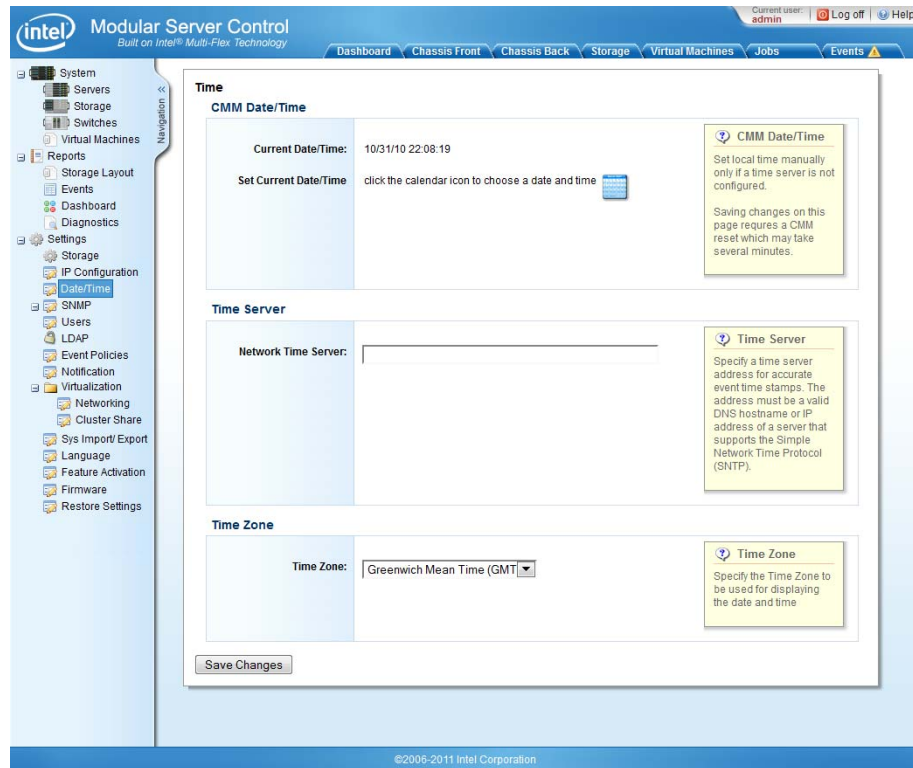

Figure 85. Settings - System Date and Time Configuration

Steps to Manually Update the Modular Server System Date and Time

Note: Use the manual setting only if the network time server is not configured.

1. Click Settings > Date/Time in the left navigation panel.
2. Click the Calendar icon and follow the instructions in the bottom pane of the calendar.



Figure 86. Calendar

3. To change the date, click the buttons beneath the printed month to change the Year and Month.
 - Click the single right angle bracket (>) to increment to the next Month; click the single left angle bracket (<) to decrement to the previous Month.
 - Click the double right angle bracket (>>) to increment to the next Year; click the double left angle bracket (<<) to decrement to the previous Year.
4. To change the time, click the values in the Hour, Minute and AM/PM box next to Time as follows:
 - To increment the Hour value, click the Hour value or drag the mouse to the right.
 - To decrement the Hour value, hold the <Shift> key and click the Hour value or drag the mouse to the left.
 - To increment the Minute value, click the Minute value or drag the mouse to the right.
 - To decrement the Minute value, either hold the <Shift> key and click the Minute value or drag the mouse to the left.
 - Click am/pm to set the time in am or pm, as required. The button toggles between the two options.
5. Click Save Changes.

In the Update dialogue box **Update** and **Reboot**. This action will reset the management module to enable the changes to take effect.

Steps to Add a Network Time Server

1. Click Settings > Date/Time in the left navigation panel.
2. Enter the IP address or DNS hostname for the network time server.

3. Click Save Changes.

In the Update dialogue box **Update** and **Reboot**. This action will reset the management module to enable the changes to take effect.

Steps to change the Time Zone

1. Click Settings > Date/Time in the left navigation panel.
2. Select the Time Zone to be used for displaying the date and time.
3. Click Save Changes.

In the Update dialogue box **Update** and **Reboot**. This action will reset the management module to enable the changes to take effect.

Simple Network Management Protocol (SNMP)

The Intel® Modular Server System MFSYS25V2 supports Simple Network Management Protocol (SNMP). An IT administrator can view system configuration settings and health information using either SNMP v2 or SNMP v3. However, an IT administrator cannot configure the Intel® Modular Server via SNMP. Full hardware management and configuration is supported via the Intel® Modular Server Control interface. For more information regarding SNMP v2 and SNMP v3 support for the installed Unified Firmware Update (UFU) release, refer to the *Unified Firmware Update (UFU) Release Notes*.

SNMP Options

The Simple Network Management Protocol (SNMP) settings allow external SNMP management applications to communicate with the SNMP agent on the Management Module. The SNMP Options must be configured in order to use SNMP v2, SNMP v3, or both SNMP v2 and SNMP v3.

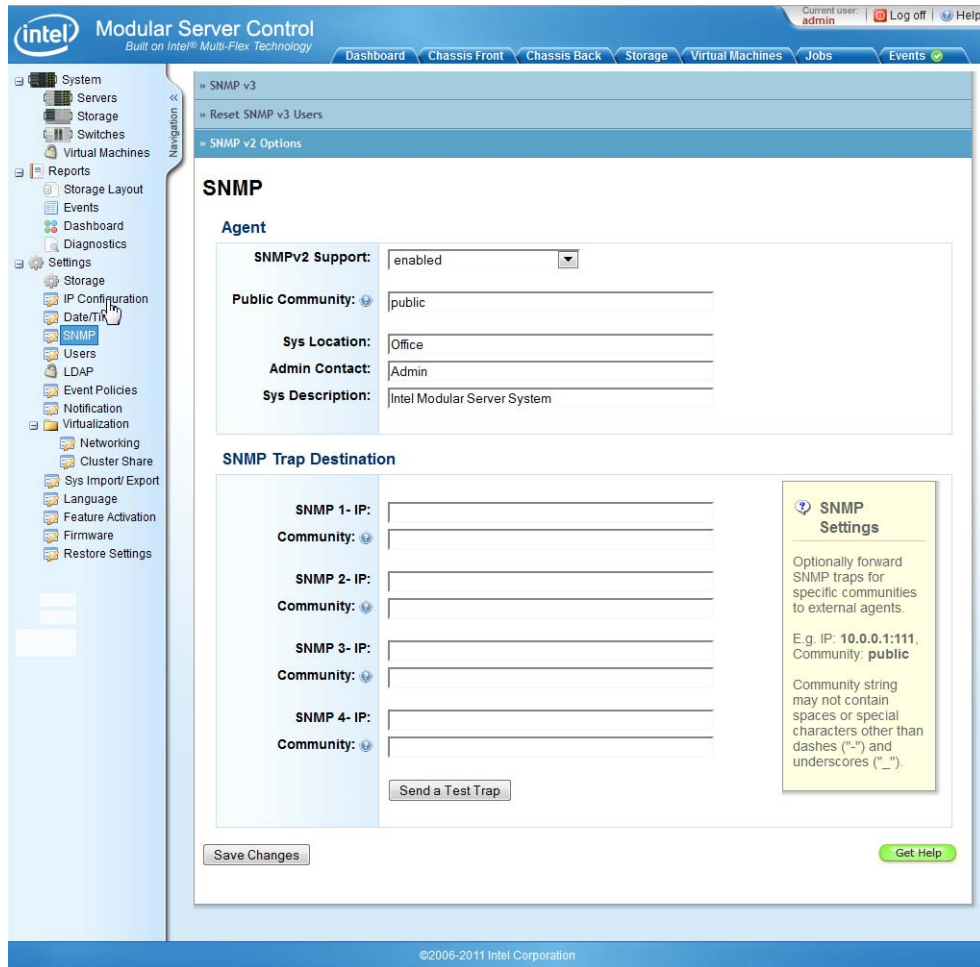

Figure 87. SNMP Options

Agent

The first option on the screen in the Agent section is to enable or disable SNMP v2. By default, this setting is set to enabled. The Intel[®] Modular Server System supports read-only access to system information via SNMP v2. To use SNMP v3, SNMP v2 does not need to be enabled; however, before changing this setting, you must verify that your management software does not require SNMP v2 access.

The Public Community string entered in the Agent section must match the community string on the remote management console.

SNMP Trap Destination

The SNMP Trap Destination section enables an IT administrator to send traps/events to four separate remote management applications. If Event Policies are configured to send SNMP Traps, you must set the SNMP Trap Destination settings for at least one destination.

To configure the SNMP Trap destination, enter the IP address and Community string for each destination. By default, SNMP uses port 162. To specify a different port in the destination IP setting, enter the IP address followed by a colon (:) followed by the port number (for example, 10.7.155.62:162).

To verify the SNMP trap destination settings, click the Send a Test Trap button and verify that the trap was received by the target system.

SNMP V3

SNMP v3 adds additional authentication and privacy features to SNMP v2. The Authentication feature provides a means to verify users or agents and the privacy feature provides a way to encrypt the data to prevent unauthorized disclosure.

The SNMP v3 Access screen enables the IT administrator to configure an SNMP v3 user account with these additional authentication and privacy features. However, to use SNMP v3, you must also configure the SNMP v2 settings on the SNMP Options screen.

Note: You do not need to enable the SNMP v2 Support option in order to use the SNMP v3 features.

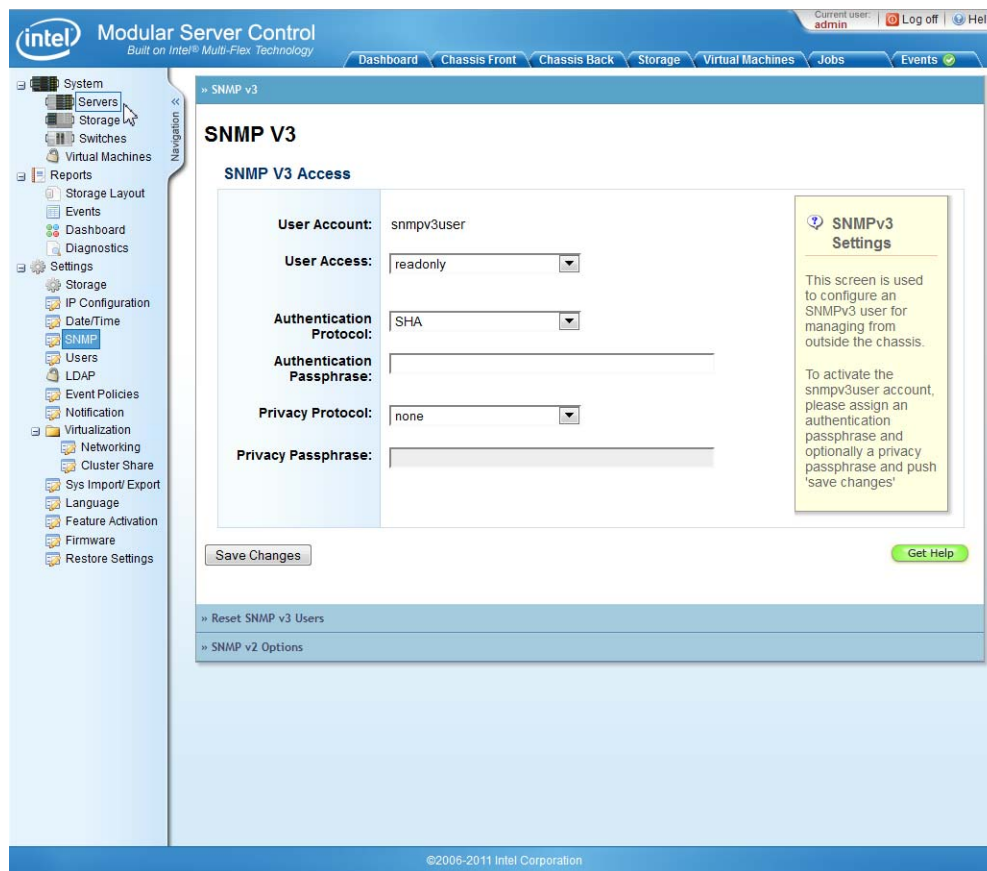

Figure 88. SNMP V3

To configure an SNMP v3 user account on the SNMP v3 Access screen, you must first set User Access to either read-only or read-write. With read-only access, an SNMP v3 user account can view system settings remotely. With read-write access, an SNMP v3 user account can view system settings remotely and change the Intel® Compute Module's power state (on/off) and identify LED (on/off). Read/write access does not enable an SNMP v3 user account to remotely configure the Intel® Modular Server System. Full hardware management and configuration is only supported via the Intel® Modular Server Control interface.

Note: For more information regarding SNMP v3 support for the installed Unified Firmware Update (UFU), refer to the Unified Firmware Update (UFU) Release Notes .

To activate the SNMP v3 user account, configure the authentication and privacy settings on this screen. First, select the authentication protocol and set the Authentication passphrase. The authentication protocol is used by the management console to authenticate the user account. Select either Secure Hash Algorithm (SHA) or Message-

Digest Algorithm 5 (MD5). By default, SHA is selected. Next, select the Privacy protocol and assign the privacy passphrase. The privacy protocol is used to encrypt the SNMP data. Select either DES, AES, or none. By default, none is selected.

Reset SNMP V3

The Reset SNMP v3 screen enables an IT administrator to delete all SNMP v3 users and recreate all internal-chassis management users. Use this procedure if an outside SNMP tool has modified or deleted the internal-chassis management users. This procedure may take up to a minute to complete. To reactivate the SNMP v3, go to the SNMP v3 settings screen.

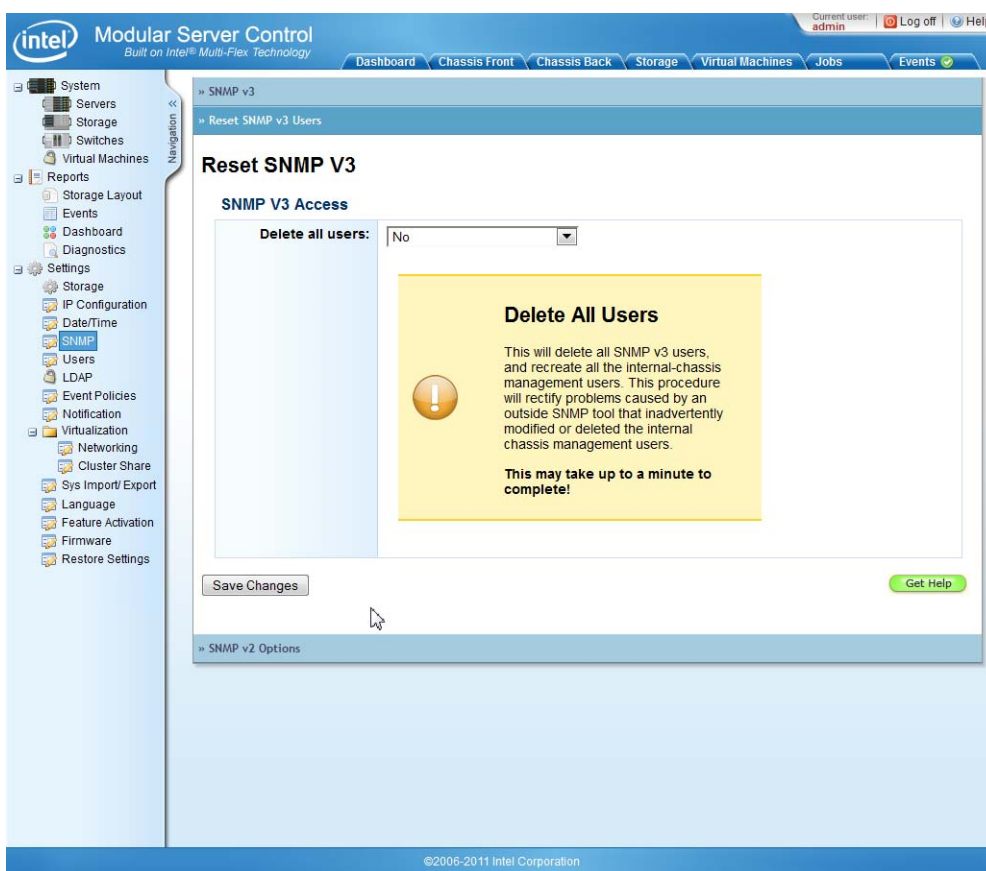

Figure 89. Reset SNMP v3

User Accounts

The Intel® Modular Server Control UI supports both administrator and user accounts. To create a new account or modify an existing account click Settings then User Accounts in the left navigation menu. An administrator account is enabled by default to allow the IT administrator to access the Intel® Modular Server Control UI for initial configuration. It is recommended that the default administrator password is changed before adding the Intel® Modular Server System to the production network. The administrator password supports a maximum of 10 characters. Supported characters are limited to letters, numbers and the following special characters ! @ # \$ ^ & * + - = _ . ?. User Account passwords do not have these restrictions. For more information regarding default login accounts, see Section , “Log in to the Intel® Modular Server Control” on page -50.

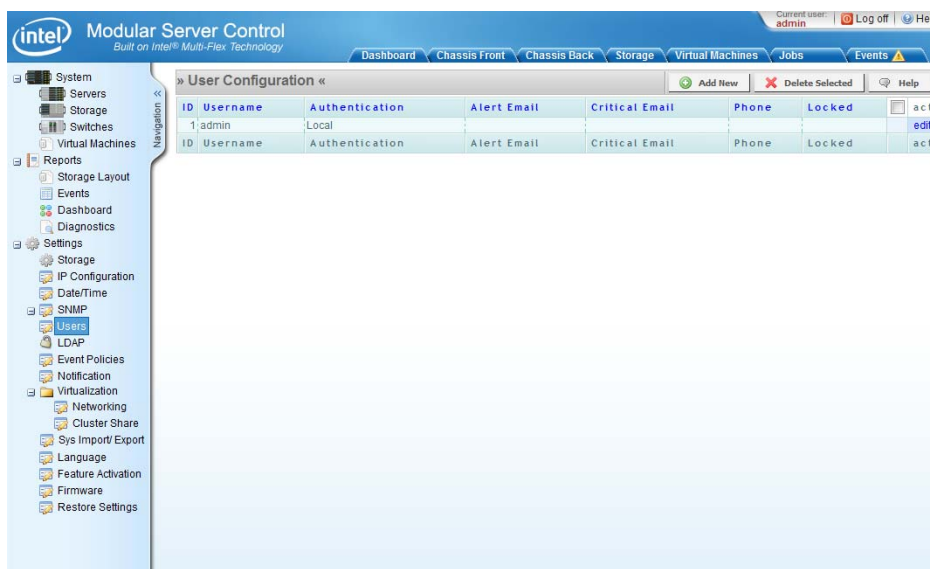

Figure 90. Settings - User Account Configuration Screen

LDAP

The CMM supports two user authentication methods: Local and LDAP. Users configured to use the Local method are authenticated using a password stored on the Modular Server chassis. LDAP refers to the Local Directory Access Protocol. When the LDAP method is used, users are authenticated with an LDAP server connected to the CMM's management interface over a TCP/IP network. The LDAP Configuration screen includes the necessary addresses and parameters to identify and communicate with an LDAP server on your network.

To test the current configuration, click the “Test LDAP” button where you will be prompted for a user name and password. The user must be a valid CMM user added through the Users Settings page.

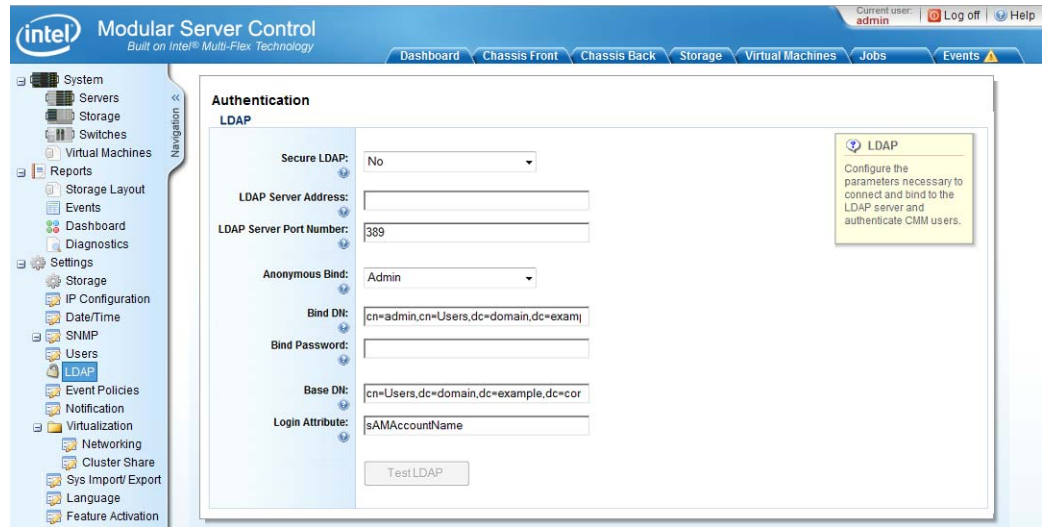

Figure 91. LDAP Authentication Configuration

Event Policies

The Event Policy screen enables the IT administrator to configure event severity and notification process. To configure an event policy, click Edit for a specific event. The Edit dialog box appears. Use the dialog box to change the severity of a specific event, as well as to select who to notify when the event occurs.

intel Modular Server Control
 Built on Intel® Multi-Flex Technology

Current user: admin Log off Help

Dashboard Chassis Front Chassis Back Storage Virtual Machines Jobs Events

Event Policy Definitions

Severity: Debug+ Rows: 20 (1-20) of 902 1 2 3 4 5 6 7 ... 44 45 46

Dev: Add New Delete Selected Toggle notification for selected: Log Email SNMP Syslog Export All: XML CSV

| Component Class | Event Code OID | ID | Subsys | Type | Severity | Brief Description | Log Every | Log | Email | SNMP | SyLg | act |
|-----------------|--------------------------|------|--------|--------|----------|---|-----------|-------------------------------------|-------------------------------------|-------------------------------------|-------------------------------------|------|
| CMM | CH_CMM_ID | 1620 | NA | IPMI | Info | {snsrName}: CMM Identify LED (lit) | 0 | <input checked="" type="checkbox"/> | <input checked="" type="checkbox"/> | <input checked="" type="checkbox"/> | <input checked="" type="checkbox"/> | edit |
| CMM | CMM_CONFIG_IMPORTED | 3571 | NA | System | Info | CMM configuration imported | 0 | <input checked="" type="checkbox"/> | <input checked="" type="checkbox"/> | <input checked="" type="checkbox"/> | <input checked="" type="checkbox"/> | edit |
| CMM | CMM_INSERTION | 1011 | NA | IPMI | Info | Peer CMM detected | 0 | <input checked="" type="checkbox"/> | <input checked="" type="checkbox"/> | <input checked="" type="checkbox"/> | <input checked="" type="checkbox"/> | edit |
| CMM | CMM_INT_SW_ERRR | 3407 | NA | System | Critical | CMM Internal Firmware Error | 0 | <input checked="" type="checkbox"/> | <input checked="" type="checkbox"/> | <input checked="" type="checkbox"/> | <input checked="" type="checkbox"/> | edit |
| CMM | CMM_REMOVAL | 1010 | NA | IPMI | Info | Peer CMM removed | 0 | <input checked="" type="checkbox"/> | <input checked="" type="checkbox"/> | <input checked="" type="checkbox"/> | <input checked="" type="checkbox"/> | edit |
| CMM | CMM_SD_FAIL | 3623 | NA | System | Critical | Management storage failure | 300 | <input checked="" type="checkbox"/> | <input checked="" type="checkbox"/> | <input checked="" type="checkbox"/> | <input checked="" type="checkbox"/> | edit |
| CMM | CMM_SNMPSET | 3517 | NA | SNMP | Info | {ObjectID} reset (Link) via SNMPset | 12 | <input checked="" type="checkbox"/> | <input checked="" type="checkbox"/> | <input checked="" type="checkbox"/> | <input checked="" type="checkbox"/> | edit |
| CMM | CMM_STARTUP | 508 | NA | System | Info | CMM Startup - Version (CMM_Version) | 30 | <input checked="" type="checkbox"/> | <input checked="" type="checkbox"/> | <input checked="" type="checkbox"/> | <input checked="" type="checkbox"/> | edit |
| CMM | CMM_STORAGE_EXPORT_ERROR | 3572 | NA | System | Warning | CMM error exporting storage configuration | 0 | <input checked="" type="checkbox"/> | <input checked="" type="checkbox"/> | <input checked="" type="checkbox"/> | <input checked="" type="checkbox"/> | edit |
| CMM | DEVMODE | 3406 | NA | System | Debug | The CMM is in Development Mode | 0 | <input checked="" type="checkbox"/> | <input checked="" type="checkbox"/> | <input checked="" type="checkbox"/> | <input checked="" type="checkbox"/> | edit |
| CMM | FEATURE_ENABLED | 3569 | NA | System | Info | The {FeatureName} feature was enabled | 0 | <input checked="" type="checkbox"/> | <input checked="" type="checkbox"/> | <input checked="" type="checkbox"/> | <input checked="" type="checkbox"/> | edit |
| CMM | FEATURE_EXPIRED | 3504 | NA | System | Warning | Feature key has expired | 0 | <input checked="" type="checkbox"/> | <input checked="" type="checkbox"/> | <input checked="" type="checkbox"/> | <input checked="" type="checkbox"/> | edit |
| CMM | FEATURE_EXPIRING | 3503 | NA | System | Warning | Feature key expires in (remain) days | 0 | <input checked="" type="checkbox"/> | <input checked="" type="checkbox"/> | <input checked="" type="checkbox"/> | <input checked="" type="checkbox"/> | edit |
| CMM | FEATURE_RESTORED | 3570 | NA | System | Info | The {FeatureName} feature was restored | 0 | <input checked="" type="checkbox"/> | <input checked="" type="checkbox"/> | <input checked="" type="checkbox"/> | <input checked="" type="checkbox"/> | edit |
| CMM | FW_COMPONENT_UNFIT | 3403 | NA | System | Critical | Component Unfit | 0 | <input checked="" type="checkbox"/> | <input checked="" type="checkbox"/> | <input checked="" type="checkbox"/> | <input checked="" type="checkbox"/> | edit |
| CMM | FW_ROLLBACK_CANCELLED | 3306 | NA | System | Info | Firmware rollback cancelled | 0 | <input checked="" type="checkbox"/> | <input checked="" type="checkbox"/> | <input checked="" type="checkbox"/> | <input checked="" type="checkbox"/> | edit |
| CMM | FW_ROLLBACK_STARTED | 3305 | NA | System | Info | Firmware rollback started | 0 | <input checked="" type="checkbox"/> | <input checked="" type="checkbox"/> | <input checked="" type="checkbox"/> | <input checked="" type="checkbox"/> | edit |
| CMM | FW_UPDATE_FAILED | 3402 | NA | System | Critical | Firmware Update Failed | 0 | <input checked="" type="checkbox"/> | <input checked="" type="checkbox"/> | <input checked="" type="checkbox"/> | <input checked="" type="checkbox"/> | edit |
| CMM | FW_UPDATE_START | 3408 | NA | System | Info | {entity} Firmware Update Started | 0 | <input checked="" type="checkbox"/> | <input checked="" type="checkbox"/> | <input checked="" type="checkbox"/> | <input checked="" type="checkbox"/> | edit |
| CMM | FW_UPDATE_STARTED | 3307 | NA | System | Info | Firmware update started | 0 | <input checked="" type="checkbox"/> | <input checked="" type="checkbox"/> | <input checked="" type="checkbox"/> | <input checked="" type="checkbox"/> | edit |

©2006-2011 Intel Corporation

Figure 92. Settings - Event Policies Configuration Screen

Notification

The Notification screen enables an IT administrator to configure the Intel® Management Module to send alert messages to users by going through a Simple Mail Transport Protocol (SMTP) email server and to send system events to an external syslog server.

Steps to configure the Intel® Management Module to send email alert messages to users:

1. Click Settings > Notifications in the left navigation panel.
2. Enter the SMTP Mail Server Address.
3. Enter the Mail Sender Address (the “from” address).
4. Click Send a Test Email to ensure the Intel® Management Module is able to send emails.
5. Click Save Changes to save the changes.

To configure the email destination address and control the email notification settings for each user account, see [“User Accounts” on page 142](#)

To configure the events that generate email notifications, see [“Event Policies” on page 143](#).

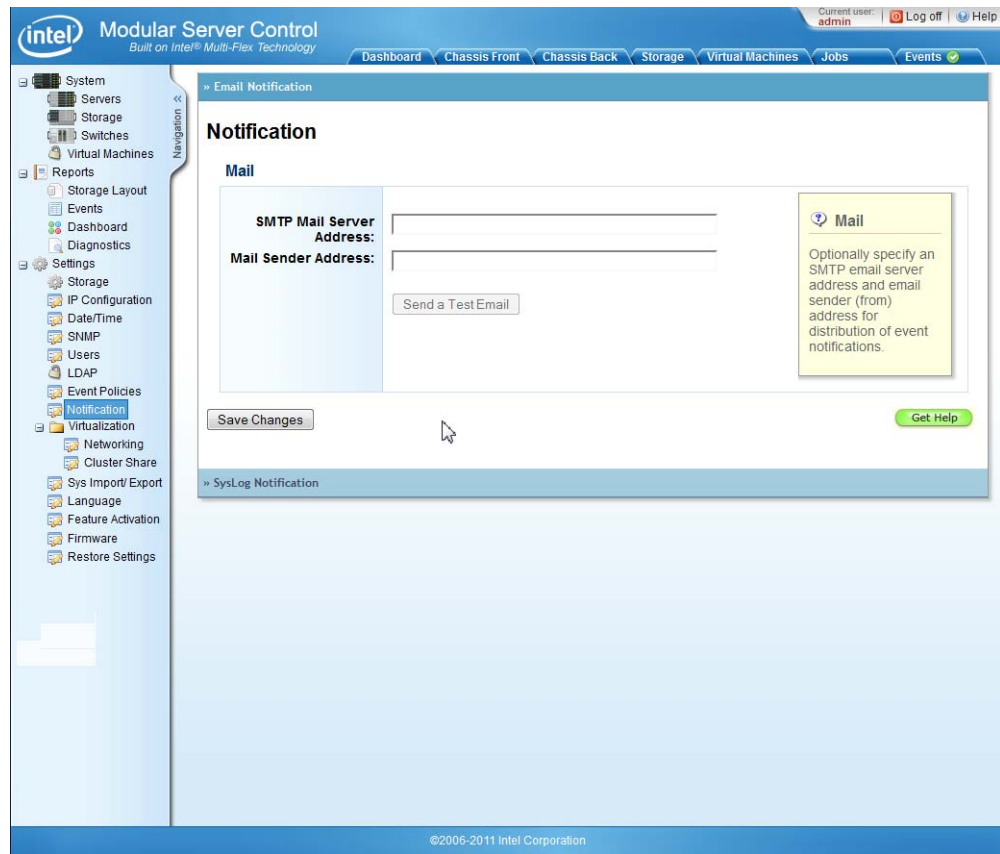

Figure 93. Email Notification Configuration

Steps to configure the Intel® Management Module to forward system events to an external syslog server

1. Click Settings > Notifications in the left navigation panel.
2. Enter the Syslog Server Address.
3. Enter the SysLog server port number.
4. Select the protocol used by the syslog server (UDP or TCP). The syslog server must support either syslogd or syslog-ng logging using either UDP (User Datagram Protocol) or TCP (Transmission Control Protocol).
5. Enter message format. The default format is as follows:
 - Event Description
 - Component
 - Event Policy information including detailed description and action information
6. Select the System Message Facility.
7. Select the Application Message Facility.

8. Select the Switch Message Facility.
9. Select the Storage Message Facility.
10. Select the Chassis Message Facility.
11. Click Save Changes to save the changes in the settings.

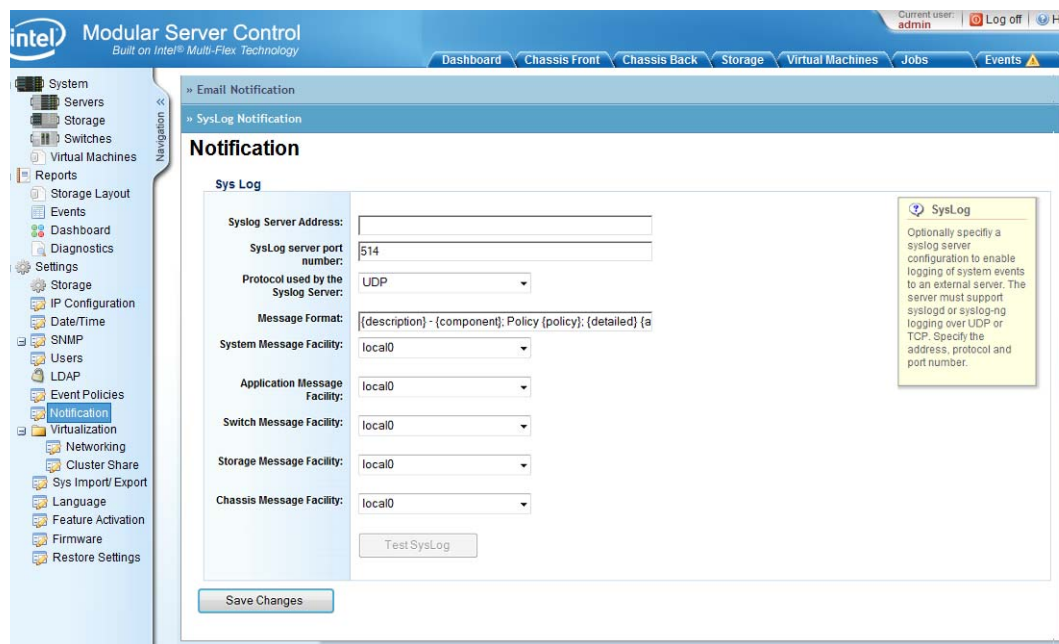

Figure 94. SYSLOG Notification Setting

Configure Networking

By default, the VMs hosted on the Modular Server are configured to work right out of the box with most networks. Tools are also provided for connecting to more complex networking environments.

The screenshot shows the Intel Modular Server Control interface. The main content area is titled 'Global Network Settings' and 'Virtual Networking'. Under 'Network Config', there are two text input fields: 'Dhcp Host Prefix' with the value 'ims_' and 'Gateway'. Below these is a checkbox for 'Simplified Networking' which is checked. A 'Save Changes' button is located below the checkbox. The 'Virtual Switches (VLANs + Bridges)' section contains a table with the following data:

| Vlan | Bond | Type | Netmask | IP1 | IP2 | IP3 | IP4 | IP5 | IP6 | Description | act |
|------|-------|--------|---------|-----|-----|-----|-----|-----|-----|------------------|------|
| 4081 | bond1 | static | ✓ | ✓ | ✓ | ✓ | ✓ | ✓ | ✓ | Internal Cluster | edit |
| 4082 | bond2 | static | ✓ | ✓ | ✓ | ✓ | ✓ | ✓ | ✓ | Backup & CDP | edit |
| 101 | bond1 | dhcp | | | | | | | | Default | edit |
| 102 | bond2 | dhcp | | | | | | | | User 2 | edit |

Figure 95. Networking Screen

To configure Networking:

1. Enter the DHCP Host Prefix in the text box provided. The Host Prefix acts as a unique identifier for the Modular Server when communicating with a DHCP server, and is useful to avoid IP confusion when multiple IMS systems are on the same network. It is recommended to give each Modular Server a unique prefix.
2. If the external network is set up to use a Gateway system to access, enter the IP address in the text box provided.
3. Check Simplified Networking to implement the Modular Server's automated networking scheme (this is the default), and should be sufficient for most applications. This solution will work with most networking environments, and handles all the behind the scenes configuration. Alternatively, the user may uncheck the box and configure the network and ports manually, using the System > Switches screen. See the following section for detailed information.

Simplified Networking:

The easiest solution for networking a virtualized Modular Server is Simplified Networking. This feature is enabled by default.

Simplified Networking insures that the Virtual Machines and non-virtualized compute modules will be networked together seamlessly within the Modular Server, and will connect out of the box with a larger network.

Simplified Networking achieves this by changing ports using the default PVID (port VLAN ID) from 1 to 101. Virtual Machines cannot address the untagged PVID 1. Changing the port ensures the entire system runs smoothly. Simplified Networking does not change ports that have been configured by the user.

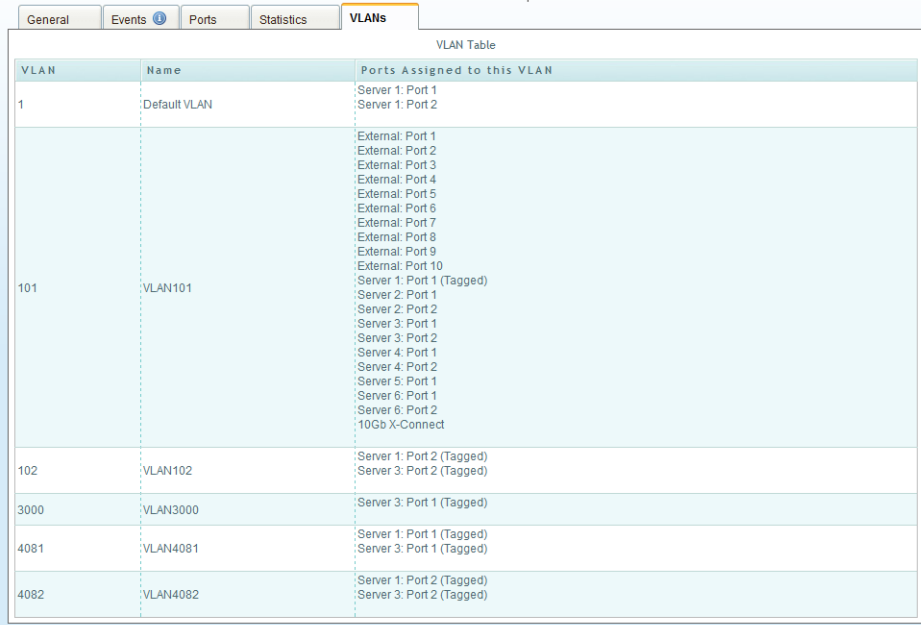

| VLAN | Name | Ports Assigned to this VLAN |
|------|--------------|--|
| 1 | Default VLAN | Server 1: Port 1 Server 1: Port 2 |
| 101 | VLAN101 | External: Port 1 External: Port 2 External: Port 3 External: Port 4 External: Port 5 External: Port 6 External: Port 7 External: Port 8 External: Port 9 External: Port 10 Server 1: Port 1 (Tagged) Server 2: Port 1 Server 2: Port 2 Server 3: Port 1 Server 3: Port 2 Server 4: Port 1 Server 4: Port 2 Server 5: Port 1 Server 6: Port 1 Server 6: Port 2 10Gb X-Connect |
| 102 | VLAN102 | Server 1: Port 2 (Tagged) Server 3: Port 2 (Tagged) |
| 3000 | VLAN3000 | Server 3: Port 1 (Tagged) |
| 4081 | VLAN4081 | Server 1: Port 1 (Tagged) Server 3: Port 1 (Tagged) |
| 4082 | VLAN4082 | Server 1: Port 2 (Tagged) Server 3: Port 2 (Tagged) |

Figure 96. Vlan port listing - Switch screen

For more advanced networks that use trunked ports, or link aggregation, Simplified Networking may not be the best choice. If Simplified Networking is turned off, the Modular Server will still manage the internal ports for the Virtual Machines, but external ports and non-virtualized compute modules will need to be configured using the System > Switches screen.

Note: Before manually configuring a switch, use the switch Reset action on the System > Switches page. Check the Reset to Factory Defaults box. This removes the Simplified Networking configuration and returns the switch to its original state.

Virtual Switches

The Virtual Switches control how the VM connects to the network. Once created here, these Vlans may be assigned to individual VMs, appearing as options under the VLAN drop down menu in the Create VM or Modify VM actions.

The Modular Server comes with commonly used Vlans configured by default.

- Default (VLAN 101) - This default selection sets up a virtual switch with a single VLAN. This choice is pre-configured to work with most networks, and allows both internal and external traffic.
- User 2 (VLAN 102) - This selection is configured like the Default selection, using a different user. This will work the same as Default and may be set up to add redundancy to the VM's network connections.
- Internal Cluster (VLAN 4081) - This selection is configured to communicate with the internal Modular Server network.
- Backup & CDP (VLAN 4082) - This selection is configured to add a dedicated network connection for real time backup & CDP services.

Users are able to create other VLAN connections as needed. A user may want to assign a different VLAN for each VM to reduce overhead and thus more efficiently use networking resources, as well as diversify risk in case a VLAN should malfunction.

Note: Additional Vlans are automatically configured using the port assignments in the chosen bond. To add additional external ports, use the Advanced Configuration action on the hardware switch. See “Configuring an Intel® Gigabit Ethernet Switch” on page 87

To Create or Edit Virtual Switches:

1. To add a VLAN, choose the Add VLAN button. To edit the newly created VLAN, or any existing VLAN, choose the Edit link of the target VLAN.
2. Enter a VLAN number to uniquely identify the Virtual Switch
3. Choose a Bond to use. Each compute module has 2 internal and two external ports. Bond1 routes traffic through ports 1 & 3. Bond2 routes traffic through ports 2 & 4. When assigned, the Ports assigned to the VLAN may be viewed by navigating to System > Switches > VLAN tab. See [Figure 96 on page -149](#)
4. Enter a Type for the IP assignment for the Virtual Switch. If DHCP, or None is chosen, no further IP configuration is needed.
5. If Static is selected for the Type, enter the Netmask the Modular Server is currently connected to. Retrieve this information from the local network.
6. If Static is selected for the Type, enter an IP Address to be used for IP1-IP6. These correspond with the compute modules 1-6, for example: IP1 references the module in chassis slot 1.
7. Enter a short description of the Virtual Switch in the Description field.

8. Choose the Update button.

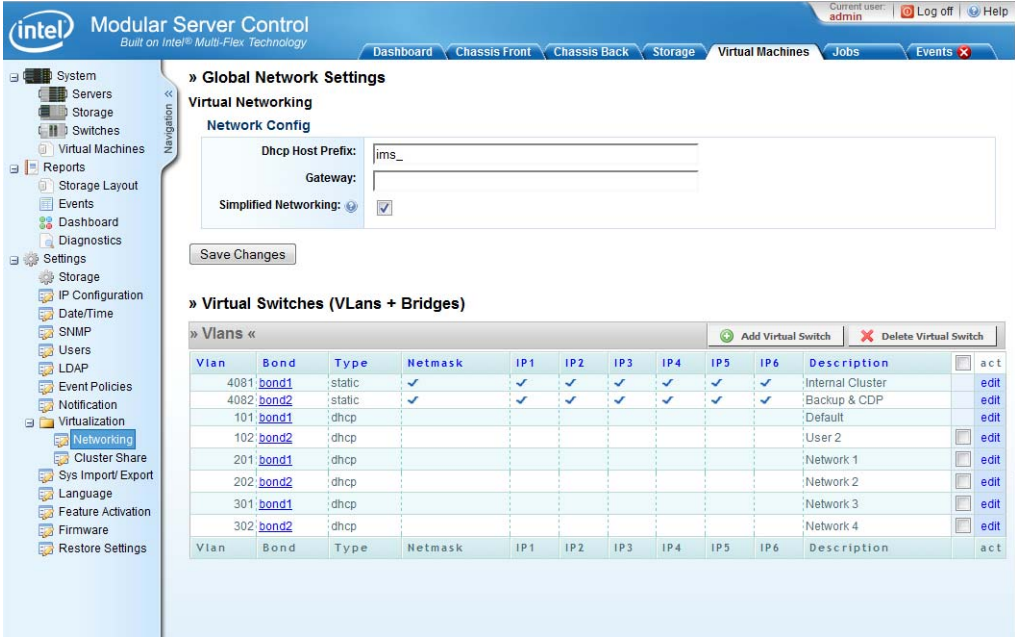

Figure 97. Networking: Additional Vlan Added

Cluster Share Screen

Due to their abstracted nature, Virtual Machines have no physical ports or media drives normally used to install software. Software and files are transferred to Virtual Machines using a shared folder in the area known as the ISO Store.

The Cluster Share shares the ISO Store directory on the Modular Server. This pre-installed folder is reserved to hold software and data for use by virtual machines.

Note: It's recommended to Disable the Cluster Share when not in use for security reasons.

Populating the ISO Store

If the ISO Store has not been set up yet or is empty, a user may transfer files into the Modular Server by configuring the Cluster Share:

1. Select Settings > Virtualization > Cluster Share from the side navigation menu. This screen configures the sharing of the ISO Store folder.

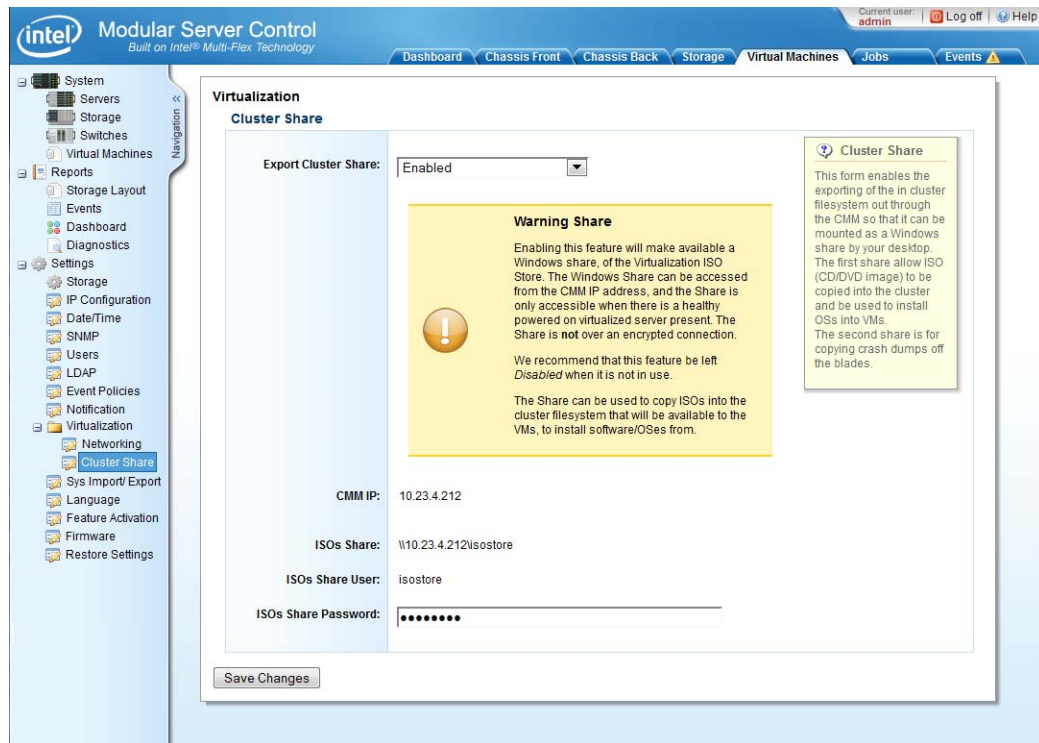

Figure 98. Cluster Share Configuration Screen

2. Select Enabled from the Export Cluster Share drop down menu.
3. Enter a password for the ISO Share.
4. Choose the Save Changes button.

Now the ISO Store is configured, files are transferred by mapping a folder on a local machine to the Modular Server. Once mapped, files dropped into the local folder will be added to the Modular Server.

To Map a Folder on a Windows 7 system:

1. Select the Windows menu and select Computer.
2. From the menu on the top of the window, select the Map Network Drive.

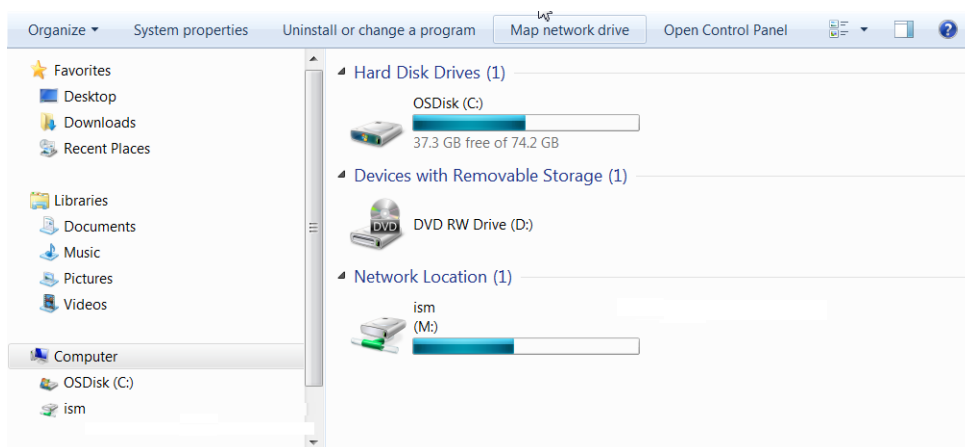

Figure 99. Windows 7: Computer Screen

3. The Map Network Drive window will appear. Copy the address shown in the ISO Share field on the Cluster Share screen, and paste the address into the Folder field of the Map Network Drive window.

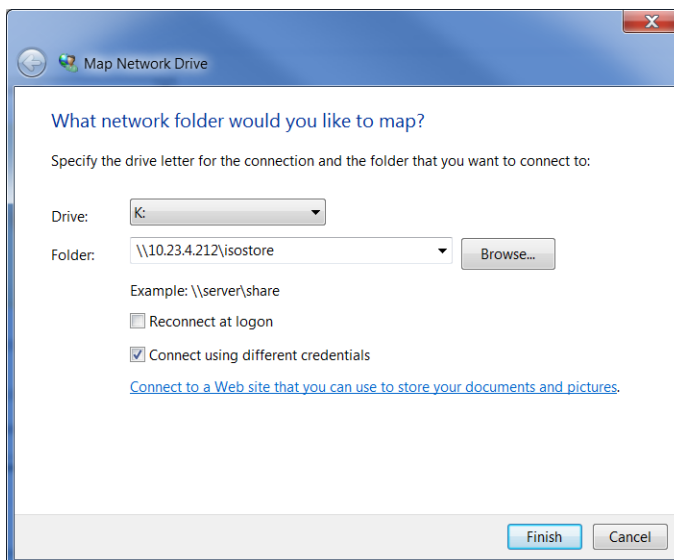

Figure 100. Window 7: Map Network Drive Pop Up

4. Uncheck the Reconnect at logon checkbox.
5. Check the Connect using different credentials checkbox.

6. Choose Finish.
7. Enter 'isostore' into the login, and the password entered in the Cluster Share screen.

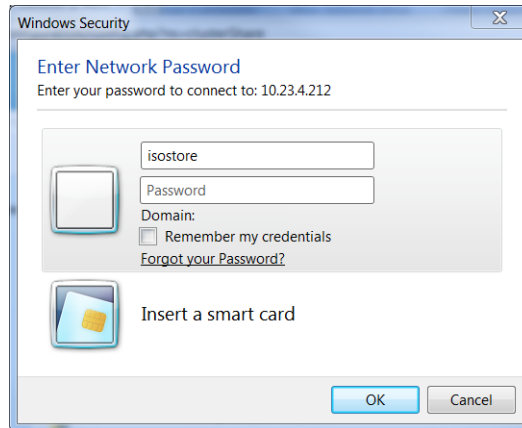

Figure 101. Windows 7: Mapped Drive Login Pop Up

The folder will now open. Files dragged into this folder will be transferred to the ISO Store.

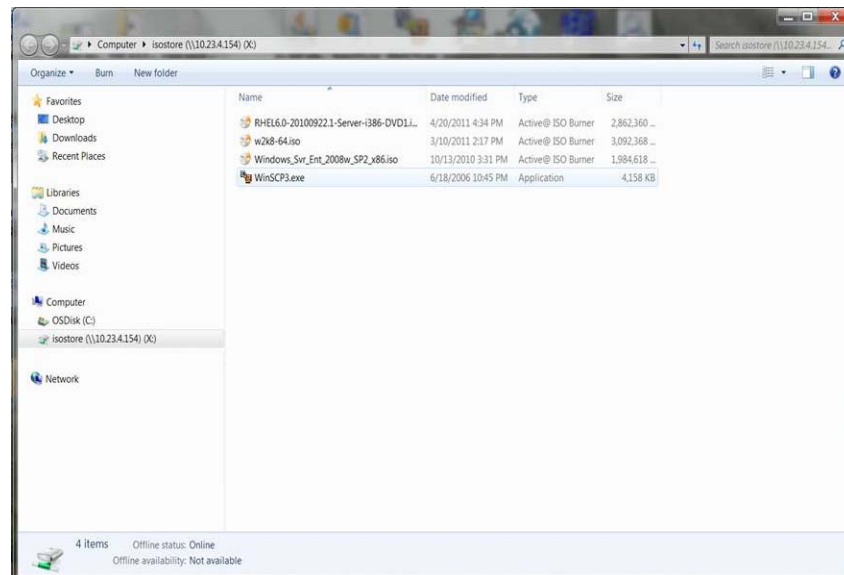

Figure 102. Mapped Remote Folder

Sys Import/Export

It allows you to export the configuration of CMM, Event Policies, Users, Switch, and Storage from one chassis and import to a chassis with a similar configuration.

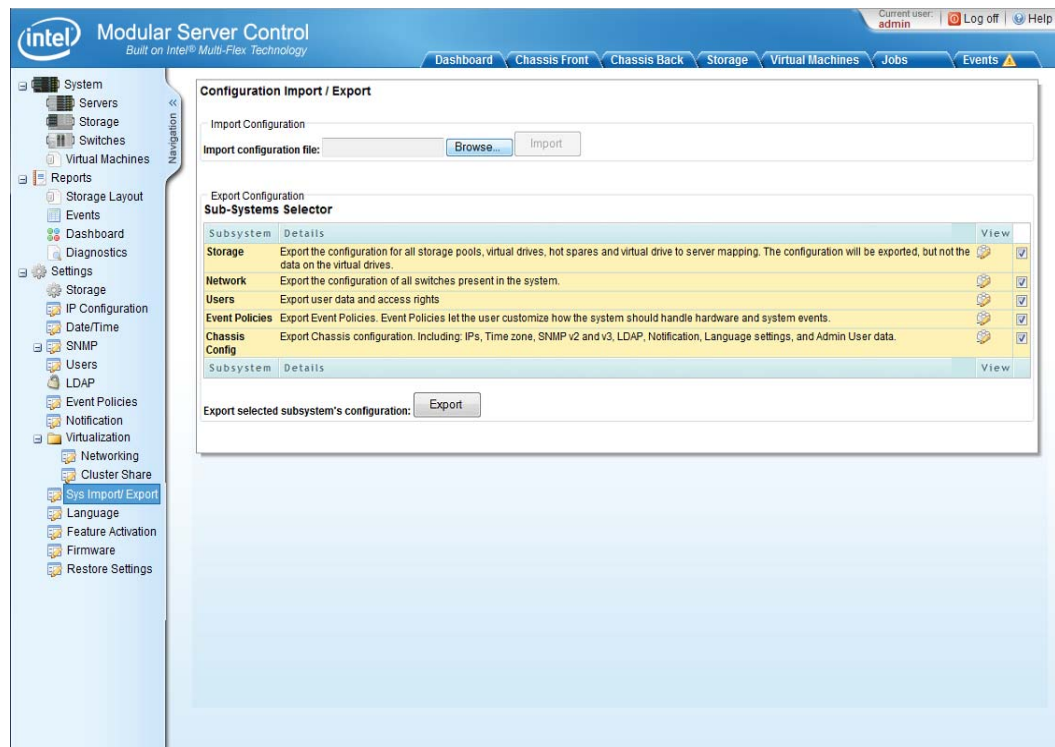

Figure 103. Sys Import /Export

Language Option Setting

The Intel® Modular Server Control UI provides the capability to change the language for the on-line help content. Available languages are:

- English
- Russian
- Simplified Chinese

Steps to change the language of the on-line Help

1. Click Settings > Language in the left navigation panel.
2. Select a language for the online help.
3. Click Save Changes to save the changes.

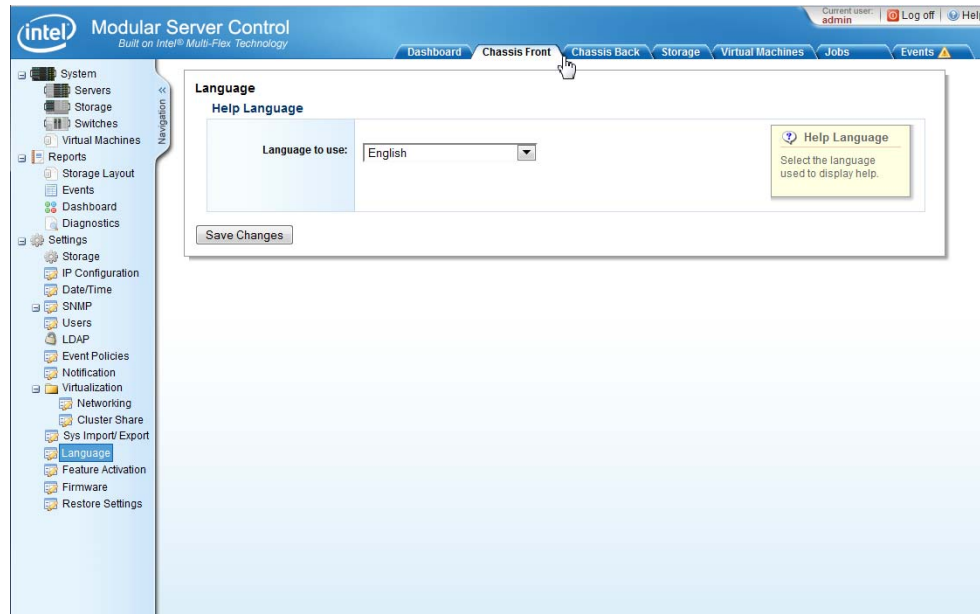

Figure 104. Settings - Help Language Selection

Feature Activation

The Intel[®] Modular Server Control UI provides the capability to activate features using a feature activation code or key. The following feature requires activation before you can use it:

- Intel[®] Shared LUN Feature: The Intel[®] Shared LUN Feature allows two or more servers to share a virtual drive. This feature requires operating system support for sharing LUNs.
- Intel[®] Modular Server Storage Management Pack Features: With the Intel[®] Modular Server Storage Management Pack (Formerly Intel[®] LUN Copier), you will be able to perform many advanced storage operations such as:
 - Making local copies of any LUN (Virtual Drive) when it is not being actively used by a compute module. This is useful for creating quick local backups, and for provisioning a server,
 - Changing the RAID level of a virtual drive even when it is in use. This enables RAID morphing, and performance optimizations without application downtime,
 - Defragmenting a storage pool. This combines fragmented free space to allow the creation of larger virtual drives.
- Intel[®] Modular Server Advanced Management Pack Feature: The Intel[®] Modular Server Advanced Management Pack upgrade offers enhanced management capabilities and allows users to more easily deploy multiple chassis. It includes the following features:
 - authentication of users using an LDAP server

- forwarding events to an external SysLog server
- exporting and importing chassis settings including the storage and switch configuration
- Intel® Modular Server Virtualization Manager: Gives the administrator the ability to add and manage virtualization on the Modular Server using a simple, easy to use graphical interface. With virtualization, compute modules are able to run multiple virtual machines, which in turn may run any software normally installed on the Modular Server. Virtual machines also are able to take advantage of several additional features, such as drag and drop migration.

Steps to activate a feature

1. Obtain a feature activation code or key. Contact your Intel Sales representative for information on how to obtain a key.
2. Click Settings > Feature Activation in the left navigation panel.
3. Enter your activation code.
4. Click Add.

The screenshot shows the Intel Modular Server Control interface. The top navigation bar includes 'Dashboard', 'Chassis Front', 'Chassis Back', 'Storage', 'Virtual Machines', 'Jobs', and 'Events'. The left navigation menu is expanded to 'Settings', with 'Feature Activation' selected. The main content area is titled 'Feature Activation' and displays the following information:

Feature Activation
Chassis Serial Number: BZMD82700136
No feature keys have been activated.
Enter New Feature Key

Features Available
Rollover ⓘ for detailed information

| Feature | Status | Key Expiry |
|--|---|------------|
| Intel® Shared LUN ⓘ | Enabled - This feature is currently under evaluation. | In 12 days |
| Intel® Modular Server Storage Management Pack ⓘ | Enabled - This feature is currently under evaluation. | In 12 days |
| Intel® Modular Server Advanced Management Pack ⓘ | Inactive Evaluate this feature for 30 days... | |
| Intel® Modular Server Virtualization Manager ⓘ | Enabled - This feature is currently under evaluation. | In 12 days |

A yellow callout box on the right side of the page contains the text: 'This page allows you to enable additional features by entering a key purchased from your hardware vendor.' with a 'Get Help' button.

Figure 105. Settings - Feature Activation

Firmware Updates

The Intel® Modular Server Control UI provides a simple interface to update the system firmware from a single compressed update package released by Intel called an UFU (Unified Firmware Update). In addition to providing an easy-to-use interface to update the firmware for the entire system, this screen will display all currently installed component firmware versions, as well as current status. This will enable the IT administrator to quickly view the installed versions and determine if an update is required.

The Unified Firmware Update supports firmware updates for the management module, storage control modules, switch modules, fans, server BIOS, and firmware.

Firmware
 Current Build Version: 3.0.100.20090504.17040
 Prior Version: 2.6.100.20081104.14276

Upload New Firmware

Firmware Inventory
 Rollover for detailed information

| Component | Subsystem | Status | Current Version |
|--------------------------|--------------|----------------|------------------------------------|
| Server 1 | BMC Firmware | ok | 1.15.1 |
| | BMC Boot | ok | 0.25 |
| | BIOS | ok | 8B5000.86B.01.10.0034.050420091255 |
| Server 2 | BMC Firmware | ok | 1.35.30 |
| | BMC Boot | ok | 0.9 |
| | BIOS | ok | 8B5000.86B.10.10.0048.112120081113 |
| Server 3 | BMC Firmware | ok | 1.35.30 |
| | BMC Boot | ok | 0.9 |
| | BIOS | ok | 8B5000.86B.10.10.0048.112120081113 |
| Server 4 | BMC Firmware | ok | 1.35.30 |
| | BMC Boot | ok | 0.9 |
| | BIOS | ok | 8B5000.86B.10.10.0048.112120081113 |
| Server 5 | BMC Firmware | ok | 1.35.30 |
| | BMC Boot | ok | 0.9 |
| | BIOS | ok | 8B5000.86B.10.10.0048.112120081113 |
| Server 6 | BMC Firmware | ok | 1.35.30 |
| | BMC Boot | ok | 0.9 |
| | BIOS | ok | 8B5000.86B.10.10.0048.112120081113 |
| Switch 1 | Firmware | ok | 1.0.0.27 |
| | Boot | ok | 1.0.0.6 |
| Switch 2 | Firmware | not present | -- |
| | Boot | not present | -- |
| Storage Control Module 1 | Firmware | ok | 3.2.140.15 |
| Storage Control Module 2 | Firmware | ok | 3.2.140.15 |
| System Fan 1 | Firmware | ok | 1.2 |
| | Boot | ok | 1.2 |
| System Fan 2 | Firmware | ok | 1.2 |
| | Boot | ok | 1.2 |
| I/O Fan | Firmware | ok | 1.2 |
| | Boot | ok | 1.2 |
| Power Supply 1 | Firmware | not applicable | -- |
| | Boot | not applicable | -- |
| Power Supply 2 | Firmware | not applicable | -- |
| | Boot | not applicable | -- |
| Power Supply 3 | Firmware | not applicable | -- |
| | Boot | not applicable | -- |
| Power Supply Blank 4 | Firmware | ok | 1.2 |
| | Boot | ok | 1.2 |

Figure 106. Settings - Firmware Update Screen

Steps to Update the System Firmware

1. Click Settings > Firmware in the left navigation panel.
2. In the Upload New Firmware section, click Browse.
3. Select the file from the console system. File must be accessible from the console system.

Refer to the *Unified Firmware Update Release Notes* for detailed instructions on how to update the system firmware.

Restore System Settings

It may be necessary to restore your system configuration to an earlier time or to factory defaults. The following settings are affected:

- Users and passwords used to access the UI.
- Network configuration (management module IP address)
- Event policies
- Notification settings (email addresses)
- SNMP configuration

To restore system settings, click Settings > Restore Settings in the left navigation panel.

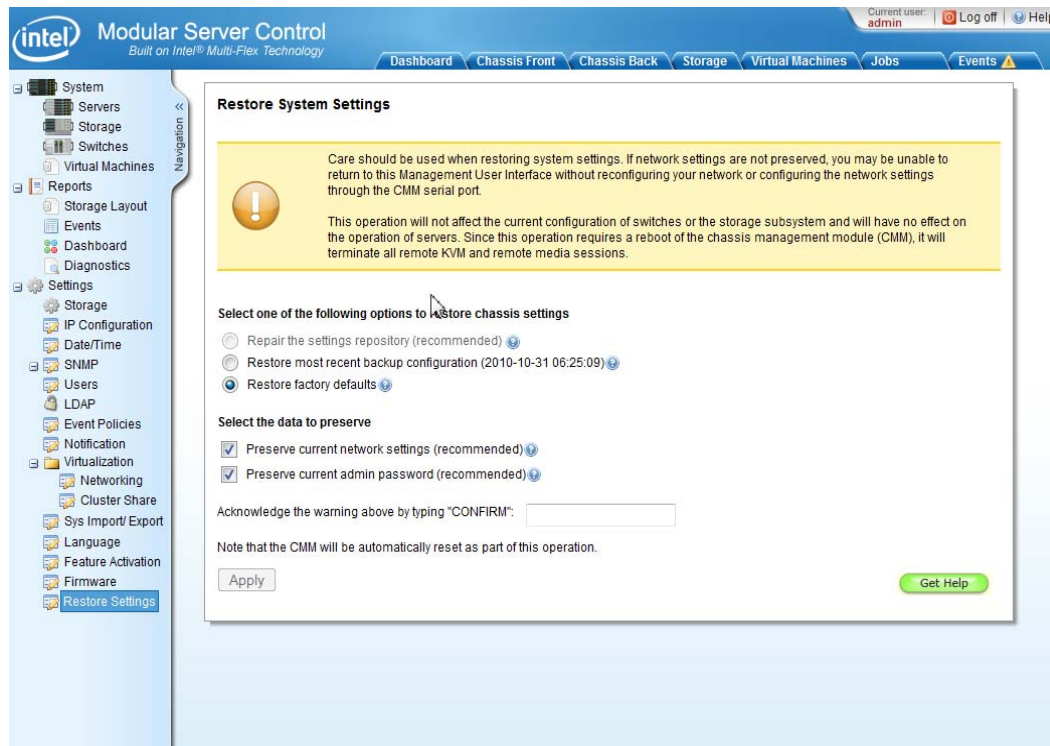

Figure 107. Settings - Restore System Settings

Restore Options

One of the following three methods may be used to restore system settings:

1. Repair the settings repository

It is possible, but rare, for system settings to become corrupt after an unexpected chassis power loss. This option is only available to the administrative user and only when system settings are actually corrupt.

After selecting this option and clicking **Apply**, the management module will reset. As the management module boots, the settings will be repaired. If this operation is unsuccessful, the management module will automatically attempt to restore the most recent backup settings (see explanation below).

2. Restore the most recent backup

System settings are automatically backed up each time the management module is reset or inserted into the chassis, and backups are made daily thereafter. Choose this option to revert to the most recent backup configuration. The dialog indicates the date of the last known backup.

After selecting this option and clicking **Apply**, the management module will reset. As the management module boots, the backup settings will be applied. If this process fails, the management module settings will be automatically restored to factory defaults corresponding to the installed firmware version (see explanation below).

3. Restore factory defaults

Removes all setting changes made by the customer and clears the event log. All user accounts other than the administrative user will be removed. Restores factory defaults corresponding to the installed firmware version (which may differ from the original defaults set in the factory if the chassis firmware has been updated).

After selecting this option and clicking **Apply**, the management module will reset. As the management module boots, factory defaults are restored.

Preserving Critical Data

The following two additional options may be selected to preserve certain settings that may be difficult to reconfigure:

1. Preserve current network settings:

If network settings are not preserved, you may be unable to return to the management UI without reconfiguring your network or configuring the network settings through the management module serial port.

2. Preserve current administrative password:

If the password for the administrative account is not preserved, you will need to either log in to the UI using the administrative account password saved at the time of the backup if “Restore most recent backup configuration (date and time stamp)” is selected, or use the factory default password if “Restore factory defaults” is selected. If restoring from factory defaults, check the user manual for the factory default password (this password is not affected by any prior firmware updates).

Access Online Help

The Help link located at the top right of the banner opens the Intel® Modular Server Control Help in a new window. Use the table of contents to quickly access help and tips for specific screens and functions.

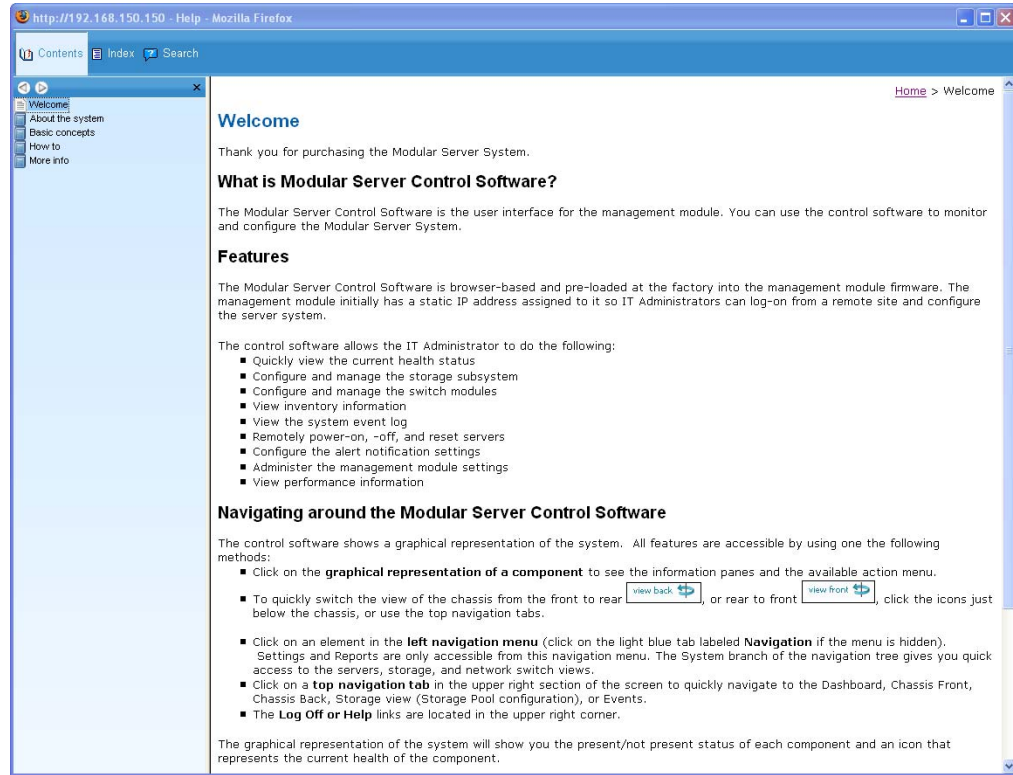

Figure 108. Online Help

Log Out from the Intel[®] Modular Server Control

The Log Off link is located at the top right of the banner. Clicking it ends the current Intel[®] Modular Server Control session and returns the user to the login screen.

5 Troubleshooting

This chapter provides information to assist in troubleshooting the Intel® Modular Server System MFSYS25V2.

A common cause of system function issues is outdated firmware. Before performing extensive troubleshooting steps, ensure that all installed system components are configured with current firmware, including the management module, storage control modules and Ethernet switch modules. Also, ensure that the installed compute modules have all been configured with the latest BIOS and BMC firmware code, and device drivers. Current firmware and driver packages are available for download from:

<http://downloadcenter.intel.com/SearchResult.aspx?lang=eng&ProductFamily=Server+Products&ProductLine=Intel%20%ae+Modular+Server+Systems&ProductProduct=Intel%20%ae+Modular+Server+System+MFSYS25V2>

http://www.intel.com/p/en_US/support/highlights/server/mfs5520vi

First Steps Checklist

- Is the power LED lit on all modules installed in the Intel® Modular Server System MFSYS25V2?
- Is the chassis properly connected to an AC power source?
- Are the various chassis modules fully seated?
 - Power supply modules
 - Management module
 - Storage control modules
 - Ethernet switch modules
 - Fan modules
- Are the installed compute modules fully seated?

Specific Issues and Corrective Actions

This section provides possible solutions for these specific problems:

- Chassis fan module not functioning
- Cannot connect to management module
- Cannot connect to a compute module
- Cannot connect a compute module to a storage control module

Try the following solutions in the order given. If you still cannot correct the problem, contact your service representative or authorized dealer for help.

Chassis Fan Module Not Functioning

Check the following:

- Is only a single fan in error? If so, check the power and fault LEDs.
- Is the power LED on? If not, re-seat the fan module. If so, check the fault LED.
- Is the fault LED on? Check the status of the system using the Intel® Modular Server Control.
- Are both fan modules in error? If so, verify that the power supply modules are properly installed and connected to grounded AC outlets.

Cannot Connect to the Management Module

Check the following:

- Is the power LED lit?
- If not, is it the only module in the system with an unlit power LED?
 - If so, re-seat the module, or try replacing it with a different module.
 - If not, verify that the chassis power supply modules are properly installed and connected to grounded AC outlets.
- Is the fault LED lit?
 - If so, re-seat the module, or try replacing it with a different module
 - If not, verify that the chassis power supply modules are properly installed and connected to grounded AC outlets.
- Is the Ethernet management port connected to the network?
 - If yes, is the cable good? Try replacing the cable.
 - If yes, is the management module configured properly for the network to which it is connected? Try resetting the management module by pushing the management module reset button.

Cannot Connect to a Compute Module

Check the following:

- Verify that all jumpers are located in the proper default positions (CMOS Clear J1F2: default pins 1-2; BMC Force Update J7A1: default pins 2-3).
- Is the compute module powered on and operating normally?
 - If so, is an operating system installed on the compute module?
 - If so, is the operating system installed on the compute module operating properly and configured properly for the network?

- Verify that both the compute module and the client are connected to the correct physical LAN and VLAN?
- Is the power LED lit on the Ethernet switch module?
 - If not, try to re-seat the switch module
 - If so, check the fault LED on the switch module
- Is the power fault LED lit on the Ethernet switch module?
 - If so, check the status of the system using the Intel[®] Modular Server Control.
 - If not, check the switch port link.
- Is the switch connected to the network by way of an Ethernet cable?
 - If not, connect the switch to the network.
 - If so, verify that the link light is lit for the connected port.
- Is the link light lit for the connected port?
 - If not, move the Ethernet cable to a different port. If the link light on the other port does not light, replace the cable.

If the switches and connections are correct and AC power is available at the wall outlet, contact your service representative or authorized dealer for additional help.

Cannot Connect a Compute Module to a Storage Control Module

Check the following:

- Verify that storage space in the storage control module has been allocated for and assigned to the compute module.
- Make sure the drive(s) assigned to the compute module are installed and operating properly.
- Make sure the installed drives are validated for use with the Intel[®] Modular Server System MFSYS25V2. Refer to the *Intel[®] Modular Server System Tested Hardware and Operation System List* for validation information.
- Check the status of the system using the Intel[®] Modular Server Control.

Diagnostic LED Information

The various modules and compute modules designed for use with the Intel[®] Modular Server System MFSYS25V2 provide a number of diagnostic LEDs that may aid in troubleshooting your system. A list of these LEDs, with usage descriptions for each LED, is provided in the following two tables.

Table 37. Diagnostic LEDs

| LED Name | Function | Location | Color | Indicator |
|--|---|------------------------------------|--------------|---|
| Chassis ID LED | Aids in server identification from the back panel | Chassis front | Blue | Press ID LED button or use Management Module UI software to turn off the LED. |
| System Fault LED | Visible fault warning | Chassis front | Amber | Green = No Fault Green Blink = Degraded Amber = Critical error or non-recoverable Amber blink = Non-critical |
| Hard Drive Power/Activity LED | Identifies the power state of the hard drive, indicate drive activity | Hard drive carrier front panel | Green | On = Hard drive power on Green Blink = Hard drive activity |
| Hard Drive Fault LED | Visible fault warning | Hard drive carrier front panel | Amber | On = Hard drive fault |
| I/O Cooling Module Power LED | Identifies the power state of the I/O cooling module | I/O cooling module front panel | Green | On = Cooling module power on |
| I/O Cooling Module Fault LED | Visible fault warning | I/O cooling module front panel | Amber | On = I/O cooling module fault |
| Fan Module Power LED | Identifies the power state of the fan module | Fan module front panel | Green | On = Fan module power on |
| Fan Module Fault LED | Visible fault warning | Fan module front panel | Amber | On = Fan module fault |
| Storage Control Module Power LED | Identifies the power state of the storage control module | Storage control module front panel | Green | On = Storage control module power on |
| Storage Control Module Fault LED | Visible fault warning | Storage control module front panel | Amber | On = Storage control module fault |
| Storage Control Module Dirty Cache LED | Identifies the state of storage control module cache | Storage control module front panel | Green | Slow blink = Dirty cache |
| Ethernet Switch Module Power LED | Identifies the power state of the Ethernet switch module | Ethernet switch module front panel | Green | On = Ethernet switch module power on |
| Ethernet Switch Module Fault LED | Visible fault warning | Ethernet switch module front panel | Amber | On = Ethernet switch module fault |

| LED Name | Function | Location | Color | Indicator |
|---|---|---------------------------------|-------|---|
| Ethernet Switch Module Port Link/Activity LED | Active Ethernet Port Link | Ethernet switch port | Green | On green = Link Blinking Green = Port activity |
| Management Module Power LED | Identifies the power state of the management module | Management module front panel | Green | On = Management module power on |
| Management Fault LED | Visible fault warning | Management module front panel | Amber | On = Management module fault |
| Power Supply Module Power LED | Identifies the power state of the Power Supply module | Power supply module front panel | Green | On = Power supply module power on |
| Power Supply Fault LED | Visible fault warning | Power supply module front panel | Amber | On = Power supply module fault |

Table 38. NIC LEDs

| LED Color | LED State | Description |
|-----------|----------------|--|
| Left LED | Off | No network connection |
| | Solid Amber | Network connection in place |
| | Blinking Amber | Transmit/receive activity |
| Right LED | Off | 10 Mbps connection (if Left LED is on or blinking) |
| | Solid Amber | 100 Mbps connection |
| | Solid Green | 1000 Mbps connection |

Appendix A: Product Regulatory Requirements

Regulatory and Certification Information

Warning: *To ensure regulatory compliance, you must adhere to the assembly instructions in this guide to ensure and maintain compliance with existing product certifications and approvals. Use only the described, regulated components specified in this guide. Use of other products/components will void the UL listing and other regulatory approvals of the product and will most likely result in noncompliance with product regulations in the region(s) in which the product is sold.*

To help ensure EMC compliance with your local regional rules and regulations, before computer integration, make sure that the chassis, power supply, and other modules have passed EMC testing using a server board with a microprocessor from the same family (or higher) and operating at the same (or higher) speed as the microprocessor used on this server board. The final configuration of your end system product may require additional EMC compliance testing. For more information please contact your local Intel Representative.

This is an FCC Class A device. Integration of it into a Class B chassis does not result in a Class B device.

Product Regulatory Compliance

The Server Chassis product, when correctly integrated per this guide, complies with the following safety, electromagnetic compatibility (EMC), and Product Ecology regulations and requirements.

Intended Application - This product was evaluated as Information Technology Equipment (ITE), which may be installed in offices, schools, computer rooms, and similar commercial type locations. The suitability of this product for other product categories and environments (such as: medical, industrial, telecommunications, NEBS, residential, alarm systems, test equipment, etc.), other than an ITE application, may require further evaluation.

Product Safety Compliance

UL60950 - CSA 60950(USA/Canada)
EN60950 (Europe)
IEC60950 (International)
CB Certificate & Report, IEC60950 (report to include all country national deviations)
GS Certification (Germany)
GOST R 50377-92 - Certification (Russia)

Belarus Certification (Belarus)
Ukraine Certification (Ukraine)
CE - Low Voltage Directive 73/23/EEE (Europe)
IRAM Certification (Argentina)

Product EMC Compliance - Class A Compliance

FCC /ICES-003 - Emissions (USA/Canada) Verification
CISPR 22 - Emissions (International)
EN55022 - Emissions (Europe)
EN55024 - Immunity (Europe)
EN61000-3-2 - Harmonics (Europe)
EN61000-3-3 - Voltage Flicker (Europe)
CE - EMC Directive 89/336/EEC (Europe)
VCCI Emissions (Japan)
AS/NZS 3548 Emissions (Australia/New Zealand)
BSMI CNS13438 Emissions (Taiwan)
GOST R 29216-91 Emissions (Russia)
GOST R 50628-95 Immunity (Russia)
Belarus Certification (Belarus)
Ukraine Certification (Ukraine)
KCC Notice No. 1997-41 (EMC) & 1997-42 (EMI) (Korea)

Product Ecology Compliance

Intel has a system in place to restrict the use of banned substances in accordance with world wide regulatory requirements. A Material Declaration Data Sheet is available for Intel products. For more reference on material restrictions and compliance you can view Intel's Environmental Product Content Specification at <http://supplier.intel.com/ehs/environmental.htm>.

Europe - European Directive 2002/95/EC

Restriction of Hazardous Substances (RoHS)
Threshold limits and banned substances are noted below.
Quantity limit of 0.1% by mass (1000 PPM) for:
Lead, Mercury, Hexavalent Chromium, Polybrominated Biphenyls Diphenyl Ethers (PBB/PBDE)
Quantity limit of 0.01% by mass (100 PPM) for:
Cadmium

California Code of Regulations, Title 22, Division 4.5, Chapter 33:

Best Management Practices for Perchlorate Materials

China - Restriction of Hazardous Substances (China RoHS)

WEEE Directive (Europe)

Packaging Directive (Europe)





REACH Directive (Europe)

Certifications/Registrations/Declarations

UL Certification (US/Canada)
 CE Declaration of Conformity (CENELEC Europe)
 FCC/ICES-003 Class A Attestation (USA/Canada)
 VCCI Certification (Japan)
 C-Tick Declaration of Conformity (Australia)
 MED Declaration of Conformity (New Zealand)
 BSMI Certification (Taiwan)
 GOST R Certification/License (Russia)
 Belarus Certification/License (Belarus)
 KCC Certification (Korea)
 IRAM Certification (Argentina)
 Ecology Declaration (International)
 China RoHS Environmental Friendly Use Period
 Packaging & Product Recycling Marks





Product Regulatory Compliance Markings



This Intel Server Chassis product is provided with the following regulatory and safety markings. In the event there is no room for a marking(s) on the chassis, the information is provided here in the product guide.

| Requirement | Country | Marking |
|---------------------|------------|---|
| cULus Listing Marks | USA/Canada |  |
| GS Mark | Germany |   |
| CE Mark | Europe |  |

| Requirement | Country | Marking |
|--------------------------------------|---------|---|
| FCC Marking (Class A) | USA | This device complies with Part 15 of the FCC Rules. Operation of this device is subject to the following two conditions: (1) This device may not cause harmful interference, and (2) This device must accept any interference received, including interference that may cause undesired operation. Manufactured by Intel Corporation |
| EMC Marking (Class A) | Canada | CANADA ICES-003 CLASS A CANADA NMB-003 CLASSE A |
| VCCI Marking (Class A) | Japan | この装置は、クラス A 情報技術装置です。この装置を家庭環境で使用すると電波妨害を引き起こすことがあります。この場合には使用者が適切な対策を講ずるよう要求されることがあります。VCCI-A |
| BSMI Certification & Class A Warning | Taiwan |  <div style="border: 1px solid black; padding: 5px;"> <p>警告使用者： 這是甲類的資訊產品，在居住的環境中使用時，可能會造成射頻干擾，在這種情況下，使用者會被要求採取某些適當的對策</p> </div> |
| GOST R Marking | Russia |  |
| KCC Mark | Korea | Note: The following is the former Korean EMC mark and is seen on older Intel products.  |

| Requirement | Country | Marking | | | | |
|---|-----------|---|-----------|---------------|---------------|-----------------|
| KCC Mark | Korea | Note: The following symbol is the new Korean EMC mark and is seen on newer Intel products.  | | | | |
| 于符合中国《电子信息产品污染控制管理法》的声明 Management Methods on Control of Pollution from Electronic Information Products (China RoHS declaration) 品中有毒有害物 . 的名称及含量 | | | | | | |
| 部件名称 (Parts) | | 有毒有害物 . 或元素 | | | | |
| | 铅 (Pb) | 汞 (Hg) | 镉 (Cd) | 六价铬 (Cr6+) | 多溴联苯 (PBB) | 多溴二苯醚 (PBDE) |
| 金属部件 (Metal Parts) | ○ | ○ | ○ | x | ○ | ○ |
| 印刷板 . 件 (Printed Board Assemblies (PBA)) | x | ○ | ○ | ○ | ○ | ○ |

| Requirement | Country | Marking |
|---|---------|---|
| <p>○：表’有毒有害物。在。部件所有均。材料中的含量均在 SJ/T 11363-2006。准。定的限量要求以下。</p> <p>○： Indicates that this hazardous substance contained in all homogeneous materials of this part is below the limit requirement in SJ/T 11363-2006.</p> <p>×：表’有毒有害物。至少在。部件的某一均。材料中的含量超出 SJ/T 11363-2006。准。定的限量要求。</p> <p>×： Indicates that this hazardous substance contained in at least one of the homogeneous materials of this part is above the limit requirement in SJ/T 11363-2006.</p> <p>售之日的所售。品，本表’示我公司供..的。子信息。品可能’含。些物..。注意：在所售。品中可能’也可能’会含有所有所列的部件</p> <p>This table shows where these substances may be found in the supply chain of our electronic information products, as of the date of sale of the enclosed product. Note that some of the component types listed above may or may not be a part of the enclosed product.</p> | | |
| Belarus Safety Compliance Mark | Belarus |  |
| Waste of Electronic and Electrical Equipment Recycling Mark | Europe |  |
| China Restriction of Hazardous Substance Environmental Friendly Use Period Mark | China |  |
| China Recycling Mark | China |  |

| Requirement | Country | Marking |
|---|-----------------------------|---|
| Recycling Marks | International |   |
| Battery Perchlorate Warning Information | California | <p>Perchlorate Material - Special handling may apply. See www.dtsc.ca.gov/hazardouswaste/perchlorate</p> <p>This notice is required by California Code of Regulations, Title 22, Division 4.5, and Chapter 33: Best Management Practices for Perchlorate Materials. This product may include a battery which contains Perchlorate material.</p> |
| Safety | Multiple Power Cord Marking |  <p>This unit has more than one power supply cord. To reduce the risk of electrical shock, disconnect (2) two power supply cords before servicing.</p> <p>Simplified Chinese:</p> <p>注意： 本設備包括多條電源系統電纜。為避免遭受電擊，在進行維修之前應斷開兩（2）條電源系統電纜。</p> <p>Traditional Chinese:</p> <p>注意： 本設備包括多條電源系統電纜。為避免遭受電擊，在進行維修之前應斷開兩（2）條電源系統電纜。</p> <p>German:</p> <p>Dieses Geräte hat mehr als ein Stromkabel. Um eine Gefahr des elektrischen Schlages zu verringern trennen sie beide (2) Stromkabeln bevor Instandhaltung.</p> |

| Requirement | Country | Marking |
|------------------|------------------------------------|---|
| Nordic Countries | Connection to Proper Ground Outlet | <p>"WARNING:"</p> <p>"Apparaten skall anslutas till jordat uttag, när den ansluts till ett nätverk."</p> <p>"Laite on liitettävä suojamaadoituskoskettimilla varustettuun pistorasiaan."</p> <p>"Connect only to a properly earth grounded outlet."</p> |
| Safety | Standby-by power |  |

Regulated Specified Components

To maintain the UL listing and compliance to other regulatory certifications and/or declarations, the following regulated components must be used and conditions adhered to. Interchanging or use of other component will void the UL listing and other product certifications and approvals.

You can find updated product information for configurations on the Intel Server Builder Web site at the following URL:

<http://serverconfigurator.intel.com/default.aspx>

If you do not have access to Intel's Web address, contact your local Intel representative.

1. **Server Chassis:** Base chassis is provided with power supply and fans—UL listed.
2. **Server board:** You must use an Intel server board—UL recognized.
3. **Add-in Boards:** Must have a printed wiring board flammability rating of minimum UL94V-1. Add-in boards containing external power connectors and/or lithium batteries must be UL recognized or UL listed. Any add-in board containing modem telecommunication circuitry must be UL listed. In addition, the modem must have the appropriate telecommunications, safety, and EMC approvals for the region in which it is sold.
4. **Peripheral Storage Devices:** Must be UL recognized or UL listed accessory and TUV or VDE licensed. Maximum power rating of any one device is 19 watts. Total server configuration is not to exceed the maximum loading conditions of the power supply.

Electromagnetic Compatibility Notices

FCC Verification Statement (USA)

This device complies with Part 15 of the FCC Rules. Operation is subject to the following two conditions: (1) This device may not cause harmful interference, and (2) this device must accept any interference received, including interference that may cause undesired operation.

Intel Corporation
5200 N.E. Elam Young Parkway
Hillsboro, OR 97124-6497
Phone: 1-800-628-8686

This equipment has been tested and found to comply with the limits for a Class A digital device, pursuant to Part 15 of the FCC Rules. These limits are designed to provide reasonable protection against harmful interference in a residential installation. This equipment generates, uses, and can radiate radio frequency energy and, if not installed and used in accordance with the instructions, may cause harmful interference to radio communications. However, there is no guarantee that interference will not occur in a particular installation. If this equipment does cause harmful interference to radio or television reception, which can be determined by turning the equipment off and on, the user is encouraged to try to correct the interference by one or more of the following measures:

- Reorient or relocate the receiving antenna.
- Increase the separation between the equipment and the receiver.
- Connect the equipment into an outlet on a circuit different from that to which the receiver is connected.
- Consult the dealer or an experienced radio/TV technician for help.

Any changes or modifications not expressly approved by the grantee of this device could void the user's authority to operate the equipment. The customer is responsible for ensuring compliance of the modified product.

Only peripherals (computer input/output devices, terminals, printers, etc.) that comply with FCC Class A or B limits may be attached to this computer product. Operation with noncompliant peripherals is likely to result in interference to radio and TV reception.

All cables used to connect to peripherals must be shielded and grounded. Operation with cables, connected to peripherals that are not shielded and grounded may result in interference to radio and TV reception.

ICES-003 (Canada)

Cet appareil numérique respecte les limites bruits radioélectriques applicables aux appareils numériques de Classe A prescrites dans la norme sur le matériel brouilleur: "Appareils Numériques", NMB-003 édictée par le Ministre Canadian des Communications.

English translation of the notice above:

This digital apparatus does not exceed the Class A limits for radio noise emissions from digital apparatus set out in the interference-causing equipment standard entitled “Digital Apparatus,” ICES-003 of the Canadian Department of Communications.

Recycle battery in accordance with applicable WEEE and Battery laws.



Perchlorate Material - special handling may apply. See:

<http://www.dtsc.ca.gov/hazardouswaste/perchlorate>

This notice is required by California Code of Regulations, Title 22, Division 4.5, Chapter 33: Best Management Practices for Perchlorate Materials. This product/part includes a battery which contains perchlorate material.

Europe (CE Declaration of Conformity)

This product has been tested in accordance too, and complies with the Low Voltage Directive (73/23/EEC) and EMC Directive (89/336/EEC). The product has been marked with the CE Mark to illustrate its compliance.

Recycle battery in accordance with applicable WEEE and Battery laws.



Perchlorate Material - special handling may apply. See:

<http://www.dtsc.ca.gov/hazardouswaste/perchlorate>

This notice is required by California Code of Regulations, Title 22, Division 4.5, Chapter 33: Best Management Practices for Perchlorate Materials. This product/part includes a battery which contains perchlorate material.

VCCI (Japan)

この装置は、情報処理装置等電波障害自主規制協議会（VCCI）の基準に基づくクラス A 情報技術装置です。この装置を家庭環境で使用すると電波妨害を引き起こすことがあります。この場合には使用者が適切な対策を講ずるよう要求されることがあります。

English translation of the notice above:

This is a Class A product based on the standard of the Voluntary Control Council for Interference (VCCI) from Information Technology Equipment. If this is used near a radio or television receiver in a domestic environment, it may cause radio interference. Install and use the equipment according to the instruction manual.

Recycle battery in accordance with applicable WEEE and Battery laws.



Perchlorate Material - special handling may apply. See:

<http://www.dtsc.ca.gov/hazardouswaste/perchlorate>

This notice is required by California Code of Regulations, Title 22, Division 4.5, Chapter 33: Best Management Practices for Perchlorate Materials. This product/part includes a battery which contains perchlorate material.

BSMI (Taiwan)

The BSMI Certification Marking and EMC warning is located on the outside rear area of the product.

警告使用者：
這是甲類的資訊產品，在居住的環境中使用時，可能會造成射頻干擾，在這種情況下，使用者會被要求採取某些適當的對策

Recycle battery in accordance with applicable WEEE and Battery laws.







Perchlorate Material - special handling may apply. See:

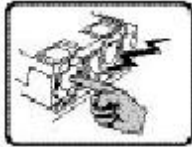

<http://www.dtsc.ca.gov/hazardouswaste/perchlorate>

This notice is required by California Code of Regulations, Title 22, Division 4.5, Chapter 33: Best Management Practices for Perchlorate Materials. This product/part includes a battery which contains perchlorate material.

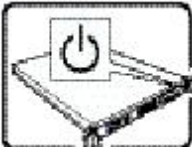

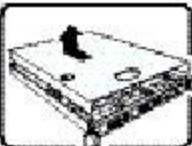

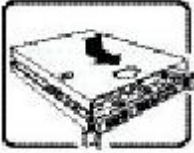
Appendix B: Installation/Assembly Safety Instructions

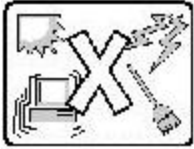
English

| | |
|---|--|
|  | <p>The power supply in this product contains no user-serviceable parts. Refer servicing only to qualified personnel.</p> |
|  | <p>Do not attempt to modify or use the supplied AC power cord if it is not the exact type required. A product with more than one power supply will have a separate AC power cord for each supply.</p> |
|  | <p>The power button on the compute module does not turn off system AC power. To remove AC power from the system, you must unplug each AC power cord from the wall outlet or power supply.</p> <p>The power cord(s) is considered the disconnect device to the main (AC) power. The socket outlet that the system plugs into shall be installed near the equipment and shall be easily accessible.</p> |
|  | <p>SAFETY STEPS: Whenever you remove the chassis covers to access the inside of the system, follow these steps:</p> <ol style="list-style-type: none"> 1. Turn off all peripheral devices connected to the system. 2. Turn off each compute module by pressing the power button. 3. Unplug all AC power cords from the system or from wall outlets. 4. Label and disconnect all cables connected to I/O connectors or ports on the back of the system. 5. Provide some electrostatic discharge (ESD) protection by wearing an antistatic wrist strap attached to chassis ground of the system-any unpainted metal surface-when handling components. 6. Do not operate the system with the chassis covers removed. |
|  | <p>After you have completed the six SAFETY steps above, you can remove the system covers. To do this:</p> <ol style="list-style-type: none"> 1. Unlock and remove the padlock from the back of the system if a padlock has been installed. 2. Remove and save all screws from the covers. 3. Remove the cover(s). |

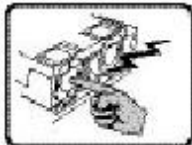
| | |
|---|---|
|  | <p>For proper cooling and airflow, always reinstall the chassis covers before turning on the system. Operating the system without the covers in place can damage system parts. To install the covers:</p> <ol style="list-style-type: none"> 1. Check first to make sure you have not left loose tools or parts inside the system. 2. Check that cables, add-in boards, and other components are properly installed. 3. Attach the covers to the chassis with the screws removed earlier, and tighten them firmly. 4. Insert and lock the padlock to the system to prevent unauthorized access inside the system. 5. Connect all external cables and the AC power cord(s) to the system. |
|  | <p>A microprocessor and heat sink may be hot if the system has been running. Also, there may be sharp pins and edges on some board and chassis parts. Contact should be made with care. Consider wearing protective gloves.</p> |
|  | <p>Danger of explosion if the battery is incorrectly replaced. Replace only with the same or equivalent type recommended by the equipment manufacturer. Dispose of used batteries according to manufacturer's instructions.</p> |
|  | <p>The system is designed to operate in a typical office environment. Choose a site that is:</p> <ul style="list-style-type: none"> • Clean and free of airborne particles (other than normal room dust). • Well ventilated and away from sources of heat including direct sunlight. • Away from sources of vibration or physical shock. • Isolated from strong electromagnetic fields produced by electrical devices. • In regions that are susceptible to electrical storms, we recommend you plug your system into a surge suppressor and disconnect telecommunication lines to your modem during an electrical storm. • Provided with a properly grounded wall outlet. • Provided with sufficient space to access the power supply cord(s), because they serve as the product's main power disconnect. |

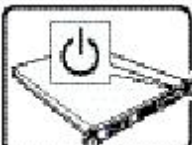
Deutsch

| | |
|---|--|
|  | <p>Benutzer können am Netzgerät dieses Produkts keine Reparaturen vornehmen. Das Produkt enthält möglicherweise mehrere Netzgeräte. Wartungsarbeiten müssen von qualifizierten Technikern ausgeführt werden.</p> |
|  | <p>Versuchen Sie nicht, das mitgelieferte Netzkabel zu ändern oder zu verwenden, wenn es sich nicht genau um den erforderlichen Typ handelt. Ein Produkt mit mehreren Netzgeräten hat für jedes Netzgerät ein eigenes Netzkabel.</p> |
|  | <p>Der Wechselstrom des Rechenmoduls wird durch den Ein-/Aus-Schalter für Gleichstrom nicht ausgeschaltet. Ziehen Sie alle Wechselstrom-Netzkabel aus der Steckdose bzw. dem Netzgerät, um den Stromanschluss des Systems zu unterbrechen.</p> <p>Die Stromkabel sind das "Unterbrechungsgerät" zur Hauptstromquelle. Die Steckdose, in die das System gesteckt wird, sollte sich in der Nähe des Gerätes befinden und leicht zugänglich sein.</p> |
|  | <p>SICHERHEITSMASSNAHMEN: Immer wenn Sie die Gehäuseabdeckung abnehmen um an das Systeminnere zu gelangen, sollten Sie folgende Schritte beachten:</p> <ol style="list-style-type: none">1. Schalten Sie alle an Ihr System angeschlossenen Peripheriegeräte aus.2. Schalten Sie das Rechenmodul mit dem Hauptschalter aus.3. Ziehen Sie den Stromanschlußstecker Ihres Systems aus der Steckdose.4. Auf der Rückseite des Systems beschrifteten und ziehen Sie alle Anschlußkabel von den I/O Anschlüssen oder Ports ab.5. Tragen Sie ein geerdetes Antistatik Gelenkband, um elektrostatische Ladungen (ESD) über blanke Metallstellen bei der Handhabung der Komponenten zu vermeiden.6. Schalten Sie das System niemals ohne ordnungsgemäß montiertes Gehäuse ein. |

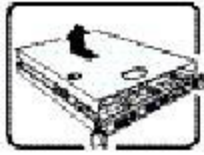

SICHERHEITSMASSNAHMEN: Immer wenn Sie die Gehäuseabdeckung abnehmen um an das Systeminnere zu gelangen, sollten Sie folgende Schritte beachten:

1. Schalten Sie alle an Ihr System angeschlossenen Peripheriegeräte aus.
2. Schalten Sie das System mit dem Hauptschalter aus.
3. Ziehen Sie den Stromanschlußstecker Ihres Systems aus der Steckdose.
4. Auf der Rückseite des Systems beschriften und ziehen Sie alle Anschlußkabel von den I/O Anschlüssen oder Ports ab.
5. Tragen Sie ein geerdetes Antistatik Gelenkband, um elektrostatische Ladungen (ESD) über blanke Metallstellen bei der Handhabung der Komponenten zu vermeiden.
6. Schalten Sie das System niemals ohne ordnungsgemäß montiertes Gehäuse ein.

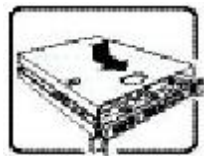

Zur ordnungsgemäßen Kühlung und Lüftung muß die Gehäuseabdeckung immer wieder vor dem Einschalten installiert werden. Ein Betrieb des Systems ohne angebrachte Abdeckung kann Ihrem System oder Teile darin beschädigen. Um die Abdeckung wieder anzubringen:

1. Vergewissern Sie sich, daß Sie keine Werkzeuge oder Teile im Innern des Systems zurückgelassen haben.
2. Überprüfen Sie alle Kabel, Zusatzkarten und andere Komponenten auf ordnungsgemäßen Sitz und Installation.
3. Bringen Sie die Abdeckungen wieder am Gehäuse an, indem Sie die zuvor gelösten Schrauben wieder anbringen. Ziehen Sie diese gut an.
4. Bringen Sie die Verschlusseinrichtung (Padlock) wieder an und schließen Sie diese, um ein unerlaubtes Öffnen des Systems zu verhindern.
5. Schließen Sie alle externen Kabel und den AC Stromanschlußstecker Ihres Systems wieder an.



Der Mikroprozessor und der Kühler sind möglicherweise erhitzt, wenn das System in Betrieb ist. Außerdem können einige Platinen und Gehäuseteile scharfe Spitzen und Kanten aufweisen. Arbeiten an Platinen und Gehäuse sollten vorsichtig ausgeführt werden. Sie sollten Schutzhandschuhe tragen.





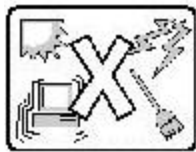



Bei falschem Einsetzen einer neuen Batterie besteht Explosionsgefahr. Die Batterie darf nur durch denselben oder einen entsprechenden, vom Hersteller empfohlenen Batterietyp ersetzt werden. Entsorgen Sie verbrauchte Batterien den Anweisungen des Herstellers entsprechend.

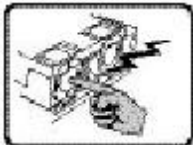

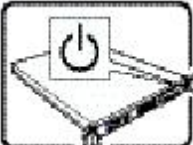

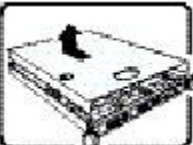

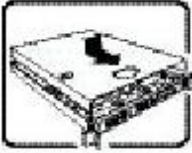
Das System wurde für den Betrieb in einer normalen Büroumgebung entwickelt. Der Standort sollte:

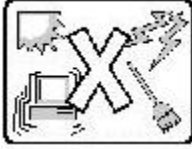
- "sauber und staubfrei sein (Hausstaub ausgenommen);
- "gut gelüftet und keinen Heizquellen ausgesetzt sein (einschließlich direkter Sonneneinstrahlung);
- "keinen Erschütterungen ausgesetzt sein;
- "keine starken, von elektrischen Geräten erzeugten elektromagnetischen Felder aufweisen;
- "in Regionen, in denen elektrische Stürme auftreten, mit einem Überspannungsschutzgerät verbunden sein; während eines elektrischen Sturms sollte keine Verbindung der Telekommunikationsleitungen mit dem Modem bestehen;
- "mit einer geerdeten Wechselstromsteckdose ausgerüstet sein;
- "über ausreichend Platz verfügen, um Zugang zu den Netzkabeln zu gewährleisten, da der Stromanschluß des Produkts hauptsächlich über die Kabel unterbrochen wird

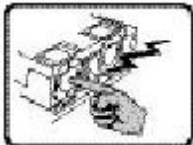
| | |
|---|--|
|  | <p>Le bloc d'alimentation de ce produit ne contient aucune pièce pouvant être réparée par l'utilisateur. Ce produit peut contenir plus d'un bloc d'alimentation. Veuillez contacter un technicien qualifié en cas de problème.</p> |
|  | <p>Ne pas essayer d'utiliser ni modifier le câble d'alimentation CA fourni, s'il ne correspond pas exactement au type requis. Le nombre de câbles d'alimentation CA fournis correspond au nombre de blocs d'alimentation du produit</p> |
|  | <p>Notez que le commutateur CC de mise sous tension/hors tension du module n'éteint pas l'alimentation CA du système. Pour mettre le système hors tension, vous devez débrancher chaque câble d'alimentation de sa prise.</p> <p>C'est le câble d'alimentation qui est considéré comme le moyen de se déconnecter du CA. La prise à laquelle le système est branché doit se situer à proximité de l'équipement et être facilement accessible.</p> |
|  | <p>CONSIGNES DE SÉCURITÉ -Lorsque vous ouvrez le boîtier pour accéder à l'intérieur du système, suivez les consignes suivantes:</p> <ol style="list-style-type: none"> 1. Mettez hors tension tous les périphériques connectés au système. 2. Mettez chaque module hors tension en mettant l'interrupteur en position OFF (bouton-poussoir). 3. Débranchez tous les cordons d'alimentation c.a. du système et des prises murales. 4. Identifiez et débranchez tous les câbles reliés aux connecteurs d'E-S ou aux accès derrière le système. 5. Pour prévenir les décharges électrostatiques lorsque vous touchez aux composants, portez une bande antistatique pour poignet et reliez-la à la masse du système (toute surface métallique non peinte du boîtier). 6. Ne faites pas fonctionner le système tandis que le boîtier est ouvert. |
|  | <p>Une fois TOUTES les étapes précédentes accomplies, vous pouvez retirer les panneaux du système. Procédez comme suit:</p> <ol style="list-style-type: none"> 1. Si un cadenas a été installé sur à l'arrière du système, déverrouillez-le et retirez-le. 2. Retirez toutes les vis des panneaux et mettez-les dans un endroit sûr. 3. Retirez les panneaux. |

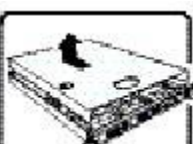
| | |
|---|---|
|  | <p>Afin de permettre le refroidissement et l'aération du système, réinstallez toujours les panneaux du boîtier avant de mettre le système sous tension. Le fonctionnement du système en l'absence des panneaux risque d'endommager ses pièces. Pour installer les panneaux, procédez comme suit:</p> <ol style="list-style-type: none"> 1. Assurez-vous de ne pas avoir oublié d'outils ou de pièces démontées dans le système. 2. Assurez-vous que les câbles, les cartes d'extension et les autres composants sont bien installés. 3. Revissez solidement les panneaux du boîtier avec les vis retirées plus tôt. 4. Remettez le cadenas en place et verrouillez-le afin de prévenir tout accès non autorisé à l'intérieur du système. 5. Rebranchez tous les cordons d'alimentation c. a. et câbles externes au système. |
|  | <p>Le microprocesseur et le dissipateur de chaleur peuvent être chauds si le système a été sous tension. Faites également attention aux broches aiguës des cartes et aux bords tranchants du capot. Nous vous recommandons l'usage de gants de protection.</p> |
|  | <p>Danger d'explosion si la batterie n'est pas remontée correctement. Remplacer uniquement avec une batterie du même type ou d'un type équivalent recommandé par le fabricant. Disposez des piles usées selon les instructions du fabricant.</p> |
|  | <p>Le système a été conçu pour fonctionner dans un cadre de travail normal. L'emplacement choisi doit être:</p> <ul style="list-style-type: none"> • "Propre et dépourvu de poussière en suspension (sauf la poussière normale). • "Bien aéré et loin des sources de chaleur, y compris du soleil direct. • "A l'abri des chocs et des sources de vibrations. • "Isolé de forts champs électromagnétiques géenérés par des appareils électriques. • "Dans les régions sujettes aux orages magnétiques il est recommandé de brancher votre système à un supresseur de surtension, et de débrancher toutes les lignes de télécommunications de votre modem durant un orage. • "Muni d'une prise murale correctement mise à la terre. • "Suffisamment spacieux pour vous permettre d'accéder aux câbles d'alimentation (ceux-ci étant le seul moyen de mettre le système hors tension). |

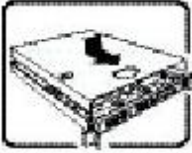
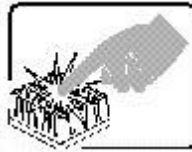
| | |
|---|--|
|  | <p>El usuario debe abstenerse de manipular los componentes de la fuente de alimentación de este producto, cuya reparación debe dejarse exclusivamente en manos de personal técnico especializado. Puede que este producto disponga de más de una fuente de alimentación</p> |
|  | <p>No intente modificar ni usar el cable de alimentación de corriente alterna, si no corresponde exactamente con el tipo requerido. El número de cables suministrados se corresponden con el número de fuentes de alimentación de corriente alterna que tenga el producto</p> |
|  | <p>Nótese que el interruptor activado/desactivado en el panel frontal no desconecta la corriente alterna del módulo de computación. Para desconectarla, deberá desenchufar todos los cables de corriente alterna de la pared o desconectar la fuente de alimentación. Estos cables actúan como dispositivo de desconexión. La toma de corriente deberá estar situada cerca del equipo y ser de fácil acceso.</p> |
|  | <p>INSTRUCCIONES DE SEGURIDAD: Cuando extraiga la tapa del chasis para acceder al interior del sistema, siga las siguientes instrucciones:</p> <ol style="list-style-type: none"> 1. Apague todos los dispositivos periféricos conectados al sistema. 2. Apague el módulo de computación presionando el interruptor encendido/ apagado. 3. Desconecte todos los cables de alimentación CA del sistema o de las tomas de corriente alterna. 4. Identifique y desconecte todos los cables enchufados a los conectores E/S o a los puertos situados en la parte posterior del sistema. 5. Cuando manipule los componentes, es importante protegerse contra la descarga electrostática (ESD). Puede hacerlo si utiliza una muñequera antiestática sujeta a la toma de tierra del chasis - o a cualquier tipo de superficie de metal sin pintar. 6. No ponga en marcha el sistema si se han extraído las tapas del chasis. |
|  | <p>Después de completar las seis instrucciones de SEGURIDAD mencionadas, ya puede extraer las tapas del sistema. Para ello:</p> <ol style="list-style-type: none"> 1. Desbloquee y extraiga el bloqueo de seguridad de la parte posterior del sistema, si se ha instalado uno. 2. Extraiga y guarde todos los tornillos de las tapas. Extraiga las tapas. |

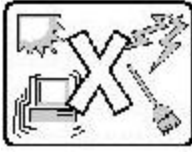
| | |
|---|---|
|  | <p>Para obtener un enfriamiento y un flujo de aire adecuados, reinstale siempre las tapas del chasis antes de poner en marcha el sistema. Si pone en funcionamiento el sistema sin las tapas bien colocadas puede dañar los componentes del sistema. Para instalar las tapas:</p> <ol style="list-style-type: none"> 1. Asegúrese primero de no haber dejado herramientas o componentes sueltos dentro del sistema. 2. Compruebe que los cables, las placas adicionales y otros componentes se hayan instalado correctamente. 3. Incorpore las tapas al chasis mediante los tornillos extraídos anteriormente, tensándolos firmemente. 4. Inserte el bloqueo de seguridad en el sistema y bloquéelo para impedir que pueda accederse al mismo sin autorización. 5. Conecte todos los cables externos y los cables de alimentación CA al sistema. |
|  | <p>Si el sistema ha estado en funcionamiento, el microprocesador y el disipador de calor pueden estar aún calientes. También conviene tener en cuenta que en el chasis o en el tablero puede haber piezas cortantes o punzantes. Por ello, se recomienda precaución y el uso de guantes protectores.</p> |
|  | <p>Existe peligro de explosión si la pila no se cambia de forma adecuada. Utilice solamente pilas iguales o del mismo tipo que las recomendadas por el fabricante del equipo. Para deshacerse de las pilas usadas, siga igualmente las instrucciones del fabricante.</p> |
|  | <p>El sistema está diseñado para funcionar en un entorno de trabajo normal. Escoja un lugar:</p> <ul style="list-style-type: none"> • "Limpio y libre de partículas en suspensión (salvo el polvo normal). • "Bien ventilado y alejado de fuentes de calor, incluida la luz solar directa. • "Alejado de fuentes de vibración. • "Aislado de campos electromagnéticos fuertes producidos por dispositivos eléctricos. • "En regiones con frecuentes tormentas eléctricas, se recomienda conectar su sistema a un eliminador de sobrevoltage y desconectar el módem de las líneas de telecomunicación durante las tormentas. • "Provisto de una toma de tierra correctamente instalada. • "Provisto de espacio suficiente como para acceder a los cables de alimentación, ya que éstos hacen de medio principal de desconexión del sistema. |

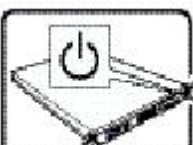
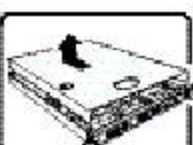
| | |
|---|--|
|  | <p>Rivolgersi ad un tecnico specializzato per la riparazione dei componenti dell'alimentazione di questo prodotto. È possibile che il prodotto disponga di più fonti di alimentazione.</p> |
|  | <p>Non modificare o utilizzare il cavo di alimentazione in c.a. fornito dal produttore, se non corrisponde esattamente al tipo richiesto. Ad ogni fonte di alimentazione corrisponde un cavo di alimentazione in c.a. separato</p> |
|  | <p>Il pulsante non interrompe l'alimentazione in c.a. del modulo. Per interromperla, è necessario scollegare tutti i cavi di alimentazione in c.a. dalle prese a muro o dall'alimentazione di corrente.</p> <p>Il cavo è considerato il dispositivo d'interruzione dell'alimentazione principale (in c.a.). La presa alla quale si collega il sistema deve essere installata vicino all'unità e deve essere facilmente accessibile.</p> |
|  | <p>PASSI DI SICUREZZA: Qualora si rimuovano le coperture del telaio per accedere all'interno del sistema, seguire i seguenti passi:</p> <ol style="list-style-type: none"> 1. Spegnerne tutti i dispositivi periferici collegati al sistema. 2. Spegnerne ciascun modulo usando il pulsante di alimentazione. 3. Togliere tutte le spine dei cavi del sistema dalle prese elettriche. 4. Identificare e sconnettere tutti i cavi attaccati ai collegamenti I/O od alle prese installate sul retro del sistema. 5. Qualora si tocchino i componenti, proteggersi dallo scarico elettrostatico (SES), portando un cinghia anti-statica da polso che è attaccata alla presa a terra del telaio del sistema - qualsiasi superficie non dipinta - . 6. Non far operare il sistema quando il telaio è senza le coperture. |
|  | <p>Dopo aver seguito i sei passi di SICUREZZA sopracitati, togliere le coperture del telaio del sistema come segue:</p> <ol style="list-style-type: none"> 1. Aprire e rimuovere il lucchetto dal retro del sistema qualora ve ne fosse uno installato. 2. Togliere e mettere in un posto sicuro tutte le viti delle coperture. 3. Togliere le coperture. |

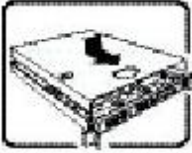
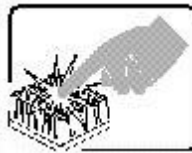
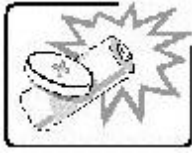
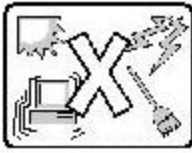
| | |
|---|--|
|  | <p>Per il giusto flusso dell'aria e raffreddamento del sistema, rimettere sempre le coperture del telaio prima di riaccendere il sistema. Operare il sistema senza le coperture al loro proprio posto potrebbe danneggiare i componenti del sistema. Per rimettere le coperture del telaio:</p> <ol style="list-style-type: none"> 1. Controllare prima che non si siano lasciati degli attrezzi o dei componenti dentro il sistema. 2. Controllare che i cavi, dei supporti aggiuntivi ed altri componenti siano stati installati appropriatamente. 3. Attaccare le coperture al telaio con le viti tolte in precedenza e avvitarle strettamente. 4. Inserire e chiudere a chiave il lucchetto sul retro del sistema per impedire l'accesso non autorizzato al sistema. 5. Ricollegare tutti i cavi esterni e le prolunghe AC del sistema. |
|  | <p>Se il sistema è stato a lungo in funzione, il microprocessore e il dissipatore di calore potrebbero essere surriscaldati. Fare attenzione alla presenza di piedini appuntiti e parti taglienti sulle schede e sul telaio. È consigliabile l'uso di guanti di protezione.</p> |
|  | <p>Esiste il pericolo di un'esplosione se la pila non viene sostituita in modo corretto. Utilizzare solo pile uguali o di tipo equivalente a quelle consigliate dal produttore. Per disfarsi delle pile usate, seguire le istruzioni del produttore.</p> |
|  | <p>Il sistema è progettato per funzionare in un ambiente di lavoro tipo. Scegliere una postazione che sia:</p> <ul style="list-style-type: none"> • "Pulita e libera da particelle in sospensione (a parte la normale polvere presente nell'ambiente). • "Ben ventilata e lontana da fonti di calore, compresa la luce solare diretta. • "Al riparo da urti e lontana da fonti di vibrazione. • "Isolata dai forti campi magnetici prodotti da dispositivi elettrici. • "In aree soggette a temporali, è consigliabile collegare il sistema ad un limitatore di corrente. In caso di temporali, scollegare le linee di comunicazione dal modem. • "Dotata di una presa a muro correttamente installata. • "Dotata di spazio sufficiente ad accedere ai cavi di alimentazione, i quali rappresentano il mezzo principale di scollegamento del sistema. |

Appendix C: Safety Information

English

Server Safety Information

This document applies to Intel® server boards, Intel® server chassis and installed peripherals. To reduce the risk of bodily injury, electrical shock, fire, and equipment damage, read this document and observe all warnings and precautions in this guide before installing or maintaining your Intel® server product.



In the event of a conflict between the information in this document and information provided with the product or on the website for a particular product, the product documentation takes precedence.





Your server should be integrated and serviced only by technically qualified persons.

You must adhere to the guidelines in this guide and the assembly instructions in your server manuals to ensure and maintain compliance with existing product certifications and approvals. Use only the described, regulated components specified in this guide. Use of other products/components will void the UL Listing and other regulatory approvals of the product, and may result in noncompliance with product regulations in the region(s) in which the product is sold.

Safety Warnings and Cautions

To avoid personal injury or property damage, before you begin installing the product, read, observe, and adhere to all of the following safety instructions and information. The following safety symbols may be used throughout the documentation and may be marked on the product and/or the product packaging.

| | |
|---|---|
| CAUTION | Indicates the presence of a hazard that may cause minor personal injury or property damage if the CAUTION is ignored. |
| WARNING | Indicates the presence of a hazard that may result in serious personal injury if the WARNING is ignored. |
|  | Indicates potential hazard if indicated information is ignored. |
|  | Indicates shock hazards that result in serious injury or death if safety instructions are not followed. |

| | |
|---|---|
|  | Indicates hot components or surfaces. |
|  | Indicates do not touch fan blades, may result in injury. |
|  | Indicates to unplug all AC power cord(s) to disconnect AC power |
|  | Please recycle battery |

Intended Application Uses

This product was evaluated as Information Technology Equipment (ITE), which may be installed in offices, schools, computer rooms, and similar commercial type locations. The suitability of this product for other product categories and environments (such as medical, industrial, residential, alarm systems, and test equipment), other than an ITE application, may require further evaluation.

Site Selection

The compute module is designed to operate in a typical office environment. Choose a site that is:

- Clean, dry, and free of airborne particles (other than normal room dust).
- Well-ventilated and away from sources of heat including direct sunlight and radiators.
- Away from sources of vibration or physical shock.
- Isolated from strong electromagnetic fields produced by electrical devices.
- In regions that are susceptible to electrical storms, we recommend you plug your compute module into a surge suppressor and disconnect telecommunication lines to your modem during an electrical storm.
- Provided with a properly grounded wall outlet.
- Provided with sufficient space to access the power supply cord(s), because they serve as the product's main power disconnect.

Equipment Handling Practices

Reduce the risk of personal injury or equipment damage:

- Conform to local occupational health and safety requirements when moving and lifting equipment.

- Use mechanical assistance or other suitable assistance when moving and lifting equipment.
- To reduce the weight for easier handling, remove any easily detachable components.

Power and Electrical Warnings

Caution: *The power button, indicated by the stand-by power marking, DOES NOT completely turn off the compute module AC power, 5V standby power is active whenever the compute module is plugged in. To remove power from compute module, you must unplug the AC power cord from the wall outlet. Your compute module may use more than one AC power cord. Make sure all AC power cords are unplugged. Make sure the AC power cord(s) is/are unplugged before you open the chassis, or add or remove any non hot-plug components.*

Do not attempt to modify or use an AC power cord if it is not the exact type required. A separate AC cord is required for each compute module power supply.

Some power supplies in Intel® servers use Neutral Pole Fusing. To avoid risk of shock use caution when working with power supplies that use Neutral Pole Fusing.

The power supply in this product contains no user-serviceable parts. Do not open the power supply. Hazardous voltage, current and energy levels are present inside the power supply. Return to manufacturer for servicing.

When replacing a hot-plug power supply, unplug the power cord to the power supply being replaced before removing it from the server.

To avoid risk of electric shock, turn off the server and disconnect the power cord, telecommunications systems, networks, and modems attached to the server before opening it.

Access Warnings

Caution: *To avoid personal injury or property damage, the following safety instructions apply whenever accessing the inside of the product:*

- *Turn off all peripheral devices connected to this product.*
- *Turn off the compute module by pressing the power button off.*
- *Disconnect the AC power by unplugging all AC power cords from the chassis or wall outlet.*
- *Disconnect all cables and telecommunication lines that are connected to the compute module.*
- *Retain all screws or other fasteners when removing access cover(s). Upon completion of accessing inside the product, refasten access cover with original screws or fasteners.*
- *Do not access the inside of the power supply. There are no serviceable parts in the power supply. Return to manufacturer for servicing.*
- *Power down the chassis and disconnect all power cords before adding or replacing any non hot-plug component.*

- *When replacing a hot-plug power supply, unplug the power cord to the power supply being replaced before removing the power supply from the chassis.*

Caution: *If the compute module has been running, any installed processor(s) and heat sink(s) may be hot. Unless you are adding or removing a hot-plug component, allow the compute module to cool before opening the covers. To avoid the possibility of coming into contact with hot component(s) during a hot-plug installation, be careful when removing or installing the hot-plug component(s).*

Caution: *To avoid injury do not contact moving fan blades. If your chassis is supplied with a guard over the fan, do not operate the chassis without the fan guard in place.*

Electrostatic Discharge (ESD)

Caution: *ESD can damage disk drives, boards, and other parts. We recommend that you perform all procedures at an ESD workstation. If one is not available, provide some ESD protection by wearing an antistatic wrist strap attached to chassis ground -- any unpainted metal surface -- on your server when handling parts.*

Always handle boards carefully. They can be extremely sensitive to ESD. Hold boards only by their edges. After removing a board from its protective wrapper or from the server, place the board component side up on a grounded, static free surface. Use a conductive foam pad if available but not the board wrapper. Do not slide board over any surface.

Other Hazards

Battery Replacement

Caution: *There is the danger of explosion if the battery is incorrectly replaced. When replacing the battery, use only the battery recommended by the equipment manufacturer.*

Dispose of batteries according to local ordinances and regulations.

Do not attempt to recharge a battery.

Do not attempt to disassemble, puncture, or otherwise damage a battery.

Cooling and Airflow

Caution: *Carefully route cables as directed to minimize airflow blockage and cooling problems.*

For proper cooling and airflow, operate the chassis only with the chassis covers installed. Operating the chassis without the covers in place can damage chassis parts. To install the covers:

- *Check first to make sure you have not left loose tools or parts inside the chassis*
- *Check that cables, add-in boards, and other components are properly installed.*
- *Attach the covers to the chassis according to the product instructions.*

Laser Peripherals or Devices

Caution: *To avoid risk of radiation exposure and/or personal injury:*

- *Do not open the enclosure of any laser peripheral or device*
- *Laser peripherals or devices have are not user serviceable*
- *Return to manufacturer for servicing*

Deutsch

Sicherheitshinweise für den Server

Das vorliegende Dokument bezieht sich auf Intel® Serverplatinen, Intel® Servergehäuse (Standfuß und Rack) sowie installierte Peripheriegeräte. Es enthält Warnungen und Vorsichtsmaßnahmen zur Vermeidung von Gefahren durch Verletzung, Stromschlag, Feuer und Beschädigungen von Geräten. Lesen Sie diese Dokument daher sorgfältig, bevor Sie Ihr Intel® Serverprodukt installieren oder warten.

Bei Widersprüchen zwischen den hier vorliegenden Angaben und den Informationen im Lieferumfang des Produkts oder auf der Website des betreffenden Produkts hat die Produktdokumentation Vorrang.







Die Integration und Wartung des Servers darf nur durch technisch qualifizierte Personen erfolgen.

Um die Einhaltung der vorhandenen Zulassungen und Genehmigungen für das Produkt zu gewährleisten, sind die Richtlinien in diesem Handbuch sowie die Montageanleitungen in den Serverhandbüchern zu beachten. Verwenden Sie nur die beschriebenen, zugelassenen Komponenten, die im vorliegenden Handbuch angegeben werden. Die Verwendung anderer Produkte oder Komponenten führt zum Erlöschen der UL-Zulassung und anderer Genehmigungen für das Produkt. Dadurch kann das Produkt gegen Produktbestimmungen verstoßen, die im Verkaufsland gelten.

Sicherheitshinweise und Vorsichtsmaßnahmen

Um Verletzungen und Beschädigungen zu vermeiden, sollten Sie vor dem Beginn der Produktinstallation die nachfolgend aufgeführten Sicherheitshinweise und -informationen sorgfältig lesen und befolgen. In dem vorliegenden Handbuch sowie auf dem Produkt und auf der Verpackung werden folgende Sicherheitssymbole verwendet:

| | |
|-----------------|--|
| VORSICHT | Weist auf eine Gefahrenquelle hin, die bei Nichtbeachtung des VORSICHTSHINWEISES zu leichteren Verletzungen bzw. Sachbeschädigungen führen kann. |
| WARNUNG | Weist auf eine Gefahrenquelle hin, die bei Nichtbeachtung der WARNUNG zu ernstesten Verletzungen führen kann. |

| | |
|---|--|
|  | Weist auf potentielle Gefahr bei Nichtbeachtung der angezeigten Informationen hin. |
|  | Weist auf die Gefahr eines Stromschlags hin, der bei Nichtbeachtung der Sicherheitshinweise zu schweren oder tödlichen Verletzungen führen kann. |
|  | Weist auf Verbrennungsgefahr an heißen Bauteilen bzw. Oberflächen hin. |
|  | Weist darauf hin, daß das Anfassen des Gebläses zu Verletzungen führen kann. |
|  | Bedeutet, alle Netzkabel abzuziehen und das Gerät von der Netzspannung zu trennen. |
|  | Bereiten Sie bitte Batterie auf |

Zielbenutzer der Anwendung

Dieses Produkt wurde in seiner Eigenschaft als IT-Gerät getestet, das in Büros, Schulen, Computerräumen und ähnlichen öffentlichen Räumlichkeiten installiert werden kann. Die Eignung dieses Produkts für andere Einsatzbereiche als IT (z. B. Medizin, Industrie, Alarmsysteme oder Prüfgeräte) kann u. U. weitere Tests erfordern.

Standortauswahl

Das System ist für den Betrieb innerhalb normaler Büroumgebungen geeignet. Wählen Sie einen Standort, der folgenden Kriterien entspricht:

- Sauber, trocken und frei von Partikeln in der Luft (außer dem normalen Raumstaub).
- Gut belüftet, nicht in der Nähe von Wärmequellen und keiner direkten Sonnenbestrahlung ausgesetzt.
- Nicht in der Nähe von Vibrations- oder Erschütterungsquellen.
- Abgeschirmt von starken elektromagnetischen Feldern, die durch elektrische Geräte erzeugt werden.
- In gewittergefährdeten Gebieten sollten Sie das System an einen Überspannungsschutz anschließen und bei einem Gewitter die Telekommunikationskabel zum Modem abziehen.
- Eine ordnungsgemäß geerdete Wandsteckdose muß vorhanden sein.
- Ausreichender Freiraum für den Zugang zu den Netzkabeln, da diese die Hauptvorrichtung zum Trennen des Produkts von der Stromversorgung sind.

Handhabung von Geräten

Beachten Sie zur Vermeidung von Verletzungen oder Beschädigungen an den Geräten die folgenden Hinweise:

- Halten Sie beim Transportieren und Anheben von Geräten die örtlichen Gesundheits- und Sicherheitsvorschriften ein.
- Verwenden Sie mechanische oder andere geeignete Hilfsmittel zum Transportieren oder Anheben von Geräten.
- Entfernen Sie alle Komponenten, die sich leicht abnehmen lassen, um das Gewicht zu reduzieren und die Handhabung zu erleichtern.

Warnungen zu Netzspannung und Elektrizität

Vorsicht: Durch Betätigen der mit dem Standby-Symbol gekennzeichneten Netztaaste wird das System NICHT vollständig vom Netz getrennt. Es sind weiterhin 5 V aktiv, solange das System eingesteckt ist. Um das System vollständig vom Strom zu trennen, muß das Netzkabel aus der Steckdose abgezogen werden. Das System verfügt möglicherweise über mehrere Netzkabel. Vergewissern Sie sich in diesem Fall, daß alle Netzkabel abgezogen sind. Wenn Sie Komponenten ein- oder ausbauen möchten, die nicht hot-plug-fähig sind, stellen Sie sicher, daß zuvor alle Netzkabel abgezogen sind.

Nehmen Sie keine Änderungen am Netzkabel vor, und verwenden Sie kein Kabel, das nicht genau dem geforderten Typ entspricht. Jedes Netzteil im System muß über ein eigenes Netzkabel angeschlossen werden.

Einige Netzteile von Intel Servern verwenden Nullleitersicherungen. Vorsicht ist geboten im Umgang mit Netzteilen, welche Nullleitersicherungen verwenden, um das Risiko eines elektrischen Schlages zu vermeiden

Das Netzteil in diesem Produkt enthält keine Teile, die vom Benutzer gewartet werden können. Öffnen Sie das Netzteil nicht. Im Netzteil bestehen gefährliche Spannungen, Ströme und Energiequellen. Schicken Sie das Gerät für Wartungsarbeiten an den Hersteller zurück.

Wenn Sie ein hot-plug-fähiges Netzteil austauschen, ziehen Sie dessen Netzkabel ab, bevor Sie es aus dem Server ausbauen.

Zur Vermeidung von Stromschlägen schalten Sie den Server aus, und trennen Sie vor dem Öffnen des Geräts das Netzkabel sowie alle an den Server angeschlossene Telekommunikationssysteme, Netzwerke und Modems.

Warnhinweise für den Systemzugang

Vorsicht: Um Verletzungen und Beschädigungen zu vermeiden, sollten Sie vor Arbeiten im Produktinneren folgende Sicherheitsanweisungen beachten:

- Schalten Sie alle am Produkt angeschlossenen Peripheriegeräte aus.
- Schalten Sie das System mit dem Netzschalter aus.
- Trennen Sie das Gerät von der Stromquelle, indem Sie alle Netzkabel vom System bzw. aus der Steckdose ziehen.
- Ziehen Sie alle Kabel und alle an das System angeschlossenen Telekommunikationsleitungen ab.
- Bewahren Sie alle Schrauben und anderen Befestigungselemente gut auf, nachdem Sie die Gehäuseabdeckung entfernt haben. Wenn Sie Ihre Arbeiten im Systeminneren beendet haben, befestigen Sie die Gehäuseabdeckung mit den Originalschrauben bzw. -befestigungselementen.
- Führen Sie keine Arbeiten im Netzteil aus. Das Netzteil enthält keine für den Benutzer wartungsbedürftigen Teile. Schicken Sie das Gerät für Wartungsarbeiten an den Hersteller zurück.
- Schalten Sie den Server aus, und ziehen Sie alle Netzkabel ab, bevor Sie Komponenten ein- oder ausbauen, die nicht hot-plug-fähig sind.

- *Wenn Sie ein hot-plug-fähiges Netzteil austauschen, ziehen Sie dessen Netzkabel ab, bevor Sie es aus dem Server ausbauen.*

Vorsicht: *War Ihr Server in Betrieb, können die installierten Prozessoren und Kühlkörper heiß sein. Sofern Sie keine Hot-Plug-Komponenten ein- oder ausbauen, warten Sie mit dem Abnehmen der Abdeckungen, bis das System abgekühlt ist. Gehen Sie beim Aus- oder Einbauen von Hot-Plug-Komponenten sorgfältig vor, um nicht mit heißen Komponenten in Berührung zu kommen.*

Vorsicht: *Berühren Sie nicht die rotierenden Lüfterflügel, um Verletzungen zu vermeiden. Falls Ihr System mit einer Lüfterabdeckung besitzt, darf es nicht ohne diese Abdeckung betrieben werden.*

Elektrostatische Entladungen (ESD)

Vorsicht: *Elektrostatische Entladungen können zur Beschädigung von Festplatten, Platinen und anderen Komponenten führen. Daher sollten Sie alle Arbeiten an einer ESD-Workstation ausführen. Steht ein solcher Arbeitsplatz nicht zur Verfügung, erzielen Sie einen gewissen Schutz vor elektrostatischen Entladungen durch Tragen einer Antistatik-Manschette, die Sie während der Arbeit zur Erdung an einem beliebigen unlackierten Metallteil des Computergehäuses befestigen.*

Gehen Sie bei der Handhabung von Platinen immer mit größter Vorsicht vor. Sie können äußerst empfindlich gegenüber elektrostatischer Entladung sein. Halten Sie Platinen nur an den Kanten fest. Legen Sie die Platinen nach dem Auspacken aus der Schutzhülle oder nach dem Ausbau aus dem Server mit der Bauelementseite nach oben auf eine geerdete, statisch entladene Unterlage. Verwenden Sie dazu, sofern verfügbar, eine leitfähige Schaumstoffunterlage, aber nicht die Schutzhülle der Platine. Ziehen Sie die Platine nicht über eine Fläche.

Andere Gefahren

Batterieaustausch

Vorsicht: Wird die Batterie unsachgemäß ausgetauscht, besteht Explosionsgefahr. Verwenden Sie als Ersatz nur die vom Gerätehersteller empfohlene Batterie.

Beachten Sie bei der Entsorgung von Batterien die gültigen Bestimmungen.

Versuchen Sie nicht, eine Batterie aufzuladen.

Versuchen Sie nicht, eine Batterie zu öffnen oder sonstwie zu beschädigen.

Kühlung und Luftstrom

Vorsicht: Verlegen Sie Kabel sorgfältig entsprechend der Anleitung, um Störungen des Luftstroms und Kühlungsprobleme zu vermeiden.

Zur Gewährleistung des ordnungsgemäßen Kühlungs- und Luftstromverhaltens darf das System nur mit angebrachten Gehäuseabdeckungen betrieben werden. Die Inbetriebnahme des Systems ohne Abdeckung kann zur Beschädigung von Systemkomponenten führen. So bringen Sie die Abdeckung wieder an:

- Vergewissern Sie sich zunächst, daß Sie keine Werkzeuge oder Teile im Gehäuse vergessen haben.
- Prüfen Sie, ob Kabel, Erweiterungskarten sowie weitere Komponenten ordnungsgemäß angebracht sind.
- Befestigen Sie die Abdeckungen am Gehäuse des Produkts, wie in dessen Anleitung beschrieben.

Laser-Peripheriegeräte oder -Komponenten

Vorsicht: Beachten Sie zur Vermeidung von Strahlung und Verletzungen die folgenden Hinweise:

- Öffnen Sie keinesfalls das Gehäuse von Laser-Peripheriegeräten oder Laser-Komponenten.
- Laser-Peripheriegeräte oder -Komponenten besitzen keine für den Benutzer wartungsbedürftigen Teile.
- Schicken Sie das Gerät für Wartungsarbeiten an den Hersteller zurück.

Français

Consignes de sécurité sur le serveur

Ce document s'applique aux cartes serveur Intel[®], au châssis de serveur Intel[®] (sur pieds et sur rack) et aux périphériques installés. Pour réduire les risques de dommages corporels, d'électrocution, d'incendie et de dommages matériels, lisez ce document et respectez tous les avertissements et précautions mentionnés dans ce guide avant d'installer ou de mettre à jour votre produit serveur Intel[®].





En cas de conflit entre les informations fournies dans ce document et celles livrées avec le produit ou publiées sur le site Web pour un produit particulier, la documentation du produit prime.

Votre serveur doit être intégré et entretenu uniquement par des techniciens qualifiés.

Vous devez suivre les informations de ce guide et les instructions d'assemblage des manuels de serveur pour vérifier et maintenir la conformité avec les certifications et approbations de produit existantes. Utilisez uniquement les composants décrits et réglementés spécifiés dans ce guide. L'utilisation d'autres produits/composants annulera la liste UL et les autres approbations réglementaires du produit, et le produit peut ne pas être conforme aux autres lois et réglementations locales applicables au produit.

Sécurité: avertissements et mises en garde

Pour éviter de vous blesser ou d'endommager votre équipement, lisez et respectez toutes les informations et consignes de sécurité avant de commencer l'installation du produit. Les symboles de sécurité suivants peuvent être utilisés tout au long de cette documentation et peuvent figurer sur le produit ou sur son emballage.

| | |
|---|--|
| ATTENTION | Indique la présence d'un risque pouvant entraîner des blessures physiques mineures ou endommager légèrement le matériel si la mise en garde n'est pas prise en compte. |
| AVERTISSEMENT | Indique la présence d'un risque pouvant entraîner des blessures corporelles graves si l'avertissement n'est pas pris en compte. |
|  | Indique un risque potentiel si les informations signalées ne sont pas prises en compte. |
|  | Indique des risques d'électrocution pouvant entraîner des blessures corporelles graves ou mortelles si les consignes de sécurité ne sont pas respectées. |
|  | Signale des composants ou des surfaces soumis à des températures élevées. |
|  | Indique de ne pas toucher aux pales de ventilateur, car cela peut entraîner des blessures. |



Indique de débrancher tous les cordons d'alimentation secteur pour déconnecter l'alimentation.



Veillez réutiliser la batterie

Domaines d'utilisation prévus

Ce produit a été testé comme équipement informatique (ITE) et peut être installé dans des bureaux, des écoles, des salles informatiques et des endroits commerciaux similaires. L'utilisation du présent produit dans des catégories et environnements de produits et domaines d'application (par exemple, le domaine médical, industriel, résidentiel, les systèmes d'alarme et les appareils de contrôle) autres qu'ITE doit faire l'objet d'évaluations supplémentaires.

Sélection d'un emplacement

Le système est conçu pour fonctionner dans un environnement standard de bureau. Choisissez un emplacement respectant les conditions suivantes :

- Propre, sec et exempt de particules en suspension (autres que la poussière normale d'une pièce).
- Bien ventilé et à l'écart des sources de chaleur telles que la lumière directe du soleil et les radiateurs.
- À l'écart des sources de vibration ou des chocs physiques.
- Isolé des champs électromagnétiques importants produits par des appareils électriques.
- Dans les régions sujettes aux orages magnétiques, nous vous recommandons de brancher votre système à un suppresseur de surtension et de déconnecter les lignes de télécommunication de votre modem pendant les orages.
- Équipé d'une prise murale reliée à la terre.
- Équipé d'un espace suffisant pour accéder aux cordons d'alimentation secteur, car ils servent de disjoncteur principal d'alimentation du produit.

Pratiques de manipulation de l'équipement

Réduisez le risque de dommages personnels ou matériels :

- Conformez-vous aux exigences de médecine du travail et de sécurité lorsque vous déplacez et soulevez le matériel.
- Utilisez l'assistance mécanique ou toute autre assistance appropriée lorsque vous déplacez et soulevez le matériel.
- Pour réduire le poids en vue de faciliter la manipulation, retirez tout composant amovible.

Alimentation et avertissements en matière d'électricité

Attention: Le bouton d'alimentation, indiqué par le symbole de mise en veille, NE COUPE PAS complètement l'alimentation secteur du système car le courant de veille 5 V reste actif lorsque le système est sous tension. Pour couper l'alimentation du système, vous devez débrancher le cordon d'alimentation secteur de la prise murale. Votre système peut utiliser plusieurs cordons d'alimentation secteur. Assurez-vous que tous les cordons d'alimentation sont débranchés. Vous devez les débrancher avant d'ouvrir le châssis, d'ajouter ou de supprimer un composant non connectable à chaud.

Les alimentations de certains serveurs Intel sont munies de doubles fusibles pôle/neutre: veuillez observer les précautions d'usage afin d'éviter tout risque d'électrocution.

N'essayez pas de modifier ou d'utiliser un cordon d'alimentation secteur s'il ne s'agit pas du type exact requis. Un cordon secteur est requis pour chaque alimentation système.

Le bloc d'alimentation de ce produit ne contient aucun composant réparable par l'utilisateur. N'ouvrez pas le bloc d'alimentation. L'intérieur de celui-ci est soumis à des niveaux dangereux de tension, de courant et d'énergie. Renvoyez-le au fabricant en cas de problème.

Lorsque vous remplacez un bloc d'alimentation à chaud, débranchez le cordon du bloc d'alimentation en cours de remplacement avant de le retirer du serveur.

Pour éviter tout risque d'électrocution, mettez le système hors tension et débranchez les cordons d'alimentation ainsi que les systèmes de télécommunication, réseaux et modems reliés au système avant d'ouvrir ce dernier.

Avertissements sur l'accès au système

Attention: Pour éviter de vous blesser ou d'endommager votre équipement, les consignes de sécurité suivantes s'appliquent chaque fois que vous accédez à l'intérieur du produit:

- Mettez hors tension tous les périphériques connectés à ce produit.
- Éteignez le système en appuyant sur le bouton d'alimentation.
- Déconnectez l'alimentation secteur en débranchant tous les cordons d'alimentation secteur du système ou de la prise murale.
- Déconnectez l'ensemble des câbles et lignes de télécommunication qui sont connectés au système.
- Mettez toutes les vis ou autres attaches de côté lorsque vous retirez les panneaux d'accès. Une fois que vous avez terminé d'accéder à l'intérieur du produit, refixez le panneau d'accès avec les vis ou attaches d'origine.
- N'essayez pas d'accéder à l'intérieur du bloc d'alimentation. Il ne contient aucune pièce réparable. Renvoyez-le au fabricant en cas de problème.
- Mettez le serveur hors tension et débranchez tous les cordons d'alimentation avant d'ajouter ou de remplacer tout composant non connectable à chaud.
- Lorsque vous remplacez le bloc d'alimentation à chaud, débranchez le cordon du bloc d'alimentation en cours de remplacement avant de retirer le bloc du serveur.

Attention: Si le serveur a été utilisé, les processeurs et dissipateurs de chaleur installés peuvent être chauds. À moins que vous n'ajoutiez ou ne retiriez un composant connectable à chaud, laissez le système refroidir avant d'ouvrir les panneaux. Pour éviter tout risque d'entrer en contact avec un composant chaud lors d'une installation à chaud, prenez toutes les précautions nécessaires lorsque vous retirez ou installez des composants connectables à chaud.

Attention: Pour éviter de vous blesser, ne touchez pas les pales de ventilateur en mouvement. Si votre système est fourni avec une protection sur le ventilateur, ne mettez pas le système en route sans la protection en place.

Décharges électrostatiques (ESD)

Attention: Les décharges électrostatiques (ESD) peuvent endommager les lecteurs de disque dur, les cartes et d'autres pièces. Il est fortement conseillé d'effectuer l'ensemble des procédures décrites à un poste de travail protégé contre les ESD. Au cas où aucun poste de ce type ne serait disponible, protégez-vous contre les ESD en portant un bracelet antistatique relié à la masse du châssis (n'importe quelle surface métallique non peinte) de votre serveur lorsque que vous manipulez les pièces.

Manipulez toujours les cartes avec précaution. Elles peuvent être extrêmement sensibles aux ESD. Ne tenez les cartes que par leurs bords. Après avoir retiré une carte de son emballage de protection ou du serveur, placez-la sur une surface reliée à la terre, exempte de charge statique, composants orientés vers le haut. Utilisez si possible un tapi de mousse conducteru, mais pas l'emballage de la carte. Veillez à ce que la carte ne glisse sur aucune surface.

Autres risques

Remplacement de la pile

Attention: Il existe un risque d'explosion si la pile n'est pas correctement remplacée. Lors du remplacement de la pile, utilisez uniquement celle recommandée par le fabricant du matériel.

Mettez la pile au rebut en vous conformant aux réglementations locales.

N'essayez pas de recharger une pile.

N'essayez pas de démonter, de percer ou d'endommager la pile d'une quelconque façon.

Refroidissement et ventilation

Attention: Routez les câbles avec précaution comme indiqué pour minimiser les blocages de circulation d'air et les problèmes de refroidissement.

Afin de permettre une ventilation et un refroidissement corrects, ne mettez le système en marche que lorsque les panneaux du châssis sont en place. L'utilisation du système sans les panneaux peut endommager les composants système. Pour installer les panneaux :

- Vérifiez tout d'abord que vous n'avez pas oublié d'outils ou de composants détachés à l'intérieur du système.
- Vérifiez que les câbles, les cartes d'extension et les autres composants sont correctement installés.
- Fixez les panneaux au châssis en suivant les instructions du produit.

Périphériques laser

Attention: Pour éviter tout risque d'exposition aux rayonnements et/ou de dommage personnel:

- N'ouvrez pas l'enceinte d'un périphérique laser.
- Les périphériques laser ne sont pas réparables par l'utilisateur.
- Retournez-les au fabricant en cas de problème.

Español

Información de seguridad del servidor

Este documento se aplica a las tarjetas de servidor de Intel[®], los gabinetes de servidor de Intel[®] (montaje en rack y en pedestal) y los dispositivos periféricos. Para reducir el riesgo de daños corporales, descargas eléctricas, fuego y en el equipo, lea este documento y preste atención a todas las advertencias y precauciones de esta guía antes de instalar o mantener el producto de servidor de Intel[®].







En el caso de que haya diferencias entre la información para un producto en particular contenida en este documento y la información proporcionada con dicho producto o en el sitio Web, la documentación del producto es la que prevalece.

Sólo personal técnico calificado debe montar y prestar los servicios para el servidor.

Debe ceñirse a las directrices de esta guía y a las instrucciones de montaje de los manuales del servidor para asegurar y mantener el cumplimiento con las certificaciones y homologaciones existentes de los productos. Utilice sólo los componentes descritos y homologados que se especifican en esta guía. El uso de otros productos o componentes anulará la homologación UL y otras certificaciones oficiales del producto, pudiendo dejar de ser compatible con las normativas locales de los países en los que se comercializa.

Advertencias y precauciones sobre seguridad

Para reducir la posibilidad de que se produzcan lesiones personales o daños en la propiedad, antes de empezar a instalar el producto, lea, observe y cumpla toda la información e instrucciones de seguridad siguientes. Puede que se utilicen los siguientes símbolos de seguridad en la documentación y es posible que aparezcan en el producto o en su embalaje.

| | |
|--|---|
| PRECAUCIÓN | Indica la existencia de un riesgo que podría causar lesiones personales o daños en la propiedad leves si no se tiene en cuenta la PRECAUCIÓN. |
| ADVERTENCIA | Indica la existencia de un riesgo que podría causar lesiones personales graves si no se tiene en cuenta la ADVERTENCIA. |
|  | Indica un riesgo potencial si no se tiene en cuenta la información indicada. |
|  | Indica riesgo de descargas eléctricas que podrían causar lesiones graves o la muerte si no se siguen las instrucciones de seguridad. |
|  | Indica componentes o superficies calientes. |
|  | Indica que no se deben tocar las aspas de los ventiladores, ya que de lo contrario se podrían producir lesiones. |
|  | Indica que es necesario desenchufar los cables de alimentación de CA para desconectar la alimentación de CA |
|  | Recicle por favor la batería |

Aplicaciones y usos previstos

Este producto ha sido evaluado como equipo de tecnología informática (ITE) que puede instalarse en oficinas, escuelas, salas de equipos informáticos o lugares de ámbito comercial similares. Es posible que sea necesario llevar a cabo una evaluación adicional para comprobar si este producto es apropiado para otras categorías de productos y entornos además de las aplicaciones informáticas (por ejemplo, soluciones médicas, industriales, residenciales, sistemas de alarma y equipos de pruebas).

Selección de la ubicación

El sistema se ha diseñado para funcionar en un entorno normal de oficinas. Seleccione una ubicación que esté:

- Limpia, seca y libre de macropartículas en suspensión en el aire (que no sean el polvo habitual de la habitación).
- Bien ventilada y alejada de fuentes de calor, incluida la luz solar directa y los radiadores.
- Alejada de fuentes de vibración o de golpes físicos.
- Aislada de campos electromagnéticos producidos por dispositivos eléctricos.
- En zonas propensas a tormentas eléctricas, se recomienda que conecte el servidor a un supresor de sobretensiones y desconecte las líneas de telecomunicaciones al módem durante una tormenta eléctrica.

- Provista de una toma de corriente alterna correctamente conectada a tierra.
- Provista de espacio suficiente para acceder a los cables de la fuente de alimentación ya que constituyen la desconexión principal de la alimentación.

Manipulación del equipo

Reduzca el riesgo de daños personales o en el equipo:

- Respete los requisitos de sanidad y seguridad laborales de su país cuando traslade y levante el equipo.
- Utilice medios mecánicos u otros que sean adecuados al trasladar o levantar el equipo.
- Para que el peso sea menor para manipularlo con más facilidad, extraiga los componentes que sean de fácil extracción.

Advertencias de alimentación y eléctricas

Precaución: *El botón de encendido, indicado con la marca del modo de reposo o stand-by, NO DESCONECTA completamente la alimentación de CA del sistema, ya que el modo de reposo de 5 V sigue activo mientras el sistema está enchufado. Para desconectar el sistema debe desenchufar el cable de alimentación de CA de la toma de la pared. Puede usar más de un cable de alimentación de CA con el sistema. Asegúrese de que todos los cables de alimentación de CA están desenchufados. Asegúrese de que los cables de alimentación de CA estén desenchufado antes de abrir le gabinete, agregar o extraer cualquier componente que no es de conexión en funcionamiento.*

Algunas fuentes de alimentación de electricidad de los servidores de Intel utilizan el polo neutral del fuselaje. Para evitar riesgos de choques eléctricos use precauciones al trabajar con las fuentes de alimentación que utilizan el polo neutral de fuselaje.

No intente modificar ni utilizar un cable de alimentación de CA si no es del tipo exacto requerido. Se necesita un cable de CA para cada fuente de alimentación del sistema.

La fuente de alimentación de este producto no contiene piezas que puedan ser reparadas por el usuario. No abra la fuente de alimentación. Dentro de la fuente de alimentación puede haber niveles de tensión, corriente y energía peligrosos. Devuélvala al fabricante para repararla.

Al reemplazar una fuente de alimentación de conexión en funcionamiento, desenchufe el cable de alimentación de la fuente de alimentación que va a reemplazar antes de extraerla del servidor.

Para evitar el riesgo de descargas eléctricas, antes de abrir el servidor, apáguelo, desconecte el cable de alimentación, los sistemas de telecomunicaciones, las redes y los módems conectados al mismo.

Advertencias el acceso al sistema

Precaución: *Para evitar lesiones personales o daños en la propiedad, se aplican las siguientes instrucciones de seguridad siempre que se acceda al interior del producto:*

- *Apague todos los dispositivos periféricos conectados a este producto.*

- *Pulse el botón de alimentación para apagar el sistema.*
- *Desconecte la alimentación de CA desenchufando los cables de alimentación de CA del sistema o de la toma de corriente alterna.*
- *Desconecte todos los cables y líneas de telecomunicación que estén conectados al sistema.*
- *Guarde todos los tornillos o elementos de fijación cuando retire las cubiertas de acceso. Cuando termine de operar en el interior del producto, vuelva a colocar los tornillos o los elementos de fijación originales de la cubierta de acceso.*
- *No acceda al interior de la fuente de alimentación. No hay elementos en la fuente de alimentación que usted pueda reparar y utilizar. Devuélvala al fabricante para repararla.*
- *Apague el servidor y desconecte todos los cables de alimentación antes de agregar o reemplazar cualquier componente que no es de conexión en funcionamiento.*
- *Al reemplazar una fuente de alimentación de conexión en funcionamiento, desenchufe el cable de alimentación de la fuente de alimentación que va a reemplazar antes de extraerla del servidor.*

Precaución: *Si el servidor se ha estado ejecutando, los procesadores y disipadores de calor estarán recalentados. A no ser que esté instalando o extrayendo un componente de conexión en funcionamiento, deje que el sistema se enfríe antes de abrir las cubiertas. Para que no llegue a tocar los componentes que estén calientes cuando esté realizando una instalación de conexión en funcionamiento, tenga cuidado al extraer o instalar los componentes de conexión en funcionamiento.*

Precaución: *Para evitar posibles daños, no toque las aspas en movimiento de los ventiladores. Si el sistema se le ha suministrado con una protección para el ventilador, asegúrese de que cuando esté funcionando el sistema la protección esté en su sitio.*

Descarga electrostática (ESD)

Precaución: *Las descargas electrostáticas pueden dañar las unidades de disco, las tarjetas y otros componentes. Recomendamos que realice todos los procedimientos en una estación de trabajo protegida contra descargas electrostáticas. En caso de que no haya una disponible, protéjase de alguna forma contra las descargas llevando un brazalete antiestático conectado a la toma de tierra de la carcasa (cualquier superficie de metal que no esté pintada) del servidor cuando manipule las piezas.*

Manipule siempre las tarjetas con el máximo cuidado. Pueden ser sumamente sensibles a las descargas electrostáticas. Sujételas sólo por los bordes. Una vez extraída la tarjeta de su envoltorio de protección o del servidor, colóquela con el lado de los componentes hacia arriba sobre una superficie con toma de tierra y sin carga estática. Utilice una

almohadilla de espuma conductora si dispone de ella, pero nunca el envoltorio de la tarjeta. No deslice la tarjeta sobre ninguna superficie.

Otros peligros

Sustitución de la batería

Precaución: *Existe el peligro de explosión si la batería no se reemplaza correctamente. Al reemplazar la batería, utilice sólo la batería recomendada por el fabricante del equipo.*

Deseche las baterías respetando la normativa local.

No intente recargar la batería.

No intente desmontar, pinchar o causar cualquier otro desperfecto a una batería.

Enfriamiento y circulación de aire

Precaución: *El tendido de los cables debe realizarse cuidadosamente tal y como se le indica para reducir al mínimo los problemas de obstrucción de la ventilación y de refrigeración.*

Para conseguir una refrigeración y corriente de aire adecuadas, compruebe que cuando sistema esté funcionando, las cubiertas de la carcasa están instaladas. Si utiliza el sistema sin las cubiertas, podría dañar sus componentes. Para instalar las cubiertas:

- *Compruebe primero que no ha dejado herramientas o piezas sueltas dentro del sistema.*
- *Compruebe que los cables, tarjetas adicionales y otros componentes están instalados correctamente.*
- *Sujete las cubiertas a la carcasa siguiendo las instrucciones del producto.*

Periféricos o dispositivos láser

Precaución: *Para evitar el riesgo de la exposición a radiaciones o de daños personales:*

- *No abra la caja de ningún periférico o dispositivo láser*
- *Los periféricos o dispositivos láser no pueden ser reparados por el usuario*
- *Haga que el fabricante los repare.*

简体中文

服务器安全信息

本文档适用于 Intel® 服务器主板、Intel® 服务器机箱（基座和机架固定件）和已安装的外设。为减少人身伤害、电击、火灾以及设备损坏的危险，请在安装或维护 Intel® 服务器产品之前阅读本文档并遵循本指南中的所有警告和预防措施。





如果本文档中的信息与特定产品的随附信息或 Web 站点信息之间存在不一致，请以产品文档为准。

服务器须由合格的技术人员进行集成和维护。

必须遵守本指南的规定和服务器手册的装配指导，以确保符合现有的产品认证和审批。仅使用本指南中描述和规定的指定组件。使用其他产品 / 组件将使产品的 UL 认证和其他管理审批无效，并可能导致产品不符合销售地的产品法规。

安全警告与注意事项

为避免人身伤害与财产损失，安装本产品之前，请阅读以下所有安全指导和信息。下面所列的安全符号可能在整个文档中使用并可能标注于产品和 / 或产品包装之上。

| | |
|---|-------------------------------------|
| 注意 | 表示如果无视此“注意事项”，存在可能引起轻微人身伤害或财产损失的危险。 |
| 警告 | 表示如果无视此“警告”，存在可能引起严重人身伤害的危险。 |
|  | 表示如果无视所示信息，即存在潜在的危险。 |
|  | 表示如果不遵守安全指导，存在可导致严重伤害或死亡的电击危险。 |
|  | 表示灼热组件或表面。 |
|  | 表示请勿触摸风机叶片，否则可能致伤。 |
|  | 表示拔下所有交流电线，断开交流电源 |

预期应用使用

根据评估，本产品为信息技术设备 (ITE)，可安装在办公室、学校、计算机房和类似的商业场所。本产品对于非 ITE 应用的其他产品种类和环境（如医疗、工业、住宅、报警系统和测试设备）的适用性尚有待进一步的评估。

场地选择

本系统专为在典型办公环境运行而设计。请选择符合以下条件的地点：

- 清洁、干燥，无气载微粒（而非一般的室内尘埃）。
- 通风良好，远离热源（包括直接日晒和散热器）。
- 远离振动源或物理震动。
- 与电气设备产生的强大电磁场隔离。
- 在易受闪电袭击的地区，我们建议将系统插入电涌抑制器并在闪电期间断开通信线路与调制解调器之间的连接。
- 提供正确接地的墙壁插座。
- 提供足够的空间，以便拿取电源供应线，因为这是本产品的主要电源断开器。

设备操作规范

减少人身伤害或设备受损的危险：

- 移举设备时遵守当地的职业健康与安全要求。
- 借助机械手段或其他合适的手段移举设备。
- 拆除一切易分离组件，以降低重量并方便操作。

电源与电气警告



⚠ 注意事项

电源按钮（如待机电源标记所示）并不能完全关闭系统的交流电源，只要系统已接通电源，就存在 5V

待机电源。要从系统切断电源，须从墙壁电源插座中拔下交流电线。您的系统可能不止使用一根交流电线。请确保所有的交流电线都已拔下。打开机箱或增加或去除任何热插拔组件之前，确保交流电线已拔下。

若非所需的确切类型，请勿尝试修改或使用交流电线。系统的每个电源供应设备都需要一根单独的交流电线。

本产品的电源供应设备包含非用户维修部件。请勿打开电源供应设备。电源供应设备包含非常危险的电压级、电流级和能量级。请与生产商联系维修事宜。

替换热插拔电源供应设备时，请先拔下需替换的电源供应设备上的电源线，再将其从服务器上移除。

为避免电击，请在打开服务器之前，关闭服务器并断开服务器上连接的电源线、电信系统、网络和调制解调器。

系统使用警告



⚠ 注意事项

为避免人身伤害或财产损失，无论何时检查产品内部，以下安全指导都适用：

- 关闭所有与本产品相连的外设。
- 按下电源按钮至关闭状态，关闭系统。
- 从系统或墙壁插座上拔下所有交流电线，断开交流电源。
- 断开与系统相连的所有线缆和通信线路。
- 卸除舱口盖时，保留所有螺钉及其他紧固件。完成产品内部检查之后，请用螺钉或紧固件重新固定舱口盖。
- 请勿打开电源供应设备。电源供应设备内设有可维修部件，请与生产商联系维修事宜。
- 增加或替换任何非热插拔组件之前，请关闭服务器电源并断开所有电源线。
- 替换热插拔电源供应设备时，请先拔下需替换的电源供应设备上的电源线，然后再从服务器上移除电源供应设备。



⚠ 注意事项

如果服务器一直在运行，任何已安装的处理器和吸热设备都可能很热。除非要增加或移除热插拔组件，否则请待系统冷却后再开盖。为避免在热插拔组件安装过程中接触灼热组件，移除或安装热插拔组件时必须小心。



⚠ 注意事项

为避免受伤，请勿触摸运转的风机叶片。如果系统的风机上配有防护装置，请勿卸下风机防护装置运行系统。

静电放电 (ESD)



注意事项

ESD 会损坏磁盘驱动器、主板及其他部件。我们建议您执行 ESD 工作站的所有步骤。如果没有 ESD 工作站，则采取一些静电放电保护措施。操作部件时，戴上与服务器上的机箱接地或任何无喷漆金属表面连接的防静电腕带。

操作主板时始终保持小心。它们可能对 ESD 非常敏感。拿持主板时只接触边缘。从保护包装中或从服务器上取出主板后，请将主板组件侧面朝上放置于无静电的接地表面上。请使用导电泡沫垫（若有），不要使用主板包装。请勿将主板在任何表面上滑动。

其他危险

替换电池



注意事项

不正确替换电池可能导致爆炸危险。替换电池时，请只使用设备生产商推荐使用的电池。

请按当地法规处置电池。

请勿对电池充电。

请勿拆卸、刺穿或以其他方式损坏电池。

冷却和气流



注意事项

按照说明小心布置线缆，尽量减少气流阻塞和冷却问题。

为保证适当的冷却和气流，运行系统时请确保机箱盖已安装。未安装机箱盖即运行系统可能导致系统部件受损。安装机箱盖的步骤如下：

- 首先检查并确保系统内没有遗留的未固定工具或部件。
- 检查线缆、内插板和其他组件已正确安装。
- 按产品说明安装机箱盖。

激光外设或激光设备



注意事项

为避免幅射暴露和 / 或人身伤害:

- 请勿打开任何激光外设或激光设备的外壳
- 激光外设或激光设备为非用户维修设备

请与生产商联系维修事宜