



Intel[®] Server Board S1200BT

Technical Product Specification

Intel order number G13326-003



Revision 1.0

March, 2011

Enterprise Platforms and Services Division

Revision History

Date	Revision Number	Modifications
July 2010	0.3	Initial release.
November 2010	0.5	Updated the hardware info and SE SKU.
January 2011	0.7	Updated S1200BTS info and BIOS setup page.
January 2011	0.9	Updated S1200BT video mode.
March 2011	1.0	Corrected typos.

Disclaimers

Information in this document is provided in connection with Intel® products. No license, express or implied, by estoppel or otherwise, to any intellectual property rights is granted by this document. Except as provided in Intel's Terms and Conditions of Sale for such products, Intel® assumes no liability whatsoever, and Intel® disclaims any express or implied warranty, relating to sale and/or use of Intel® products including liability or warranties relating to fitness for a particular purpose, merchantability, or infringement of any patent, copyright or other intellectual property right. Intel® products are not intended for use in medical, life saving, or life sustaining applications. Intel® may make changes to specifications and product descriptions at any time, without notice.

Designers must not rely on the absence or characteristics of any features or instructions marked "reserved" or "undefined". Intel® reserves these for future definition and shall have no responsibility whatsoever for conflicts or incompatibilities arising from future changes to them.

Information provided in this document may be incomplete (as denoted by TBD). Revised information will be published in a later release of this document and when the related product is made available.

The Intel® Server Board S1200BT may contain design defects or errors known as errata which may cause the product to deviate from published specifications. Current characterized errata are available on request.

Intel Corporation server boards contain a number of high-density VLSI and power delivery components that need adequate airflow to cool. Intel's own chassis are designed and tested to meet the intended thermal requirements of these components when the fully integrated system is used together. It is the responsibility of the system integrator that chooses not to use Intel® developed server building blocks to consult vendor datasheets and operating parameters to determine the amount of airflow required for their specific application and environmental conditions. Intel Corporation cannot be held responsible if components fail or the server board does not operate correctly when used outside any of their published operating or non-operating limits.

Intel, Pentium, Itanium, and Xeon are trademarks or registered trademarks of Intel Corporation.

*Other brands and names may be claimed as the property of others.

Copyright © Intel Corporation 2011.

Table of Contents

1. Introduction	1
1.1 Chapter Outline	1
1.2 Server Board Use Disclaimer	1
2. Overview	2
2.1 Intel® Server Board S1200BT Feature Set	2
2.2 Server Board Layout	4
2.2.1 Server Board Connector and Component Layout	5
2.2.2 Intel® Server Board S1200BTL Mechanical Drawings	8
2.2.3 Server Board Rear I/O Layout	14
3. Functional Architecture	15
3.1 Processor Sub-System	16
3.1.1 Intel® Xeon® Processor E3-1200 Series	16
3.1.2 Intel® Core™ Processor i3-2100 Series	17
3.1.3 Intel® Turbo Boost Technology	17
3.2 Memory Subsystem	17
3.2.1 Memory Supported	18
3.2.2 Post Error Codes	18
3.2.3 Memory Map and Population Rules	19
3.2.4 Publishing System Memory	21
3.2.5 Memory RAS Support	21
3.3 Intel® Chipset PCH	21
3.4 I/O Sub-system	22
3.4.1 Digital Media Interface (DMI)	22
3.4.2 PCI Express Interface	22
3.4.3 Serial ATA Support	22
3.4.4 Low Pin Count (LPC) Interface	23
3.4.5 USB 2.0 Support	23
3.5 Optional Intel® SAS RAID Module	24
3.6 Integrated Baseboard Management Controller	24
3.6.1 Integrated BMC Embedded LAN Channel	26
3.6.2 Optional RMM4 Advanced Management Board	27
3.6.3 Serial Ports	27

3.6.4	Floppy Disk Controller	27
3.6.5	Keyboard and Mouse Support	28
3.6.6	Wake-up Control.....	28
3.7	Video Support	28
3.7.1	Intel® Server Board S1200BTL	28
3.7.2	Video for Intel® Server Board S1200BTS	29
3.8	Network Interface Controller (NIC)	29
3.8.1	Gigabit Ethernet Controller 82574L	29
3.8.2	Gigabit Ethernet PHY 82579	29
3.8.3	MAC Address Definition.....	30
3.9	Intel® I/O Acceleration Technology 2 (Intel® I/OAT2)	30
3.9.1	Direct Cache Access (DCA)	30
3.10	Intel® Virtualization Technology for Directed I/O (Intel® VT-d)	30
3.11	TPM (Trusted Platform Module)	30
4.	Platform Management.....	32
4.1	Feature Support.....	33
4.1.1	IPMI 2.0 Features	33
4.1.2	Non-IPMI Features	33
4.1.3	New Manageability Features	34
4.2	Basic and Optional Advanced Management Features	35
4.2.1	Enabling Advanced Management Features.....	35
4.2.2	Keyboard, Video, and Mouse (KVM) Redirection	36
4.2.3	Media Redirection.....	37
4.2.4	Embedded Web server	39
4.2.5	Embedded Platform Debug	40
4.2.6	Data Center Management Interface (DCMI)	41
4.2.7	Local Directory Authentication Protocol (LDAP)	41
4.3	Thermal Control	41
4.3.1	Memory Thermal Throttling.....	41
4.3.2	Fan Speed Control.....	42
4.4	Intel® Intelligent Power Node Manager	42
4.4.1	Overview	42
4.4.2	Features.....	43
4.4.3	Role of Integrated BMC in NM.....	44
5.	Server Management Capability for Intel® Server Board S1200BTS	46

5.1	Supper I/O	46
5.1.1	Key Features of supper I/O.....	46
6.	BIOS User Interface.....	47
6.1	BIOS POST Initialization.....	47
6.1.1	BIOS Revision Identification	47
6.2	HotKeys Supported During POST	48
6.3	POST Logo Screen/Diagnostic Screen	49
6.4	BIOS Boot Pop-up Menu	50
6.5	BIOS Setup Utility	50
6.5.1	BIOS Setup Operation	50
6.5.2	BIOS Setup Utility Screens.....	53
7.	Connector/Header Locations and Pin-outs.....	90
7.1	Board Connector Information.....	90
7.2	Power Connectors	91
7.3	System Management Headers	92
7.3.1	Intel® Remote Management Module 4 (Intel® RMM4) Lite connetor and Dedicated NIC connector	92
7.3.2	LPC/IPMB Header	93
7.3.3	HSBP Header	93
7.3.4	SGPIO Header.....	93
7.4	Front Control Panel Connector	93
7.4.1	Power Button	94
7.4.2	Reset Button	95
7.4.3	System Status Indicator LED	95
7.5	I/O Connectors.....	96
7.5.1	VGA Connector.....	96
7.5.2	Rear NIC and USB connector.....	96
7.5.3	SATA	97
7.5.4	SAS Connectors	97
7.5.5	Serial Port Connectors.....	98
7.5.6	USB Connector.....	99
7.6	PCI Express* Slot/PCI Slot/Riser Card Slot.....	100
7.7	Fan Headers	103
8.	Jumper Blocks.....	104
8.1	CMOS Clear and Password Reset Usage Procedure	105

8.1.1	Clearing the CMOS.....	106
8.1.2	Clearing the Password.....	106
8.2	Integrated BMC Force Update Procedure (Only for The Intel® Server Board S1200BTL).....	107
8.3	ME Force Update Jumper.....	107
8.4	BIOS Recovery Jumper	108
9.	Intel® Light Guided Diagnostics.....	109
9.1	System Status LED (Only for S1200BTL).....	109
9.2	Post Code Diagnostic LEDs	109
10.	Design and Environmental Specifications.....	111
10.1	Intel® Server Board S1200BT Design Specifications.....	111
10.2	Board-level Calculated MTBF	111
10.2.1	Processor Power Support.....	111
10.3	Power Supply Output Requirements	112
10.3.1	Grounding.....	113
10.3.2	Standby Outputs	113
10.3.3	Remote Sense	113
10.3.4	Voltage Regulation	113
10.3.5	Dynamic Loading	113
10.3.6	Capacitive Loading	114
10.3.7	Closed-loop Stability	114
10.3.8	Common Mode Noise	114
10.3.9	Ripple / Noise	114
10.3.10	Timing Requirements.....	114
10.3.11	Residual Voltage Immunity in Standby Mode	117
10.3.12	Protection Circuits.....	117
	Appendix A: Integration and Usage Tips.....	119
	Appendix B: Integrated BMC Sensor Tables.....	120
	Appendix C: POST Code Diagnostic LED Decoder	129
	Appendix D: POST Code Errors	133
	Appendix E: Supported Intel® Server Chassis	136
	Glossary.....	137
	Reference Documents	141

List of Figures

Figure 1. Intel® Server Board S1200BTL Picture	4
Figure 2. Intel® Server Board S1200BTS Picture.....	5
Figure 3. Intel® Server Board S1200BTL Layout	6
Figure 4. Intel® Server Board S1200BTS Layout.....	7
Figure 5. Intel® Server Board S1200BTL – Hole and Component Positions.....	9
Figure 6. Intel® Server Board S1200BTL – Major Connector Pin Location (1 of 2)	10
Figure 7. Intel® Server Board S1200BTL – Major Connector Pin Location (2 of 2)	11
Figure 8. Intel® Server Board S1200BTL – Primary Side Keepout Zone	12
Figure 9. Intel® Server Board S1200BTL – Secondary Side Keepout Zone	13
Figure 10. Intel® Server Board S1200BT Rear I/O Layout.....	14
Figure 11. Intel® Server Board S1200BTL Functional Block Diagram	15
Figure 12. Intel® Server Board S1200BTS Functional Block Diagram.....	16
Figure 13. Integrated BMC Hardware	26
Figure 14. Server Management Bus (SMBUS) Block Diagram.....	32
Figure 15. Main Screen.....	56
Figure 16. Advanced Screen	59
Figure 17. Processor Configuration Screen.....	62
Figure 18. Memory Configuration Screen	68
Figure 19. Mass Storage Controller Configuration Screen	71
Figure 20. Serial Port Configuration Screen	72
Figure 21. USB Configuration Screen.....	73
Figure 22. PCI Configuration Screen	74
Figure 23. System Acoustic and Performance Configuration	75
Figure 24. Security Screen	75
Figure 25. Server Management Screen (S1200BTL)	76
Figure 26. Server Management Screen (S1200BTS)	77
Figure 27. Console Redirection Screen	77
Figure 28. System Information Screen (S1200BTL)	78
Figure 29. System Information Screen (S1200BTS).....	79
Figure 30. BMC LAN Configuration Screen (S1200BTL).....	80
Figure 31. Hardware Monitor Screen, Auto Fan Control (S1200BTS)	81
Figure 32. Hardware Monitor Screen, Manual Fan Control (S1200BTS).....	81

Figure 33. Realtime Teperature and Voltage Status Screen (S1200BTS)	82
Figure 34. Boot Options Screen.....	83
Figure 35. Hard Disk Order Screen	84
Figure 36. CDROM Order Screen.....	84
Figure 37. Floppy Order Screen	85
Figure 38. Network Device Order Screen	85
Figure 39. BEV Device Order Screen	86
Figure 40. Add EFI Boot Option Screen	86
Figure 41. Delete EFI Boot Option Screen	87
Figure 42. Boot Manager Screen.....	87
Figure 43. Error Manager Screen	88
Figure 44. System Event Log Screen (S1200BTS)	88
Figure 45. Exit Screen	89
Figure 46. Jumper Blocks (J4A2, J1F1, J1F3, J1F2, and J1E2) on S1200BTL	104
Figure 47. Jumper Blocks (J2G1, J1G1, J1H3, and J2J1) on S1200BTS	105
Figure 48. POST Code Diagnostic LED Location	110
Figure 49. Output Voltage Timing	115
Figure 50. Turn On/Off Timing (Power Supply Signals).....	116

List of Tables

Table 1. Intel® Server Board S1200BT Feature Set.....	2
Table 2. Major Board Components	6
Table 3. Major Board Components	7
Table 4. Memory Configuration Table.....	20
Table 5. UDIMM memory configuration rule	20
Table 6. UDIMM Maximum configuration.....	20
Table 7. Optional RMM4 Advanced Management Board Features	27
Table 8. Serial B Header (J1B2 on S1200BTL or J8A1 on S1200BTS) Pin-out.....	27
Table 9. Video Modes	28
Table 10. Dual Video Modes.....	29
Table 11. Basic and Advanced Management Features	35
Table 12. NM Features	43
Table 13. POST HotKeys Recognized.....	49
Table 14. BIOS Setup Page Layout.....	51
Table 15. BIOS Setup: Keyboard Command Bar.....	52
Table 16. Screen Map.....	54
Table 17. Board Connector Matrix on S1200BTL	90
Table 18. Board Connector Matrix on S1200BTS.....	91
Table 19. Baseboard Power Connector Pin-out (J9G1)	91
Table 20. SSI Processor 8-PIN Power Connector Pin-out (J9A1)	92
Table 21. Intel® RMM4 lite Connector Pin-out (J4B1).....	92
Table 22. Dedicated NIC connector for RMM4	92
Table 23. LPC/IPMB Header Pin-out (J1H5)	93
Table 24. HSBP Header Pin-out (J1J2)	93
Table 25. SGPIO Header Pin-out (J1J3 on S1200BTL and J2J2 on S1200BTS)	93
Table 26. Front Panel SSI Standard 24-pin Connector Pin-out (J1C1 on S1200BTL or J1C2 on S1200BTS).....	93
Table 27. System Status LED Indicator States	95
Table 28. VGA Connector Pin-out	96
Table 29. RJ-45 10/100/1000 NIC Connector Pin-out	96
Table 30. RJ-45 10/100/1000 NIC Connector Pin-out (J6A1).....	97
Table 31. 6Gb/s SATA Connector Pin-Out	97
Table 32. 3Gb/s SATA Connector Pin-out	97

Table 33. SAS Connector Pin-out (J2H1)	98
Table 34. External Serial A Port Pin-out (J8A1).....	98
Table 35. Internal 9-pin Serial B Header Pin-out (J1B2).....	98
Table 36. Internal USB Connector Pin-out (J1E1, J1D1).....	99
Table 37. Pin-out of Internal USB Connector for low-profile Smart module (J3F2)	99
Table 38. Pin-out of adaptive riser slot/PCI Express slot 6.....	100
Table 39. Three PCI Express* x8 connectors (J2B2, J3B1 and J4B2)	102
Table 40. One PCI X32 connector (J1B1)	102
Table 41. SSI 4-pin Fan Header Pin-out.....	103
Table 42. Server Board Jumpers (J1F1, J1F2, J1F3, J1E2, and J4A2) on S1200BTL	104
Table 43. Server Board Jumpers (J2G1, J1G1, J1H3, and J2J1) on S1200BTS	105
Table 44. Front Panel LED Behavior Summary	109
Table 45. Server Board Design Specifications	111
Table 46. Intel® Xeon® Processor TDP Guidelines	112
Table 47. 350-W Load Ratings	112
Table 48. Voltage Regulation Limits	113
Table 49. Transient Load Requirements.....	113
Table 50. Capacitive Loading Conditions	114
Table 51. Ripple and Noise.....	114
Table 52. Output Voltage Timing	115
Table 53. Turn On/Off Timing	116
Table 54. Over-Current Protection (OCP).....	117
Table 55. Over-voltage Protection (OVP) Limits	117
Table 56. BMC Core Sensors	122
Table 57. POST Progress Code LED Example	129
Table 58. POST Progress Codes	129
Table 59. POST Error Codes and Messages	133
Table 60. POST Error Beep Codes	135

<This page is intentionally left blank.>

1. Introduction

This Technical Product Specification (TPS) provides board specific information detailing the features, functionality, and high-level architecture of the Intel® Server Board S1200BT.

In addition, you can obtain design-level information for specific subsystems by ordering the External Product Specifications (EPS) or External Design Specifications (EDS) for a given subsystem. EPS and EDS documents are not publicly available and must be ordered through your local Intel® representative.

1.1 Chapter Outline

This document is divided into the following chapters:

- Chapter 1 – Introduction
- Chapter 2 – Server Board Overview
- Chapter 3 – Functional Architecture
- Chapter 4 – Platform Management
- Chapter 5 – Server Management Capability
- Chapter 6 – BIOS User Interface
- Chapter 7 – Connector/Header Locations and Pin-outs
- Chapter 8 – Jumpers Blocks
- Chapter 9 – Intel® Light-Guided Diagnostics
- Chapter 10 – Design and Environmental Specifications
- Appendix A – Integration and Usage Tips
- Appendix B – Integrated BMC Sensor Tables
- Appendix C – POST Code Diagnostic LED Decoder
- Appendix D – POST Code Errors
- Appendix E – Supported Intel® Server Chassis
- Glossary
- Reference Documents

1.2 Server Board Use Disclaimer

Intel Corporation server boards contain a number of high-density VLSI and power delivery components that need adequate airflow to cool. Intel® ensures through its own chassis development and testing that when Intel® server building blocks are used together, the fully integrated system meets the intended thermal requirements of these components. It is the responsibility of the system integrator who chooses not to use Intel® developed server building blocks to consult vendor datasheets and operating parameters to determine the amount of airflow required for their specific application and environmental conditions. Intel Corporation cannot be held responsible if components fail or the server board does not operate correctly when used outside any of their published operating or non-operating limits.

2. Overview

The Intel® Server Board S1200BT is a monolithic printed circuit board (PCB) with features designed to support entry-level servers. It has two board SKUs, namely S1200BTL and S1200BTS.

2.1 Intel® Server Board S1200BT Feature Set

Table 1. Intel® Server Board S1200BT Feature Set

Feature	Description of S1200BTL	Description of S1200BTS
Processor	Support for one Intel® Xeon® Processor E3-1200 Series or Intel® Core™ Processor i3-2100 Series in FC-LGA 1155 socket package. <ul style="list-style-type: none"> ▪ 2.5 GT/s point-to-point DMI interface to PCH ▪ LGA 1155 pin socket 	Support for one Intel® Xeon® Processor E3-1200 Series or Intel® Core™ Processor i3-2100 Series in FC-LGA 1155 socket package. <ul style="list-style-type: none"> ▪ 2.5 GT/s point-to-point DMI interface to PCH ▪ LGA 1155 pin socket
Memory	Two memory channels with support for 1066/1333 MHz ECC Unbuffered (UDIMM) DDR3. <ul style="list-style-type: none"> ▪ Up to 2 UDIMMs per channel ▪ 32 GB max with x8 ECC UDIMM (2 Gb DRAM) 	Two memory channels with support for 1066/1333 MHz ECC Unbuffered (UDIMM) DDR3. <ul style="list-style-type: none"> ▪ Up to 2 UDIMMs per channel 32 GB max with x8 ECC UDIMM (2 Gb DRAM)
Chipset	Support for Intel® C204 Platform Controller Hub (PCH) chipset ServerEngines* LLC Pilot III BMC controller (Integrated BMC)	Support for Intel® C202 Platform Controller Hub (PCH) chipset
I/O	External connections: <ul style="list-style-type: none"> ▪ DB-15 video connectors ▪ DB-9 serial Port A connector ▪ Four ports on two USB/LAN combo connectors at rear of board Internal connections: <ul style="list-style-type: none"> ▪ Two USB 2x5 pin headers, each supporting two USB 2.0 ports ▪ One 2x5 Serial Port B headers ▪ Two 6Gb/s SATA ports and four 3Gb/s SATA ports ▪ One SAS mezzanine slot for optional SAS module 	External connections: <ul style="list-style-type: none"> ▪ DB-15 video connectors ▪ DB-9 serial Port A connector ▪ Four ports on two USB/LAN combo connectors at rear of board Internal connections: <ul style="list-style-type: none"> ▪ Two USB 2x5 pin headers, each supporting two USB 2.0 ports ▪ One 2x5 Serial Port B headers ▪ Six 3Gb/s SATA ports

Feature	Description of S1200BTL	Description of S1200BTS
Add-in PCI Card, PCI Express* Card	<ul style="list-style-type: none"> ▪ Slot1: One 5V PCI 32 bit/33 MHz connector ▪ Slot3: One PCI Express* Gen2 x8 (x4 throughput) connector ▪ Slot4: One PCI Express* Gen2 x8 (x4 throughput) connector ▪ Slot5: One PCI Express* Gen2 x8 (x4 throughput) connector ▪ Slot6: One PCI Express* Gen2 x16 (x8 throughput) connector 	<ul style="list-style-type: none"> ▪ Slot4: One 5V PCI 32 bit/33 MHz connector ▪ Slot5: One PCI Express* Gen2 x8 (x4 throughput) connector ▪ Slot6: One PCI Express* Gen2 x8 (x8 throughput) connector ▪ Slot7: One PCI Express* Gen2 x16 (x8 throughput) connector
System Fan Support	Five 4-pin fan headers supporting four system fans and one processor	Four 4-pin fan headers supporting four system fans and one processor
Video	Onboard ServerEngines* LLC Pilot III BMC Controller <ul style="list-style-type: none"> ▪ External 32MB (or above) DDR3 800MHz memory 	Silicon Motion SM712GX04LF02-BA
Onboard Hard Drive	Support for six Serial ATA II hard drives through six onboard SATA II connectors with SW RAID 0, 1, 5, and 10 Up to four SAS hard drives through optional Intel® SAS Entry RAID Module card Two 6Gb/s SATA ports and four 3Gb/s SATA ports	Support for six Serial ATA II hard drives through six onboard SATA II connectors with SW RAID 0, 1, 5 and 10. Six 3Gb/s SATA ports
RAID Support	<ul style="list-style-type: none"> ▪ Intel® Embedded Server RAID Technology II through onboard SATA connectors provides SATA RAID 0, 1, and 10 and optional RAID 5 support provided by the Intel® RAID Activation Key AXXRAKSW5 ▪ Intel® Rapid Storage RAID through onboard SATA connectors provides SATA RAID 0, 1, 5, and 10 ▪ One optional internal SAS module connector which supports AXXRMS2AF040, AXXRMS2LL040, and AXX4SASM0D 	<ul style="list-style-type: none"> ▪ Intel® Embedded Server RAID Technology II through onboard SATA connectors provides SATA RAID 0, 1, and 10 and optional RAID 5 support provided by the Intel® RAID Activation Key AXXRAKSW5. ▪ Intel® Rapid Storage RAID through onboard SATA connectors provides SATA RAID 0, 1, 5, and 10.
LAN	One Gigabit Ethernet device 82574L connect to PCI-E x1 interfaces on the PCH One Gigabit Ethernet PHY 82579 connected to PCH through PCI-E x1 interface	One Gigabit Ethernet device 82574L connect to PCI-E x1 interfaces on the PCH One Gigabit Ethernet PHY 82579 connected to PCH through PCI-E x1 interface
Server Management	Onboard LLC Pilot III Controller (iBMC) <ul style="list-style-type: none"> ▪ Integrated Baseboard Management Controller (Integrated BMC), IPMI 2.0 compliant ▪ Integrated 2D video controller on PCI-E x1 Optional Intel® Remote Management Module 4 (RMM4) Lite only or Intel® Remote Management Module 4 (RMM4)	—
Security	TPM module connector	TPM module connector

2.2 Server Board Layout

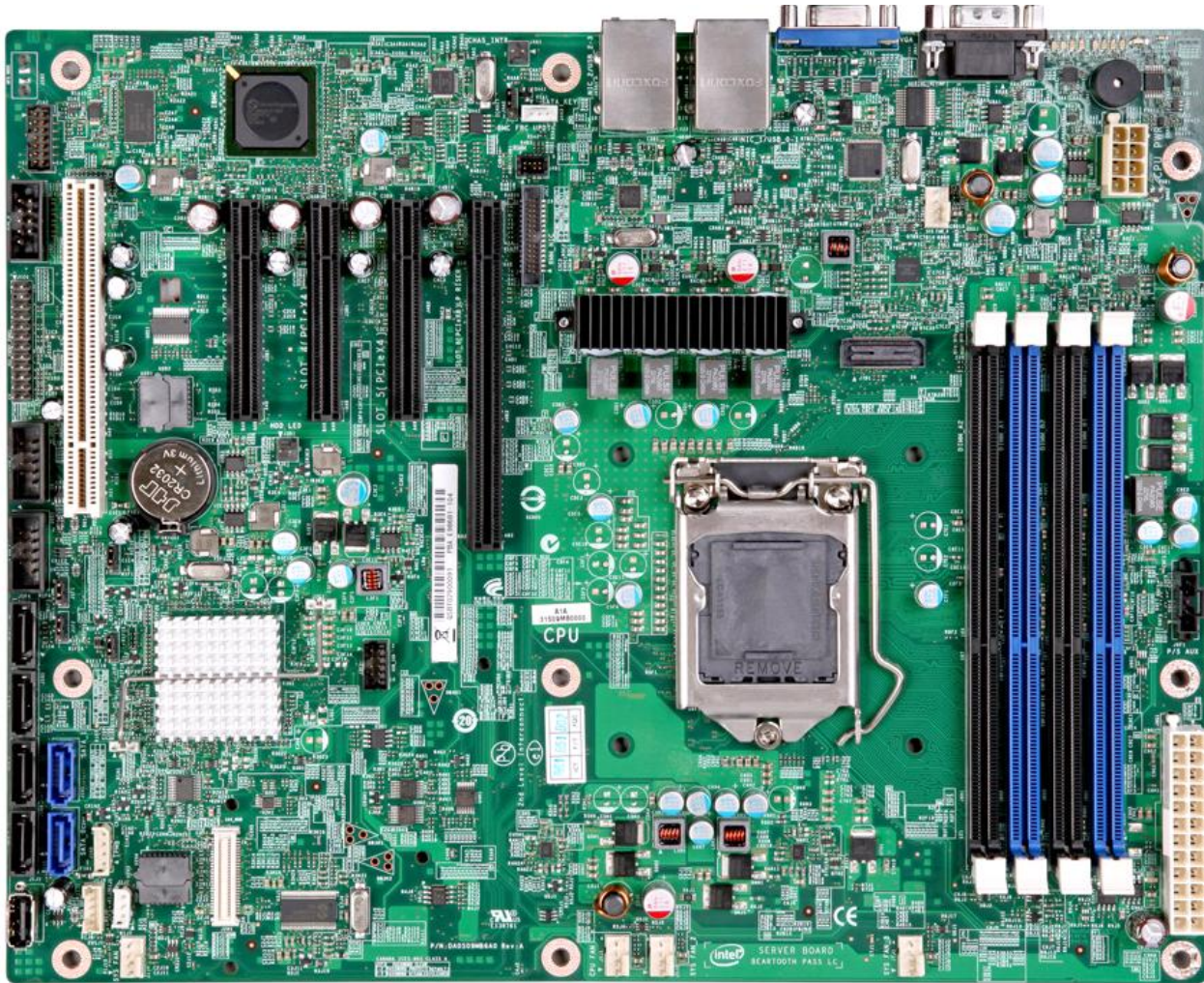

Figure 1. Intel® Server Board S1200BTL Picture

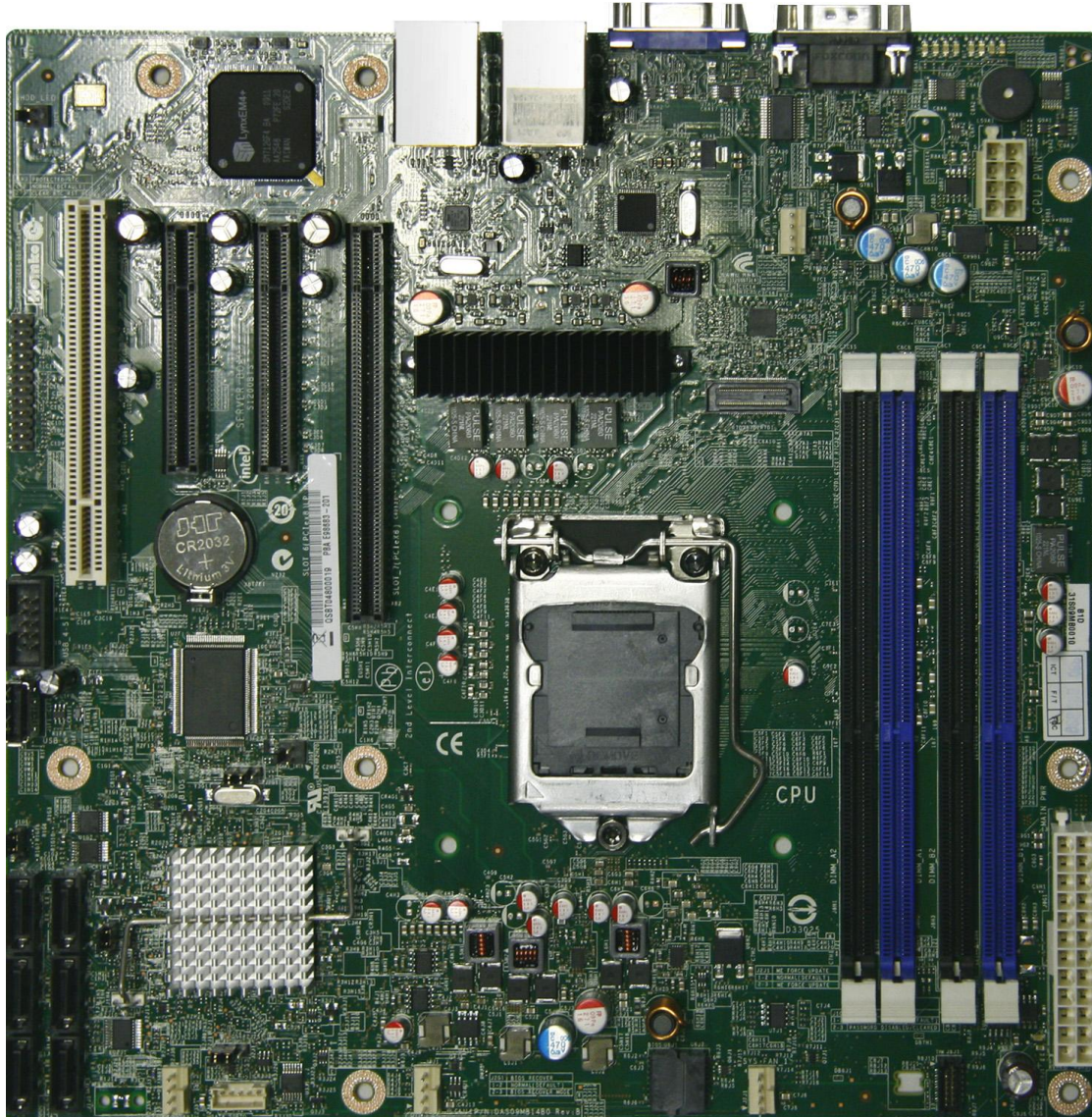
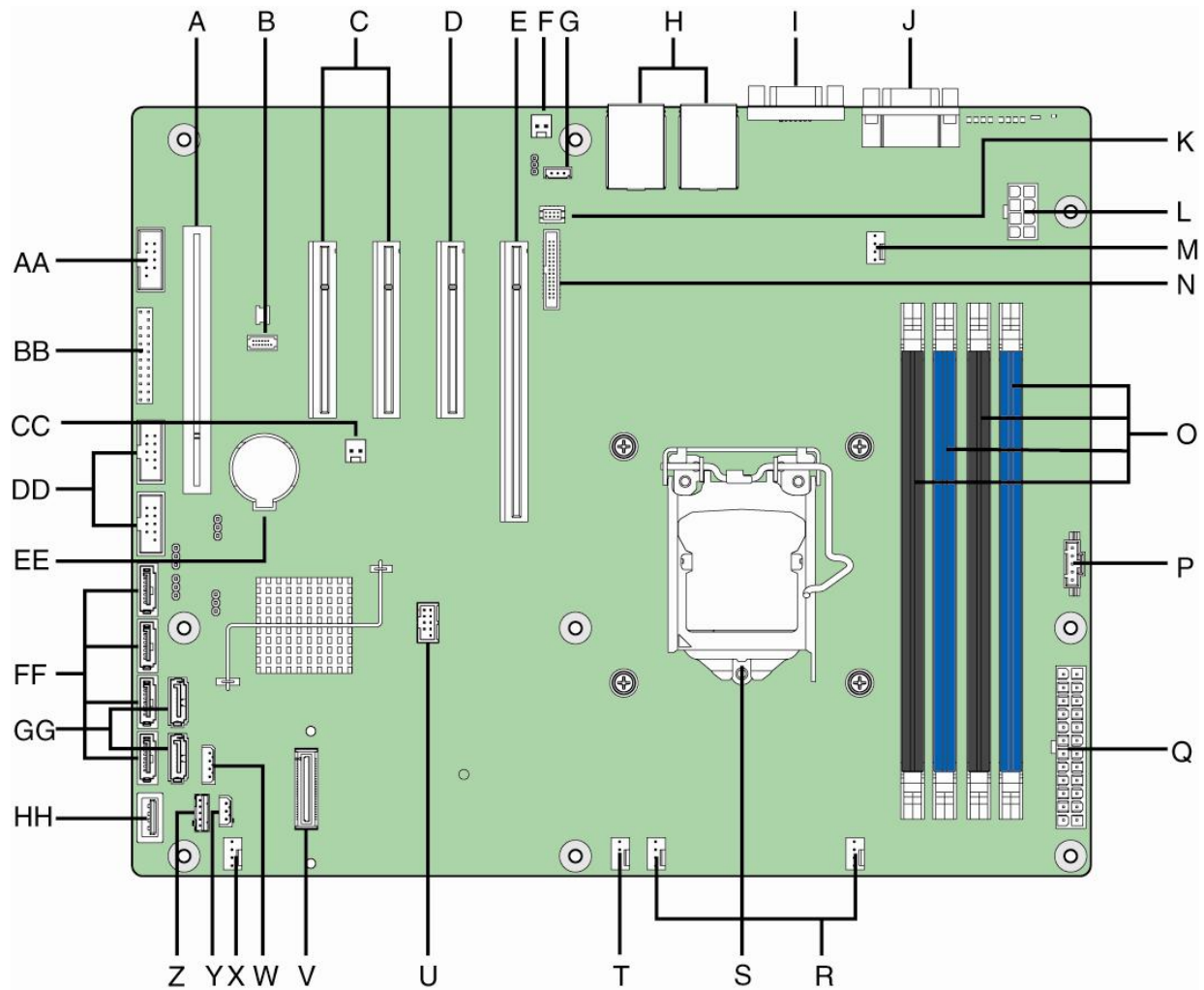

Figure 2. Intel® Server Board S1200BTS Picture

2.2.1 Server Board Connector and Component Layout

The following figure shows the board layout of the server board. Each connector and major component is identified by a number or letter, and Table 2 provides the description.



AF003509

Figure 3. Intel® Server Board S1200BTL Layout

Table 2. Major Board Components

	Description		Description
A	Slot 1, 32 Mbit/33 MHz PCI	R	System FAN2 and System FAN3 Connector
B	TPM	S	CPU connector
C	Slot 3/4, PCI Express* Gen2 x4 (x8 connector)	T	CPU Fan connector
D	Slot 5, PCI Express* Gen2 x4 (x8 connector)	U	USB connector for smart module
E	Slot 6, PCI Express* Gen2 x8 (x16 connector)	V	SAS Module connector
F	Chassis Intrusion	W	IPMB
G	SATA_KEY	X	SYS_FAN_1
H	Two Ethernet and Dual USB COMBO	Y	HSBP
I	Video port	Z	SATA_SGPIO
J	External Serial port	AA	Internal Serial Connector
K	RMM4 Lite Connector	BB	Front Panel Connector

Description		Description	
L	CPU Power Connector	CC	HDD LED
M	SYS_FAN_4	DD	Internal USB Connector
N	RMM4 Dedicated NIC connector	EE	CMOS battery
O	Four DIMM Slots	FF	Four 3Gb/s SATA ports
P	P/S AUX	GG	Two 6Gb/s SATA ports
Q	MAIN POWER	HH	Smart module

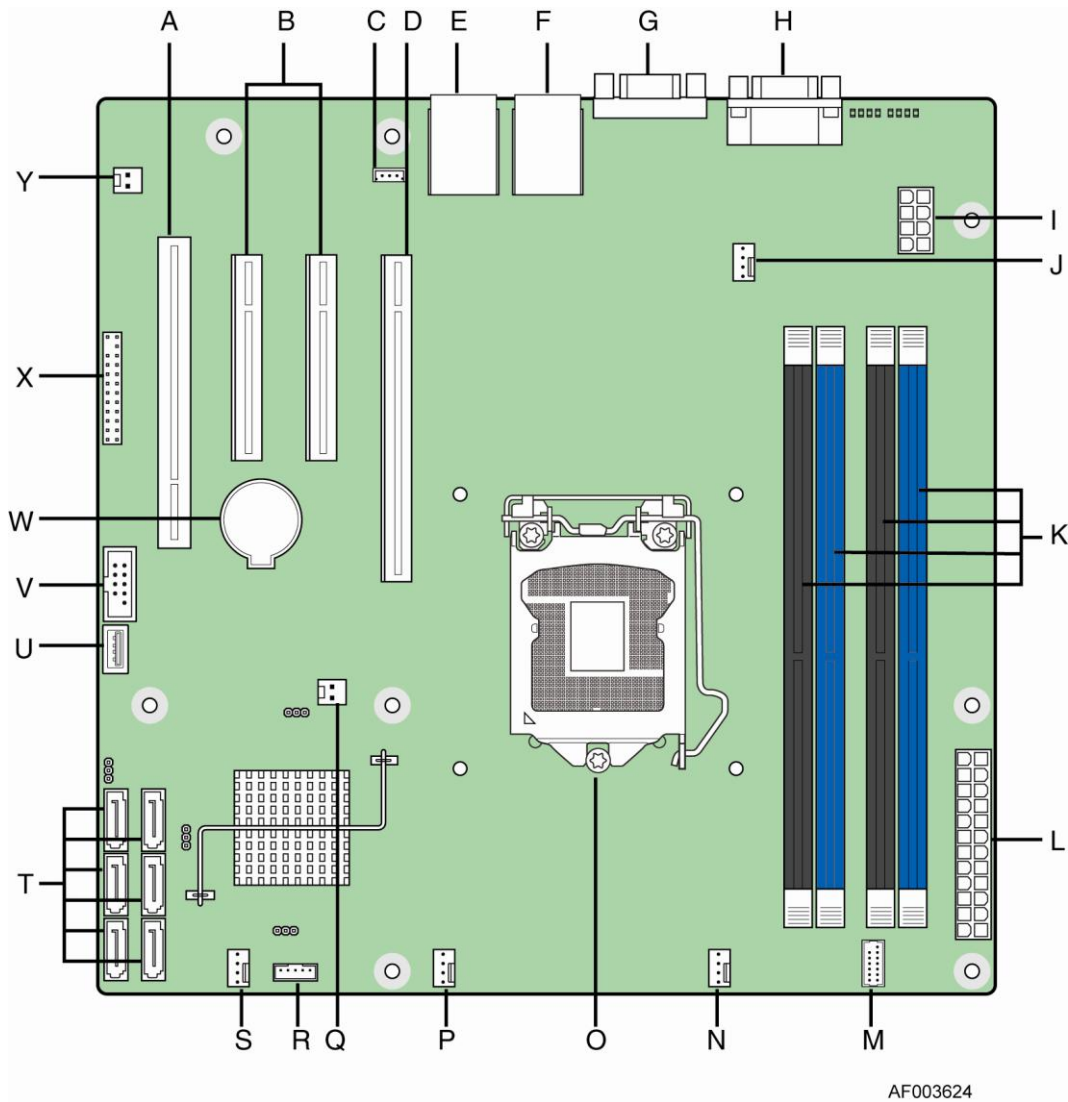

AF003624

Figure 4. Intel® Server Board S1200BTS Layout

Table 3. Major Board Components

Description		Description	
A	Slot 4, 32 Mbit/33 MHz PCI	N	SYS FAN 1
B	Slot 5, PCI Express* Gen2 x8 (x8 connector); Slot 6, PCI Express* Gen2x4 (x8 connector).	O	CPU connector

	Description		Description
C	SATA_KEY	P	CPU Fan connector
D	Slot 7, PCI Express* Gen2 x8 (x16 connector)	Q	Chassis Intrusion
E	Ethernet and Dual USB COMBO	R	SATA_SGPIO
F	Ethernet and Dual USB COMBO	S	SYS_FAN_3
G	Video port	T	Six 3Gb/s SATA ports
H	External Serial port	U	Low profile USB connector
I	CPU Power connector	V	Internal USB
J	SYS_FAN_2	W	CMOS battery
K	DIMM slots	X	Front Panel
L	MAIN power connector	Y	HDD LED
M	TPM connector		

2.2.2 Intel® Server Board S1200BTL Mechanical Drawings

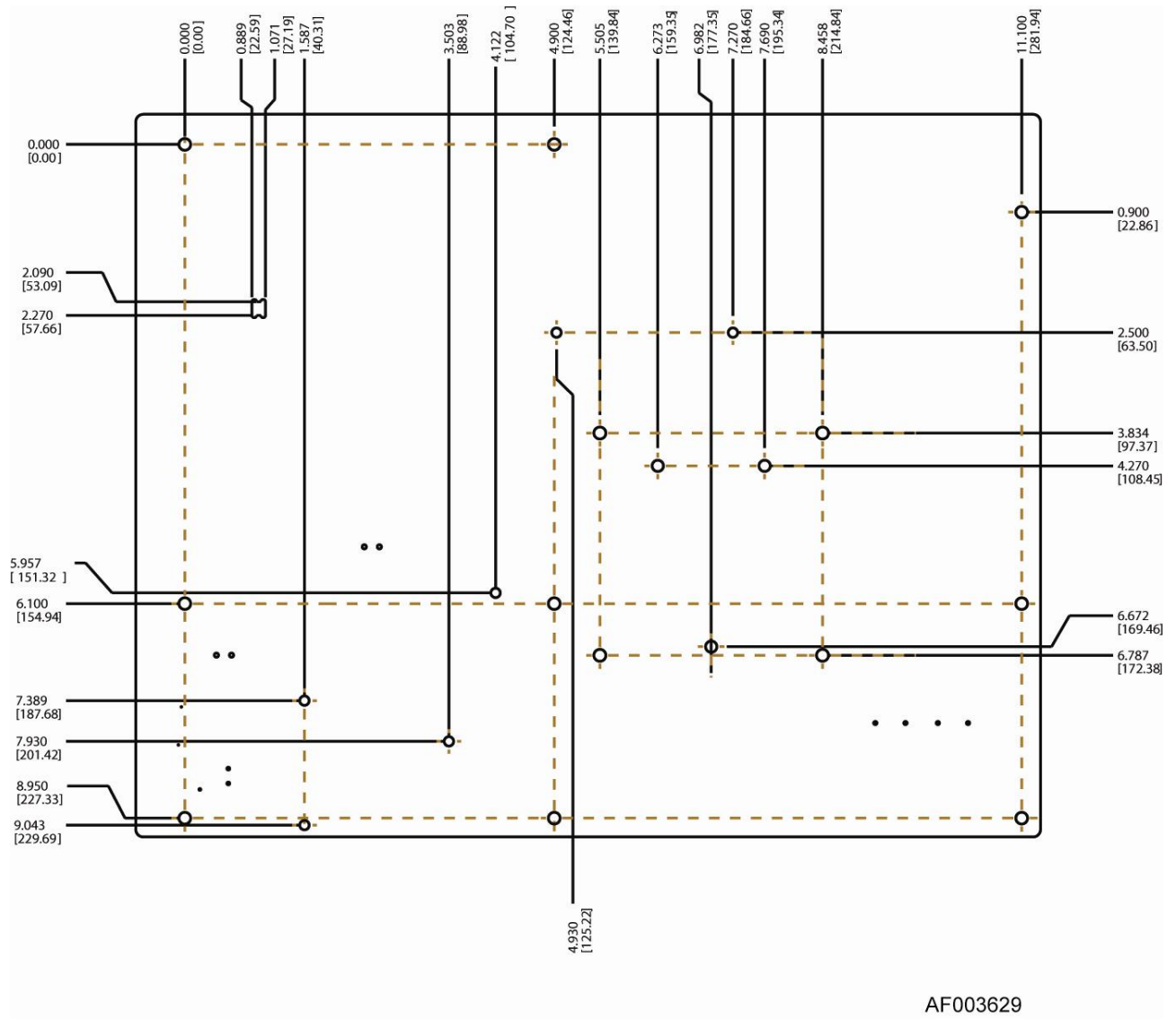
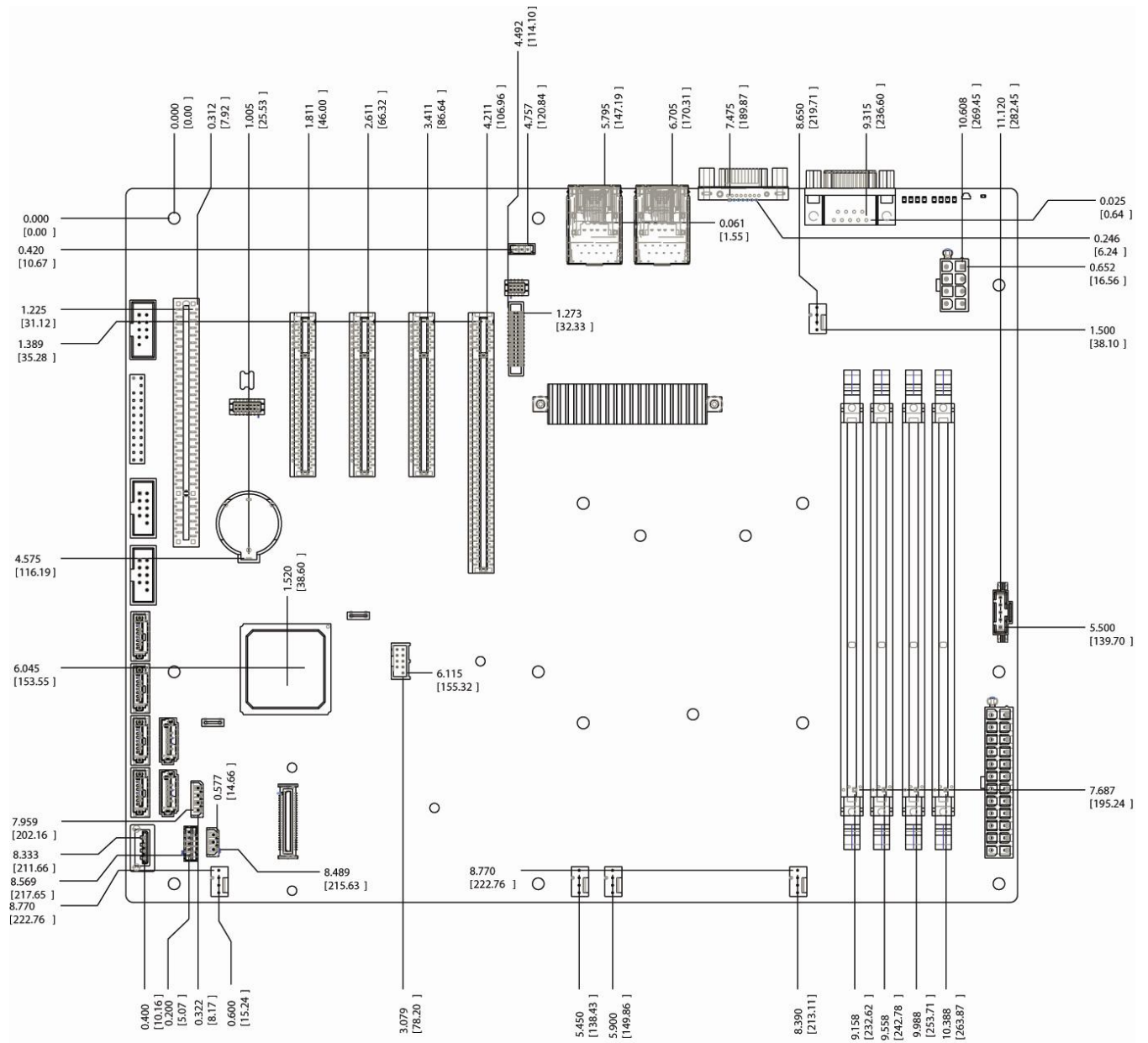

Figure 5. Intel® Server Board S1200BTL – Hole and Component Positions



AF003631

Figure 6. Intel® Server Board S1200BTL – Major Connector Pin Location (1 of 2)

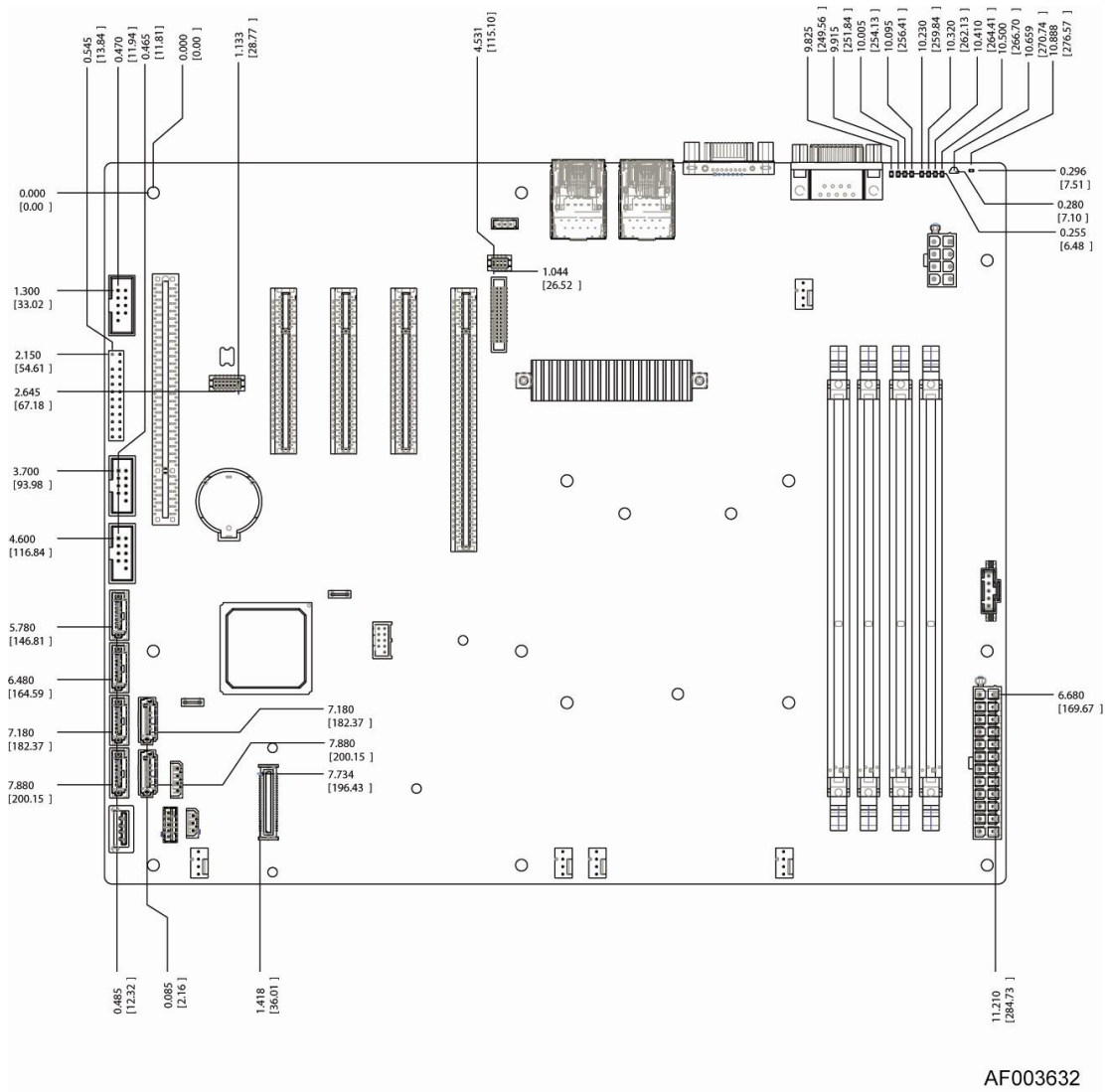
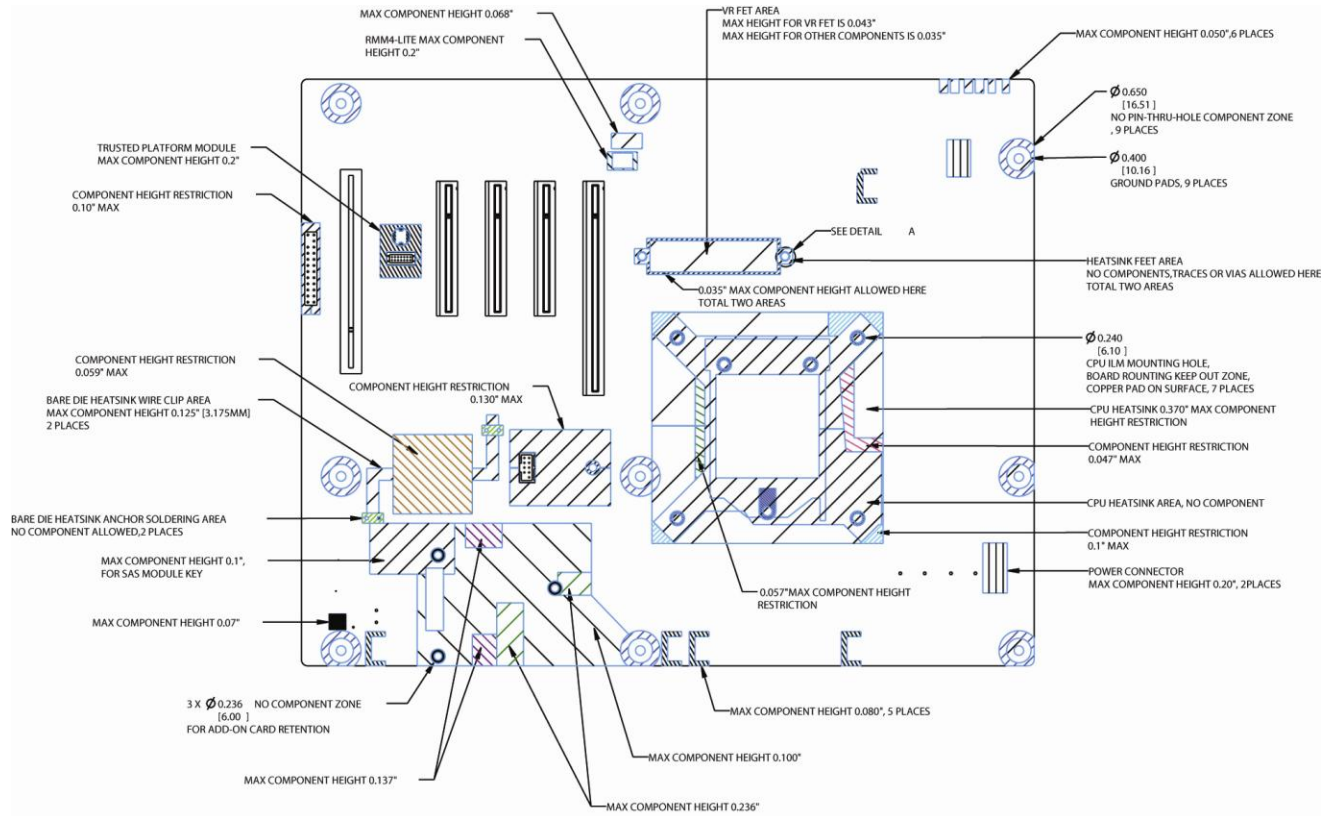

Figure 7. Intel® Server Board S1200BT – Major Connector Pin Location (2 of 2)



AF003633

Figure 8. Intel® Server Board S1200BTL – Primary Side Keepout Zone

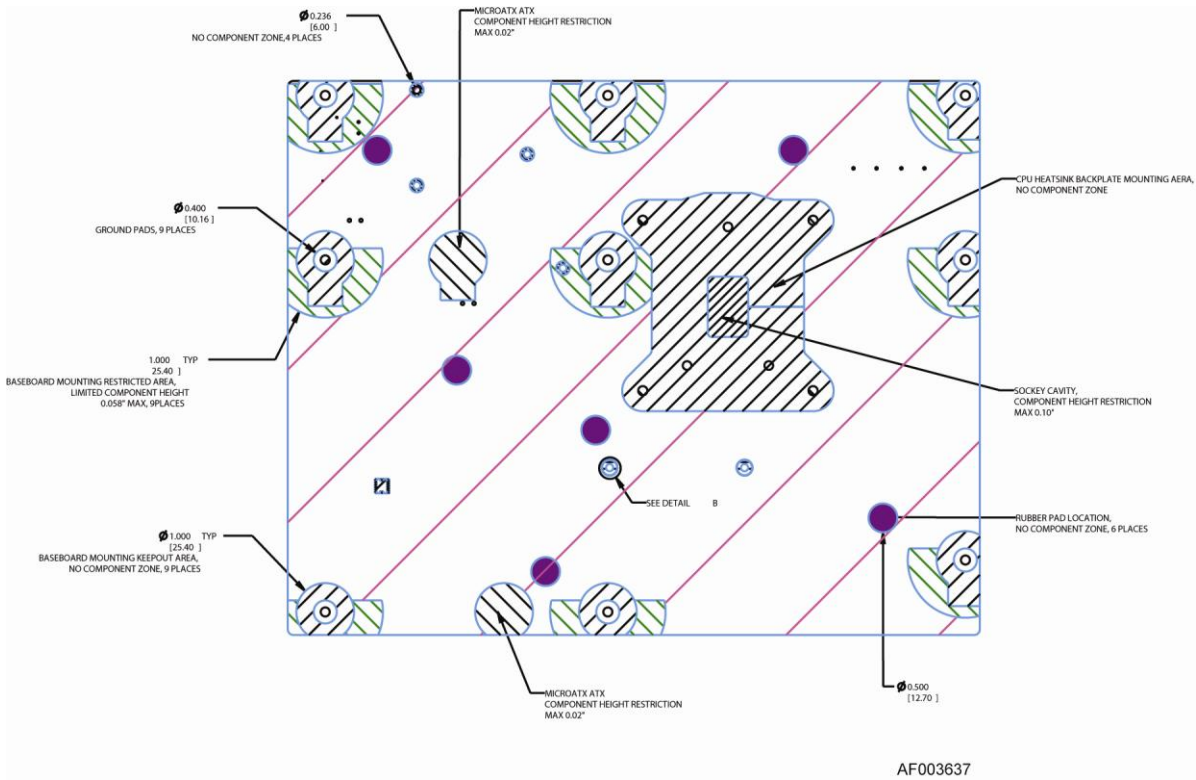
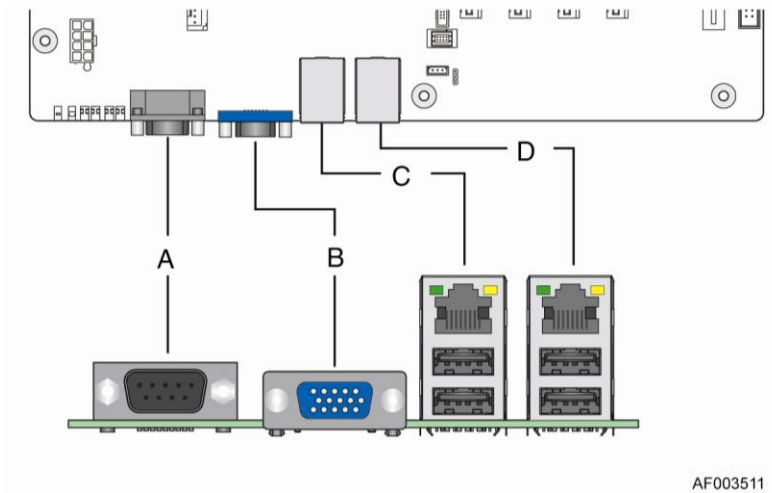

Figure 9. Intel® Server Board S1200BTL – Secondary Side Keepout Zone

2.2.3 Server Board Rear I/O Layout

The following figure shows the layout of the rear I/O components for the server board.



A	Serial Port A	C	NIC Port 1 (1 Gb) and Dual USB Port Connector
B	Video	D	NIC port 2 (1 Gb) and Dual USB Port Connector

Figure 10. Intel® Server Board S1200BT Rear I/O Layout

3. Functional Architecture

The architecture and design of the Intel® Server Board S1200BT is based on the Intel® C202 Chipset. The chipset is designed for systems based on the Intel® Xeon® processor in the FC-LGA 1155 socket package.

The Intel® Server Board S1200BTL uses Intel® C204 Chipset and the Intel® Server Board S1200BTS uses Intel® C202 Chipset.

The Intel® Xeon® Processor E3-1200 Series are made up of multi-core processors based on the 32nm processor technology. The Intel® Core™ Processor i3-2100 is made up of dual-core processors based on the 32nm processor technology.

This chapter provides a high-level description of the functionality associated with each chipset component and the architectural blocks that make up the server board.

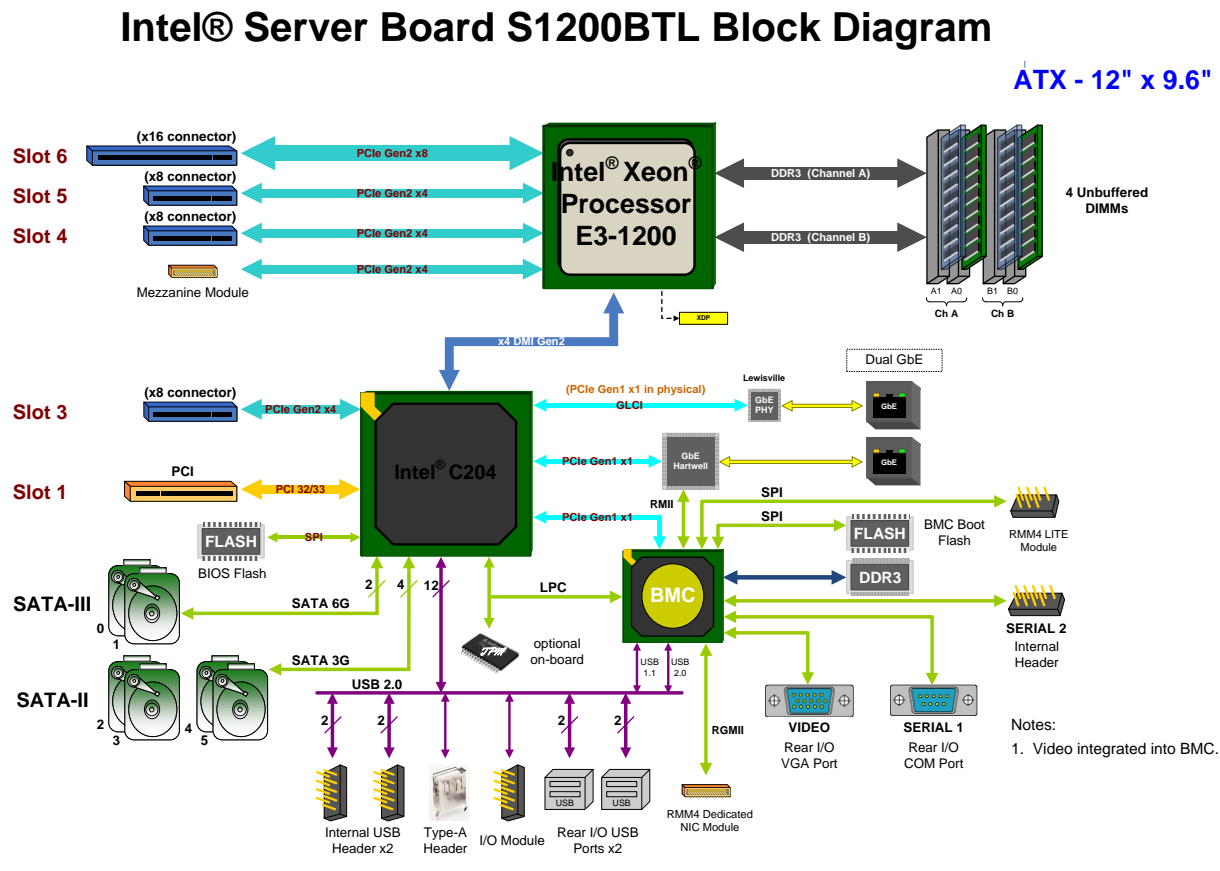

Figure 11. Intel® Server Board S1200BTL Functional Block Diagram

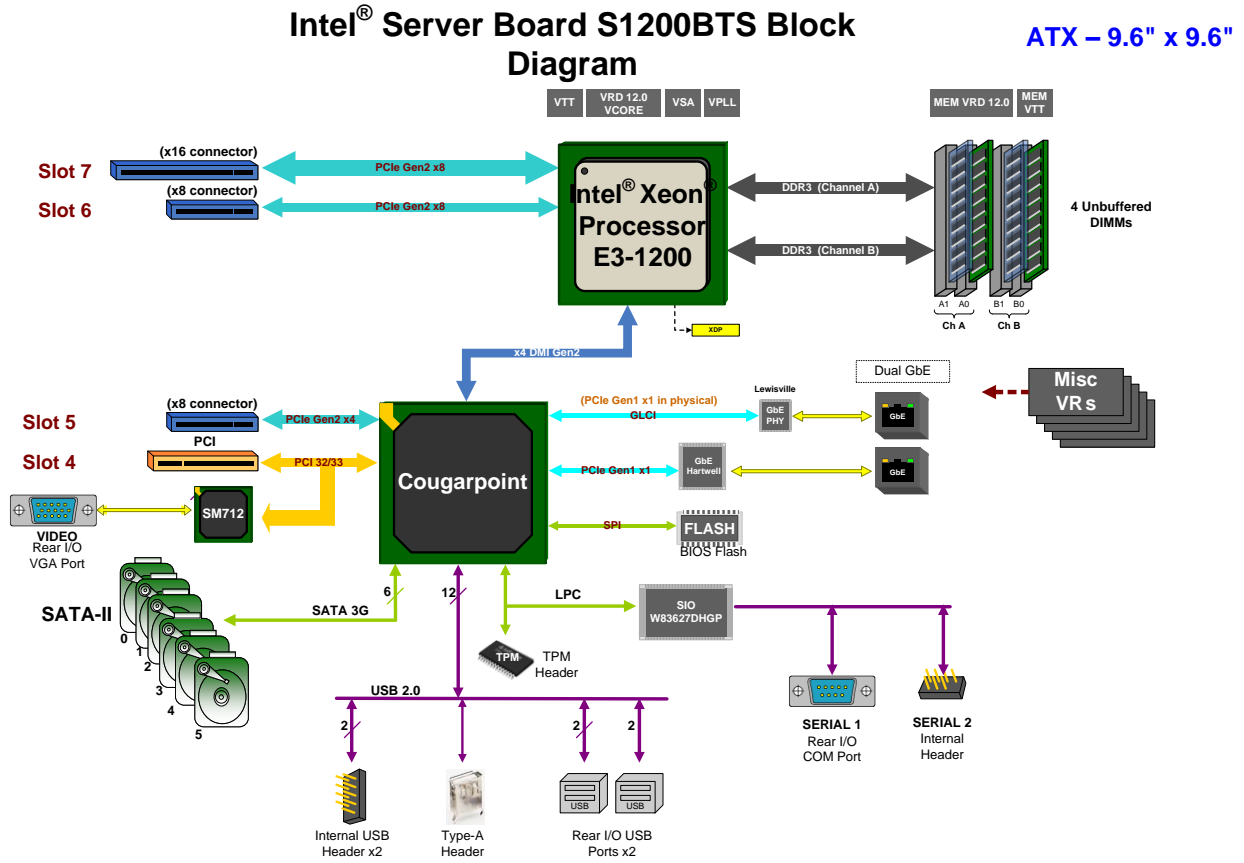

Figure 12. Intel® Server Board S1200BTS Functional Block Diagram

3.1 Processor Sub-System

The Intel® Server Board S1200BT supports the following processor:

- Intel® Xeon® Processor E3-1200 Series.
- Intel® Core™ Processor i3-2100 Series

The Intel® Xeon® Processor E3-1200 Series are made up of multi-core processors based on the 32 nm processor technology. Intel® Core™ Processor i3-2100 Series are made up of dual-core processors based on the 32nm processor technology.

3.1.1 Intel® Xeon® Processor E3-1200 Series

The Intel® Xeon® Processor E3-1200 Series highly integrated solution variant is composed of quad processor cores.

- FC-LGA 1155 socket package with 2.5 GT/s.
- Up to 95 W Thermal Design Power (TDP); processors with higher TDP are not supported.

The server board does not support previous generations of the Intel® Xeon® processors. The list of supported processors may be found at <http://serverconfigurator.intel.com>.

Note: The workstation processor is not supported in this platform.

3.1.2 Intel® Core™ Processor i3-2100 Series

The Intel® Core™ Processor i3-2100 Series highly integrated solution variant is composed of Duo cores.

- FC-LGA 1155 socket package with 2.5 GT/s.
- Up to 65 W Thermal Design Power (TDP); processors with higher TDP are not supported.

The server board does not support previous generations of the Intel® Core™ Processor i3 Series.

The list of supported processors may be found at <http://serverconfigurator.intel.com>.

3.1.3 Intel® Turbo Boost Technology

Intel® Turbo Boost Technology is featured on certain processors in the Intel® Xeon® Processor E3-1200 Series. Intel® Turbo Boost Technology opportunistically and automatically allows the processor to run faster than the marked frequency if the processor is operating below power, temperature, and current limits. This results in increased performance for both multi-threaded and single-threaded workloads.

Intel® Turbo Boost Technology operation:

- Turbo Boost operates under Operating System control – It is only entered when the operating system requests the highest (P0) performance state.
- Turbo Boost operation can be enabled or disabled in BIOS Setup.
- Turbo Boost converts any available power and thermal headroom into a higher frequency on active cores. At nominal marked processor frequency, many applications consume less than the rated processor power draw.
- Turbo Boost availability is independent of the number of active cores.
- Maximum Turbo Boost frequency depends on the number of active cores and varies by processor configuration.
- The amount of time the system spends in Turbo Boost operation depends on workload, operating environment, and platform design.

If the processor supports the Intel® Turbo Boost Technology feature, the BIOS Setup provides an option to enable or disable this feature. The default state is enabled.

3.2 Memory Subsystem

The Intel® Xeon® Processor E3-1200 series or Intel® Core™ Processor i3-2100 has an Integrated Memory Controller (IMC) in its package. Each processor produces up to two DDR3 channels of memory. Each DDR3 channel in the IMC supports up to two UDIMM slots. The DDR3 UDIMM frequency can be 1066/1333 MHz. Only ECC memory is supported on this platform.

- The memory channels are named as “Channel A” and “Channel B”.
- The memory slots are named as “Slot1” and “Slot2” on each channel. Slot1 will be the farthest from the processor socket.
- DIMMs are named to reflect the channel and slot in which they are installed:
 - Channel A, Slot1 is “DIMM_A1”.
 - Channel A, Slot2 is “DIMM_A2”.
 - Channel B, Slot1 is “DIMM_B1”.
 - Channel B, Slot2 is “DIMM_B2”.

3.2.1 Memory Supported

The Intel® Server Board S1200BT family supports various DDR3 DIMM modules of different types and sizes and speeds.

In this section, the statements of support are subject to qualification in two ways:

For S1200 Server Boards with an SNB-DT processor, the Server Board and the BIOS may support:

- DIMMs composed of Dynamic Random Access Memory (DRAM) chips using 1 Gb, 2 Gb, or 4 Gb technology
- DIMMs using x8 DRAM technology only
- DIMMs organized as Single Rank (SR) or Dual Rank (DR)
- DIMM sizes of 1 GB, 2 GB, 4 GB, or 8 GB
- DIMM speeds of 1066 or 1333 MT/s (megatransfers/second)
- Only Unregistered (Unbuffered) DIMMs (UDIMMs) are supported
- Only Error Correction Code (ECC) enabled DIMMs are supported
- UDIMMs may or may not have thermal sensors

Note: UDIMMs must be ECC, and may or may not have thermal sensors.

S1200BT BIOS has the following limitations:

- No support for LV DIMMs
- No support for RDIMMs
- All channels in a system will run at the fastest common frequency
- Mixing ECC and non-ECC UDIMMs anywhere on the platform is not supported
- Static Closed Loop Thermal Throttling (CLTT) supported via BMC (requires ECC DIMMs with thermal sensor)

3.2.2 Post Error Codes

The range {0xE0 - 0xEF} of POST codes is used for memory errors in early POST. In late POST, this same range of POST code values is used for reporting other system errors.

- **0xE8 - No Usable Memory Error:** If no usable memory is available, the BIOS emits a beep code and displays POST Diagnostic LED code 0xE8 and halts the system.

This can also occur if all memory in the system fails and/or has become disabled during memory initialization. For example, if a DDR3 DIMM has no SPD information, the BIOS treats the DIMM slot as if no DDR3 DIMM is present on it. Therefore, if this is the only DDR3 DIMM installed in the system, there is no usable memory, and the BIOS goes to a memory error code 0xE8 as described above.

- **0xEA - Channel Training Error:** If the memory initialization process is unable to properly perform the Data/Data Strobe timing training on a memory channel, the BIOS emits a beep code and displays POST Diagnostic LED code 0xEA momentarily during the beeping. If there is usable memory in the system on other channels, POST memory initialization continues. Otherwise, the system beeps and halts with POST Diagnostic LED code 0xEA staying displayed.
- **0xEB - Memory Test Error:** If a DDR3 DIMM or a set of DDR3 DIMMs on the same memory channel fails memory testing but usable memory remains available, the BIOS emits a beep code and displays POST Diagnostic LED code 0xEB momentarily during the beeping, then continues POST. If all of the memory fails memory testing, then system memory error code 0xE8 (No Usable Memory) as described above.
- **0xED - Population Error:** If the installed memory contains an invalid DIMM configuration on any channel in the system, the system beeps and halts with POST Diagnostic LED code 0xED.

Note: Mixed DIMM configurations are not supported and not validated by Intel®.

3.2.3 Memory Map and Population Rules

The overall configuration is a single processor with two channels, and two DIMM slots on each channel on the Intel® Server Board S1200BT. All memory DIMMs are ECC UDIMMs only, with a maximum size of 8 GB.

- Slot1 must be populated first before Slot2, on either channel.
- Channel A and Channel B are independent and are not required to have the same number of DIMMs installed. Either channel may be used for a single-DIMM configuration.
 - When only one memory channel is populated, the memory runs in Single Channel mode, with no interleaving.
 - When both channels are populated identically, the memory runs in Dual Channel Symmetric mode. The memory is interleaved by full 64-byte cache lines alternating between channels, i.e. the first entire cache line resides in DIMM_A1, the second in DIMM_B1, and so on. This allows Adjacent Cache Line Prefetch to fetch cache lines from both channels simultaneously, approximately doubling the potential memory bandwidth.
 - When both channels are populated, but with different numbers of DIMMs, Intel® Flex Memory Technology divides the installed memory into two zones, using interleaved Dual Channel Symmetric mode as far as the highest address on the less-populated channel, then using uninterleaved Dual Channel Asymmetric mode for the remaining memory on the more-populated channel.
- The maximum total installed memory size supported is 32 GB, using four 8 GB DIMMs.

- The maximum memory bandwidth is 10.6 GB/s in Single-Channel mode or 21 GB/s in Dual-Channel Symmetric mode, assuming DDR3 running at 1333 MT/s.

3.2.3.1 Memory Configuration Table

Table 4. Memory Configuration Table

Configuration	DIMM_A1	DIMM_A2	DIMM_B1	DIMM_B2
1 DIMM Single Channel	A1 only Single Channel			
1 DIMM Single Channel			B1 only Single Channel	
2 DIMMs Single Channel	A1 Single Channel	A2 Single Channel		
2 DIMMs Single Channel			B1 Single Channel	B2 Single Channel
2 DIMMs Dual Channel Symmetric	A1 Dual Channel Symmetric		B1 Dual Channel Symmetric	
3 DIMMs Intel® Flex Memory	A1 Dual Channel Symmetric	A2 Dual Channel Asymmetric	B1 Dual Channel Symmetric	
3 DIMMs Intel® Flex Memory	A1 Dual Channel Symmetric		B1 Dual Channel Symmetric	B2 Dual Channel Asymmetric
4 DIMMs Dual Channel Symmetric	A1 Dual Channel Symmetric	A2 Dual Channel Symmetric	B1 Dual Channel Symmetric	B2 Dual Channel Symmetric

3.2.3.2 DIMM Configuration rules

Table 5. UDIMM memory configuration rule

DIMM slots per channel	DIMMs populated per channel	Speed	Ranks per channel
2	1	1066, 1333	Single Rank, Dual Rank
2	2	1066, 1333	Single Rank, Dual Rank

To get the maximum memory size on UDIMM, you get the detailed information from following table:

Table 6. UDIMM Maximum configuration

Max Memory Possible	1Gb DRAM Technology	2Gb DRAM Technology	4Gb DRAM Technology
Single Rank UDIMM	4GB (4x 1GB DIMMs)	8GB (4x 2GB DIMMs)	16GB (4x 4GB DIMMs)
Dual Rank UDIMMs	8GB	16GB	32GB

Max Memory Possible	1Gb DRAM Technology	2Gb DRAM Technology	4Gb DRAM Technology
	(4x 2GB DIMMs)	(4x 4GB DIMMs)	(4x 8GB DIMMs)

3.2.4 Publishing System Memory

For **S1200 Server Boards** with an SNB-DT processor, the memory configurations and population rules are relatively simple. The overall configuration is a single processor/IMC, with two channels, and two DIMM slots on each channel. All memory DIMMs are ECC UDIMMs only, with a maximum size of 8 GB.

- Slot1 must be populated first before Slot2, on either channel.
- Channel A and Channel B are independent and are not required to have the same number of DIMMs installed. Either channel may be used for a single-DIMM configuration.
 - When only one memory channel is populated, the memory runs in Single Channel mode, with no interleaving.

3.2.5 Memory RAS Support

For Intel® Server Board S1200BT, the form of Memory RAS provided is Error Correction Code (ECC). ECC uses “extra bits” – 64-bit data in a 72-bit DRAM array – to add an 8-bit calculated “Hamming Code” to each 64 bits of data. This additional encoding enables the memory controller to detect and report single or double bit errors, and to correct single-bit errors.

There is a specific step in memory initialization in which all of memory is cleared to zeroes before the ECC function is enabled, in order to bring the ECC codes into agreement with memory contents.

During operation, in the process of every fetch from memory, the data and ECC bits are examined for each 64-bit data + 8-bit ECC group. If the ECC computation indicates that a single bit Correctable Error has occurred, it is corrected and the corrected data is passed on to the processor. If a double-bit Uncorrectable Error is detected, it cannot be corrected. In each case, a Correctable or Uncorrectable ECC Error event is generated.

For Correctable Errors, there is a certain tolerance observed, since a Correctable Error can be generated by something as random as a stray Cosmic Ray impacting the DIMM. Correctable Errors are counted on a per-DIMM basis, but are just silently recorded until the tolerance threshold is crossed. The Correctable Error Threshold for Intel® Server Board S1200BT board is set at 10 events. When the 10th CE occurs, a single Correctable Error event is logged.

3.3 Intel® Chipset PCH

The Intel® C200Series Chipset is designed for use with Intel® Xeon® Processor E3-1200 series or Intel® Core™ Processor i3-2100 in a UP server platform. The role of the PCH in the Intel® Server Board S1200BT is to manage the flow of information between its eleven interfaces, described below:

- DMI interface to Processor
- PCI Express* Interface
- PCI Interface
- Serial ATA Interface
- LPC Interface to IBMC and TPM
- USB host interface

- SMBus Host interface
- Serial Peripheral interface
- LAN interface
- ACPI interface

3.4 I/O Sub-system

Intel® C200 Series PCH provides extensive I/O support.

3.4.1 Digital Media Interface (DMI)

Direct Media Interface (DMI) is the chip-to-chip connection between the processor and C202 chipset. This high-speed interface integrates advanced priority-based servicing allowing for concurrent traffic and true isochronous transfer capabilities. Base functionality is completely software-transparent, permitting current and legacy software to operate normally.

3.4.2 PCI Express Interface

The PCI-E configurations for each SKU are defined below:

- Intel® Server Board S1200BTL
One PCI-E x16 connector to be used as a x8 link, two PCI-E x8 connectors to be used as a x4 link and one SAS module connector to be used as a x4 link connected to the PCI-E ports of the processor. One PCI-E x8 connector to be used as x4 link connected to the PC-E ports of PCH.
- Intel® Server Board S1200BTS
One PCI-E x16 connector to be used as x8 link, one PCI-E x8 connectors to be used as a x4 link connected to the PCI-E ports of the processor. One PCI-E x8 connector to be used as x4 link connected to the PC-E ports of PCH.

There is one 32-bit, 33-MHz 5-V PCI slot, common on both SKUs.

Compatibility with the PCI addressing model is maintained to ensure all existing applications and drivers operate unchanged.

The PCI Express* configuration uses standard mechanisms as defined in the PCI Plug-and-Play specification. The initial recovered clock speed of 1.25 GHz results in 2.5 Gb/s each direction, which provides a 250-MB/s communications channel in each direction (500 MB/s total). This is close to twice the data rate of classic PCI. It is a fact that 8b/10b encoding is used accounts for the 250 MB/s where quick calculations would imply 300 MB/s. The external graphics ports support 5.0 GT/s speed as well. Operating at 5.0 GT/s results in twice as much bandwidth per lane as compared to 2.5 GT/s operation.

When operating with two PCI Express* controllers, each controller can operate at either 2.5 GT/s or 5.0 GT/s. The PCI Express* architecture is specified in three layers: Transaction Layer, Data Link Layer, and Physical Layer. The partitioning in the component is not necessarily along these same boundaries.

3.4.3 Serial ATA Support

The Intel® C200 Series chipset has two integrated SATA host controllers that support independent DMA operation on up to six ports and supports data transfer rates of up to 6.0 Gb/s on up to two ports (Port 0 and 1 Only on S1200BTL) while all ports support rates up to 3.0 Gb/s. The SATA controller contains two modes of operation – a legacy mode using I/O space, and an

AHCI mode using memory space. Software that uses legacy mode will not have AHCI capabilities.

Software that uses legacy mode does not have Advanced Host Configuration Interface (AHCI) capabilities. The Intel® C202 PCH Chipset supports the Serial ATA Specification, Revision 1.0a. The PCH also supports several optional sections of the Serial ATA II: Extensions to Serial ATA 1.0 Specification, Revision 1.0 (AHCI support is required for some elements).

The Intel® C200 Series chipset PCH provides hardware support for AHCI, a standardized programming interface for SATA host controllers. Platforms supporting AHCI may take advantage of performance features such as no master/slave designation for SATA devices—each device is treated as a master – and hardware assisted native command queuing. AHCI also provides usability enhancements such as Hot-Plug. AHCI requires appropriate software support (e.g., an AHCI driver) and for some features, hardware support in the SATA device or additional platform hardware.

3.4.3.1 Intel® Matrix Storage Technology

The Intel® C200 Series chipset provides support for Intel® Rapid Storage Technology, providing both AHCI (see above for details on AHCI) and integrated RAID functionality. The RAID capability provides high-performance RAID 0, 1, 5, and 10 functionality on up to 6 SATA ports of the PCH. Matrix RAID support is provided to allow multiple RAID levels to be combined on a single set of hard drives, such as RAID 0 and RAID 1 on two disks. Other RAID features include hot spare support, SMART alerting, and RAID 0 auto replace. Software components include an Option ROM for pre-boot configuration and boot functionality, a Microsoft Windows* compatible driver, and a user interface for configuration and management of the RAID capability of PCH.

3.4.4 Low Pin Count (LPC) Interface

The Intel® C200 Series chipset implements an LPC Interface as described in the LPC 1.1 Specification. The Low Pin Count (LPC) bridge function of the C202 resides in PCI Device 31: Function 0. In addition to the LPC bridge interface function, D31:F0 contains other functional units including DMA, interrupt controllers, timers, power management, system management, GPIO, and RTC.

3.4.5 USB 2.0 Support

On the Intel® C200 series PCH Chipset, the USB controller functionality is provided by the dual EHCI controllers with an interface for up to ten USB 2.0 ports. All ports are high-speed, full-speed, and low-speed capable.

- Four external connectors are located on the back edge of the server board.
- Two internal 2x5 headers (J1E1 and J1D1) are provided, each supporting two optional USB 2.0 ports.
- One port on internal smart module connector (J1J2) on Intel® Server Board S1200BTL.

3.4.5.1 Native USB Support

During the power-on self test (POST), the BIOS initializes and configures the USB subsystem. The BIOS is capable of initializing and using the following types of USB devices.

- USB Specification-compliant keyboards.
- USB Specification-compliant mouse.
- USB Specification-compliant storage devices that utilize bulk-only transport mechanism.

USB devices are scanned to determine if they are required for booting.

The BIOS supports USB 2.0 mode of operation, and as such supports USB 1.1 and USB 2.0 compliant devices and host controllers.

During the pre-boot phase, the BIOS automatically supports the hot addition and hot removal of USB devices and a short beep is emitted to indicate such an action. For example, if a USB device is hot plugged, the BIOS detects the device insertion, initializes the device, and makes it available to the user. During POST, when the USB controller is initialized, it emits a short beep for each USB device in the system as if they were all just “hot added”.

Only on-board USB controllers are initialized by BIOS. This does not prevent the operating system from supporting any available USB controllers including add-in cards.

3.4.5.2 Legacy USB Support

The BIOS supports PS/2 emulation of USB keyboards and mouse. During POST, the BIOS initializes and configures the root hub ports and searches for a keyboard and/or a mouse on the USB hub and then enables the devices that are recognized.

3.5 Optional Intel® SAS RAID Module

The Intel® Server Board S1200BTL provides a SAS Mezzanine slot (J2H1) for the installation of an optional Intel® SAS RAID Module. Once the optional Intel® SAS Entry RAID Module is detected, the x4 PCI Express* links from the chipset to the SAS Mezzanine slot. Four modules are supported in this platform: AXXRMS2AF040, AXXRMS2LL040 and AXX4SASMOD.

3.6 Integrated Baseboard Management Controller

The Intel® Server Board S1200BTL has the highly integrated single-chip baseboard management controller based on ServerEngines* Pilot III, but Intel® Server Board S1200BTS does not have the integrated baseboard management control.

This Intel® Integrated BMC contains the following integrated subsystems and features.

The following is a summary of the BMC management hardware features used by the BMC:

- 400MHz 32-bit ARM9 processor with memory management unit (MMU)
- Two independent 10/100/1000 Ethernet Controllers with RMII (Reduced Media Independent Interface)/RGMII (Reduced Gigabit Media-Independent Interface) support
- DDR2/3 16-bit interface with up to 800 MHz operation
- 12 10-bit Analog to Digital Converters
- Sixteen fan tachometers
- Eight Pulse Width Modulators (PWM)
- Chassis intrusion logic
- JTAG Master

- Eight I2C interfaces with master-slave and SMBus timeout support. All interfaces are SMBus 2.0 compliant.
- Parallel general-purpose I/O Ports (16 direct, 32 shared)
- Serial general-purpose I/O Ports (80 in and 80 out)
- Three UARTs
- Platform Environmental Control Interface (PECI)
- Six general-purpose timers
- Interrupt controller
- Multiple SPI flash interfaces
- NAND/Memory interface
- Sixteen mailbox registers for communication between the Integrated BMC and host
- LPC ROM interface
- Integrated BMC watchdog timer capability
- SD/MMC card controller with DMA support
- LED support with programmable blink rate controls on GPIOs
- Port 80h snooping capability
- Secondary Service Processor (SSP), which provides the HW capability of offloading time critical processing tasks from the main ARM core.

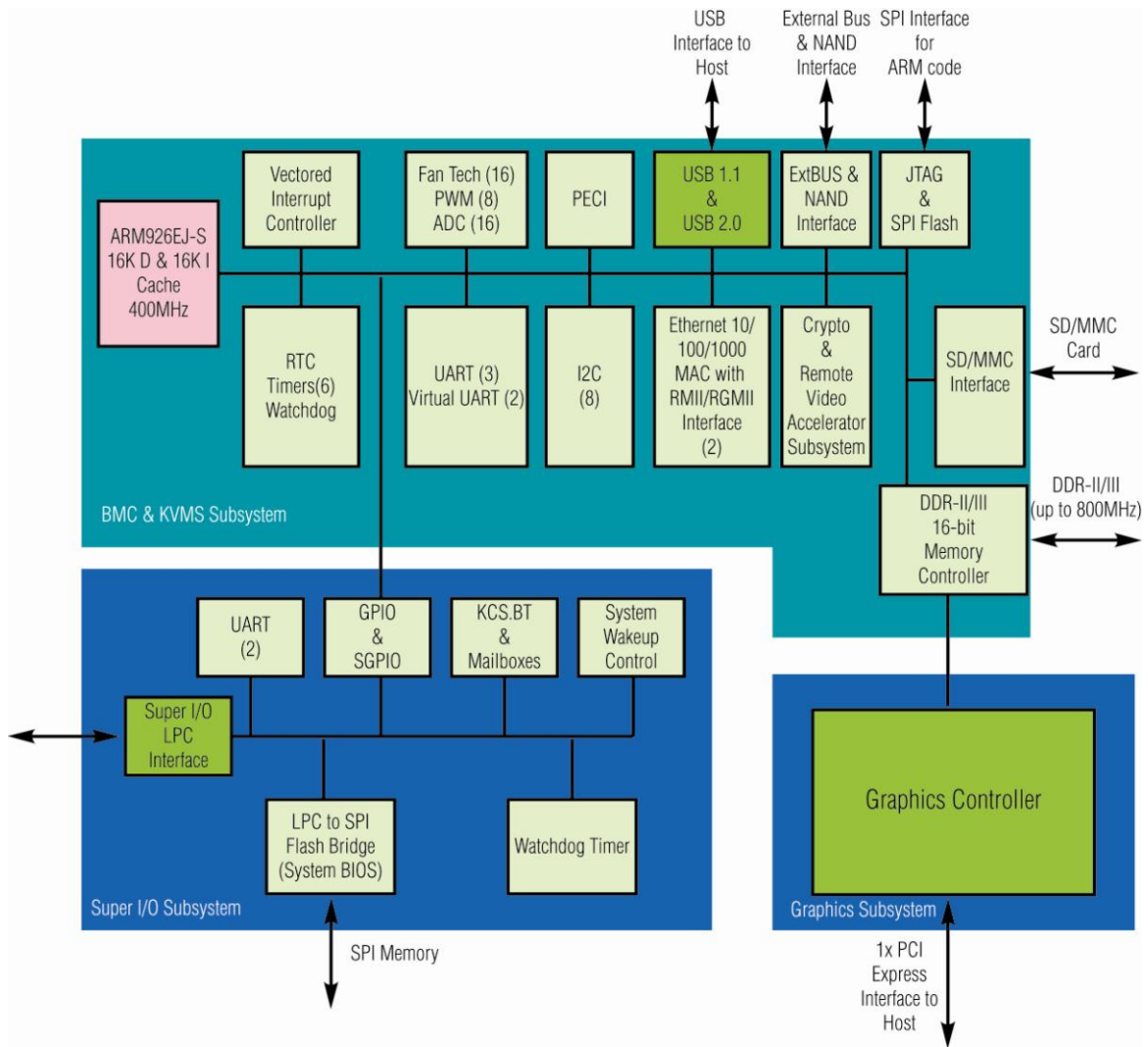

Figure 13. Integrated BMC Hardware

3.6.1 Integrated BMC Embedded LAN Channel

The Integrated BMC hardware includes two dedicated 1000M network interfaces.

Interface 1: This interface is available from either of the available NIC ports in system that can be shared with the host. Only one NIC may be enabled for management traffic at any time. To change the NIC enabled for management traffic, please use the “Write LAN Channel Port” OEM IPMI command. The default active interface is port 1 (NIC1).

Interface 2: This interface is available from the optional RMM4 which is a dedicated management NIC that is not shared with the host.

For these channels, support can be enabled for IPMI-over-LAN and DHCP.

For security reasons, embedded LAN channels have the following default settings:

- IP Address: Static

- All users disabled

3.6.2 Optional RMM4 Advanced Management Board

On the Intel® Server Board S1200BTL provides RMM4 module.

- Give the customer the option to add a dedicated management 100 Mbit LAN interface to the product.
- Provide additional flash space, enabling the Advanced Management functions to support WS-MAN and CIMON.

Table 7. Optional RMM4 Advanced Management Board Features

Feature	Description
KVM Redirection	Remote console access via keyboard, video, and mouse redirection over LAN.
USB Media Redirection	Remote USB media access over LAN.
WS-MAN	Full SMASH profiles for WS-MAN based consoles.

3.6.3 Serial Ports

The server board provides two serial ports: an external DB9 serial port connector and an internal DH-10 serial header.

The rear DB9 Serial A port is a fully functional serial port that can support any standard serial device.

The Serial B port is an optional port accessed through a 9-pin internal DH-10 header (J1B1 on S1200BTL; J8A1 on S1200BTS). You can use a standard DH-10 to DB9 cable to direct serial A port to the rear of a chassis. The serial B interface follows the standard RS-232 pin-out as defined in the following table:

Table 8. Serial B Header (J1B2 on S1200BTL or J8A1 on S1200BTS) Pin-out

Pin	Signal Name	Serial Port B Header Pin-out
1	DCD	
2	DSR	
3	RX	
4	RTS	
5	TX	
6	CTS	
7	DTR	
8	RI	
9	GND	

3.6.4 Floppy Disk Controller

The server board does not support a floppy disk controller interface. However, the system BIOS recognizes USB floppy devices.

3.6.5 Keyboard and Mouse Support

The server board does not support PS/2 interface keyboards and mouse. However, the system BIOS recognizes USB specification-compliant keyboard and mouse.

3.6.6 Wake-up Control

The super I/O contains functionality that allows various events to power on and power off the system.

3.7 Video Support

3.7.1 Intel® Server Board S1200BTL

The server board includes on-board Server Engine* LLC Pilot III* Controller with 128 MB DDR3 memory in which 8MB is usable/accessible memory for iBMC video/graphic display functions. The graphic controller internally has access to larger memory for the internal operations. The 32MB memory reported by display driver is the attached memory. Attached memory can be 32MB or greater but only 8MB is accessible for display functions.

3.7.1.1 Video Modes

The integrated video controller supports all standard IBM VGA modes. The following table shows the 2D modes supported for both CRT and LCD.

Table 9. Video Modes

2D Mode	Refresh rate	8bpp	16bpp	32bpp
640 x 480	60, 70, 72, 75, 85, 90, 100, 200	supported	Supported	Supported
800 x 600	60, 70, 72, 75, 85, 90, 100,120, 160	Supported	Supported	Supported
1024 x 768	60, 70, 72, 75, 85, 90, 100	Supported	Supported	Supported
1152 x 852	43, 47, 60, 70, 75, 80, 85	Supported	Supported	Supported
1280 x 1024	60, 70, 74, 75	Supported	Supported	Supported
1600 x 1200	52	Supported	Supported	Supported

3.7.1.2 Dual Video

The BIOS supports both single-video and dual-video modes. The dual-video mode is disabled by default.

- In the single mode (dual monitor video = disabled), the on-board video controller is disabled when an add-in video card is detected.
- In single mode, the onboard video controller is disabled when an add-in video card is detected.

- In dual mode, the onboard video controller is enabled and is the primary video device. The external video card is allocated resources and is considered the secondary video device.
- When KVM is enabled in iBMC FW, dual video is enabled.

Table 10. Dual Video Modes

Onboard Video	Enabled Disabled	Onboard video controller. Warning: System video is completely disabled if this option is disabled and an add-in video adapter is not installed.
Dual Monitor Video	Enabled Disabled	If enabled, both the onboard video controller and an add-in video adapter are enabled for system video. The onboard video controller becomes the primary video device.

3.7.2 Video for Intel® Server Board S1200BTS

SM712 is a video chip from Silicon Motion, Inc (SMI). It is one in SMI's LynxEM family. It is PCI 2.1 compliant with the standard PCI 33MHz & 66 MHz PCI Master/Slave interface.

- 33 MHz & 66 MHz PCI Master/Slave interface
- PCI 2.1 compliant
- Memory control is provided for the 4MB internal memory
- Support 640x480, 800x600, 1024x768 resolution and up to 85Hz.
- Dual Video mode is supported.

3.8 Network Interface Controller (NIC)

The Intel® Server Board S1200BT supports two network interfaces, One is provided from the onboard Intel® 82574L GbE PCI Express network controller; the other is the onboard Intel® 82579 Gigabit Network controller.

3.8.1 Gigabit Ethernet Controller 82574L

The 82574 family (82574L and 82574IT) are single, compact, low-power components that offer a fully-integrated Gigabit Ethernet Media Access Control (MAC) and Physical Layer (PHY) port. The 82574 uses the PCI Express* architecture and provides a single-port implementation in a relatively small area so it can be used for server and client configurations as a LAN on Motherboard (LOM) design.

External interfaces provided on the 82574:

- PCIe Rev. 2.0 (2.5 GHz) x1
- MDI (Copper) standard IEEE 802.3 Ethernet interface for 1000BASE-T, 100BASETX, and 10BASE-T applications (802.3, 802.3u, and 802.3ab)
- NC-SI or SMBus connection to a Manageability Controller (MC)
- EEE 1149.1 JTAG (note that BSDL testing is NOT supported)

3.8.2 Gigabit Ethernet PHY 82579

The 82579 is a single port Gigabit Ethernet Physical Layer Transceiver (PHY). It connects to the Intel® C200 series Chipset's integrated Media Access Controller (MAC) through a dedicated interconnect. The 82579 supports operation at 1000/100/10 Mb/s data rates. The PHY circuitry

provides a standard IEEE 802.3 Ethernet interface for 1000BASE-T, 100BASE-TX, and 10BASE-T applications (802.3, 802.3u, and 802.3ab). Lewisville also supports the Energy Efficient Ethernet (EEE) 802.az specification.

The 82579 operates with the Platform Controller Hub (PCH) chipset that incorporates the MAC and interfaces with its integrated LAN controller through two interfaces: PCIebased and SMBus. The PCIe (main) interface is used for all link speeds when the system is in an active state (S0) while the SMBus is used only when the system is in a low power state (Sx). In SMBus mode, the link speed is reduced to 10 Mb/s (dependent on low power options). The PCIe interface incorporates two aspects: a PCIe SerDes (electrically) and a custom logic protocol.

3.8.3 MAC Address Definition

Each Intel® Server Board S1200BTL has the following four MAC addresses assigned to it at the Intel® factory:

- NIC 1 MAC address
- NIC 2 MAC address – Assigned the NIC 1 MAC address +1
- Integrated BMC LAN Channel MAC address – Assigned the NIC 1 MAC address +2
- Intel® Remote Management Module 4 dedicated NIC MAC address – Assigned the NIC 1 MAC address +3

Each Intel® Server Board S1200BTS has the following two MAC addresses assigned to it at the Intel® factory:

- NIC 1 MAC address
- NIC 2 MAC address – Assigned the NIC 1 MAC address +1

3.9 Intel® I/O Acceleration Technology 2 (Intel® I/OAT2)

Intel® I/O AT2 is not supported.

3.9.1 Direct Cache Access (DCA)

Direct Cache Access (DCA) is not supported on Intel® Xeon® Processor E3-1200 Series.

3.10 Intel® Virtualization Technology for Directed I/O (Intel® VT-d)

The Intel® C202 chipset provides hardware support for implementation of Intel® Virtualization Technology with Directed I/O (Intel® VT-d). Intel® VT-d Technology consists of technology components that support the virtualization of platforms based on Intel® Architecture Processors. Intel® VT-d technology enables multiple operating systems and applications to run in independent partitions. A partition behaves like a virtual machine (VM) and provides isolation and protection across partitions. Each partition is allocated its own subset of host physical memory.

Note: If the setup options are changed to enable or disable the Virtualization Technology setting in the processor, the user must perform an AC power cycle for the changes to take effect.

3.11 TPM (Trusted Platform Module)

There is one TPM module connector. The detail information is listed below:

- Embedded TPM 1.2 firmware
- 33-MHz Low Pin Count (LPC) interface V1.1
- Compliant with TCG PC client specific TPM Implementation Specification (TIS) V1.2

For the detail Intel® TPM module, please refer to TPM module user guide.

4. Platform Management

This chapter is only for The Intel® Server Board S1200BTL.

The platform management subsystem is based on the Integrated BMC features of the ServerEngines* Pilot III. The onboard platform management subsystem consists of communication buses, sensors, system BIOS, and server management firmware. The following diagram provides an overview of the Server Management Bus (SMBUS) architecture used on this server board.

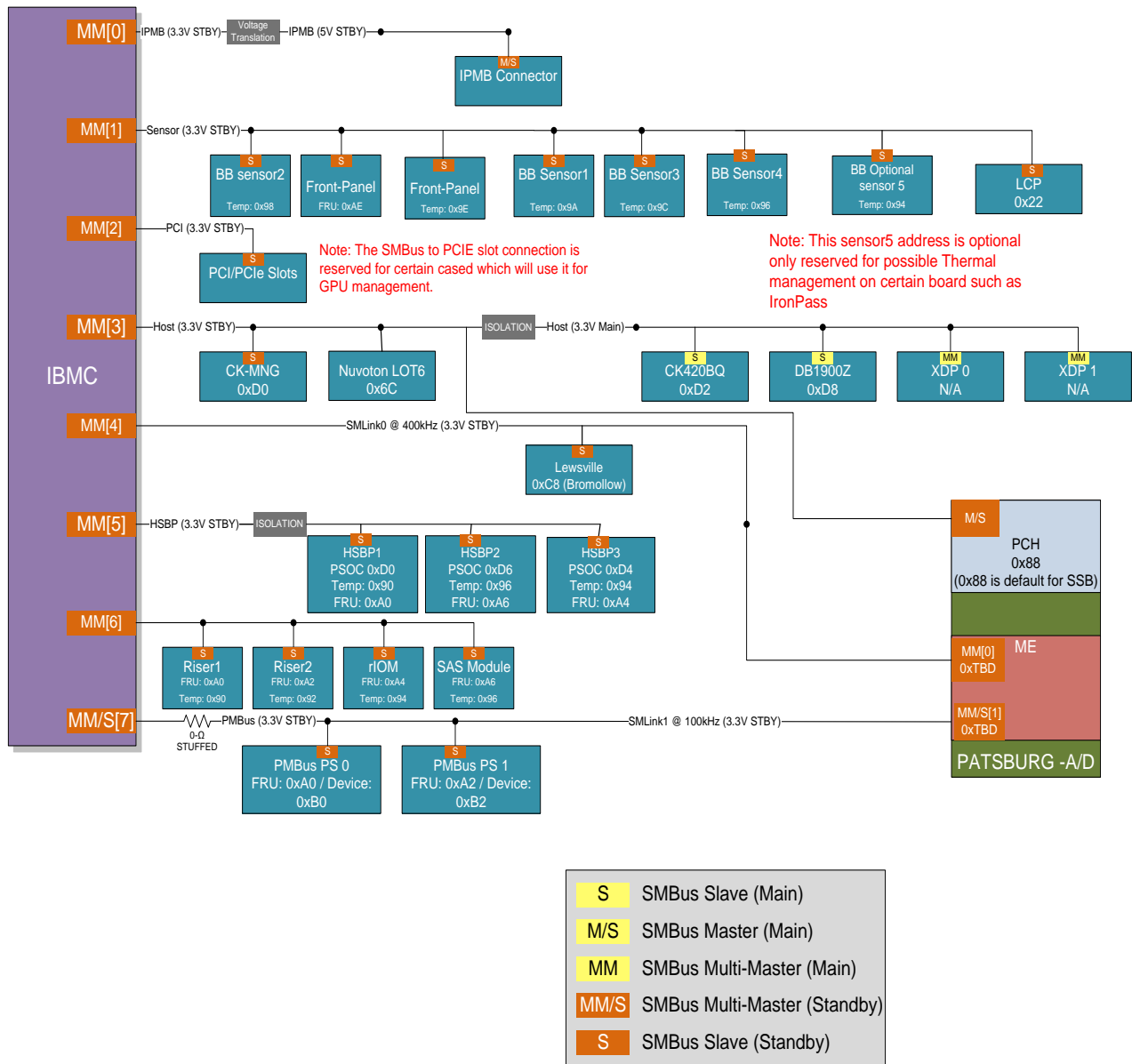

Figure 14. Server Management Bus (SMBUS) Block Diagram

4.1 Feature Support

4.1.1 IPMI 2.0 Features

- Baseboard management controller (BMC).
- IPMI Watchdog timer
- Messaging support, including command bridging and user/session support
- Chassis device functionality, including power/reset control and BIOS boot flags support
- Event receiver device: The BMC receives and processes events from other platform subsystems.
- Field replaceable unit (FRU) inventory device functionality: The BMC supports access to system FRU devices using IPMI FRU commands.
- System event log (SEL) device functionality: The BMC supports and provides access to a SEL.
- Sensor data record (SDR) repository device functionality: The BMC supports storage and access of system SDRs.
- Sensor device and sensor scanning/monitoring: The BMC provides IPMI management of sensors. It polls sensors to monitor and report system health.
- IPMI interfaces
 - Host interfaces include system management software (SMS) with receive message queue support, and server management mode (SMM)
 - IPMB interface
 - LAN interface that supports the IPMI-over-LAN protocol (RMCP, RMCP+)
- Serial-over-LAN (SOL)
- ACPI state synchronization: The BMC tracks ACPI state changes that are provided by the BIOS.
- BMC self test: The BMC performs initialization and run-time self-tests and makes results available to external entities.

Please see the Intelligent Platform Management Interface Specification Second Generation v2.0 for detail information.

4.1.2 Non-IPMI Features

The BMC supports the following non-IPMI features. This list does not preclude support for future enhancements or additions.

- In-circuit BMC firmware update
- Fault resilient booting (FRB): FRB2 is supported by the watchdog timer functionality.
- Chassis intrusion detection
- Basic fan control using TControl version 2 SDRs
- Power supply redundancy monitoring and support
- Hot-swap fan support
- Acoustic management: Support for multiple fan profiles
- Signal testing support: The BMC provides test commands for setting and getting platform signal states.

- The BMC generates diagnostic beep codes for fault conditions.
- System GUID storage and retrieval
- Front panel management: The BMC controls the system status LED and chassis ID LED. It supports secure lockout of certain front panel functionality and monitors button presses. The chassis ID LED is turned on using a front panel button or a command.
- Power state retention
- Power fault analysis
- Intel® Light-Guided Diagnostics
- Power unit management: Support for power unit sensor. The BMC handles power-good dropout conditions.
- DIMM temperature monitoring: New sensors and improved acoustic management using closed-loop fan control algorithm taking into account DIMM temperature readings.
- Address Resolution Protocol (ARP): The BMC sends and responds to ARPs (supported on embedded NICs).
- Dynamic Host Configuration Protocol (DHCP): The BMC performs DHCP (supported on embedded NICs).
- Platform environment control interface (PECI) thermal management support
- E-mail alerting
- Embedded web server
- Integrated KVM.
- Integrated Remote Media Redirection
- Local Directory Access Protocol (LDAP) support
- Intel® Intelligent Power Node Manager support

4.1.3 New Manageability Features

This generation server products offer a number of changes and additions to the manageability features that are supported on the previous generation of servers. The following is a list of the more significant changes that are common to this generation servers:

- Sensor and SEL logging additions / enhancements (e.g. additional thermal monitoring capability, better isolation of faults to the FRU level)
- Embedded platform debug feature which allows capture of detailed data for later analysis by Intel® engineering.
- Provisioning and inventory enhancements:
 - Signed Firmware (improved security)
 - Inventory data / system information export (partial SMBIOS table)
- Enhancements to fan speed control.
- DCMI 1.0 compliance
- Support for embedded web server UI in Basic Manageability feature set.
- Enhancements to embedded web server
 - Human-readable SEL
 - Additional system configurability

- Additional system monitoring capability
- Enhanced on-line help
- Enhancements to KVM redirection
 - Support for higher resolution
- Management support for PMBus rev1.2 compliant power supplies
- Integrated BMC firmware reliability enhancements:
 - Redundant Integrated BMC boot blocks to avoid possibility of a corrupted boot block resulting in a scenario that prevents a user from updating the Integrated BMC.

4.2 Basic and Optional Advanced Management Features

This section explains the advanced management features supported by the Integrated Baseboard Management Controller (Integrated BMC) firmware.

This section explains the advanced management features supported by the BMC firmware.

Error! Reference source not found. lists basic and advanced feature support. Individual features may vary by platform. For more information, refer to Appendix D.

Table 11. Basic and Advanced Management Features

Feature	Basic*	Advanced**
IPMI 2.0 Feature Support	X	X
In-circuit BMC Firmware Update	X	X
FRB 2	X	X
Chassis Intrusion Detection	X	X
Fan Redundancy Monitoring	X	X
Hot-Swap Fan Support	X	X
Acoustic Management	X	X
Diagnostic Beep Code Support	X	X
Power State Retention	X	X
ARP/DHCP Support	X	X
PECI Thermal Management Support	X	X
E-mail Alerting	X	X
Embedded Web Server	X	X
SSH Support	X	X
Integrated KVM		X
Integrated Remote Media Redirection		X
Local Directory Access Protocol (LDAP)	X	X
Intel® Intelligent Power Node Manager Support***	X	X
SMASH CLP	X	X

* Basic management features provided by Integrated BMC

**Advanced management features available with optional Intel® Remote Management Module 4

***Intel® Intelligent Power Node Manager Support requires PMBus-compliant power supply

4.2.1 Enabling Advanced Management Features

The Advanced management features are to be delivered as part of the Integrated BMC firmware image. The Integrated BMC's baseboard SPI flash contains code/data for both the Basic and Advanced features. An optional add-in card Intel® RMM4-lite is used as the activation

mechanism. When the Integrated BMC firmware initializes, it attempts to access the Intel® RMM4-lite. If the attempt to access Intel® RMM4-lite is successful, then the Integrated BMC activates the advanced features.

Advanced manageability features are supported over all NIC ports enabled for server manageability. This includes baseboard NICs as well as the LAN channel provided by the optional Dedicated NIC add-in card.

There are two RMM4 SKUs:

- Intel® RMM4-lite – Advance features enabled but no dedicated management NIC.
- Intel® RMM4 – Advance features enabled with a dedicated management NIC. It is a package that contains two modules: Intel® Dedicated Server Management NIC and Intel® RMM4-lite.

4.2.2 Keyboard, Video, and Mouse (KVM) Redirection

The BMC firmware supports keyboard, video, and mouse redirection (KVM) over LAN. This feature is available remotely from the embedded web server as a Java applet. This feature is enabled when the Intel® RMM4 is present. The client system must have a Java Runtime Environment (JRE) version 5.0 or later to run the KVM or media redirection applets.

The Integrated BMC supports an embedded KVM application (Remote Console) that can be launched from the embedded web server from a remote console. USB1.1 or USB 2.0 based mouse and keyboard redirection are supported. It is also possible to use the KVM-redirection (KVM-r) session concurrently with media-redirection (media-r). This feature allows a user to interactively use the keyboard, video, and mouse (KVM) functions of the remote server as if the user were physically at the managed server.

The KVM-redirection feature automatically senses video resolution for best possible screen capture and provides high-performance mouse tracking and synchronization. It allows remote viewing and configuration in pre-boot POST and BIOS setup, once BIOS has initialized video.

Other attributes of this feature include:

- Encryption of the redirected screen, keyboard, and mouse
- Compression of the redirected screen

4.2.2.1 Remote Console

The Remote Console is the redirected screen, keyboard and mouse of the remote host system. To use the Remote Console window of your managed host system, the browser must include a Java* Runtime Environment plug-in. If the browser has no Java support, such as with a small handheld device, the user can maintain the remote host system using the administration forms displayed by the browser.

The Remote Console window is a Java Applet that establishes TCP connections to the Integrated BMC. The protocol that is run over these connections is a unique KVM protocol and not HTTP or HTTPS. This protocol uses ports #7578 for KVM, #5120 for CDROM media redirection, and #5123 for Floppy/USB media redirection (both supporting encryption).

4.2.2.2 Performance

The remote display accurately represents the local display. The feature adapts to changes to the video resolution of the local display and continues to work smoothly when the system transitions from graphics to text or vice-versa. The responsiveness may be slightly delayed depending on the bandwidth and latency of the network.

Enabling KVM and/or media encryption will degrade performance. Enabling video compression provides the fastest response while disabling compression provides better video quality.

For the best possible KVM performance, a 2Mb/sec link or higher is recommended.

The redirection of KVM over IP is performed in parallel with the local KVM without affecting the local KVM operation.

4.2.2.3 Security

The KVM redirection feature supports multiple encryption algorithms, including RC4 and AES. The actual algorithm that is used is negotiated with the client based on the client's capabilities.

4.2.2.4 Availability

The remote KVM session is available even when the server is powered-off (in stand-by mode). No re-start of the remote KVM session shall be required during a server reset or power on/off. An Integrated BMC reset (e.g. due to an Integrated BMC Watchdog initiated reset or Integrated BMC reset after Integrated BMC firmware update) will require the session to be re-established.

KVM sessions persist across system reset, but not across an AC power loss.

4.2.2.5 Timeout

The remote KVM session will automatically timeout after a configurable amount of time (30 minutes is the default).

The default inactivity timeout is 30 minutes, but may be changed through the embedded web server. Remote KVM activation does not disable the local system keyboard, video, or mouse. Remote KVM is not deactivated by local system input, unless the feature is disabled locally.

4.2.2.6 Usage

As the server is powered up, the remote KVM session displays the complete BIOS boot process. The user is able interact with BIOS setup, change and save settings as well as enter and interact with option ROM configuration screens.

At least two concurrent remote KVM sessions are supported. It is possible for at least two different users to connect to same server and start remote KVM sessions

4.2.3 Media Redirection

The embedded web server provides a Java applet to enable remote media redirection. This may be used in conjunction with the remote KVM feature, or as a standalone applet.

The media redirection feature is intended to allow system administrators or users to mount a remote IDE or USB CD-ROM, floppy drive, or a USB flash disk as a remote device to the server. Once mounted, the remote device appears just like a local device to the server, allowing system administrators or users to install software (including operating systems), copy files, update BIOS, and so on, or boot the server from this device.

The following capabilities are supported:

- The operation of remotely mounted devices is independent of the local devices on the server. Both remote and local devices are useable in parallel.
- Either IDE (CD-ROM, floppy) or USB devices can be mounted as a remote device to the server.
- It is possible to boot all supported operating systems from the remotely mounted device and to boot from disk IMAGE (*.IMG) and CD-ROM or DVD-ROM ISO files. See the Tested/supported Operating System List for more information.
- Media redirection shall support redirection for a minimum of two virtual devices concurrently with any combination of devices. As an example, a user could redirect two CD or two USB devices.
- The media redirection feature supports multiple encryption algorithms, including RC4 and AES. The actual algorithm that is used is negotiated with the client based on the client's capabilities.
- A remote media session is maintained even when the server is powered-off (in standby mode). No restart of the remote media session is required during a server reset or power on/off. An Integrated BMC reset (e.g. due to an Integrated BMC reset after Integrated BMC firmware update) will require the session to be re-established
- The mounted device is visible to (and useable by) managed system's OS and BIOS in both pre-boot and post-boot states.
- The mounted device shows up in the BIOS boot order and it is possible to change the BIOS boot order to boot from this remote device.
- It is possible to install an operating system on a bare metal server (no OS present) using the remotely mounted device. This may also require the use of KVM-r to configure the OS during install.
- USB storage devices will appear as floppy disks over media redirection. This allows for the installation of device drivers during OS installation.
- If either a virtual IDE or virtual floppy device is remotely attached during system boot, both the virtual IDE and virtual floppy are presented as bootable devices. It is not possible to present only a single-mounted device type to the system BIOS.

4.2.3.1 Availability

The default inactivity timeout is 30 minutes and is not user-configurable.

Media redirection sessions persist across system reset but not across an AC power loss or BMC reset.

4.2.3.2 Network Port Usage

The KVM and media redirection features use the following ports:

- 5120 – CD Redirection
- 5123 – FD Redirection
- 5124 – CD Redirection (Secure)
- 5127 – FD Redirection (Secure)
- 7578 – Video Redirection
- 7582 – Video Redirection (Secure)

4.2.4 Embedded Web server

Integrated BMC Base manageability provides an embedded web server and an OEM-customizable web GUI which exposes the manageability features of the Integrated BMC base feature set. It is supported over all on-board NICs that have management connectivity to the Integrated BMC as well as an optional dedicated add-in management NIC. At least two concurrent web sessions from up to two different users is supported. The embedded web user interface shall support the following client web browsers:

- Microsoft* Internet Explorer 7.0
- Microsoft* Internet Explorer 8.0
- Microsoft* Internet Explorer 9.0
- Mozilla* Firefox 3.0
- Mozilla* Firefox 3.5
- Mozilla* Firefox 3.6

The embedded web user interface supports strong security (authentication, encryption, and firewall support) since it enables remote server configuration and control. The user interface presented by the embedded web user interface shall authenticate the user before allowing a web session to be initiated. Encryption using 128-bit SSL is supported. User authentication is based on user id and password.

The GUI presented by the embedded web server authenticates the user before allowing a web session to be initiated. It presents all functions to all users but grays-out those functions that the user does not have privilege to execute. (e.g. if a user does not have privilege to power control, then the item shall be displayed in grey-out font in that user's UI display). The web GUI also provides a launch point for some of the advanced features, such as KVM and media redirection.

These features are grayed out in the GUI unless the system has been updated to support these advanced features.

A partial list of additional features supported by the web GUI includes:

- Presents all the Basic features to the users.
- Power on/off/reset the server and view current power state.
- Virtual front panel display and overall system health.
- Provides embedded firmware version information.
- Configuration of various IPMI parameters (LAN parameters, users, passwords, etc.)
- Configuration of alerting (SNMP and SMTP).
- Display system asset information for the product, board, and chassis.
- Display of BMC-owned sensors (name, status, current reading, enabled thresholds), including color-code status of sensors.
- Automatic refresh of sensor data with a configurable refresh rate.
- On-line help.
- Display/clear SEL (display is in easily understandable human readable format).
- Supports major industry-standard browsers (Internet Explorer and Mozilla Firefox).
- Automatically logs out after user-configurable inactivity period.
- The GUI session automatically times-out after a user-configurable inactivity period. By default, this inactivity period is 30 minutes.
- Embedded Platform Debug feature - Allow the user to initiate a “diagnostic dump” to a file that can be sent to Intel® for debug purposes.
- Display of power statistics (current, average, minimum, and maximum) consumed by the server.

4.2.5 Embedded Platform Debug

The Embedded Platform Debug feature supports capturing low-level diagnostic data (applicable MSRs, PCI config-space registers, etc.). This feature allows a user to export this data into a file that is retrievable via the embedded web GUI, as well as through host and remote IPMI methods, for the purpose of sending to an Intel® engineer for an enhanced debugging capability. The files are compressed, encrypted, and password protected. The file is not meant to be viewable by the end user but rather to provide additional debugging capability to an Intel® support engineer.

A list of data that may be captured using this feature includes but is not limited to:

1. **Platform sensor readings** – This includes all “readable” sensors that can be accessed by the Integrated BMC firmware and have associated SDRs populated in the SDR repository. This does not include any “event-only” sensors. (All BIOS sensors and some Integrated BMC and ME sensors are “event-only”; meaning that they are not readable using an IPMI Get Sensor Reading command but rather are used just for event logging purposes).
2. **SEL** – The current SEL contents are saved in both hexadecimal and text format.
3. **CPU/memory register data useful for diagnosing the cause of the following system errors: CATERR, ERR[2], SMI timeout, PERR, and SERR.** The debug data is saved and timestamped for the last 3 occurrences of the error conditions.
 - a. PCI error registers
 - b. MSR registers
 - c. MCH registers
4. **Integrated BMC configuration data**
5. **Integrated BMC firmware debug log** (a.k.a. SysLog) – Captures firmware debug messages.

4.2.6 Data Center Management Interface (DCMI)

DCMI is an IPMI-based standard that builds upon a set of required IPMI standard commands by adding a set of DCMI-specific IPMI OEM commands. BTP1200-LC platform will support DCMI 1.0 specification.

4.2.7 Local Directory Authentication Protocol (LDAP)

The Lightweight Directory Access Protocol (LDAP) is an application protocol supported by the Integrated BMC for the purpose of authentication and authorization. The Integrated BMC user connects with an LDAP server for login authentication. This is only supported for non-IPMI logins including the embedded web UI and SM-CLP. IPMI users/passwords and sessions are not supported over LDAP.

LDAP can be configured (IP address of LDAP server, port, etc.) via the Integrated BMC's Embedded Web UI. LDAP authentication and authorization is supported over the any NIC configured for system management. The BMC uses a standard Open LDAP implementation for Linux.

4.3 Thermal Control

4.3.1 Memory Thermal Throttling

The system shall support thermal management through open loop throttling (OLTT) or static closed loop throttling (CLTT) of system memory based on availability of valid temperature sensors on the installed memory DIMMs. The Integrated Memory Controller (IMC) dynamically changes throttling levels to cap throttling based on memory and system thermal conditions as determined by the system and DIMM power and thermal parameters. Support for CLTT on

mixed-mode DIMM populations (i.e. some installed DIMMs have valid temp sensors and some do not) is not supported. The Integrated BMC fan speed control functionality is related to the memory throttling mechanism used.

The following terminology is used for the various memory throttling options:

- **Static Open Loop Thermal Throttling (Static-OLTT):** OLTT control registers are configured by BIOS MRC remain fixed after post. The system does not change any of the throttling control registers in the embedded memory controller during runtime.
- **Static Closed Loop Thermal Throttling (Static-CLTT):** CLTT control registers are configured by BIOS MRC during POST. The memory throttling is run as a closed-loop system with the DIMM temperature sensors as the control input. Otherwise, the system does not change any of the throttling control registers in the embedded memory controller during runtime.

4.3.2 Fan Speed Control

BIOS and BMC software work cooperatively to implement system thermal management support. During normal system operation, the BMC will retrieve information from the BIOS and monitor several platform thermal sensors to determine the required fan speeds.

In order to provide the proper fan speed control for a given system configuration, the BMC must have the appropriate platform data programmed. Platform configuration data is programmed using the FRUSDR utility during the system integration process and by System BIOS during run time.

4.3.2.1 System Configuration Using the FRUSDR Utility

The Field Replaceable Unit and Sensor Data Record Update Utility (FRUSDR utility) is a program used to write platform-specific configuration data to NVRAM on the server board. It allows the user to select which supported chassis (Intel® or Non-Intel) and platform chassis configuration is used. Based on the input provided, the FRUSDR writes sensor data specific to the configuration to NVRAM for the BMC controller to read each time the system is powered on.

4.4 Intel® Intelligent Power Node Manager

4.4.1 Overview

Power management deals with requirements to manage processor power consumption and manage power at the platform level to meet critical business needs. Node Manager (NM) is a platform resident technology that enforces power capping and thermal-triggered power capping policies for the platform. These policies are applied by exploiting subsystem knobs (such as processor P and T states) that can be used to control power consumption. NM enables data center power management by exposing an external interface to management software through which platform policies can be specified. It also implements specific data center power management usage models such as power limiting, and thermal monitoring.

The NM feature is implemented by a complementary architecture utilizing the ME, Integrated BMC, BIOS, and an ACPI-compliant OS. The ME provides the NM policy engine and power control/limiting functions (referred to as Node Manager or NM) while the Integrated BMC provides the external LAN link by which external management software can interact with the

feature. The BIOS provides system power information utilized by the NM algorithms and also exports ASL code used by OSPM for negotiating processor P and T state changes for power limiting. PMBus-compliant power supplies provide the capability to monitoring input power consumption, which is necessary to support NM.

The NM architecture applicable to this generation of servers is defined by the NPTM Architecture Specification v2.0. NPTM is an evolving technology that is expected to continue to add new capabilities that will be defined in subsequent versions of the specification. The ME NM implements the NPTM policy engine and control/monitoring algorithms defined in the NPTM specification.

4.4.2 Features

NM provides feature support for policy management, monitoring and querying, alerts and notifications, and an external interface protocol. The policy management features implement specific IT goals that can be specified as policy directives for NM. Monitoring and querying features enable tracking of power consumption. Alerts and notifications provide the foundation for automation of power management in the data center management stack. The external interface specifies the protocols that must be supported in this version of NM.

The table below summarizes the feature support for NM 2.0.

Table 12. NM Features

Task	Capabilities & Features	2.0
Monitor Power & Thermal	Platform power monitoring	✓
	Thermal monitoring and thermal policy support	
	Processor package power monitoring	✓
	Memory power monitoring	
Control Power Utilization	Power limiting policy support	Platform
	Processor power limiting	✓
	Memory power limiting	
	Dynamic core allocation (runtime core-idling)	
	Configure core power off at boot time	
	Configure power-optimized boot at boot time	
Delegate Power and Thermal Policy	Concurrent policies	✓
	Limit power upon power excursion (OS operational)	✓
	Reduce power upon temperature excursion	
	Limit power even when OS is not operational (OS failure)	✓

Task	Capabilities & Features	2.0
Avoid Triggering HW Protection	Reduce power consumption to prevent tripping DC circuit breaker	✓
	Power supply optimization technologies (SmaRT & CLST) used to limit power consumption to reduce demand on power supplies in specific scenarios.	
Interfaces	IPMI-based commands over SMBus (monitoring, control & alert)	✓
	PECI Proxy and Pass-Through (this feature is also available on the ME Si-Enabling firmware)	✓
	Power telemetry from Integrated BMC or from PMBus-compliant power supplies Note: EPSD systems have ME get power data directly from power supplies	✓

4.4.3 Role of Integrated BMC in NM

This section summarizes the Integrated BMC role in the NM feature implementation.

4.4.3.1 External Communications Link

The Integrated BMC provides the access point for remote commands from external management software and generates alerts to that software. The ME plays the role of an IPMI satellite controller that communicates to the Integrated BMC over a secondary IPMB. There are mechanisms to forward commands to ME and send response back to originator. Similarly events generated by ME to the Integrated BMC (via IPMB) have to be sent by the Integrated BMC to the external software over the LAN link. It is the responsibility of Integrated BMC to implement these mechanisms for communication with Node Manager (NM).

4.4.3.1.1 Command Passing Via Integrated BMC

External software wishing to communicate with the NM will send 'bridged' IPMI commands to Integrated BMC. This will be in the form an IPMI packet encapsulated in another packet, following standard IPMI bridging as described in the *IPMI 2.0 Specification*. Integrated BMC forwards the encapsulated command it to NM engine on the ME and returns the response to the sender.

Due to the fact that some of the NM commands have potential for performance limiting and system shut-down, the Integrated BMC firmware enforce an administrator privilege for any commands bridged to the ME.

4.4.3.1.2 Alerting

Alerts may be sent from the NM in the ME to the external software by one of two different methods depending on the nature of the alert.

Alerts that signify fault conditions that should be recorded in the system SEL will be sent to the Integrated BMC by the ME using the IPMI Platform Event Message command. The Integrated BMC deposits such events into the SEL. The external software must configure the Integrated BMC's PEF and alerting features to then send that event out as an IPMI LAN alert, directed to the software application over the LAN link.

Alerts that provide useful notification to the external software for NM management, but do not represent significant fault conditions that need to be put into the SEL, will be sent to the Integrated BMC using the IPMI Alert Immediate command. This requires that the external software application provide the NM on the ME with the alert destination and alert string information needed to properly form and send the alert. The external software must first properly configure the alert destination and string in the Integrated BMC LAN configuration using standard IPMI commands, then provide the associated selectors to the Integrated BMC using the “Set Node Manager Alert Destination” OEM command.

4.4.3.2 BIOS-Integrated BMC-ME Communication

In this generation of platforms, the BIOS communicates directly with the ME via HECI.

5. Server Management Capability for Intel® Server Board S1200BTS

5.1 Supper I/O

5.1.1 Key Features of supper I/O

The W83627DHG-P is from the Nuvoton's Super I/O product line. This family features the LPC (Low Pin Count) interface. This interface is more economical than its ISA counterpart. It has approximately forty pins less, yet it provides as great performance. In addition, the improvement allows even more efficient operation of software, BIOS, and device drivers.

The W83627DHG-P provides the following key features:

- Meet LPC Spec. 1.01
- Integrated hardware monitor functions
- Support ACPI (Advanced Configuration and Power Interface)
- Support up to 2 16550-compatible UARTs ports
- 8042-based keyboard controller
- Smart Fan control system
- Five fan-speed monitoring inputs
- Four fan-speed controls
- GPIO
- Support PECI 1.0 and 1.1a Specifications

6. BIOS User Interface

6.1 BIOS POST Initialization

6.1.1 BIOS Revision Identification

6.1.1.1 BIOS ID String

The BIOS Identification string is used to uniquely identify the revision of the BIOS being used on the server. The BIOS ID string is displayed on the Power On Self Test (POST) diagnostic screen and in Setup and System Management BIOS (SMBIOS) structures.

The BIOS ID string is formatted as follows:

6.1.1.2 BoardFamilyID.OEMID.MajorVer.RelRev.RelNum.BuildDateTime

Where:

- **BoardFamilyID** = String name for to identify board family.
 - “**S1200BT**” is used to identify BIOS builds for S1200BT server boards.
- **OEMID** = Three-character OEM BIOS Identifier, to identify the board BIOS “owner”. Changed only if and when BIOS Development management authorizes a BIOS program for a specific OEM customer.
 - “**86B**” is used for BIOS Releases.
- **MajorVer** = Major Version, two decimal digits 01-99 which are changed only to identify major hardware or functionality changes that affect BIOS compatibility between boards.
 - “**01**” is the starting BIOS Major Version for all platforms. This designation can change only at the discretion of BIOS Development management.
- **RelRev** = Release Revision, two decimal digits 00-99 which are changed to identify specific "point releases" or branches based on a given BIOS Release but with targeted minor fixes or special-purpose differences in functionality from the primary BIOS Release. The Release Revision first digit is incremented for each initial revision of a BIOS Release. The second digit will increment only if a revision itself needs to be revised with a change or fix. The Release Number will not change when a BIOS is built as a Release Revision and will reset to “00” with each new Release Number.
 - “**00**” is the starting Release Revision for all platform BIOS Releases. Release Revisions are not Standard Operating Procedure, but may be produced if authorized BIOS management.

The sequence will be as in the following examples for Release Revision and Release Number:

- Release 2 (i.e., 2.0) = RelRev/RelNum “.00.0002”
- Release 2 Revision 1(i.e., 2.1) = RelRev/RelNum “.10.0002”
- Release 2 Revision 1 fix 1 (i.e., 2.11) = RelRev/RelNum “.11.0002”
- Release 3 (i.e., 3.0) = reverts to RelRev/RelNum “.00.0003”

- **RelNum** = Release Number, four decimal digits which are changed to identify distinct BIOS Releases. BIOS Releases are major collections of fixes and changes in functionality.
 - “0001” is the starting Release Number for all platform BIOS releases, for each distinct BoardFamilyID and OEMID. This number increases by 1 for each BIOS release. It does not increment for a Release Revision. It resets to 0001 when the Major Version changes, or for a different BoardFamilyID or OEMID.
- **BuildDateTime** = Build timestamp – date and time in MMDDYYYYHHMM format:
 - MM = Two-digit month.
 - DD = Two-digit day of month.
 - YYYY = Four-digit year.
 - HH = Two-digit hour using 24-hour clock.
 - MM = Two-digit minute.

For example, the following BIOS ID string is displayed on the POST diagnostic screen for BIOS Release 3 that is generated on August 13, 2010 at 11:56 AM:

S1200BT.86B.01.00.0003.081320101156

The BIOS version in the Setup Utility is displayed without the time/date timestamp, which is displayed separately as “Build Date”:

S1200BT.86B.01.00.0003

For the SMBIOS Type 0 BIOS Version field, the full BIOS ID string is used, including the complete timestamp.

6.1.1.3 OEM BIOS Differentiation Support

There is an optional “OEM Extension” segment which can be added by an OEM customer to distinguish an OEM-specific edited version of the BIOS from a standard Intel® version. This “OEM Extension” will never be present in a standard BIOS supplied directly by Intel®. This can only be done using a restricted-distribution BIOS utility available through Technical Marketing OEM support channels.

6.2 HotKeys Supported During POST

Certain “HotKeys” are recognized during POST. A HotKey is a key or key combination that is recognized as an unprompted command input, that is, the operator is not prompted to press the HotKey and typically the HotKey will be recognized even while other processing is in progress.

The Server Board BIOS recognizes a number of HotKeys during POST. After the OS is booted, HotKeys are the responsibility of the OS and the OS defines its own set of recognized HotKeys.

Following are the POST HotKeys, with the functions they cause to be performed.

Table 13. POST HotKeys Recognized

HotKey Combination	Function
<F2>	Enter Setup
<F6>	Pop up BIOS Boot Menu
<F12>	Network boot

6.3 POST Logo Screen/Diagnostic Screen

The Logo Screen/Diagnostic Screen appears in one of two forms:

- If Quiet Boot is enabled in the BIOS setup, a “splash screen” is displayed with a logo image, which is the standard Intel® Logo Screen or a customized OEM Logo Screen. By default, Quiet Boot is enabled in the BIOS setup, so the Logo Screen will be the default POST display. However, if the logo is displayed during POST, the user can press <Esc> to hide the logo and display the Diagnostic Screen instead.
- If a logo is not present in the BIOS Flash Memory space, or if Quiet Boot is disabled in the system configuration, the POST Diagnostic Screen is displayed with a summary of system configuration information.

The diagnostic screen displays the following information:

- “Copyright <year> Intel Corporation”
- AMI Copyright statement
- BIOS version (ID).
- BMC firmware version.
- SDR version.
- ME firmware version.
- Platform ID (identifies the board on which the BIOS is running).
- System memory detected (total size of all installed DDR3 DIMMs).
- Current memory speed (currently configured memory operating frequency)
- Processor information (Intel® Brand String identifying type of processor and nominal operating frequency, and number of physical processors identified).
- Keyboards detected, if any attached.
- Mouse devices detected, if any attached.
- Instructions showing hotkeys for going to Setup, going to popup Boot Menu, starting Network Boot

6.4 BIOS Boot Pop-up Menu

The BIOS Boot Specification (BBS) provides a Boot Pop-up menu that can be invoked by pressing the <F6> key during POST. The BBS Pop-up menu displays all available boot devices. The boot order in the pop-up menu is not the same as the boot order in the BIOS setup. The pop-up menu simply lists all of the available devices from which the system can be booted, and allows a manual selection of the desired boot device.

When an Administrator password is installed in Setup, the Administrator password will be required in order to access the Boot Pop-up menu using the <F6> key. If a User password is entered, the Boot Pop-up menu will not even appear – the user will be taken directly to the Boot Manager in the Setup, where a User password allows only booting in the order previously defined by the Administrator.

6.5 BIOS Setup Utility

The BIOS Setup utility is a text-based utility that allows the user to configure the system and view current settings and environment information for the platform devices. The Setup utility controls the platform's built-in devices, the boot manager, and error manager.

The BIOS Setup interface consists of a number of pages or screens. Each page contains information or links to other pages. The advanced tab in Setup displays a list of general categories as links. These links lead to pages containing a specific category's configuration.

The following sections describe the look and behavior for the platform setup.

6.5.1 BIOS Setup Operation

The BIOS Setup Utility has the following features:

- Localization – The Intel® Server Board BIOS is only available in English. However, BIOS Setup uses the Unicode standard and is capable of displaying data and input in Setup fields in all languages currently included in the Unicode standard.
- Console Redirection – BIOS Setup is functional via Console Redirection over various terminal emulation standards.
- Setup screens are designed to be displayable in an 80-character x 24-line format in order to work with Console Redirection, although that screen layout should display correctly on any format with longer lines or more lines on the screen.
- Password protection – BIOS Setup may be protected from unauthorized changes by setting an Administrative Password in the Security screen. When an Administrative Password has been set, all selection and data entry fields in Setup (except System Time and Date) are grayed out and cannot be changed unless the Administrative Password has been entered.

Note: If an Administrative Password has not been set, anyone who boots the system to Setup has access to all selection and data entry fields in Setup and can change any of them.

6.5.1.1 Setup Page Layout

The Setup page layout is sectioned into functional areas. Each occupies a specific area of the screen and has dedicated functionality. The following table lists and describes each functional area.

The Setup page is designed to a format of 80 x 24 (24 lines of 80 characters each). The typical display screen in a Legacy mode or in a terminal emulator mode is actually 80 characters by 25 lines, but with “line wrap” enabled (which it usually is) the 25th line cannot be used with the Setup page.

Table 14. BIOS Setup Page Layout

Functional Area	Description
Title Bar	The title bar is located at the top of the screen and displays the title of the form (page) the user is currently viewing. It may also display navigational information.
Setup Item List	The Setup Item List is a set of control entries and informational items. The list is displayed in two columns. For each item in the list, a prompt string (or label string) occupies the left column of the list, and the right column contains either a data display, a data input field, or a multiple choice field. The operator navigates up and down the right hand column through the available input or choice fields. A Setup Item may also represent a selection to open a new screen with a further group of options for specific functionality. In this case, the operator navigates to the desired selection and presses <Enter> to go to the new screen.
Item-Specific Help Area	The Item-specific Help area is located on the right side of the screen and contains help text for the highlighted Setup Item. Help information may include the meaning and usage of the item, allowable values, effects of the options, etc.
Keyboard Command Bar	The Keyboard Command Bar is located at the bottom right of the screen and continuously displays help for keyboard special keys and navigation keys.

6.5.1.2 Entering BIOS Setup

To enter the BIOS Setup using a keyboard (or emulated keyboard); press the <F2> function key during boot time when the OEM or Intel® logo is displayed. The following message is displayed on the diagnostics screen and under the Quiet Boot logo screen:

Press <F2> to enter setup

When the Setup Utility is entered, the Main screen is displayed. However, serious errors cause the system to display the Error Manager screen instead of the Main screen.

6.5.1.3 Setup Navigation Keyboard Commands

The bottom right portion of the Setup screen provides a list of commands that are used to navigate through the Setup utility. These commands are displayed at all times.

Each Setup menu page contains a number of features. Each feature is associated with a value field, except those used for informative purposes. Each value field contains configurable parameters. Depending on the security option chosen and in effect by the password, a menu feature's value may or may not be changed. If a value cannot be changed, its field is made inaccessible and appears grayed out.

Table 15. BIOS Setup: Keyboard Command Bar

Key	Option	Description
<Enter>	Execute Command	The <Enter> key is used to activate submenus when the selected feature is a submenu, or to display a pick list if a selected option has a value field, or to select a subfield for multi-valued features like time and date. If a pick list is displayed, the <Enter> key selects the currently highlighted item, undoes the pick list, and returns the focus to the parent menu.
<Esc>	Exit	The <Esc> key provides a mechanism for backing out of any field. When the <Esc> key is pressed while editing any field or selecting features of a menu, the parent menu is re-entered. When the <Esc> key is pressed in any submenu, the parent menu is re-entered. When the <Esc> key is pressed in any major menu, the exit confirmation window is displayed and the user is asked whether changes can be discarded. If “No” is selected and the <Enter> key is pressed, or if the <Esc> key is pressed, the user is returned to where they were before <Esc> was pressed, without affecting any existing settings. If “Yes” is selected and the <Enter> key is pressed, the setup is exited and the BIOS returns to the main System Options Menu screen.
↑	Select Item	The up arrow is used to select the previous value in a pick list, or the previous option in a menu item’s option list. The selected item must then be activated by pressing the <Enter> key.
	Select Item	The down arrow is used to select the next value in a menu item’s option list, or a value field’s pick list. The selected item must then be activated by pressing the <Enter> key.
	Select Menu	The left and right arrow keys are used to move between the major menu pages. The keys have no effect if a sub-menu or pick list is displayed.
<Tab>	Select Field	The <Tab> key is used to move between fields. For example, <Tab> can be used to move from hours to minutes in the time item in the main menu.
-	Change Value	The minus key on the keypad is used to change the value of the current item to the previous value. This key scrolls through the values in the associated pick list without displaying the full list.
+	Change Value	The plus key on the keypad is used to change the value of the current menu item to the next value. This key scrolls through the values in the associated pick list without displaying the full list. On 106-key Japanese keyboards, the plus key has a different scan code than the plus key on the other keyboards, but will have the same effect.
<F9>	Setup Defaults	Pressing the <F9> key causes the following to display: <div style="border: 1px solid black; padding: 5px; margin: 10px 0;">Load Optimized Defaults? Yes No</div> If “Yes” is highlighted and <Enter> is pressed, all Setup fields are set to their default values. If “No” is highlighted and <Enter> is pressed, or if the <Esc> key is pressed, the user is returned to where they were before <F9> was pressed without affecting any existing field values.
<F10>	Save and Exit	Pressing the <F10> key causes the following message to display: <div style="border: 1px solid black; padding: 5px; margin: 10px 0;">Save configuration and reset? Yes No</div> If “Yes” is highlighted and <Enter> is pressed, all changes are saved and the Setup is exited. If “No” is highlighted and <Enter> is pressed, or the <Esc> key is pressed, the user is returned to where they were before <F10> was pressed without affecting any existing values.

6.5.1.4 Setup Screen Menu Selection Bar

The Setup Screen Menu selection bar is located at the top of the BIOS Setup Utility screen. It displays tabs showing the major screen selections available to the user. By using the left and right arrow keys, the user can select the listed screens. Some screen selections are out of the visible menu space, and become available by scrolling to the left or right of the current selections displayed.

6.5.2 BIOS Setup Utility Screens

The following sections describe the screens available in the BIOS Setup utility for the configuration of the server platform.

For each of these screens, there is an image of the screen with a list of Field Descriptions which describe the contents of each item on the screen. Each item on the screen is hyperlinked to the relevant Field Description. Each Field Description is hyperlinked back to the screen image.

These lists follow the following guidelines:

- The text heading for each Field Description is the actual text as displayed on the BIOS Setup screen. This screen text is a hyperlink to it's corresponding Field Description.
- The text shown in the Option Values and Help Text entries in each Field Description are the actual text and values are displayed on the BIOS Setup screens.
- In the Option Values entries, the text for default values is shown with an underline. These values do not appear underline on the BIOS Setup screen. The underlined text in this document is to serve as a reference to which value is the default value.
- The Help Text entry is the actual text which appears on the screen to accompany the item when the item is the one in focus (active on the screen).
- The Comments entry provides additional information where it may be helpful. This information does not appear on the BIOS Setup screens.
- Information enclosed in angular brackets (< >) in the screen shots identifies text that can vary, depending on the option(s) installed. For example, <Amount of memory installed> is replaced by the actual value for "Total Memory".
- Information enclosed in square brackets ([]) in the tables identifies areas where the user must type in text instead of selecting from a provided option.
- Whenever information is changed (except Date and Time), the systems requires a save and reboot to take place in order for the changes to take effect. Alternatively, pressing <ESC> discards the changes and resumes POST to continue to boot the system according to the boot order set from the last boot.

6.5.2.1 Map of Screens and Functionality

There are a number of screens in the entire Setup collection. They are organized into major categories. Each category has a hierarchy beginning with a top-level screen from which lower-

level screens may be selected. Each top-level screen appears as a tab, arranged across the top of the Setup screen image of all top-level screens.

There are more categories than will fit across the top of the screen, so at any given time there will be some categories which will not appear until the user has scrolled across the tabs which are present.

The categories and the screens included in each category are listed below, with links to each of the screens named.

Table 16. Screen Map

Categories (Top Tabs)	2nd Level Screens	3rd Level Screens
Main Screen (Tab)	—	—
Advanced Screen (Tab)	—	—
↵	Processor Configuration	—
↵	Memory Configuration	—
↵	Mass Storage Controller Configuration	—
↵	Serial Port Configuration	—
↵	USB Configuration	—
↵	PCI Configuration	—
↵	System Acoustic and Performance Configuration	—

Categories (Top Tabs)	2nd Level Screens	3rd Level Screens
Security Screen (Tab)	—	—
Server Management Screen (Tab)	—	—
↳	Console Redirection	—
↳	System Information	—
↳ [With BMC Only]	BMC LAN Configuration	—
↳ [Non-BMC Only]	Hardware Monitor	—
—	↳ [Non-BMC Only]	Realtime Temperature and Voltage Status
Boot Options Screen (Tab)		—
↳	Hard Disk Order	—
↳	CDROM Order	—
↳	Floppy Order	—
↳	Network Device Order	—
↳	BEV Device Order	—
↳	Add EFI Boot Option	—
↳	Delete EFI Boot Option	—
Boot Manager Screen (Tab)	—	—
Error Manager Screen (Tab)	—	—
System Event Log Screen (Tab) [Non-BMC Only]	—	—
Exit Screen (Tab)	—	—

6.5.2.2 Main Screen (Tab)

The Main Screen is the first screen that appears when the BIOS Setup configuration utility is entered, unless an error has occurred. If an error has occurred, the Error Manager Screen appears instead.

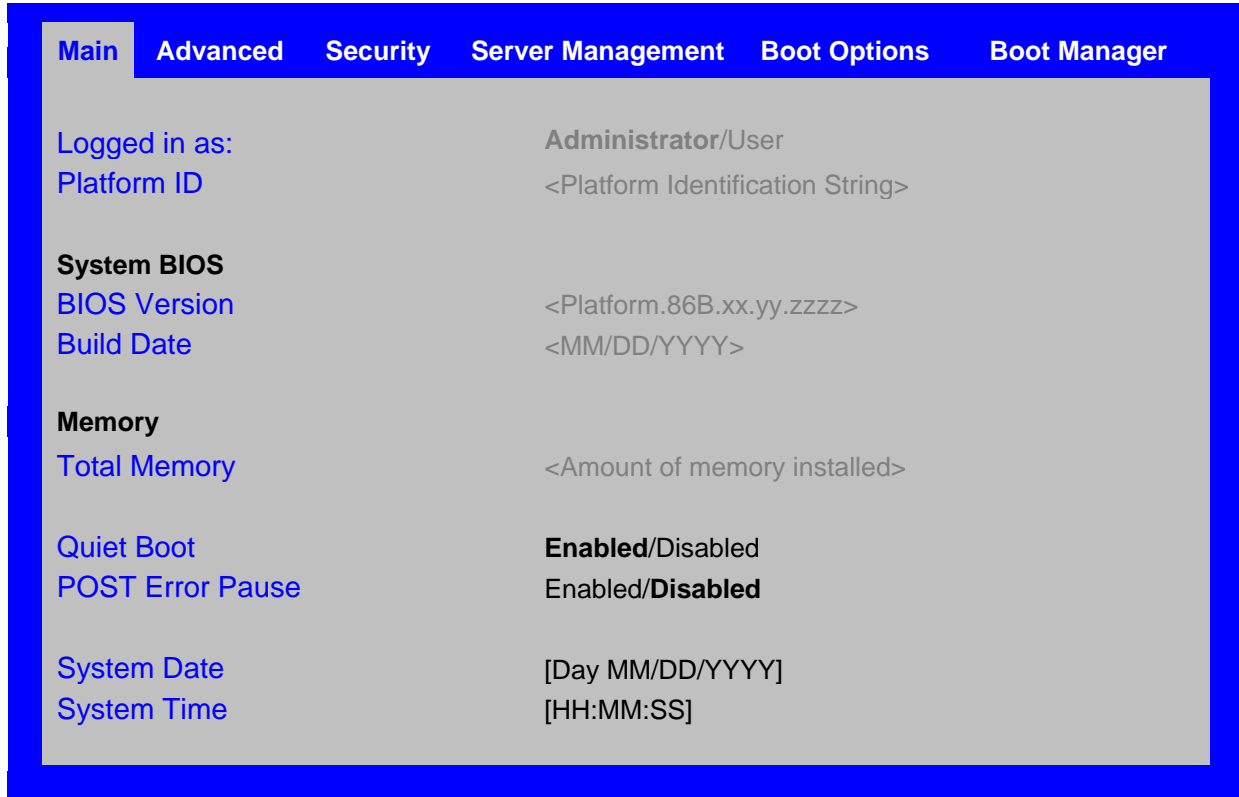

Figure 15. Main Screen

Screen Field Descriptions:

1. Logged in as:

Option Values: <Administrator / User>

Help Text: <None>

Comments: Information only. Displays password level that setup is running in: Administrator or User. With no passwords set, Administrator is the default mode.

2. Platform ID

Option Values: < Platform ID>

Help Text: <None>

Comments: Information only. Displays the Platform ID for the board on which the BIOS is executing POST.

3. BIOS Version

Option Values: <Current BIOS version ID>

Help Text: <None>

Comments: Information only. The version information displayed is taken from the BIOS ID String, with the timestamp segment dropped off. The segments displayed are:

Platform:	Identifies whether this is a platform BIOS
86B:	Identifies this BIOS as being an EPSD Server BIOS
xx:	Major Revision level of the BIOS
yy:	Release Revision level for this BIOS
zzzz:	Release Number for this BIOS

4. Build Date

Option Values: <Date and time when the currently installed BIOS was created (built)>

Help Text: <None>

Comments: Information only. The time and date displayed are taken from the timestamp segment of the BIOS ID String.

5. Total Memory

Option Values: <Amount of memory installed in the system>

Help Text: <None>

Comments: Information only. Displays the total physical memory installed in the system, in MB or GB. The term physical memory indicates the total memory discovered in the form of installed DDR3 DIMMs.

6. Quiet Boot

Option Values: **Enabled**
Disabled

Help Text:

[Enabled] – Display the logo screen during POST.
[Disabled] – Display the diagnostic screen during POST.

7. POST Error Pause

Option Values: Enabled
 Disabled

Help Text:

[Enabled] – Go to the Error Manager for critical POST errors.

[Disabled] – Attempt to boot and do not go to the Error Manager for critical POST errors.

Comments: If enabled, the POST Error Pause option takes the system to the error manager to review the errors when major errors occur. Minor and fatal error displays are not affected by this setting.

8. System Date

Option Values: <System Date initially displays the current system calendar date, including the day of the week>

Help Text:

System Date has configurable fields for the current Month, Day, and Year.

The year must be between 2005 and 2099.

Use [Enter] or [Tab] key to select the next field.

Use [+] or [-] key to modify the selected field.

Comments: This field will initially display the current system day of week and date. It may be edited to change the system date.

9. System Time

Option Values: <System Time initially displays the current system time of day, in 24-hour format>

Help Text:

System Time has configurable fields for Hours, Minutes, and Seconds.

Hours are in 24-hour format.

Use the [Enter] or [Tab] key to select the next field.

Use the [+] or [-] key to modify the selected field.

Comments: This field will initially display the current system time (24 hour time). It may be edited to change the system time.

6.5.2.3 **Advanced Screen (Tab)**

The Advanced screen provides an access point to configure several groups of options. On this screen, the user can select the option group to be configured. Configuration actions are performed on the selected screen, and not directly on the **Advanced** screen.

To access this screen from the **Main** screen or other top-level “Tab” screen, press the right or left arrow keys to traverse the tabs at the top of the Setup screen until the **Advanced** screen is selected.

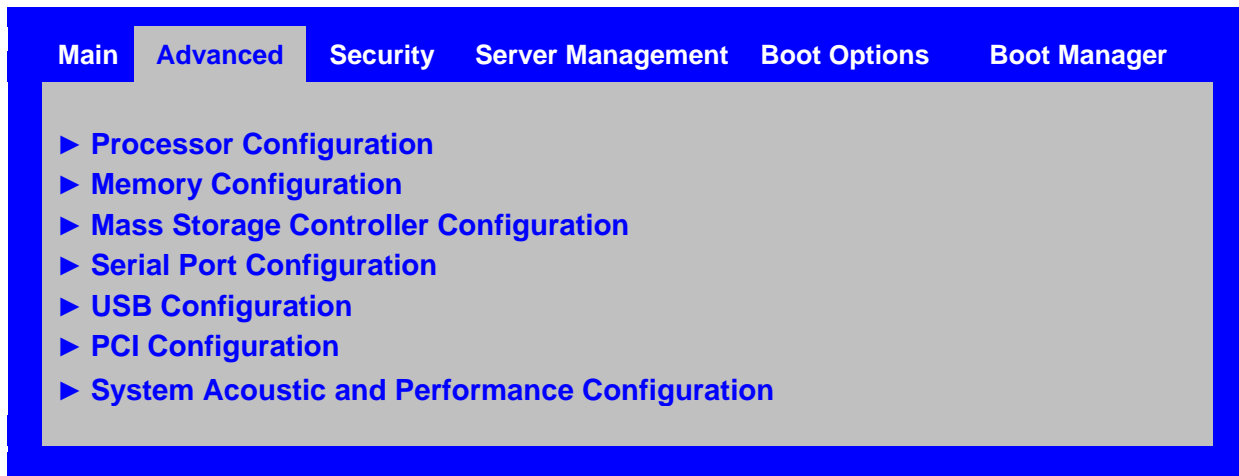

Figure 16. Advanced Screen

Screen Field Descriptions:

1. Processor Configuration

Option Values: <None>

Help Text: View/Configure processor information and settings.

Comments: Selection only. Position to this line and press the <Enter> key to go to the **Processor Configuration** group of configuration settings.

2. Memory Configuration

Option Values: <None>

Help Text:

View/Configure memory information and settings.

Comments: Selection only. Position to this line and press the <Enter> key to go to the **Memory Configuration** group of configuration settings.

3. Mass Storage Controller Configuration

Option Values: <None>

Help Text:

View/Configure mass storage controller information and settings.

Comments: Selection only. Position to this line and press the <Enter> key to go to the **Mass Storage Controller Configuration** group of configuration settings.

4. Serial Port Configuration

Option Values: <None>

Help Text:

View/Configure serial port information and settings.

Comments: Selection only. Position to this line and press the <Enter> key to go to the **Serial Port Configuration** group of configuration settings.

5. USB Configuration

Option Values: <None>

Help Text:

View/Configure USB information and settings.

Comments: Selection only. Position to this line and press the <Enter> key to go to the **USB Configuration** group of configuration settings.

6. PCI Configuration

Option Values: <None>

Help Text:

View/Configure PCI information and settings.

Comments: Selection only. Position to this line and press the <Enter> key to go to the **PCI Configuration** group of configuration settings.

7. System Acoustic and Performance Configuration

Option Values: <None>

Help Text:

View/Configure system acoustic and performance information and settings.

Comments: Selection only. Position to this line and press the <Enter> key to go to the **System Acoustic and Performance Configuration** group of configuration settings.

6.5.2.4 Processor Configuration

The Processor Configuration screen displays the processor identification and microcode level, core frequency, cache sizes, Intel® QuickPath Interconnect information for all processors currently installed. It also allows the user to enable or disable a number of processor options.

To access this screen from the **Main** screen, select **Advanced > Processor Configuration**. To move to another screen, press the <Esc> key to return to the **Advanced** screen, then select the desired screen.



Figure 17. Processor Configuration Screen

Screen Field Descriptions:**1. Processor ID**

Option Values: <CPUID>

Help Text: <None>

Comments: Information only. Displays the Processor Signature value (from the CPUID instruction) identifying the type of processor and the stepping Processor Frequency

Option Values: <Current Processor Operating Frequency>

Help Text: <None>

Comments: Information only. Displays current operating frequency of the processor.

2. Microcode Revision

Option Values: <Microcode Revision Number>

Help Text: <None>

Comments: Information only. Displays Revision Level of the currently loaded processor microcode.

3. L1 Cache RAM

Option Values: <L1 cache size>

Help Text: <None>

Comments: Information only. Displays size in KB of the processor L1 Cache. Since L1 cache is not shared between cores, this is shown as the amount of L1 cache per core. There are two types of L1 cache for the SandyBridge processor family, this amount is the total of L1 Instruction Cache plus L1Data Cache for each core.

4. L2 Cache RAM

Option Values: <L2 cache size>

Help Text: <None>

Comments: Information only. Displays size in KB of the processor L2 Cache. Since L2 cache is not shared between cores, this is shown as the amount of L2 cache per core.

5. L3 Cache RAM

Option Values: <L3 cache size>

Help Text: <None>

Comments: Information only. Displays size in MB of the processor L3 Cache. Since L3 cache is shared between all cores in a processor package, this is shown as the total amount of L3 cache per processor package. S1200BT boards have a single processor display. Romley boards have "N/A" for the second processor if not installed.

6. Processor Version

Option Values: <ID string from processor>

Help Text: <None>

Comments: Information only. Displays Brand ID string read from processor with CPUID instruction.

7. Intel® Turbo Boost Technology

Option Values: **Enabled**
Disabled

Help Text:

Intel® Turbo Boost Technology allows the processor to automatically increase its frequency if it is running below power, temperature, and current specifications.

Comments: This option is only visible if all processors installed in the system support Intel® Turbo Boost Technology. In order for this option to be available, Enhanced Intel® SpeedStep® Technology must be **Enabled**.

8. Enhanced Intel® SpeedStep® Tech

Option Values: **Enabled**
Disabled

Help Text:

Enhanced Intel® SpeedStep® Technology allows the system to dynamically adjust processor voltage and core frequency, which can result in decreased average power consumption and decreased average heat production.

Contact your OS vendor regarding OS support of this feature.

Comments: When Disabled, the processor setting reverts to running at Max TDP Core Frequency (rated frequency).

This option is only visible if all processors installed in the system support Enhanced Intel® SpeedStep® Technology. In order for the Intel® Turbo Boost option to be available, Enhanced Intel® SpeedStep® Technology must be **Enabled**.

9. Turbo Boost Performance/Watt Mode

Option Values: **Power Optimized**
Traditional

Help Text:

When Power Optimized is selected, Intel® Turbo Boost Technology engages after performance state P0 is sustained for more than 2 seconds. When Traditional is selected, Intel® Turbo Boost Technology is engaged even for P0 requests less than 2 seconds

Comments: Turbo Boost Power Optimization is not available on all processors, and is available only when Intel® Turbo Boost Technology and Enhanced Intel® SpeedStep® Technology are **Enabled**.

10. Processor C3

Option Values: Enabled
Disabled

Help Text:

Enable/Disable Processor C3 (ACPI C2/C3) report to OS

Comments: This is normally **Disabled**, but can be **Enabled** for improved performance on certain benchmarks and in certain situations.

11. Processor C6

Option Values: **Enabled**
 Disabled

Help Text:

Enable/Disable Processor C6 (ACPI C3) report to OS

Comments: This is normally **Enabled** but can be **Disabled** for improved performance on certain benchmarks and in certain situations.

12. Intel® Hyper-Threading Tech

Option Values: **Enabled**
 Disabled

Help Text:

Intel® Hyper-Threading Technology allows multithreaded software applications to execute threads in parallel within each processor.

Contact your OS vendor regarding OS support of this feature.

Comments: This option is only visible if all processors installed in the system support Intel® Hyper-Threading Technology.

13. Core Multi-Processing

Option Values: **All**
 2
 4

Help Text:

Enable 1, 2, 3, 4, 5, 6, 7 or all cores of installed processor packages.

Comments: The number of cores that appear as selections and in the Help text depends on the number of cores in the processors installed.

14. Execute Disable Bit

Option Values: **Enabled**
 Disabled

Help Text:

Execute Disable Bit can help prevent certain classes of malicious buffer overflow attacks.

Contact your OS vendor regarding OS support of this feature.

Comments: This option is only visible if all processors installed in the system support the Execute Disable Bit. The OS and applications installed must support this feature in order for it to be enabled.

15. Intel® Virtualization Technology

Option Values: Enabled
 Disabled

Help Text:

Intel® Virtualization Technology allows a platform to run multiple operating systems and applications in independent partitions.

Note: A change to this option requires the system to be powered off and then back on before the setting takes effect.

Comments: This option is only visible if all processors installed in the system support Intel® VT. The software configuration installed on the system must support this feature in order for it to be enabled.

16. Intel® VT for Directed I/O

Option Values: Enabled
Disabled

Help Text:

Enable/Disable Intel® Virtualization Technology for Directed I/O (Intel® VT-d).

Report the I/O device assignment to VMM through DMAR ACPI Tables.

Comments: This option is only visible if all processors installed in the system support Intel® VT-d. The software configuration installed on the system must support this feature in order for it to be enabled.

17. Interrupt Remapping

Option Values: **Enabled**
Disabled

Help Text:

Enable/Disable Intel® VT-d Interrupt Remapping support.

Comments: This option only appears when Intel® Virtualization Technology for Directed I/O is **Enabled**.

18. ATS Support

Option Values: Enabled
Disabled

Help Text:

Enable/Disable Intel® VT-d Address Translation Services (ATS) support.

Comments: This option only appears when Intel® Virtualization Technology for Directed I/O is Enabled. Appears only on Romley boards.

19. Pass-through DMA Support

Option Values: **Enabled**
Disabled

Help Text:

Enable/Disable Intel® VT-d Pass-through DMA support.

Comments: This option only appears when Intel® Virtualization Technology for Directed I/O is **Enabled**.

20. Hardware Prefetcher

Option Values: **Enabled**
Disabled

Help Text:

Hardware Prefetcher is a speculative prefetch unit within the processor(s).

Note: Modifying this setting may affect system performance.

Comments: System performance is usually best with Hardware Prefetcher **Enabled**. In certain unusual cases, disabling this may give improved results.

21. Adjacent Cache Line Prefetch

Option Values: **Enabled**
 Disabled

Help Text:

[Enabled] - Cache lines are fetched in pairs (even line + odd line).

[Disabled] - Only the current cache line required is fetched.

Note: Modifying this setting may affect system performance

Comments: System performance is usually best with Adjacent Cache Line Prefetch **Enabled**. In certain unusual cases, disabling this may give improved results.

6.5.2.5 Memory Configuration

The Memory Configuration screen allows the user to view details about the DDR3 DIMMs that are installed as system memory.

To access this screen from the Main screen, select **Advanced > Memory Configuration**. To move to another screen, press the **<Esc>** key to return to the **Advanced** screen, then select the desired screen.

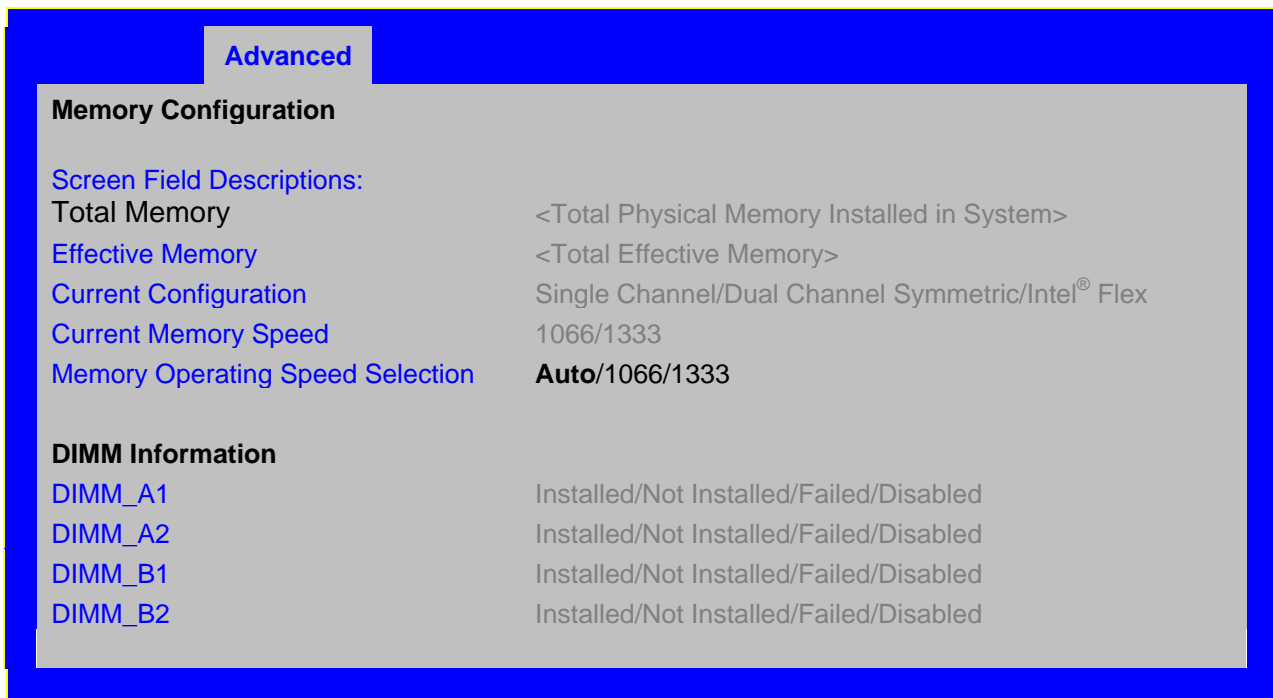

Figure 18. Memory Configuration Screen

Screen Field Descriptions:**1. Total Memory**

Option Values: <Total Physical Memory Installed in System>

Help Text: <None>

Comments: Information only. Displays the amount of memory available in the system in the form of installed DDR3 DIMMs, in units of GB.

2. Effective Memory

Option Values: <Total Effective Memory>

Help Text: <None>

Comments: Information only. Displays the amount of memory available to the OS in MB or GB.

The Effective Memory is the difference between Total Physical Memory and the sum of all memory reserved for internal usage, RAS redundancy and SMRAM. This difference includes the sum of all DDR3 DIMMs that failed Memory BIST during POST or were disabled by the BIOS during the memory discovery phase in order to optimize memory configuration.

Note: some server operating systems do not display the total physical memory installed.

3. Current Configuration

Option Values: Single Channel
Dual Channel Symmetric
Intel® Flex

Help Text: <None>

Comments: Displays one of the following:

- **Single Channel** – DIMMs are operating in Single Channel mode. This is the configuration when only one channel is populated with DIMMs.
- **Dual Channel Symmetric** – DIMMs are operating in Dual Channel Symmetric mode. This is the configuration when both channels are identically populated with DIMMs.
- **Intel® Flex** – DIMMs are configured according to Intel® Flex Memory Technology, where part of the memory is in Dual Channel Symmetric mode and part in Dual Channel Asymmetric mode. This is the configuration when both channels are populated, but with unequal amounts of memory.

4. Current Memory Speed

Option Values: 1066
1333

Help Text: <None>

Comments: Displays the speed in MT/s at which the memory is currently running.

5. Memory Operating Speed Selection

Option Values: **Auto**
1066
1333

Help Text: Force specific Memory Operating Speed or use Auto setting.

Comments: Displays the state of each DIMM socket present on the board. Each DIMM socket field reflects one of the following possible states:

6. DIMM_A1

7. DIMM_A2

8. DIMM_B1

9. DIMM_B2

Option Values: Installed
Not Installed
Failed
Disabled

Help Text: <None>

Comments: Information only, for S1200 boards: Displays the state of each DIMM socket present on the board. Each DIMM socket field reflects one of the following possible states:

- **Installed** – There is a DDR3 DIMM installed in this slot.
- **Not Installed** – There is no DDR3 DIMM installed in this slot.
- **Failed** – The DDR3 DIMM installed in this slot has been disabled by the BIOS in order to optimize the memory configuration.
- **Disabled** – The DDR3 DIMM installed in this slot is faulty or malfunctioning.

6.5.2.6 Mass Storage Controller Configuration

The Mass Storage Configuration screen allows the user to configure the SATA or SAS controller when it is present on the server board, midplane or backplane of an Intel® system.

To access this screen from the **Main** screen, select **Advanced > Mass Storage Controller Configuration**. To move to another screen, press the **<Esc>** key to return to the **Advanced** screen, then select the desired screen.

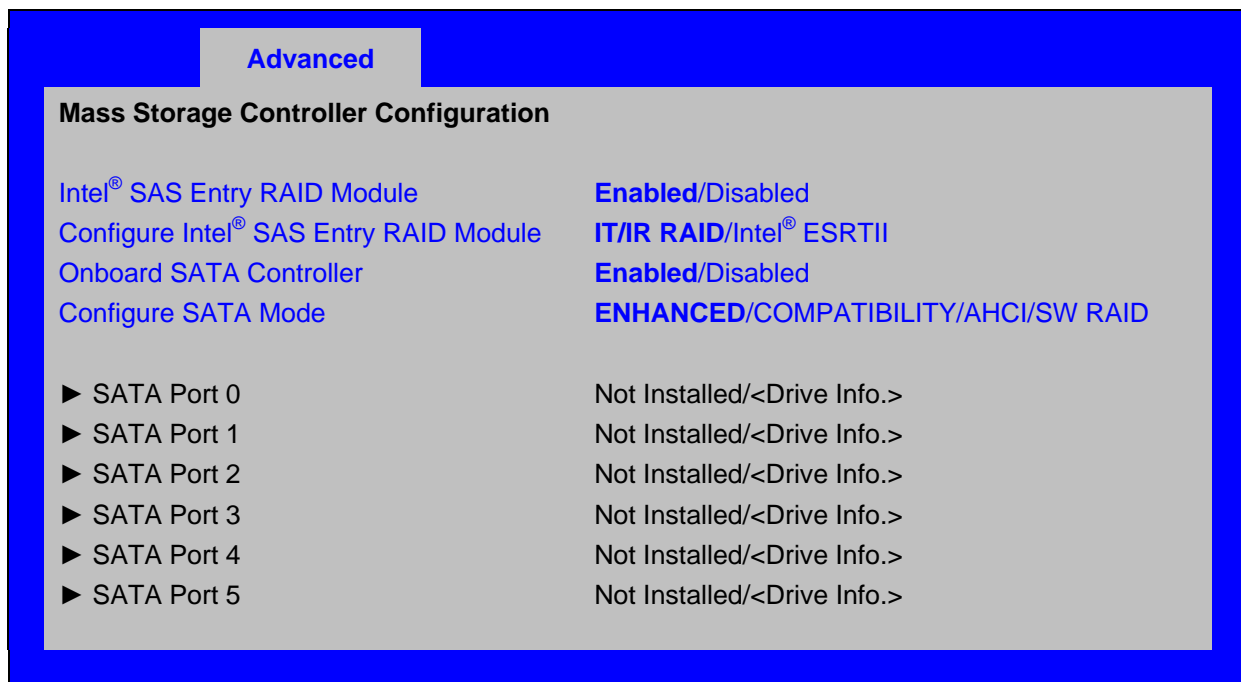

Figure 19. Mass Storage Controller Configuration Screen

6.5.2.7 Serial Port Configuration

The Serial Port Configuration screen allows the user to configure the Serial A [COM 1] and Serial B [COM2] ports.

To access this screen from the **Main** screen, select **Advanced > Serial Port Configuration**. To move to another screen, press the **<Esc>** key to return to the **Advanced** screen, then select the desired screen.

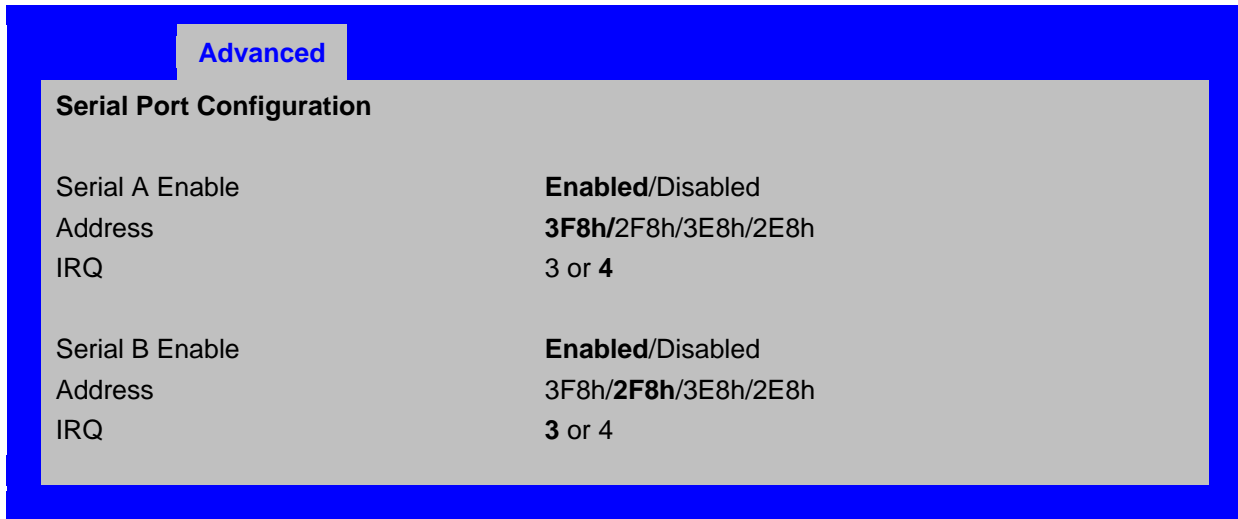

Figure 20. Serial Port Configuration Screen

6.5.2.8 USB Configuration

The USB Configuration screen allows the user to configure the USB controller options.

To access this screen from the Main screen, select **Advanced** > USB Configuration. To move to another screen, press the **<Esc>** key to return to the **Advanced** screen, then select the desired screen.

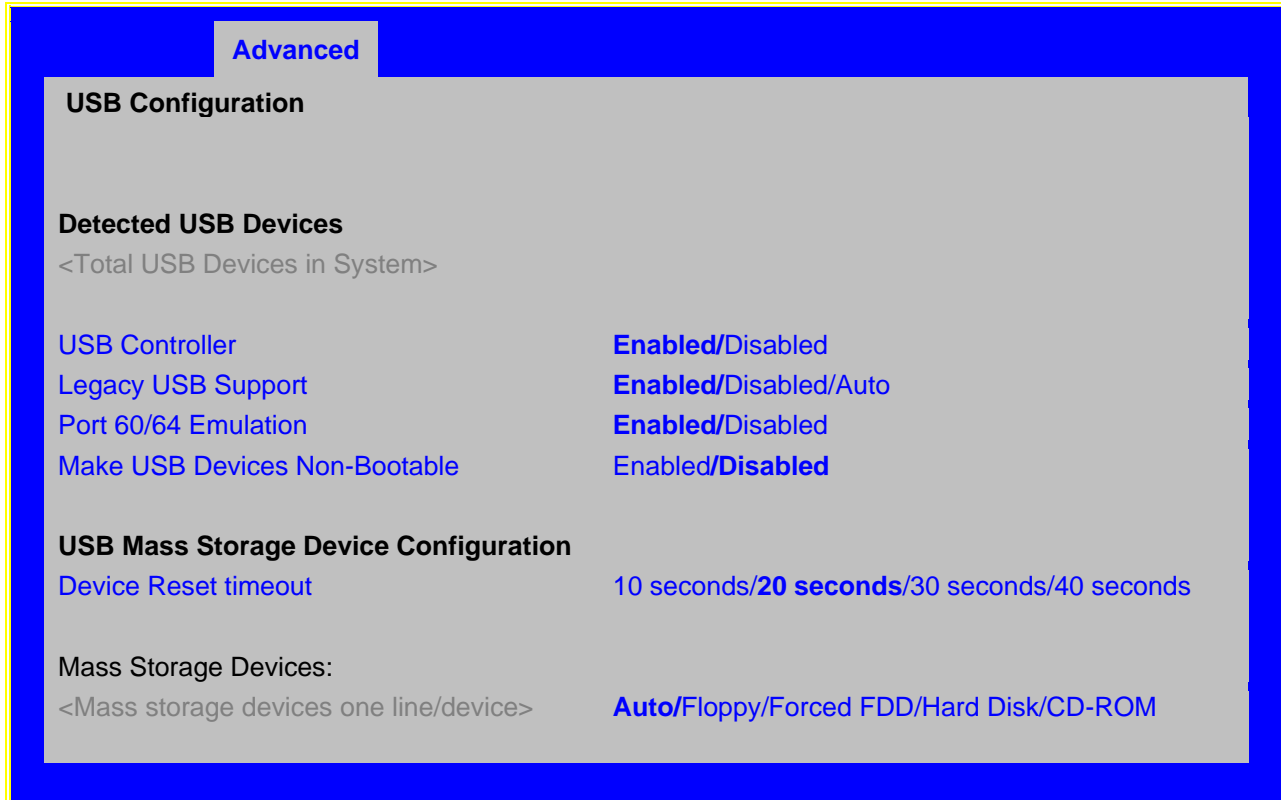

Figure 21. USB Configuration Screen

6.5.2.9 PCI Configuration

The PCI Configuration screen allows the user to configure the PCI memory space used for onboard and add-in adapters, configure video options, and configure onboard adapter options. It also displays the NIC MAC Addresses in use.

To access this screen from the Main screen, select **Advanced > PCI Configuration**. To move to another screen, press the **<Esc>** key to return to the **Advanced** screen, then select the desired screen.

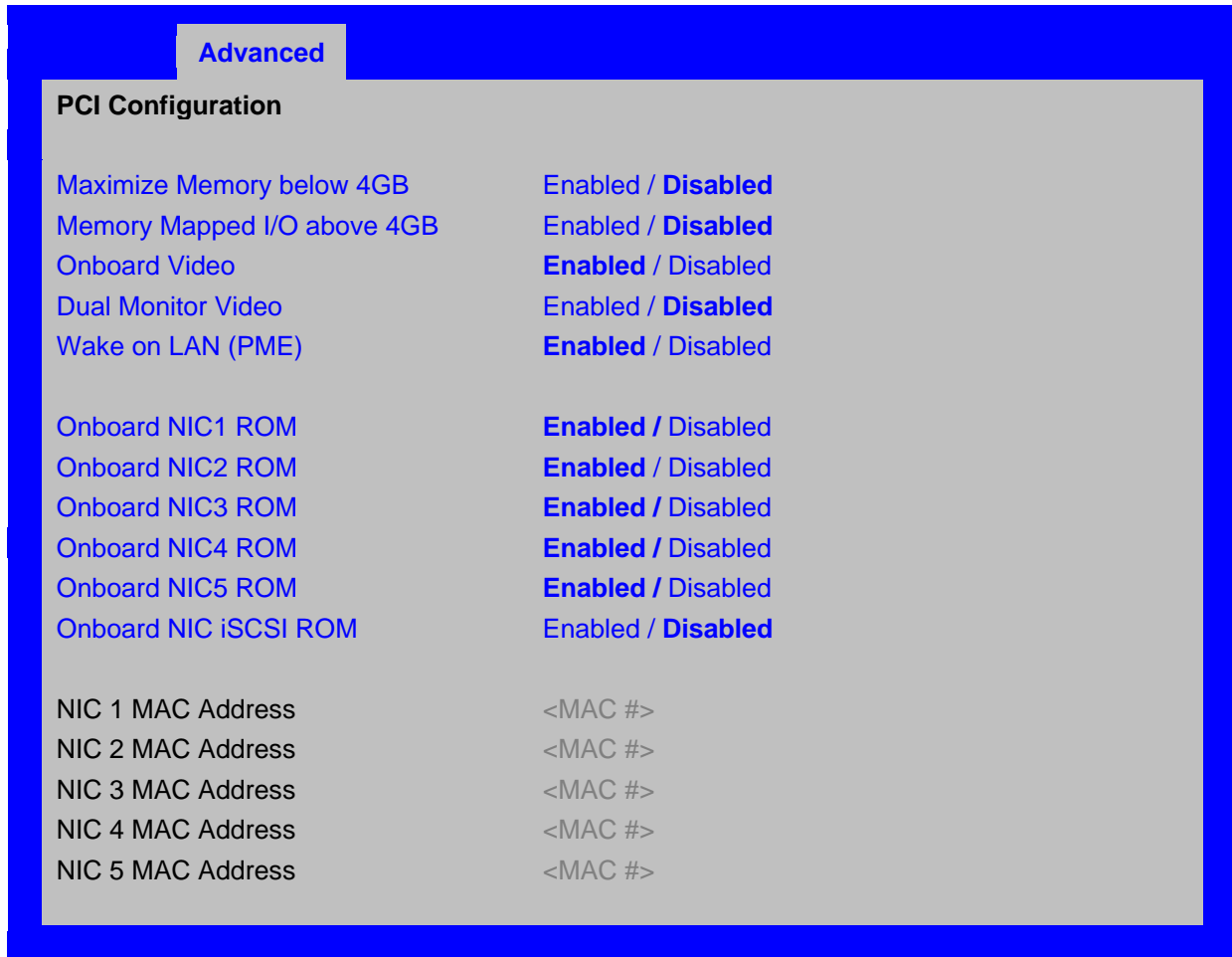

Figure 22. PCI Configuration Screen

10. Wake on LAN (PME)

Option Values: Enabled
 Disabled

Help Text:

Enables or disables PCI PME function for Wake on LAN capability from LAN adapters.

Comments: Enables/disables PCI/PCIe PME# signal to generate Power Management Events (PME) and ACPI Table entries required for Wake on LAN (WOL). However, note that this will enable WOL only with an ACPI-capable Operating System which has the WOL function enabled.

6.5.2.10 System Acoustic and Performance Configuration

The System Acoustic and Performance Configuration screen allows the user to configure the thermal control behavior of the system in order to balance performance and acoustics with power consumption and heat generation.

To access this screen from the **Main** screen, select **Advanced > System Acoustic and Performance Configuration**. To move to another screen, press the **<Esc>** key to return to the **Advanced** screen, then select the desired screen.

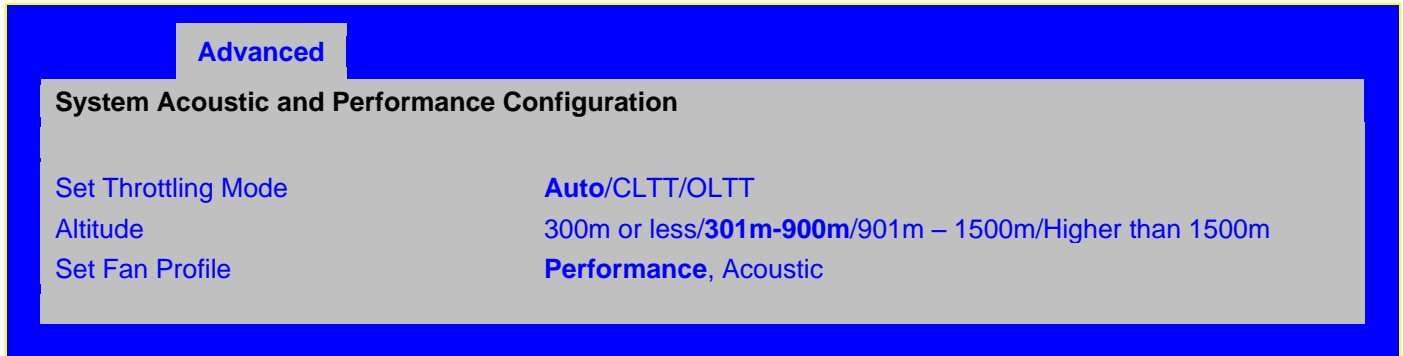

Figure 23. System Acoustic and Performance Configuration

6.5.2.11 Security Screen (Tab)

The Security screen allows the user to enable and set the user and administrative password and to lock out the front panel buttons so they cannot be used. This screen also allows the user to enable and activate the Trusted Platform Module (TPM) security settings on those boards that support TPM.

To access this screen from the **Main** screen or other top-level **Tab** screen, press the right or left arrow keys to traverse the tabs at the top of the **Setup** screen until the **Security** screen is selected.

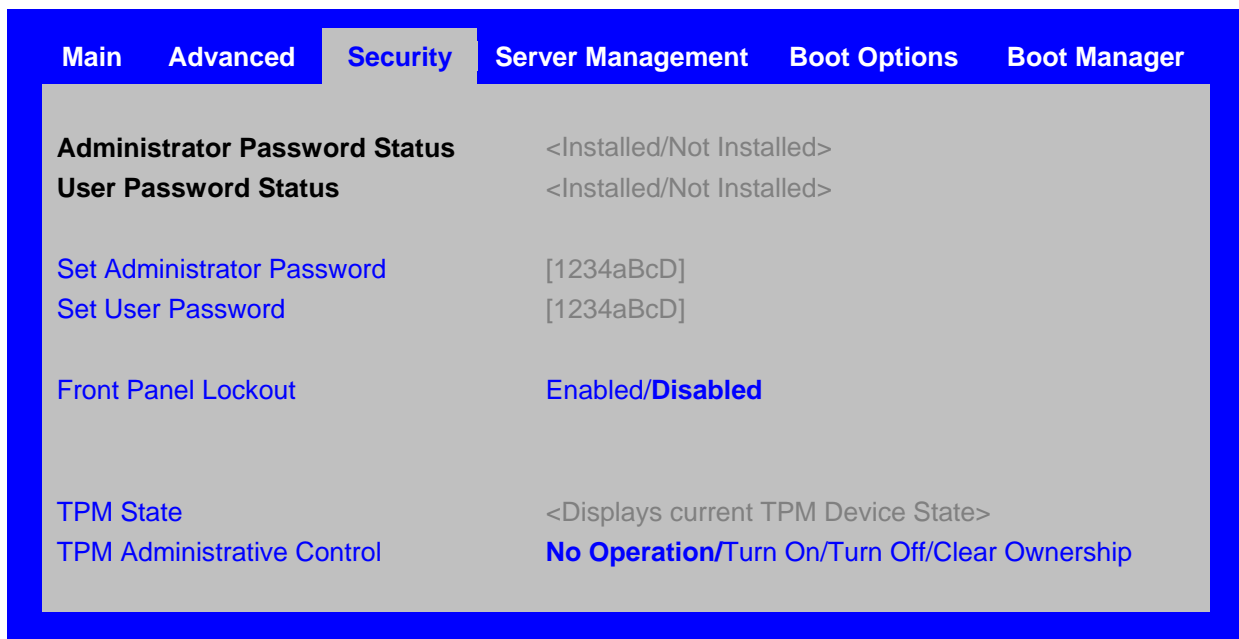

Figure 24. Security Screen

6.5.2.12 Server Management Screen (Tab)

The Server Management screen allows the user to configure several server management features. This screen also provides an access point to the screens for configuring console redirection, displaying system information, and controlling the BMC LAN configuration.

To access this screen from the **Main** screen or other top-level **Tab** screen, press the right or left arrow keys to traverse the tabs at the top of the **Setup** screen until the **Server Management** screen is selected.

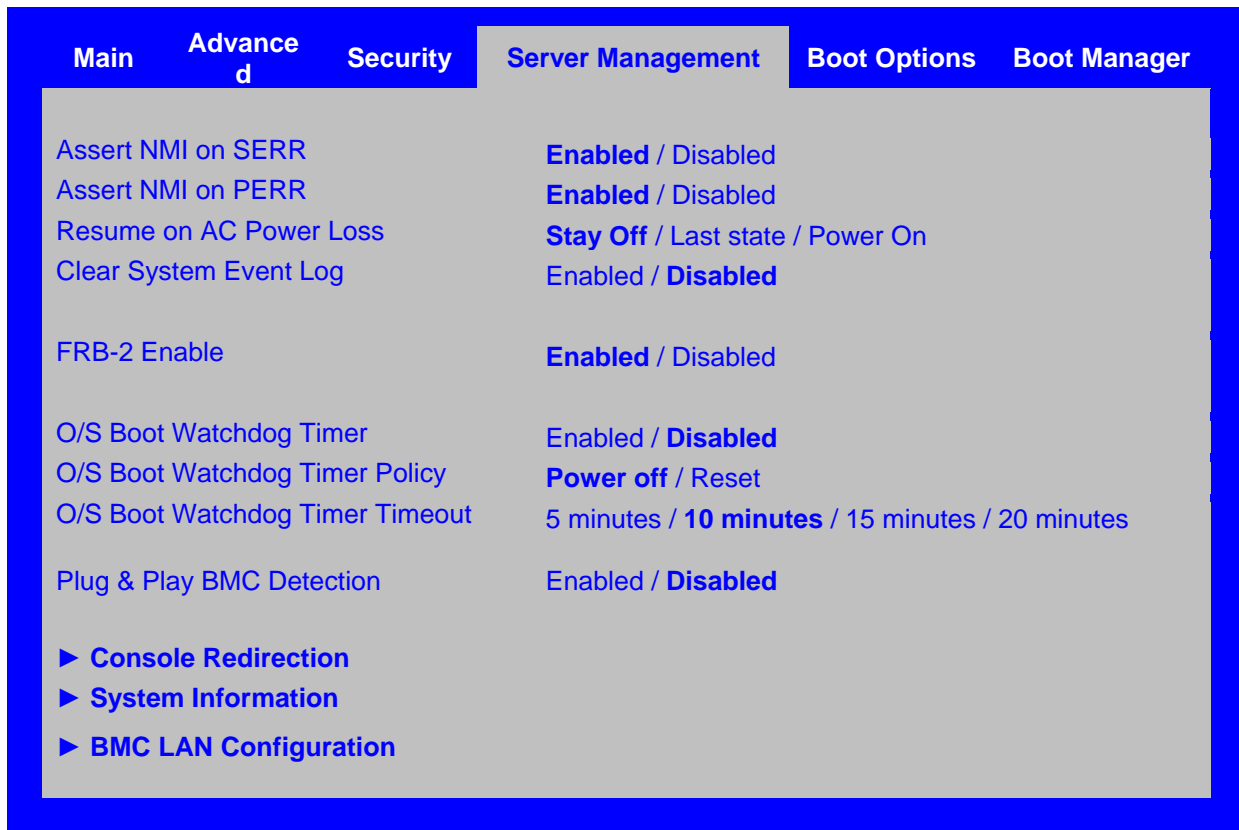

Figure 25. Server Management Screen (S1200BTL)

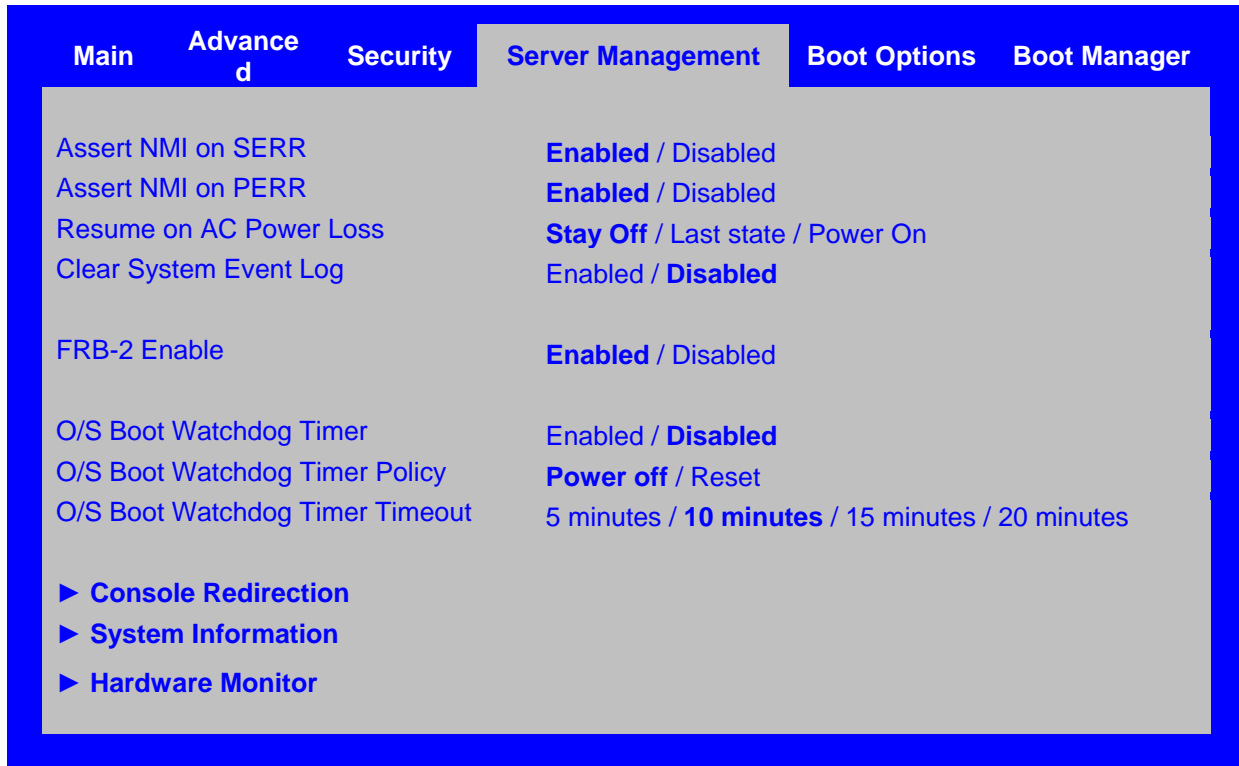

Figure 26. Server Management Screen (S1200BTS)

6.5.2.13 Console Redirection

The Console Redirection screen allows the user to enable or disable console redirection and to configure the connection options for this feature.

To access this screen from the **Main** screen, select **Server Management > Console Redirection**. To move to another screen, press the **<Esc>** key to return to the **Server Management** screen, then select the desired screen.

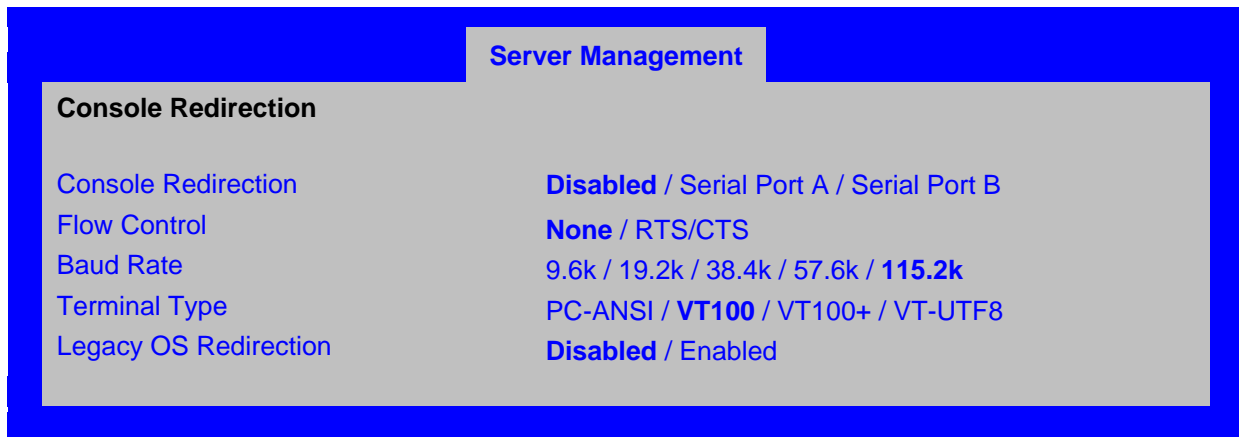

Figure 27. Console Redirection Screen

6.5.2.14 System Information

The System Information screen allows the user to view part numbers, serial numbers, and firmware revisions.

To access this screen from the **Main** screen, select **Server Management > System Information**. To move to another screen, press the **<Esc>** key to return to the **Server Management** screen, then select the desired screen.

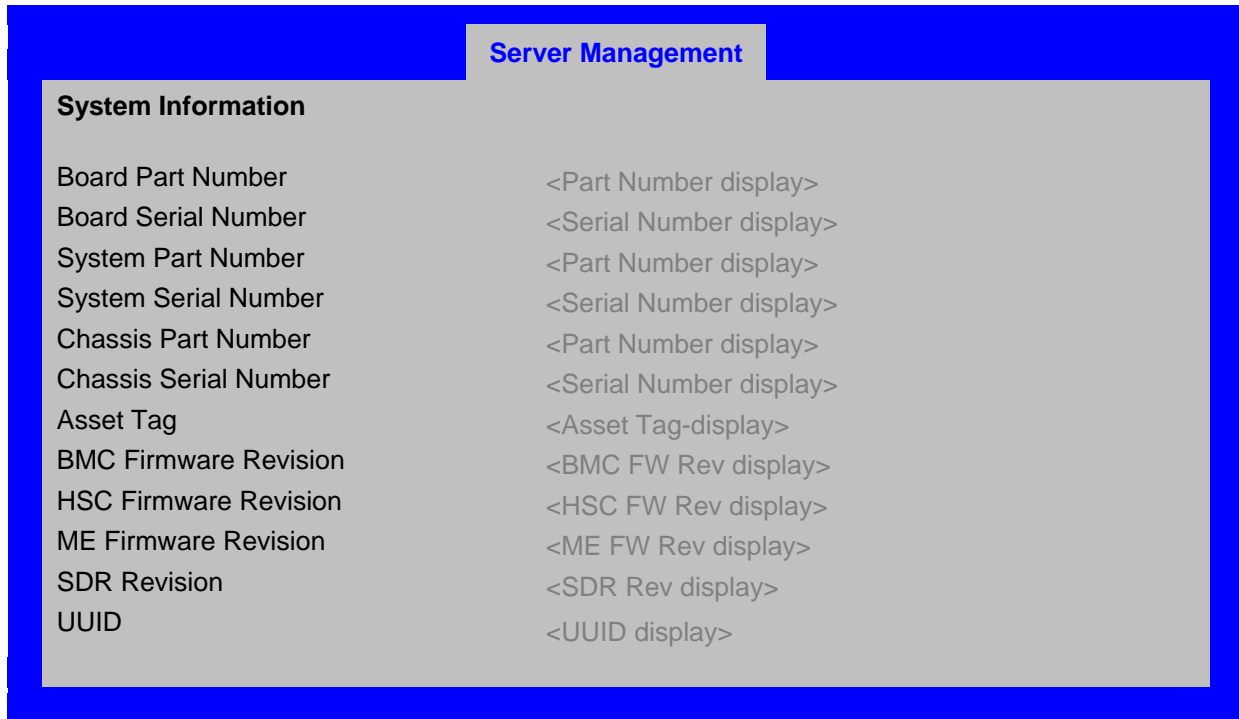

Figure 28. System Information Screen (S1200BTL)

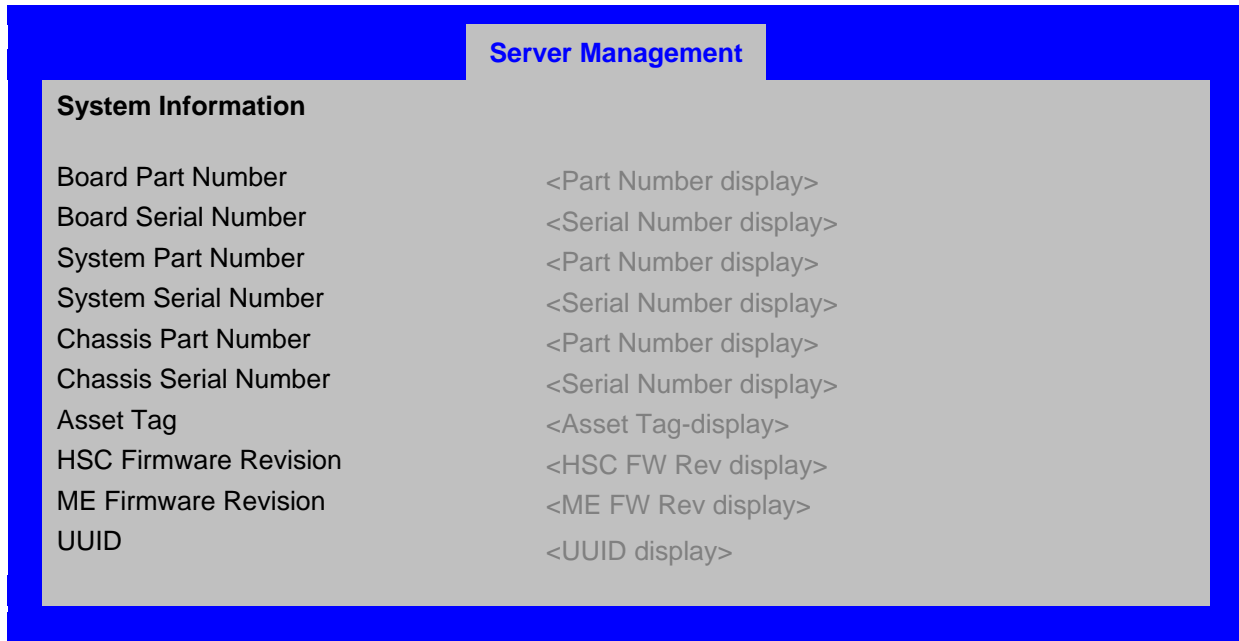

Figure 29. System Information Screen (S1200BTS)

6.5.2.15 BMC LAN Configuration

The BMC configuration screen allows the Setup user to configure the BMC Baseboard LAN channel and the RMM4 LAN channel, and to manage BMC User settings for up to five BMC Users.

To access this screen from the Main screen, select **Server Management > System Information**. To move to another screen, press the **<Esc>** key to return to the **Server Management** screen, then select the desired screen.

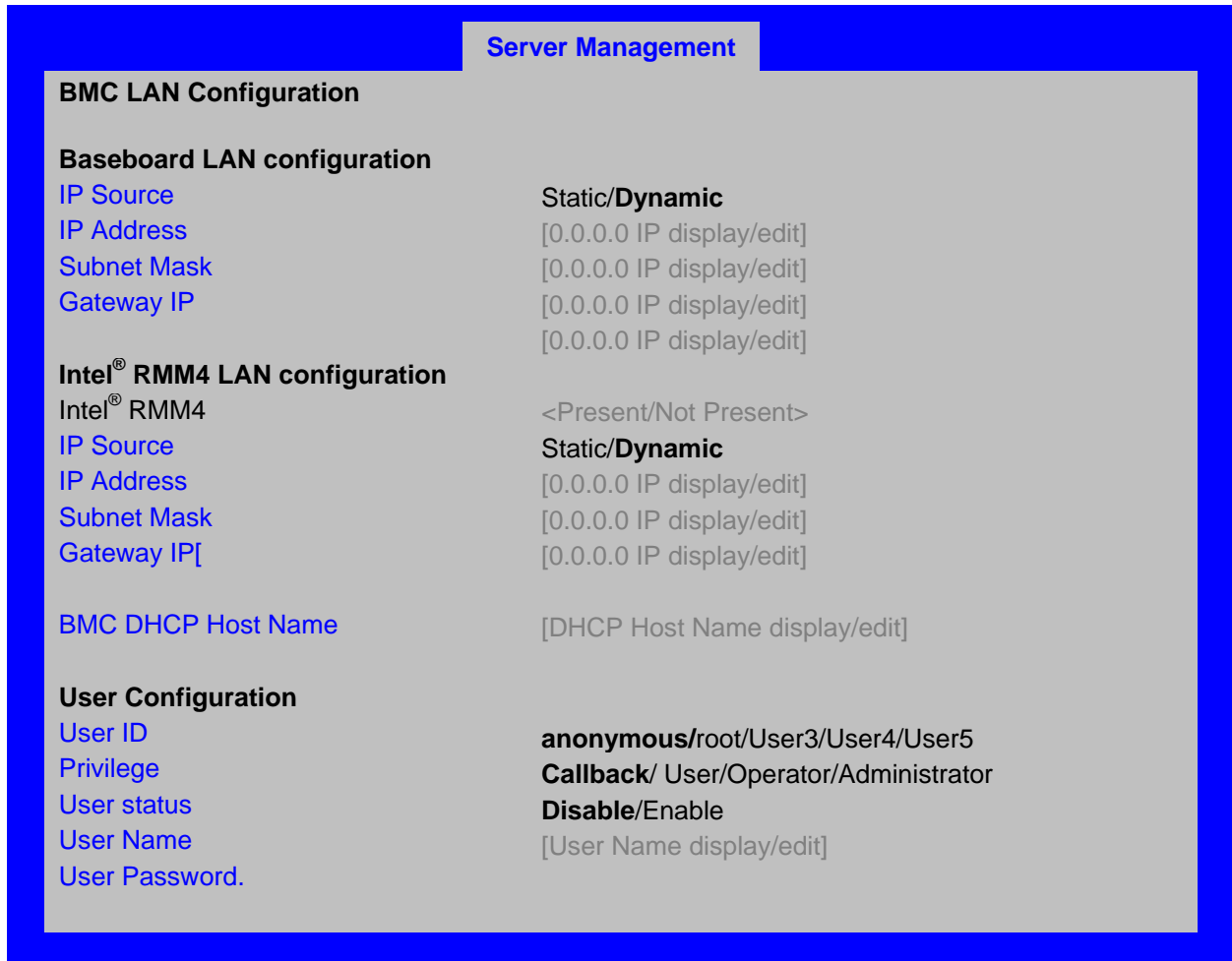

Figure 30. BMC LAN Configuration Screen (S1200BTL)

6.5.2.16 Hardware Monitor

The Hardware Monitor screen allows the user to configure Fan Speed Control and to view displays of temperature and voltage status.

To access this screen from the **Main** screen, select **Server Management > Hardware Monitor**. To move to another screen, press the **<Esc>** key to return to the **Server Management** screen, then select the desired screen.

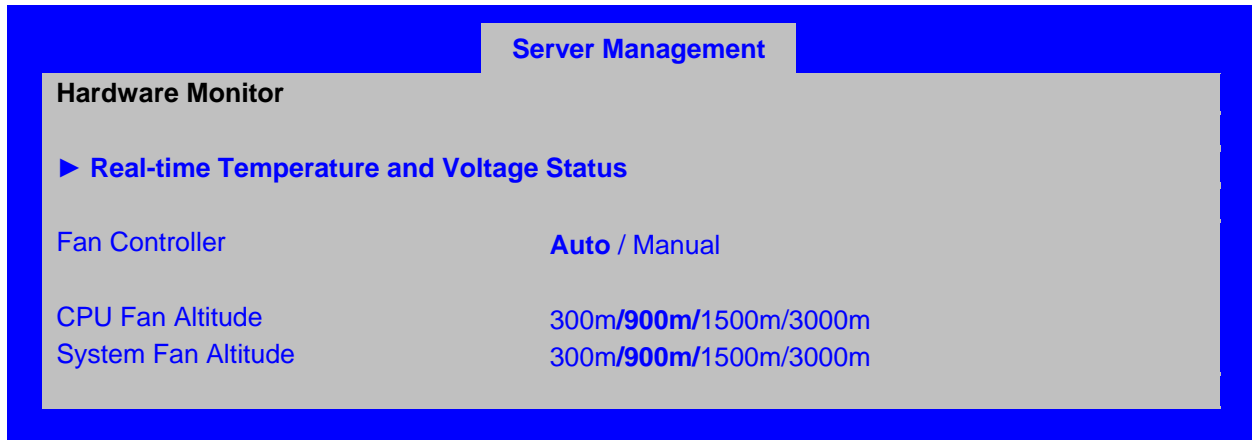

Figure 31. Hardware Monitor Screen, Auto Fan Control (S1200BTS)

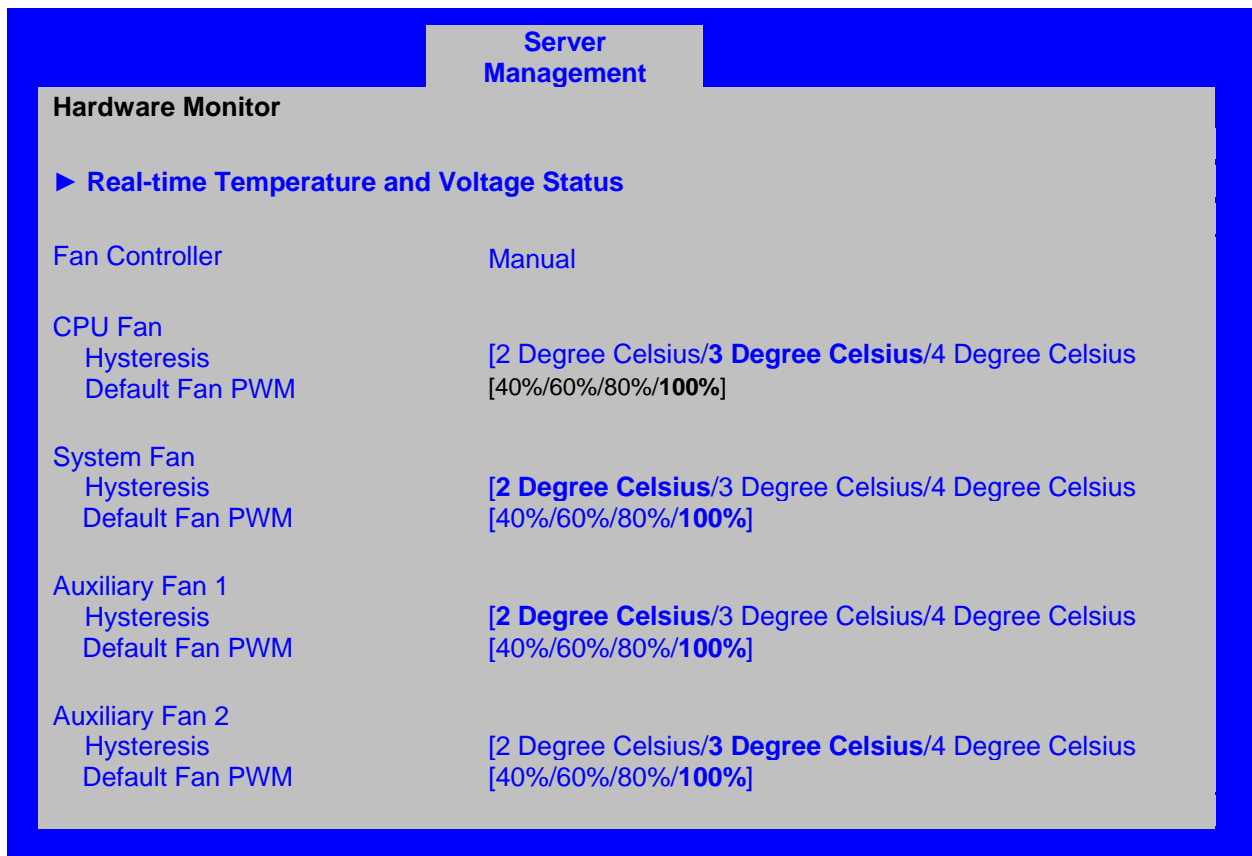

Figure 32. Hardware Monitor Screen, Manual Fan Control (S1200BTS)

6.5.2.17 Realtime Temperature and Voltage Status

The Realtime Temperature and Voltage Status screen allows the user to view displays of current processor and system fan speeds, current system temperature, and the status of various voltages which are monitored on the board.

To access this screen from the Main screen, select **Server Management > Hardware Monitor > Realtime Temperature and Voltage Status**. To move to another screen, press the **<Esc>** key to return to the **Hardware Monitor** screen, if necessary press the **<Esc>** key again to return to the **Server Management** screen, then select the desired screen.

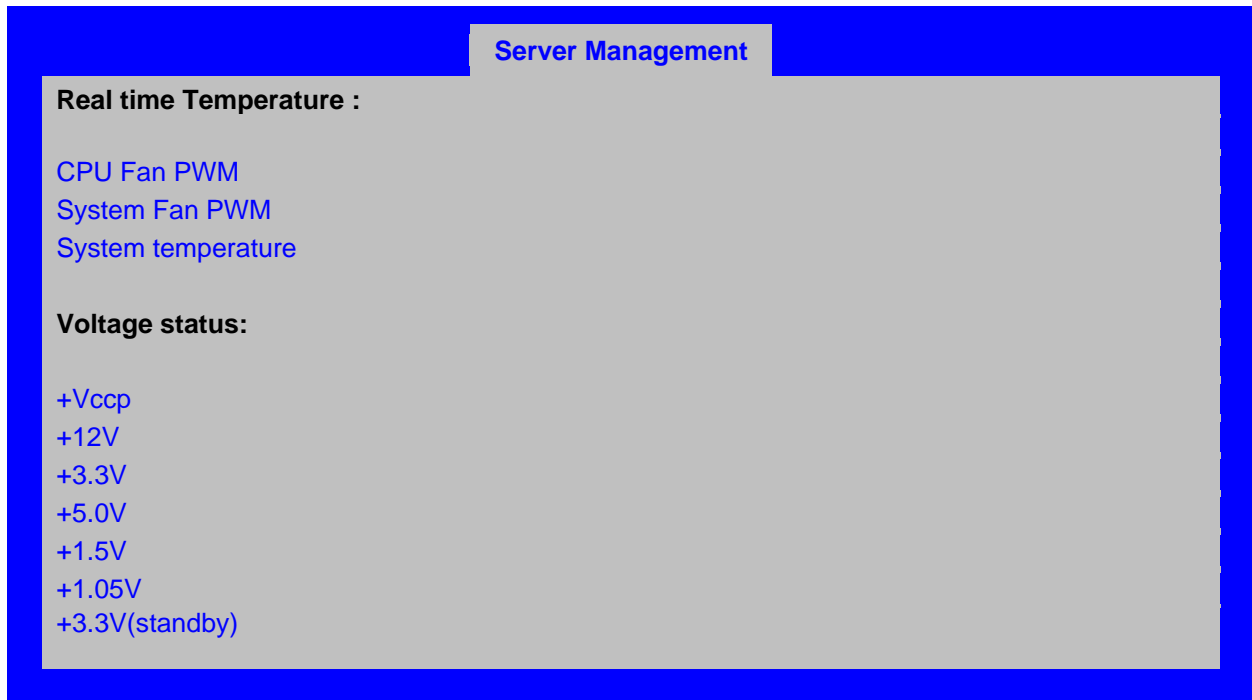

Figure 33. Realtime Teperature and Voltage Status Screen (S1200BTS)

6.5.2.18 Boot Options Screen (Tab)

The Boot Options screen displays any bootable media encountered during POST, and allows the user to configure the desired order in which boot devices are to be tried. The first boot device in the specified Boot Order which is present and bootable during POST will be used to boot the system any time the system is rebooted after that.

To access this screen from the **Main** screen or other top-level **Tab** screen, press the right or left arrow keys to traverse the tabs at the top of the **Setup** screen until the **Boot Options** screen is selected.



Figure 34. Boot Options Screen

6.5.2.19 Hard Disk Order

The Hard Disk Order screen allows the user to control the order in which BIOS attempts to boot from the hard disk drives installed in the system. This screen is only available when there is at least one hard disk device available in the system configuration.

Note: A USB Hard Disk drive or a USB Key device formatted as a hard disk will appear in this section.

To access this screen from the Main screen, select **Boot Options > Hard Disk Order**. To move to another screen, press the **<Esc>** key to return to the **Boot Options** screen, then select the desired screen.

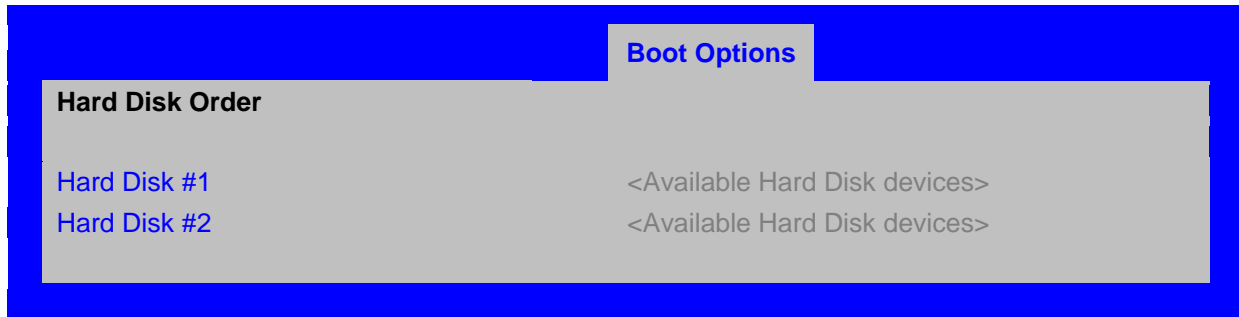

Figure 35. Hard Disk Order Screen

6.5.2.20 CDROM Order

The CDROM Order screen allows the user to control the order in which BIOS attempts to boot from the CDROM drives installed in the system. This screen is only available when there is at least one CDROM device available in the system configuration.

Note: A USB CDROM device will appear in this section.

To access this screen from the Main screen, select **Boot Options > CDROM Order**. To move to another screen, press the **<Esc>** key to return to the **Boot Options** screen, then select the desired screen.

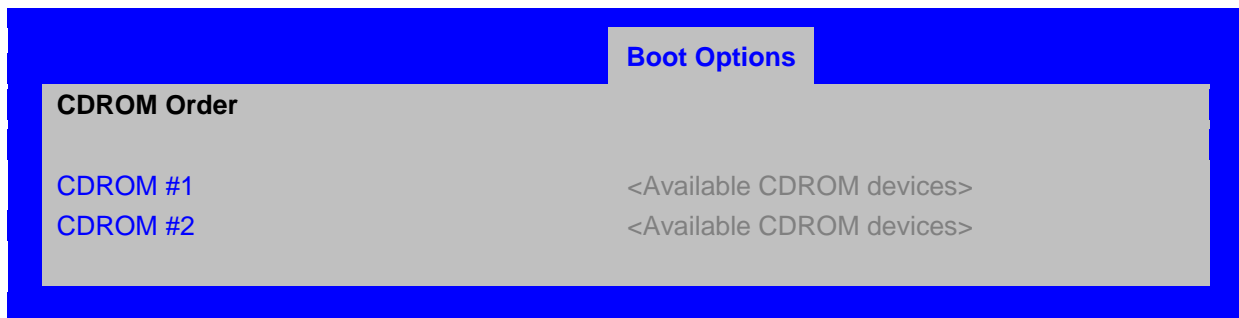

Figure 36. CDROM Order Screen

6.5.2.21 Floppy Order

The Floppy Order screen allows the user to control the order in which BIOS attempts to boot from the Floppy Disk drives installed in the system. This screen is only available when there is at least one Floppy Disk (diskette) device available in the system configuration.

Note: A USB Floppy drive or a USB Key device formatted as a diskette drive will appear in this section.

To access this screen from the Main screen, select **Boot Options > Floppy Order**. To move to another screen, press the **<Esc>** key to return to the **Boot Options** screen, then select the desired screen.

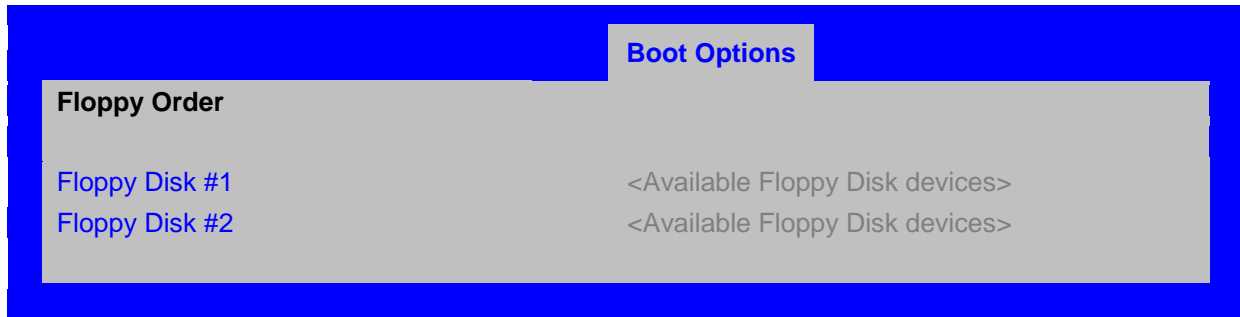

Figure 37. Floppy Order Screen

6.5.2.22 Network Device Order

The Network Device Order screen allows the user to control the order in which BIOS attempts to boot from the network bootable devices installed in the system. This screen is only available when there is at least one network bootable device available in the system configuration.

To access this screen from the Main screen, select **Boot Options > Network Device Order**. To move to another screen, press the **<Esc>** key to return to the **Boot Options** screen, then select the desired screen.

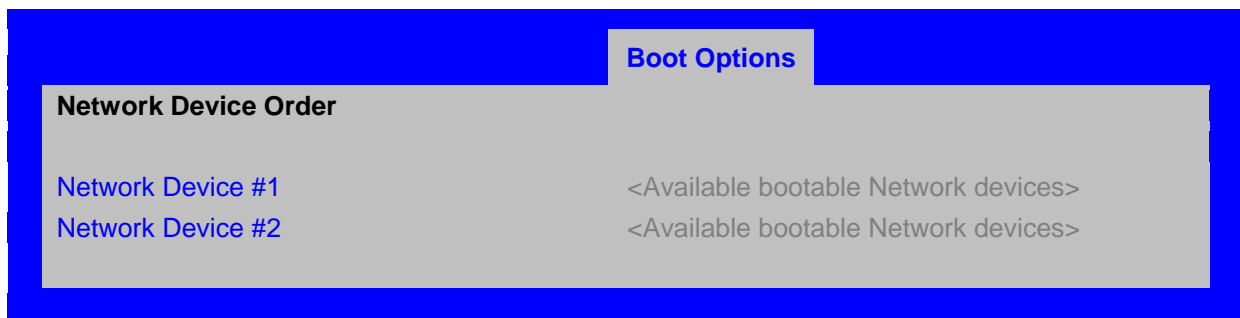

Figure 38. Network Device Order Screen

6.5.2.23 BEV Device Order

The BEV Device Order screen allows the user to control the order in which BIOS attempts to boot from the BEV Devices installed in the system. This screen is only available when there is at least one BEV device available in the system configuration.

To access this screen from the Main screen, select **Boot Options > BEV Device Order**. To move to another screen, press the **<Esc>** key to return to the **Boot Options** screen, then select the desired screen.

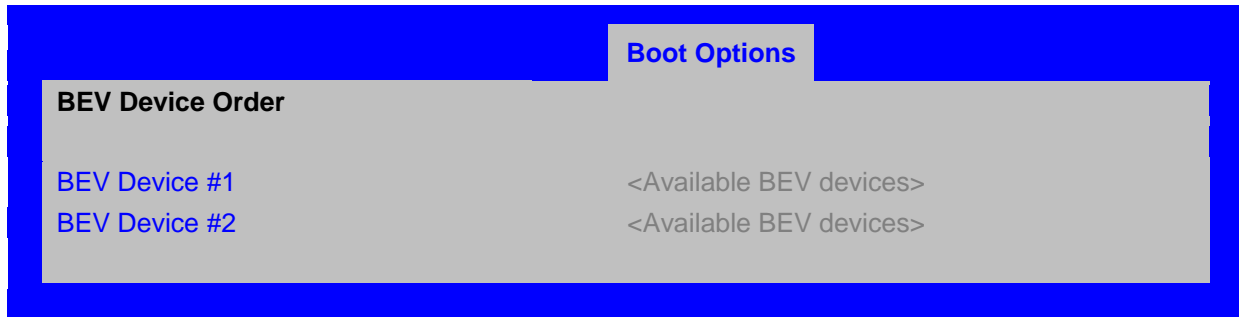

Figure 39. BEV Device Order Screen

6.5.2.24 Add EFI Boot Option

The Add EFI Boot Option screen allows the user to add an EFI boot option to the boot order. This screen is only available when there is at least one EFI bootable device present in the system configuration. The “Internal EFI Shell” Boot Option is permanent and cannot be added or deleted.

To access this screen from the **Main** screen, select **Boot Options > Add EFI Boot Option**. To move to another screen, press the **<Esc>** key to return to the **Boot Options** screen, then select the desired screen.

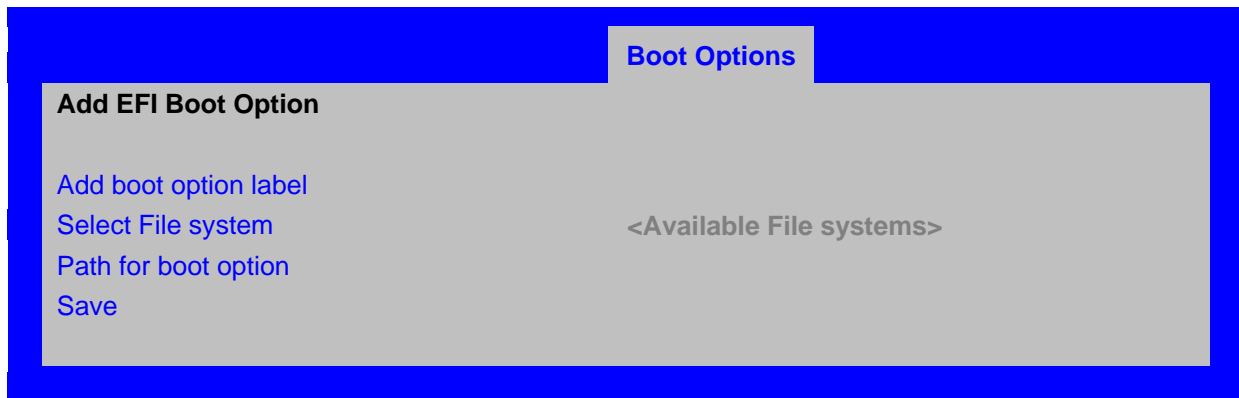

Figure 40. Add EFI Boot Option Screen

6.5.2.25 Delete EFI Boot Option

The Delete EFI Boot Option screen allows the user to remove an EFI boot option from the boot order. The “Internal EFI Shell” Boot Option will not be listed, since it is permanent and cannot be added or deleted.

To access this screen from the Main screen, select **Boot Options > Delete EFI Boot Option**. To move to another screen, press the **<Esc>** key to return to the **Boot Options** screen, then select the desired screen.

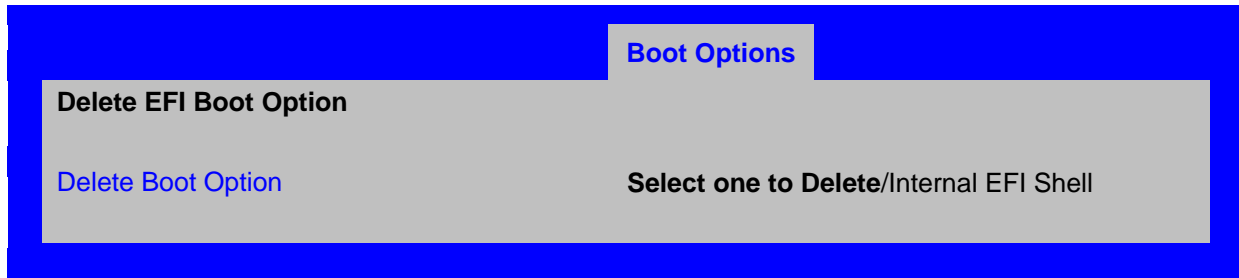

Figure 41. Delete EFI Boot Option Screen

6.5.2.26 Boot Manager Screen (Tab)

The Boot Manager screen allows the user to view a list of devices available for booting, and to select a boot device for immediately booting the system.

Note: This list is not in order according to the system Boot Option order. The “Internal EFI Shell” will always be available, regardless of whether any other bootable devices are available.

To access this screen from the **Main** screen or other top-level **Tab** screen, press the right or left arrow keys to traverse the tabs at the top of the Setup screen until the **Boot Manager** screen is selected.

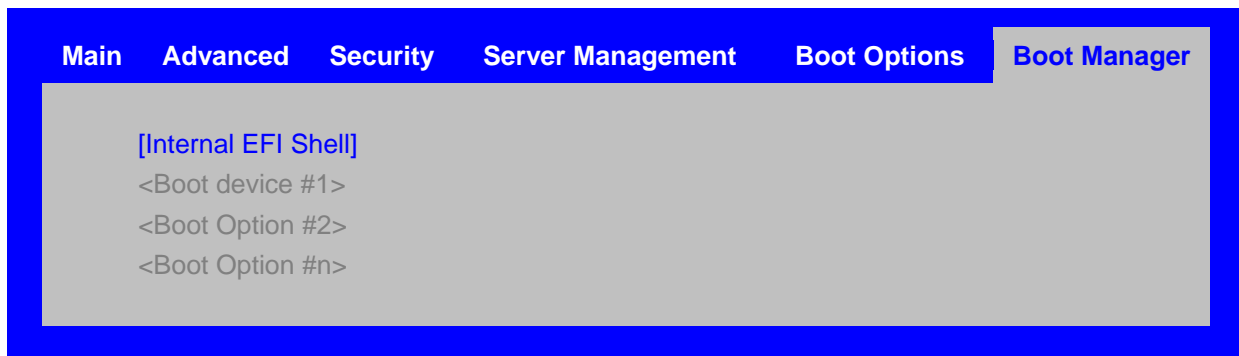

Figure 42. Boot Manager Screen

6.5.2.27 Error Manager Screen (Tab)

The Error Manager screen displays any POST Error Codes encountered during BIOS POST, along with an explanation of the meaning of the code.

To access this screen from the **Main** screen or other top-level **Tab** screen, press the right or left arrow keys to traverse the tabs at the top of the **Setup** screen until the **Error Manager** screen is selected.

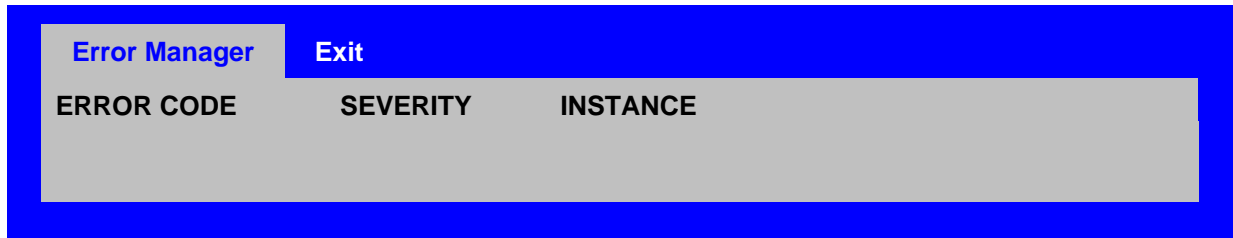

Figure 43. Error Manager Screen

6.5.2.28 System Event Log Screen (Tab)

The System Event Log screen appears only for server boards (other than Compute Module boards) which do not have an onboard Baseboard Management Controller. These boards maintain the System Event Log internally by using the SMBIOS Type 15 mechanism.

The System Event Log viewer can display as many log records as are stored in a single page. Each Event Record is displayed on one line. The most recent Event Record is displayed on the top. When there are more Event Records that can be displayed at once, the **<PageUp>** and **<PageDown>** keys can be used. There is also a scroll bar to allow users to view the logs from beginning to the end.

Note: When the System Event Log is full, or when the user wishes to remove the current Event Records, the user can choose **Clear System Event Log** in **Setup**.

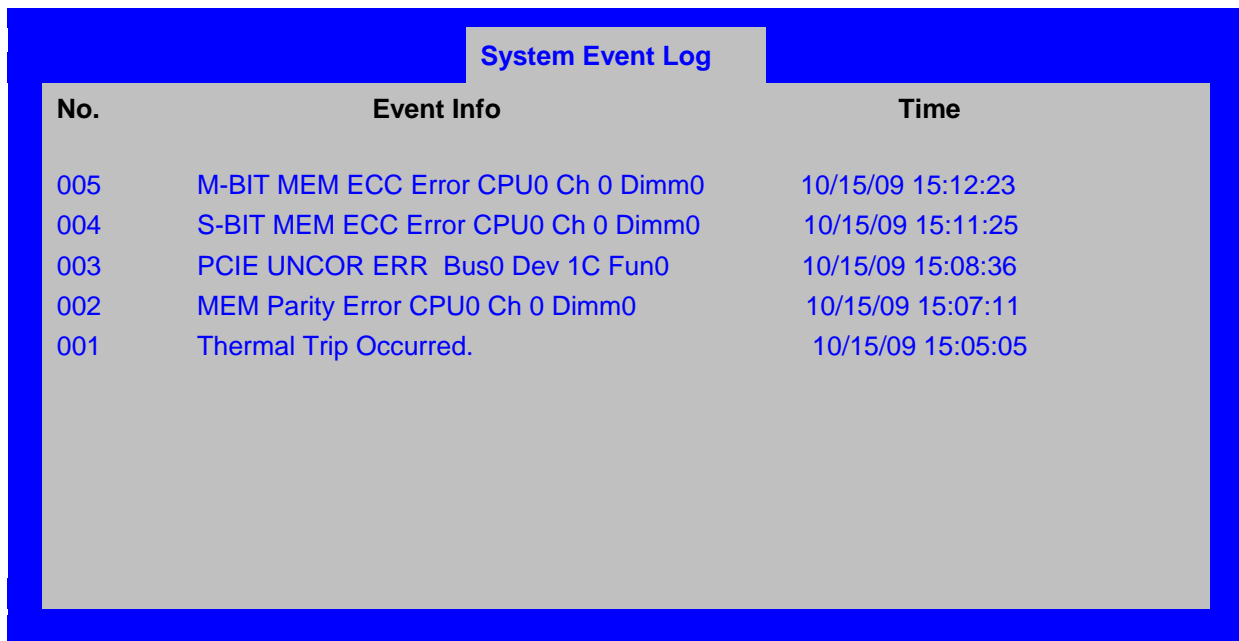

Figure 44. System Event Log Screen (S1200BTS)

6.5.2.29 Exit Screen (Tab)

The Exit screen allows the user to choose whether to save or discard the configuration changes made on other Setup screens. It also allows the user to restore the BIOS settings to the factory defaults or to save or restore them to a set of user-defined default values. If Load Default Values is selected, the factory default settings (noted in bold in the tables in this chapter) are applied. If Load User Default Values is selected, the system is restored to previously saved user-defined default values.

To access this screen from the **Main** screen or other top-level “Tab” screen, press the right or left arrow keys to traverse the tabs at the top of the **Setup** screen until the **Exit** screen is selected.

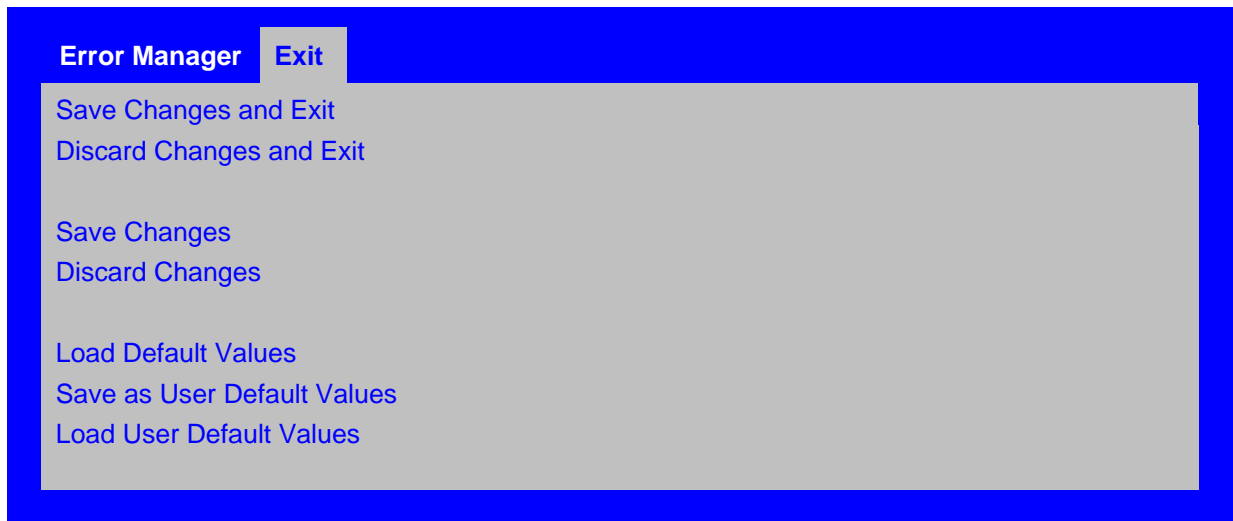

Figure 45. Exit Screen

7. Connector/Header Locations and Pin-outs

7.1 Board Connector Information

The following section provides detailed information regarding all connectors, headers, and jumpers on the server board. It lists all connector types available on the board and the corresponding reference designators printed on the silkscreen.

Table 17. Board Connector Matrix on S1200BTL

Connector	Quantity	Reference Designators	Connector Type	Pin Count
Power supply	3	J9G1, J9A1, J9F1	Main power CPU power P/S aux	24 8 5
CPU	1	J7D1	CPU sockets	1155
Main memory	4	J8H1, J8H2, J8H3, J9H1	DIMM sockets	240
Intel® RMM4 Lite	1	J4B1	Header	8
Intel® RMM4 Dedicated NIC	1	J5C1	Header	30
SAS Module	1	J2H1	Header	50
CPU Fan	1	J5J1	Header	4
System Fans	4	J1J4, J5J2, J7J1, J7B1	Header	4
Battery	1	BT5B1	Battery holder	3
NIC/Stack 2x USB	2	J5A1, J6A1	Dual USB	8
Video	1	J7A1	External DSub	15
Serial port A	1	J8A1	Connector	9
Serial port B	1	J1B2	Header	9
Front panel	1	J1C1	Header	24
Dual- USB Internal Header	2	J1D1, J1E1	Header	10
PCI-E x16	1	J4B3	Card Edge	164
PCI-E x8	3	J2B2, J3B1, J4B2	Card Edge	98
PCI 32	1	J1B1	Card Edge	120
Chassis Intrusion	1	J4A1	Header	2
6Gb/s Serial ATA	2	J1H1, J1H3	Header	7
3Gb/s Serial ATA	4	J1H4, J1H2, J1G1, J1F4	Header	7
IPMB	1	J1H5	Header	4
HSBP	1	J1J2	Header	4
Smart Module	1	J3F2	Header	10
SATA RAID key	1	J4A3	Header	4
SATA_SGPIO	1	J1J3	Header	4

Table 18. Board Connector Matrix on S1200BTS

Connector	Quantity	Reference Designators	Connector Type	Pin Count
Power supply	2	J9G1, J9A1	Main power CPU power	24 8
CPU	1	J5J1	CPU sockets	1155
Main memory	4	J8H1, J8H2, J8H3, J9H1	DIMM sockets	240
CPU Fan	1	J4J1	Header	4
System Fans	3	J2J3, J7J1, J7B1	Header	4
Battery	1	BT2E1	Battery holder	3
NIC/Stack 2x USB	2	JA4A1, JA5A1	Dual USB	8
Video	1	J6A1	External DSub	15
Serial port A	1	J8A1	Connector	9
Front panel	1	J1C2	Header	24
USB Internal Header	1	J1E1	Header	10
PCI-E x16	1	J4B1	Card Edge	164
PCI-E x8	2	J2B1, J3B1	Card Edge	98
PCI 32	1	J1B1	Card Edge	120
Chassis Intrusion	1	J3G1	Header	2
3Gb/s Serial ATA	6	J1J1, J1J2, J1J3, J1J4, J1H1, J1H2	Header	7
SATA RAID key	1	J3A1	Header	4
SATA_SGPIO	1	J1J2	Header	4

7.2 Power Connectors

The main power supply connection uses an SSI-compliant 2x12 pin connector (J9G1). In addition, there is one additional power related connector:

- One SSI-compliant 2x4 pin power connector (J9G1), which provides 12-V power to the CPU VRD.

The following tables define the connector pin-outs:

Table 19. Baseboard Power Connector Pin-out (J9G1)

Pin	Signal	Pin	Signal
1	+3.3 Vdc	13	+3.3 Vdc
2	+3.3 Vdc	14	-12 Vdc
3	GND	15	GND
4	+5 Vdc	16	PS_ON#
5	GND	17	GND
6	+5 Vdc	18	GND
7	GND	19	GND
8	PWRGD_PS	20	NC
9	5 VSB	21	+5 Vdc
10	+12 Vdc	22	+5 Vdc

Pin	Signal	Pin	Signal
11	+12 Vdc	23	+5 Vdc
12	+3.3 Vdc	24	GND

Table 20. SSI Processor 8-PIN Power Connector Pin-out (J9A1)

Pin	Signal	Pin	Signal
1	GND	5	P12V1
2	GND	6	P12V1
3	GND	7	P12V1
4	GND	8	P12V1

7.3 System Management Headers

7.3.1 Intel® Remote Management Module 4 (Intel® RMM4) Lite connector and Dedicated NIC connector

An Intel® RMM 4 lite connector (J4B1) is included on the server board to support the optional Intel® Remote Management Module 4 lite. This server board does not support third-party management cards.

Note: This connector is not compatible with the Intel® Remote Management Module (Intel® RMM), the Intel® Remote Management Module 2 (Intel® RMM2) or the Intel® Remote Management Module 3 (Intel® RMM3)

Table 21. Intel® RMM4 lite Connector Pin-out (J4B1)

Pin	Name	Pin	Name
1	VCC	2	DI
3	KEY	4	CLK
5	DO	6	GND
7	CS_N	8	GND

There is an Intel® Remote Management Module 4 (Intel® RMM4) Dedicated NIC connector (J5C1).

Table 22. Dedicated NIC connector for RMM4

Pin	Name	Pin	Name
1	3V3_AUX	2	MDIO
3	3V3_AUX	4	MDC
5	GND	6	TXD_0
7	GND	8	TXD_1
9	GND	10	TXD_2
11	GND	12	TXD_3
13	GND	14	TX_CTL
15	GND	16	RX_CTL

Pin	Name	Pin	Name
17	GND	18	RXD_0
19	GND	20	RXD_1
21	GND	22	RXD_2
23	GND	24	RXD_3
25	GND	26	TX_CLK
27	GND	28	RX_CLK
29	GND	30	PRESENT#

7.3.2 LPC/IPMB Header

Table 23. LPC/IPMB Header Pin-out (J1H5)

Pin	Signal Name	Description
1	SMB_IPMB_5VSB_DAT	Integrated BMC IMB 5V standby data line
2	GND	Ground
3	SMB_IPMB_5VSB_CLK	Integrated BMC IMB 5V standby clock line
4	P5V_STBY	+5 V standby power

7.3.3 HSBP Header

Table 24. HSBP Header Pin-out (J1J2)

Pin	Signal Name
1	SMB_HSBP_5V_DAT
2	GND
3	SMB_HSBP_5V_CLK
4	FM_HSBP_ADD_C2

7.3.4 SGPIO Header

Table 25. SGPIO Header Pin-out (J1J3 on S1200BTL and J2J2 on S1200BTS)

Pin	Signal Name	Description
1	SGPIO_CLOCK	SGPIO Clock Signal
2	SGPIO_LOAD	SGPIO Load Signal
3	GND	
4	SGPIO_DATAOUT0	SGPIO Data Out
5	SGPIO_DATAOUT1	SGPIO Data In

7.4 Front Control Panel Connector

The server board provides a 24-pin SSI front panel connector (J1C1) for use with Intel® and third-party chassis. The following table provides the pin-out for this connector.

Table 26. Front Panel SSI Standard 24-pin Connector Pin-out (J1C1 on S1200BTL or J1C2 on S1200BTS)

Pin	Signal Name	Pin	Signal Name
1	P3V3_AUX	2	P3V3_AUX
3	NC	4	P5V_STBY
5	PWR_LED_N	6	TP_LED_ID_N
7	P3V3	8	LED_STS_GREEN_N
9	LED_HDD_ACT_N	10	LED_STS_AMBER_N
11	FP_PWR_BTN_N	12	LED_NIC1_ACT
13	GND	14	LED_NIC1_LINK_N
15	FP_RST_BTN_N	16	SMB_SEN_3V3SB_DAT
17	GND	18	SMB_SEN_3V3SB_CLK
19	FP_ID_BTN_N	20	INTRUDER_HDR
21	PU_FM_SIO_TEMP_SENSOR	22	LED_NIC2_ACT
23	FP_NMI_BTN_N	24	LED_NIC2_LINK_N

Combined system BIOS and the Integrated BMC support provide the functionality of the various supported control panel buttons and LEDs. The following sections describe the supported functionality of each control panel feature.

Note: Control panel features are also routed through the bridge board connector at location J1C1 as is implemented in Intel® Server Systems configured using a bridge board and a hot-swap backplane.

7.4.1 Power Button

The BIOS supports a front control panel power button. Pressing the power button initiates a request that the Integrated BMC forwards to the ACPI power state machines in the chipset. It is monitored by the Integrated BMC and does not directly control power on the power supply.

- **Power Button — Off to On**
The Integrated BMC monitors the power button and the wake-up event signals from the chipset. A transition from either source results in the Integrated BMC starting the power-up sequence. Since the processor are not executing, the BIOS does not participate in this sequence. The hardware receives the power good and reset signals from the Integrated BMC and then transitions to an ON state.
- **Power Button — On to Off (Operating system absent)**
The System Control Interrupt (SCI) is masked. The BIOS sets up the power button event to generate an SMI and checks the power button status bit in the ACPI hardware registers when an SMI occurs. If the status bit is set, the BIOS sets the ACPI power state of the machine in the chipset to the OFF state. The Integrated BMC monitors power state signals from the chipset and de-asserts PS_PWR_ON to the power supply. As a safety mechanism, if the BIOS fails to service the request, the Integrated BMC automatically powers off the system in 4 to 5 seconds.
- **Power Button — On to Off (Operating system present)**
If an ACPI operating system is running, pressing the power button switch generates a request using SCI to the operating system to shut down the system. The operating system retains control of the system and the operating system policy determines the sleep state into which the system transitions, if any. Otherwise, the BIOS turns off the system.

7.4.2 Reset Button

The platform supports a front control panel reset button. Pressing the reset button initiates a request forwarded by the Integrated BMC to the chipset. The BIOS does not affect the behavior of the reset button.

7.4.3 System Status Indicator LED

The Intel® Server Board S1200BTL has a system status indicator LED on the front panel. This indicator LED has specific states and corresponding interpretation as shown in the following table.

Table 27. System Status LED Indicator States

Color	State	Criticality	Description
Green	Solid on	Ok	System booted and ready
Green	~1 Hz blink	Degraded	System degraded: Non-critical temperature threshold asserted. Non-critical voltage threshold asserted. Non-critical fan threshold asserted. Fan redundancy lost, sufficient system cooling maintained. This does not apply to non-redundant systems. Power supply predictive failure. Power supply redundancy lost. This does not apply to non-redundant systems. Correctable errors over a threshold of 10 and migrating to a spare DIMM (memory sparing). This indicates the user no longer has spared DIMMs indicating a redundancy lost condition. Corresponding DIMM LED should light up 4.
Amber	~1 Hz blink	Non-critical	Non-fatal alarm – system is likely to fail: CATERR asserted. Critical temperature threshold asserted. Critical voltage threshold asserted. Critical fan threshold asserted. VRD hot asserted. SMI Timeout asserted.
Amber	Solid on	Critical, non-recoverable	Fatal alarm – system has failed or shutdown: Thermtrip asserted. Non-recoverable temperature threshold asserted. Non-recoverable voltage threshold asserted. Power fault/Power Control Failure. Fan redundancy lost, insufficient system cooling. This does not apply to non-redundant systems.
Off	N/A	Not ready	AC power off, if no degraded, non-critical, critical, or non-recoverable conditions exist.

Notes:

1. The BIOS detects these conditions and sends a Set Fault Indication command to the Integrated BMC to provide the contribution to the system status LED.
2. Support for upper non-critical limit is not provided in the default SDR configuration. However, if a user does enable this threshold in the SDR, then the system status LED should behave as described.

There is no precedence or lock-out mechanism for the control sources. When a new request arrives, all previous requests are terminated. For example, if the chassis ID LED is blinking and the chassis ID button is pressed, then the chassis ID LED changes to solid on. If the button is pressed again with no intervening commands, the chassis ID LED turns off.

7.5 I/O Connectors

7.5.1 VGA Connector

The following table details the pin-out definition of the VGA connector (J7A1 on S1200BTL and J6A1 on S1200BTS):

Table 28. VGA Connector Pin-out

Pin	Signal Name	Description
1	V_IO_R_CONN	Red (analog color signal R)
2	V_IO_G_CONN	Green (analog color signal G)
3	V_IO_B_CONN	Blue (analog color signal B)
4	TP_VID_CONN_B4	No connection
5	GND	Ground
6	GND	Ground
7	GND	Ground
8	GND	Ground
9	TP_VID_CONN_B9	No connection
10	GND	Ground
11	TP_VID_CONN_B11	No connection
12	V_IO_DDCDAT	DDCDAT
13	V_IO_HSYNC_CONN	HSYNC (horizontal sync)
14	V_IO_VSYNC_CONN	VSYNC (vertical sync)
15	V_IO_DDCCLK	DDCCLK

7.5.2 Rear NIC and USB connector

The server board provides two stacked RJ-45/2xUSB connectors side-by-side on the back edge of the board. The pin-out for NIC connectors is identical and defined in the following table:

Table 29. RJ-45 10/100/1000 NIC Connector Pin-out

Pin	Signal Name	Pin	Signal Name
1	P5V_USB_PWR75	2	USB_PCH_11_FB_DN
3	USB_PCH_11_FB_DP	4	GND
5	P5V_USB_PWR75	6	USB_PCH_10_FB_DN
7	USB_PCH_10_FB_DP	8	GND
9	P1V9_LAN2_R	10	NIC2_MDIP<0>
11	NIC2_MDIN<0>	12	NIC2_MDIP<1>
13	NIC2_MDIN<1>	14	NIC2_MDIP<2>
15	NIC2_MDIN<2>	16	NIC2_MDIP<3>
17	NIC2_MDIN<3>	18	GND
19	LED_NIC2_1	20	P3V3_AUX
21	LED_NIC2_LINK100_R_0	22	LED_NIC2_LINK1000_2

Table 30. RJ-45 10/100/1000 NIC Connector Pin-out (J6A1)

Pin	Signal Name	Pin	Signal Name
1	P5V_USB_PWR75	2	USB_PCH_11_FB_DN
3	USB_PCH_11_FB_DP	4	GND
5	P5V_USB_PWR75	6	USB_PCH_10_FB_DN
7	USB_PCH_10_FB_DP	8	GND
9	P1V8_PHY_VCT_R	10	NIC1_MDIP<0>
11	NIC1_MDIN<0>	12	NIC1_MDIP<1>
13	NIC1_MDIN<1>	14	NIC2_MDIP<2>
15	NIC1_MDIN<2>	16	NIC2_MDIP<3>
17	NIC1_MDIN<3>	18	GND
19	LED_NIC1_LINK_ACT_0_R	20	P3V3_AUX
21	LED_NIC1_2	22	LED_NIC1_LINK1000_1

7.5.3 SATA

The server board provides up to two 6Gb/s SATA connectors and four 3Gb/s SATA connectors. The pin configuration for each connector is identical and defined in the following table:

Table 31. 6Gb/s SATA Connector Pin-Out

Pin	Signal Name
1	GND
2	SATA_TX_P
3	SATA_TX_N
4	GND
5	SATA_RX_N
6	SATA_RX_P
7	GND

Table 32. 3Gb/s SATA Connector Pin-out

Pin	Signal Name	Description
1	GND	Ground
2	SATA/SAS_TX_P_C	Positive side of transmit differential pair
3	SATA/SAS_TX_N_C	Negative side of transmit differential pair
4	GND	Ground
5	SATA/SAS_RX_N_C	Negative side of receive differential pair
6	SATA/SAS_RX_P_C	Positive side of receive differential pair
7	GND	Ground

7.5.4 SAS Connectors

The Intel® Server Board S1200BTL provides one SAS connector.

The pin configuration is identical and defined in the following table:

Table 33. SAS Connector Pin-out (J2H1)

Pin	Signal Name	Description
1	GND	Ground
2	SATA/SAS_TX_P_C	Positive side of transmit differential pair
3	SATA/SAS_TX_N_C	Negative side of transmit differential pair
4	GND	Ground
5	SATA/SAS_RX_N_C	Negative side of receive differential pair
6	SATA/SAS_RX_P_C	Positive side of receive differential pair
7	GND	Ground

7.5.5 Serial Port Connectors

The server board provides one external DB9 Serial A port (J8A1) and one internal 9-pin serial B header (J1B2). The following tables define the pin-outs.

Table 34. External Serial A Port Pin-out (J8A1)

Pin	Signal Name	Description
1	SPA_DCD	DCD (carrier detect)
2	SPA_SIN_L	RXD (receive data)
3	SPA_SOUT_N	TXD (Transmit data)
4	SPA_DTR	DTR (Data terminal ready)
5	GND	Ground
6	SPA_DSR	DSR (data set ready)
7	SPA_RTS	RTS (request to send)
8	SPA_CTS	CTS (clear to send)
9	SPA_RI	RI (Ring Indicate)
10	NC	

Table 35. Internal 9-pin Serial B Header Pin-out (J1B2)

Pin	Signal Name	Description
1	SPB_DCD	DCD (carrier detect)
2	SPB_DSR	DSR (data set ready)
3	SPB_SIN_L	RXD (receive data)
4	SPB_RTS	RTS (request to send)
5	SPB_SOUT_N	TXD (Transmit data)
6	SPB_CTS	CTS (clear to send)
7	SPB_DTR	DTR (Data terminal ready)
8	SPB_RI	RI (Ring indicate)
9	SPB_EN_N	Enable
10	NC	

7.5.6 USB Connector

There are four external USB ports on two NIC/USB combinations. Section 5.5.2 details the pin-out of the connector.

Two 2x5 connector on the server board (J1D1, J1E1) provides an option to support an additional USB port, each connector supporting two USB ports. The following table defines the pin-out of the connector.

Table 36. Internal USB Connector Pin-out (J1E1, J1D1)

Pin	Signal Name	Description
1	USB2_VBUS4	USB power (port 4)
2	USB2_VBUS5	USB power (port 5)
3	USB_ICH_P4N_CONN	USB port 4 negative signal
4	USB_ICH_P5N_CONN	USB port 5 negative signal
5	USB_ICH_P4P_CONN	USB port 4 positive signal
6	USB_ICH_P5P_CONN	USB port 5 positive signal
7	Ground	
8	Ground	
9	Key	No pin
10	TP_USB_ICH_NC	Test point

One 2x5 connectors on the server board provides an option to support Smart module. The following table defines the pin-out of the connector:

Table 37. Pin-out of Internal USB Connector for low-profile Smart module (J3F2)

Pin	Signal Name	Description
1	+5V	USB power
2	NC	N/A
3	USB Data -	USB port ## negative signal
4	NC	N/A
5	USB Data +	USB port ## positive signal
6	NC	N/A
7	Ground	N/A
8	NC	N/A
9	Key	No pin
10	LED#	Activity LED

7.6 PCI Express* Slot/PCI Slot/Riser Card Slot

A PCI-E Riser card will enable a PCI-E add-on card to be accommodated in the 1U chassis. The following table shows the pin-out for this riser slot.

Table 38. Pin-out of adaptive riser slot/PCI Express slot 6

Pin	Signal	Description	Pin	Signal	Description
B1	+12V	P12V	A1	PRSNT1_N	GND
B2	+12V	P12V	A2	+12V	P12V
B3	RSVD	P12V	A3	+12V	P12V
B4	GND	GND	A4	GND	GND
B5	SMCLK	PU_S6_SMBCLK	A5	JTAG2	P3V3_RISER_A5
B6	SMDATA	PU_S6_SMBDAT	A6	JTAG3	JTAG_S6_TDI
B7	GND	GND	A7	JTAG4	NC
B8	+3.3V	P3V3	A8	JTAG5	P3V3_RISER_A8
B9	JTAG1	JTAG_S6_TRST_N	A9	+3_3V	P3V3
B10	+3.3VAUX	P3V3_AUX	A10	+3_3V	P3V3
B11	WAKE_N	FM_PE_WAKE_N	A11	PERST_N	RST_PE_S236_N_R1
KEY			KEY		
KEY			KEY		
B12	RSVD	NC	A12	GND	GND
B13	GND	GND	A13	REFCLKP	CLK_100M_SLOT6A_DP
B14	PETP0	P2E_CPU_C_S6_TXP<7>	A14	REFCLKN	CLK_100M_SLOT6A_DPN
B15	PETN0	P2E_CPU_C_S6_TXN<7>	A15	GND	GND
B16	GND	GND	A16	PERP0	P2E_CPU_S6_RXP<7>
B17	PRSNT2_N	NC	A17	PERN0	P2E_CPU_S6_RXN<7>
B18	GND	GND	A18	GND	GND
B19	PETP1	P2E_CPU_C_S6_TXP<6>	A19	RSVD	NC
B20	PETN1	P2E_CPU_C_S6_TXN<6>	A20	GND	GND
B21	GND	GND	A21	PERP1	P2E_CPU_S6_RXP<6>
B22	GND	GND	A22	PERN1	P2E_CPU_S6_RXN<6>
B23	PETP2	P2E_CPU_C_S6_TXP<5>	A23	GND	GND
B24	PETN2	P2E_CPU_C_S6_TXN<5>	A24	GND	GND
B25	GND	GND	A25	PERP2	P2E_CPU_S6_RXP<5>
B26	GND	GND	A26	PERN2	P2E_CPU_S6_RXN<5>
B27	PETP3	P2E_CPU_C_S6_TXP<4>	A27	GND	GND
B28	PETN3	P2E_CPU_C_S6_TXN<4>	A28	GND	GND
B29	GND	GND	A29	PERP3	P2E_CPU_S6_RXP<4>
B30	RSVD	NC	A30	PERN3	P2E_CPU_S6_RXN<4>
B31	PRSNT2_N	NC	A31	GND	GND
B32	GND	GND	A32	RSVD	NC
End of x4			End of x4		
B33	PETP4	P2E_CPU_C_S6_TXP<3>	A33	RSVD	NC
B34	PETN4	P2E_CPU_C_S6_TXN<3>	A34	GND	GND
B35	GND	GND	A35	PERP4	P2E_CPU_S6_RXN<3>
B36	GND	GND	A36	PERN4	P2E_CPU_S6_RXP<3>
B37	PETP5	P2E_CPU_C_S6_TXP<2>	A37	GND	GND
B38	PETN5	P2E_CPU_C_S6_TXN<2>	A38	GND	GND

Pin	Signal	Description	Pin	Signal	Description
B39	GND	GND	A39	PERP5	P2E_CPU_S6_RXN<2>
B40	GND	GND	A40	PERN5	P2E_CPU_S6_RXP<2>
B41	PETP6	P2E_CPU_C_S6_TXP<1>	A41	GND	GND
B42	PETN6	P2E_CPU_C_S6_TXN<1>	A42	GND	GND
B43	GND	GND	A43	PERP6	P2E_CPU_S6_RXN<1>
B44	GND	GND	A44	PERN6	P2E_CPU_S6_RXP<1>
B45	PETP7	P2E_CPU_C_S6_TXP<0>	A45	GND	GND
B46	PETN7	P2E_CPU_C_S6_TXN<0>	A46	GND	GND
B47	GND	GND	A47	PERP7	P2E_CPU_S6_RXN<0>
B48	PRSNT2_N	NC	A48	PERN7	P2E_CPU_S6_RXP<0>
B49	GND	GND	A49	GND	GND
End of x8			End of x8		
B50	PETP8	NC	A50	RSVD	NC
B51	PETN8	NC	A51	GND	GND
B52	GND	GND	A52	PERP8	NC
B53	GND	GND	A53	PERN8	NC
B54	PETP9	NC	A54	GND	GND
B55	PETN9	NC	A55	GND	GND
B56	GND	GND	A56	PERP9	NC
B57	GND	GND	A57	PERN9	NC
B58	PETP10	NC	A58	GND	GND
B59	PETN10	NC	A59	GND	GND
B60	GND	GND	A60	PERP10	NC
B61	GND	GND	A61	PERN10	NC
B62	PEXP11	NC	A62	GND	GND
B63	PETN11	NC	A63	GND	GND
B64	GND	GND	A64	PERP11	NC
B65	GND	GND	A65	PERN11	NC
B66	PETP12	NC	A66	GND	GND
B67	PETN12	NC	A67	GND	GND
B68	GND	GND	A68	PERP12	NC
B69	GND	GND	A69	PERN12	NC
B70	PETP13	NC	A70	GND	GND
B71	PETN13	NC	A71	GND	GND
B72	GND	GND	A72	PERP13	NC
B73	GND	GND	A73	PERN13	NC
B74	PETP14	NC	A74	GND	GND
B75	PETN14	NC	A75	GND	GND
B76	GND	GND	A76	PERP14	NC
B77	GND	GND	A77	PERN14	NC
B78	PETP15	NC	A78	GND	GND
B79	PETN15	NC	A79	GND	GND
B80	GND	GND	A80	PERP15	NC
B81	PRSNT2_N	NC	A81	PERN15	NC
B82	RSVD	NC	A82	GND	GND

Table 39. Three PCI Express* x8 connectors (J2B2, J3B1 and J4B2)

Pin	Signal	Pin	Signal	Pin	Signal	Pin	Signal
A1	PRSNT1#	B1	+12V	A26	HSIP[2]	B26	GND
A2	+12V	B2	+12V	A27	GND	B27	HSOP[3]
A3	+12V	B3	RESERVED	A28	GND	B28	HSOP[3]
A4	GND	B4	GND	A29	HSIP[3]	B29	GND
A5	JTAG2/TCk	B5	SMCLK	A30	HSIN[3]	B30	RESERVED
A6	JTAG3/TDI	B6	SMDAT	A31	GND	B31	PRSNT2#
A7	JTAG4/TDO	B7	GND	A32	RESERVED	B32	GND
A8	JTAG5/TMS	B8	+3.3V	A33	RESERVED	B33	HSOP[4]
A9	+3.3V	B9	JTAG1/TRST#	A34	GND	B34	HSOP[4]
A10	+3.3V	B10	3.3VAUX	A35	HSIP[4]	B35	GND
A11	PERST#	B11	WAKE#	A36	HSIN[4]	B36	GND
A12	GND	B12	RESERVED	A37	GND	B37	HSOP[5]
A13	REFCLK+	B13	GND	A38	GND	B38	HSOP[5]
A14	REFCLK-	B14	HSOP[0]	A39	HSIP[5]	B39	GND
A15	GND	B15	HSOP[0]	A40	HSIN[5]	B40	GND
A16	HSIP[0]	B16	GND	A41	GND	B41	HSOP[6]
A17	HSIN[0]	B17	PRSNT2#	A42	GND	B42	HSOP[6]
A18	GND	B18	GND	A43	HSIP[6]	B43	GND
A19	RESERVED	B19	HSOP[1]	A44	HSIN[6]	B44	GND
A20	GND	B20	HSOP[1]	A45	GND	B45	HSOP[7]
A21	HSIP[1]	B21	GND	A46	GND	B46	HSOP[7]
A22	HSIN[1]	B22	GND	A47	HSIP[7]	B47	GND
A23	GND	B23	HSOP[2]	A48	HSIN[7]	B48	PRSNT2#
A24	GND	B24	HSOP[2]	A49	GND	B49	GND
A25	HSIP[2]	B25	GND				

Table 40. One PCI X32 connector (J1B1)

Pin #	Signal	Pin #	Signal	Pin #	Signal	Pin #	Signal
B1	-12V	A1	TRST#	B32	AD[17]	A32	AD[16]
B2	TCK	A2	+12V	B33	C/BE[2]#	A33	+3.3V
B3	Ground	A3	TMS	B34	Ground	A34	FRAME#
B4	TDO	A4	TDI	B35	IRDY#	A35	Ground
B5	+5V	A5	+5V	B36	+3.3V	A36	TRDY#
B6	+5V	A6	INTA#	B37	DEVSEL#	A37	Ground
B7	INTB#	A7	INTC#	B38	Ground	A38	STOP#
B8	INTD#	A8	+5V	B39	LOCK#	A39	+3.3V
B9	PRSNT1#	A9	RSVD	B40	PERR#	A40	RSVD
B10	RSVD	A10	V_IO	B41	+3.3V	A41	RSVD
B11	PRSNT2#	A11	RSVD	B42	SERR#	A42	Ground
B12	GND	A12	GND	B43	+3.3V	A43	PAR
B13	GND	A13	GND	B44	C/BE[1]#	A44	AD[15]
B14	RSVD	A14	3.3Vaux	B45	AD[14]	A45	+3.3V
B15	Ground	A15	RST#	B46	Ground	A46	AD[13]
B16	CLK	A16	V_IO	B47	AD[12]	A47	AD[11]
B17	Ground	A17	GNT#	B48	AD[10]	A48	Ground

Pin #	Signal	Pin #	Signal	Pin #	Signal	Pin #	Signal
B18	REQ#	A18	Ground	B49	M66EN	A49	AD[09]
B19	V_IO	A19	PME#	B50	KEY	A50	KEY
B20	AD[31]	A20	AD[30]	B51	KEY	A51	KEY
B21	AD[29]	A21	+3.3V	B52	AD[08]	A52	C/BE[0]#
B22	Ground	A22	AD[28]	B53	AD[07]	A53	+3.3V
B23	AD[27]	A23	AD[26]	B54	+3.3V	A54	AD[06]
B24	AD[25]	A24	Ground	B55	AD[05]	A55	AD[04]
B25	+3.3V	A25	AD[24]	B56	AD[03]	A56	Ground
B26	C/BE[3]#	A26	IDSEL	B57	Ground	A57	AD[02]
B27	AD[23]	A27	+3.3V	B58	AD[01]	A58	AD[00]
B28	Ground	A28	AD[22]	B59	V_IO	A59	V_IO
B29	AD[21]	A29	AD[20]	B60	ACK64#	A60	REQ64#
B30	AD[19]	A30	Ground	B61	+5V	A61	+5V
B31	+3.3V	A31	AD[18]	B62	+5V	A62	+5V

7.7 Fan Headers

The server board provides five SSI-compliant 4-pin fan headers to be used as the CPU and chassis. The pin configuration for each of the 4-pin fan headers is identical and defined in the following table:

- One 4-pin fan headers are designated as processor cooling fans:
 - CPU fan (J5J1 on S1200BTL and J4J1 on S1200BTS)
 - SYS1 fan (J1J4 on S1200BTL and J7J1 on S1200BTS)
 - SYS2 fan (J5J2 on S1200BTL and J7B1 on S1200BTS)
 - SYS3 fan (J7J1 on S1200BTL and J2J1 on S1200BTS)
 - SYS4 fan (J7B1 for S1200BTL)

Table 41. SSI 4-pin Fan Header Pin-out

Pin	Signal Name	Type	Description
1	Ground	GND	Ground is the power supply ground
2	12 V	Power	Power supply 12 V
3	Fan Tach	In	FAN_TACH signal is connected to the Integrated BMC to monitor the fan speed
4	Fan PWM	Out	FAN_PWM signal to control fan speed

8. Jumper Blocks

The server board has several 3-pin jumper blocks that can be used to configure, protect or recover specific features of the server board.

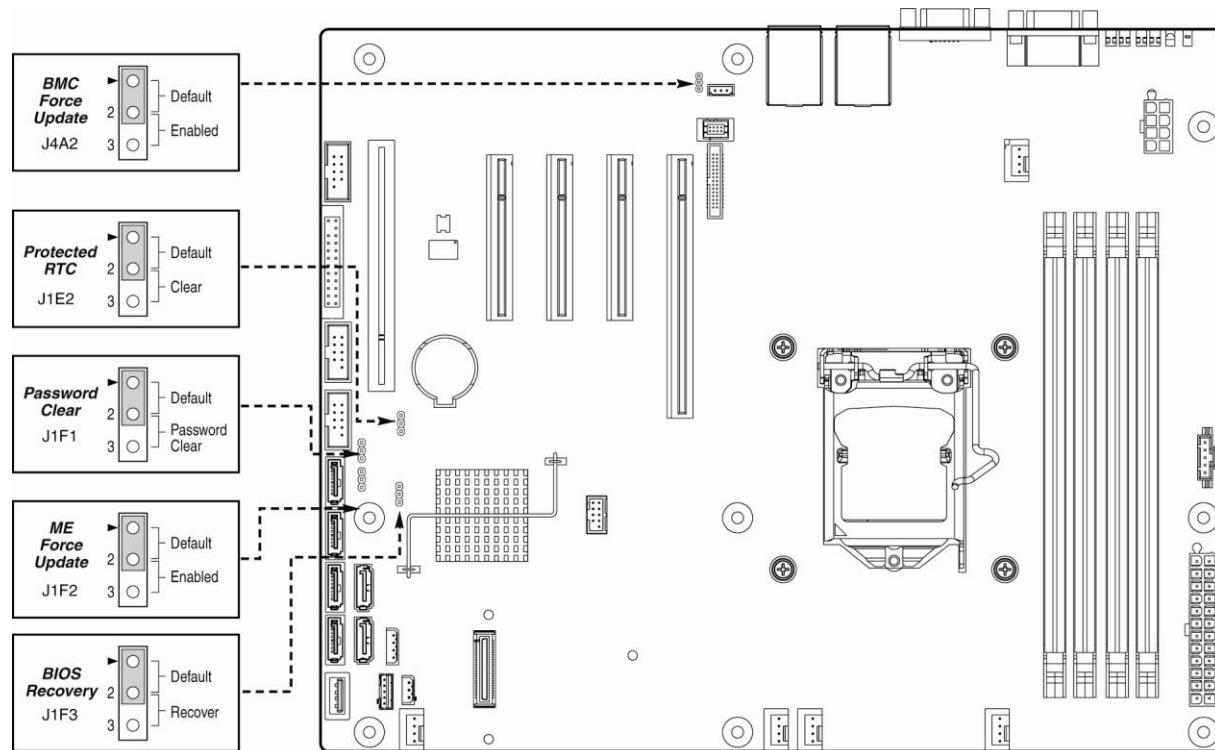

AF003510

Figure 46. Jumper Blocks (J4A2, J1F1, J1F3, J1F2, and J1E2) on S1200BTL

Table 42. Server Board Jumpers (J1F1, J1F2, J1F3, J1E2, and J4A2) on S1200BTL

Jumper Name	Pins	System Results
J1E2: CMOS Clear	1-2	These pins should have a jumper in place for normal system operation. (Default)
	2-3	If these pins are jumpered with AC power plugged, the CMOS settings are cleared within five seconds. These pins should not be jumpered for normal operation.
J1F2: ME Force Update	1-2	ME Firmware Force Update Mode – Disabled (Default)
	2-3	ME Firmware Force Update Mode – Enabled
J1F1: Password Clear	1-2	These pins should have a jumper in place for normal system operation. (Default)
	2-3	If these pins are jumpered, administrator and user passwords are cleared within 5-10 seconds after the system is powered on. These pins should not be jumpered for normal operation.
J1F3: BIOS Recovery	1-2	These pins should have a jumper in place for normal system operation. (Default)
	2-3	Given that the main system BIOS will not boot with these pins jumpered, system can only boot from EFI-bootable recovery media with the recovery BIOS image.
J4A2: BMC Force Update	1-2	Integrated BMC Firmware Force Update Mode – Disabled (Default)
	2-3	Integrated BMC Firmware Force Update Mode – Enabled

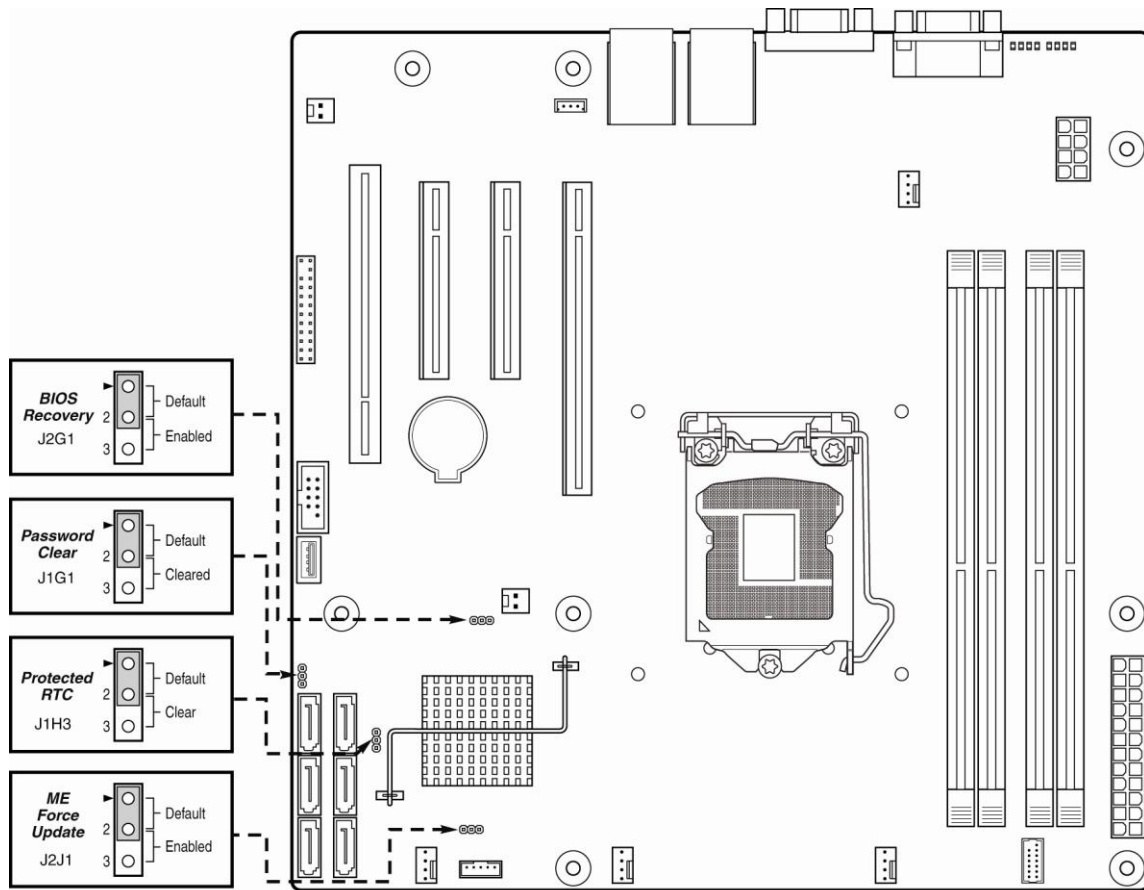

AF003618

Figure 47. Jumper Blocks (J2G1, J1G1, J1H3, and J2J1) on S1200BTS

Table 43. Server Board Jumpers (J2G1, J1G1, J1H3, and J2J1) on S1200BTS

Jumper Name	Pins	System Results
J1H3: CMOS Clear	1-2	These pins should have a jumper in place for normal system operation. (Default)
	2-3	If these pins are jumpered with AC power plugged, the CMOS settings are cleared within five seconds. These pins should not be jumpered for normal operation.
J1J2: ME Force Update	1-2	ME Firmware Force Update Mode – Disabled (Default)
	2-3	ME Firmware Force Update Mode – Enabled
J1G1: Password Clear	1-2	These pins should have a jumper in place for normal system operation. (Default)
	2-3	If these pins are jumpered, administrator and user passwords are cleared within 5-10 seconds after the system is powered on. These pins should not be jumpered for normal operation.
J2G1: BIOS Recovery	1-2	These pins should have a jumper in place for normal system operation. (Default)
	2-3	Given that the main system BIOS will not boot with these pins jumpered, system can only boot from EFI-bootable recovery media with the recovery BIOS image.

8.1 CMOS Clear and Password Reset Usage Procedure

The CMOS Clear and Password Reset recovery features are designed such that the desired operation can be achieved with minimal system downtime. The usage procedure for these two

features has changed from previous generation Intel® server boards. The following procedure outlines the new usage model.

8.1.1 Clearing the CMOS

To clear the CMOS, perform the following steps:

1. Power down the server. Do not unplug the power cord.
2. Open the server chassis. For instructions, see your server chassis documentation.
3. Move jumper from the default operating position (covering pins 1 and 2) to the reset/clear position (covering pins 2 and 3).
4. Wait five seconds.
5. Remove AC power.
6. Move the jumper back to the default position (covering pins 1 and 2).
7. Close the server chassis.
8. Power up the server.

The CMOS is now cleared and can be reset by going into the BIOS setup.

Note: Removing AC power before performing the CMOS clear operation causes the system to automatically power up and immediately power down, after the procedure is followed and AC power is re-applied. If this happens, remove the AC power cord again, wait 30 seconds, and re-install the AC power cord. Power up the system and proceed to the <F2> BIOS Setup utility to reset the preferred settings.

8.1.2 Clearing the Password

To clear the password, perform the following steps:

1. Power down the server. Do not unplug the power cord.
2. Open the chassis. For instructions, see your server chassis documentation.
3. Move jumper from the default operating position (covering pins 1 and 2) to the password clear position (covering pins 2 and 3).
4. Close the server chassis.
5. Power up the server and wait 10 seconds or until POST completes.
6. Power down the server.
7. Open the chassis and move the jumper back to the default position (covering pins 1 and 2).
8. Close the server chassis.
9. Power up the server.

The password is now cleared and can be reset by going into the BIOS setup.

8.2 Integrated BMC Force Update Procedure (Only for The Intel® Server Board S1200BTL)

When performing the standard Integrated BMC firmware update procedure, the update utility places the Integrated BMC into an update mode, allowing the firmware to load safely onto the flash device. In the unlikely event the Integrated BMC firmware update process fails due to the Integrated BMC not being in the proper update state, the server board provides an Integrated BMC Force Update jumper (J4A2), which forces the Integrated BMC into the proper update state. The following procedure should be completed in the event the standard Integrated BMC firmware update process fails.

1. Power down and remove the AC power cord.
2. Open the server chassis. For instructions, see your server chassis documentation.
3. Move jumper from the default operating position (covering pins 1 and 2) to the enabled position (covering pins 2 and 3).
4. Close the server chassis.
5. Reconnect the AC cord and power up the server.
6. Perform the Integrated BMC firmware update procedure as documented in the README.TXT file that is included in the given Integrated BMC firmware update package. After successful completion of the firmware update process, the firmware update utility may generate an error stating that the Integrated BMC is still in update mode.
7. Power down and remove the AC power cord.
8. Open the server chassis.
9. Move jumper from the enabled position (covering pins 2 and 3) to the disabled position (covering pins 1 and 2).
10. Close the server chassis.
11. Reconnect the AC cord and power up the server.

Note: Normal Integrated BMC functionality is disabled with the Force Integrated BMC Update jumper set to the enabled position. The server should never be run with the Integrated BMC Force Update jumper set in this position. This jumper setting should only be used when the standard firmware update process fails. This jumper should remain in the default/disabled position when the server is running normally.

8.3 ME Force Update Jumper

When performing the standard ME force update procedure, the update utility places the ME into an update mode, allowing the ME to load safely onto the flash device. In the unlikely event ME firmware update process fails due to ME not being in the proper update state, the server board provides an Integrated BMC Force Update jumper, which forces the ME into the proper update state. The following procedure should be completed in the event the standard ME firmware update process fails.

1. Power down and remove the AC power cord.

2. Open the server chassis. For instructions, see your server chassis documentation.
3. Move jumper from the default operating position (covering pins 1 and 2) to the enabled position (covering pins 2 and 3).
4. Close the server chassis.
5. Reconnect the AC cord and power up the server.
6. Perform the ME firmware update procedure as documented in the README.TXT file that is included in the given ME firmware update package (same package as BIOS).
7. Power down and remove the AC power cord.
8. Open the server chassis.
9. Move jumper from the enabled position (covering pins 2 and 3) to the disabled position (covering pins 1 and 2).
10. Close the server chassis.
11. Reconnect the AC cord and power up the server.

8.4 BIOS Recovery Jumper

The following procedure boots the recovery BIOS and flashes the normal BIOS:

1. Turn off the system power.
2. Move the BIOS recovery jumper to the recovery state.
3. Insert a bootable BIOS recovery media containing the new BIOS image files.
4. Turn on the system power.

The BIOS POST screen will appear displaying the progress, and the system will boot to the EFI shell. The EFI shell then executes the Startup.nsh batch file to start the flash update process. The user should then switch off the power and return the recovery jumper to its normal position. The user should not interrupt the BIOS POST on the first boot after recovery.

When the flash update completes:

1. Remove the recovery media .
2. Turn off the system power .
3. Restore the jumper to its original position.
4. Turn on the system power.
5. Re-flash any custom blocks, such as user binary or language blocks.

The system should now boot using the updated system BIOS.

9. Intel® Light Guided Diagnostics

The server board has several on-board diagnostic LEDs to assist in troubleshooting board-level issues. This section shows where each LED is located on the server board and describes the function of each LED.

9.1 System Status LED (Only for S1200BTL)

The server board provides a system status indicator LED on the front panel. This indicator LED has specific states and corresponding interpretation as shown in the following table:

Table 44. Front Panel LED Behavior Summary

LED	Color	Condition	Description
Power/Sleep	Green	On	Power on or S0 sleep
	Green	Blink	S1 sleep or S3 standby only for workstation baseboards
		Off	Off (also sleep S4/S5 modes)
Status	Green	On	System ready/No alarm
	Green	Blink	System ready, but degraded: redundancy lost such as PS or fan failure; non-critical temp/voltage threshold; battery failure; or predictive PS failure.
	Amber	On	Critical alarm: Voltage, thermal, or power fault; CPU missing; insufficient power unit redundancy resource offset asserted
	Amber	Blink	Non-Critical failure: Critical temp/voltage threshold; VDR hot asserted; min number fans not present or failed
		Off	AC power off: System unplugged AC power on: System powered off and in standby, no prior degraded\non-critical\critical state
Global HDD Activity	Green	Blink	HDD access
		Off	No access and no fault
LAN 1-2	Green	On	LAN link/ no access
	Green	Blink	LAN access
		Off	Idle
Chassis Identification	Blue	On	Front panel chassis ID button pressed
	Blue	Blink	Unit selected for identification via software
		Off	No identification

9.2 Post Code Diagnostic LEDs

During the system boot process, the BIOS executes several platform configuration processes, each of which is assigned a specific hex POST code number. As each configuration routine is started, the BIOS displays the POST code on the POST code diagnostic LEDs found on the back edge of the server board. To assist in troubleshooting a system hang during the POST process, the diagnostic LEDs can be used to identify the last POST process executed.

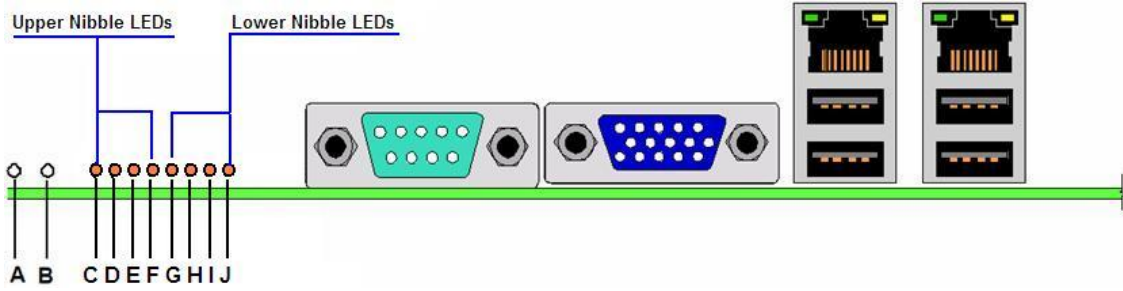

Figure 48. POST Code Diagnostic LED Location

A	Status LED	F	Diagnostic LED #4
B	ID LED	G	Diagnostic LED #3
C	Diagnostic LED #7 (MSB LED)	H	Diagnostic LED #2
D	Diagnostic LED #6	I	Diagnostic LED #1
E	Diagnostic LED #5	J	Diagnostic LED #0 (LSB LED)

10. Design and Environmental Specifications

10.1 Intel® Server Board S1200BT Design Specifications

The operation of the server board at conditions beyond those shown in the following table may cause permanent damage to the system. Exposure to absolute maximum rating conditions for extended periods may affect system reliability.

Table 45. Server Board Design Specifications

Operating Temperature	0° C to 55° C ¹ (32° F to 131° F)
Non-Operating Temperature	-40° C to 70° C (-40° F to 158° F)
DC Voltage	± 5% of all nominal voltages
Shock (Unpackaged)	Trapezoidal, 50 G, 170 inches/sec
Shock (Packaged)	
<20 pounds	36 inches
20 to <40 pounds	30 inches
40 to <80 pounds	24 inches
80 to <100 pounds	18 inches
100 to <120 pounds	12 inches
120 pounds	9 inches
Vibration (Unpackaged)	5 Hz to 500 Hz 3.13 g RMS random

¹ Chassis design must provide proper airflow to avoid exceeding the Intel® Xeon® processor maximum case temperature.

Disclaimer Note: Intel Corporation server boards contain a number of high-density VLSI and power delivery components that need adequate airflow to cool. Intel® ensures through its own chassis development and testing that when Intel® server building blocks are used together, the fully integrated system will meet the intended thermal requirements of these components. It is the responsibility of the system integrator who chooses not to use Intel® developed server building blocks to consult vendor datasheets and operating parameters to determine the amount of airflow required for their specific application and environmental conditions. Intel Corporation cannot be held responsible, if components fail or the server board does not operate correctly when used outside any of their published operating or non-operating limits.

10.2 Board-level Calculated MTBF

This section provides results of MTBF (Mean Time Between Failures) testing done by a third party testing facility. MTBF is a standard measure for the reliability and performance of the board under extreme working conditions. The MTBF was measured at 20000 hours at 35 degrees Celsius.

Please go to <http://www.intel.com/support/motherboards/server> to get the updated MTBF report for Intel® Server Board S1200BT family.

10.2.1 Processor Power Support

The server board supports the Thermal Design Power (TDP) guideline for Intel® Xeon® processor. The Flexible Motherboard Guidelines (FMB) was also followed to help determine the

suggested thermal and current design values for anticipating future processor needs. The following table provides maximum values for I_{CC}, TDP power and T_{CASE} for the Intel® Xeon® SandyBridge Series processor.

Table 46. Intel® Xeon® Processor TDP Guidelines

TDP Power	Maximum T _{CASE}	I _{CC} Maximum
95 W	67.0° C	150 A

10.3 Power Supply Output Requirements

This section is for reference purposes only. The intent is to provide guidance to system designers to determine a power supply for use with this server board. This section specifies the power supply requirements Intel® used to develop a power supply for the Intel® Server System R1304BTL SHBN.

The following tables define two power and current ratings for this 350-W power supply. The combined output power of all outputs should not exceed the rated output power. The power supply must meet both static and dynamic voltage regulation requirements for the minimum loading conditions.

Table 47. 350-W Load Ratings

Voltage	Minimum Continuous	Maximum Continuous	Peak
+3.3 V	0.2A	14 A	
+5 V	1.0 A	18A	
+12 V	1.5A	24 A	28A
-12 V	0A	0.3A	
+5 VSB	0.1 A	2.0 A	2.5 A

Notes:

1. Maximum continuous total DC output power should not exceed 350 W.
2. Peak total DC output power should not exceed 400 W.
3. Peak power and peak current loading should be supported for a minimum of 12 seconds.
4. Combined 3.3 V/5 V power should not exceed 100 W.

10.3.1 Grounding

The grounds of the power supply output connector pins provide the power return path. The output connector ground pins are connected to the safety ground (power supply enclosure). This grounding is designed to ensure passing the maximum allowed common mode noise levels.

The power supply is provided with a reliable protective earth ground. All secondary circuits are connected to protective earth ground. Resistance of the ground returns to chassis does not exceed 1.0 m. This path may be used to carry DC current.

10.3.2 Standby Outputs

The 5 VSB output is present when an AC input greater than the power supply turn on voltage is applied.

10.3.3 Remote Sense

The power supply has remote sense return (ReturnS) to regulate out ground drops for all output voltages: +3.3 V, +5 V, +12 V, -12 V, and 5 VSB. The power supply uses remote sense to regulate out drops in the system for the +3.3 V, +5 V, and 12 V outputs. The power supply must operate within specification over the full range of voltage drops from the power supply's output connector to the remote sense points.

10.3.4 Voltage Regulation

The power supply output voltages must stay within the following voltage limits when operating at steady state and dynamic loading conditions. These limits include the peak-peak ripple/noise. All outputs are measured with reference to the return remote sense signal (ReturnS).

Table 48. Voltage Regulation Limits

Parameter	Tolerance	Minimum	Normal	Maximum	Units
+ 3.3 V	- 5% / +5%	+3.14	+3.30	+3.46	Vrms
+ 5 V	- 5% / +5%	+4.75	+5.00	+5.25	Vrms
+ 12 V	- 5% / +5%	+11.40	+12.00	+12.60	Vrms
- 12 V	- 10% / +10%	-13.20	-12.00	-10.80	Vrms
+ 5 VSB	- 5% / +5%	+4.75	+5.00	+5.25	Vrms

10.3.5 Dynamic Loading

The output voltages remain within limits for the step loading and capacitive loading specified in the following table. The load transient repetition rate is tested between 50 Hz and 5 kHz at duty cycles ranging from 10%-90%. The load transient repetition rate is only a test specification. The step load may occur anywhere within the Min load to the Max load conditions.

Table 49. Transient Load Requirements

Output	Δ Step Load Size (See note 2)	Load Slew Rate	Test capacitive Load
+3.3 V	5.0 A	0.25 A/μsec	250 μF
+5 V	6.0 A	0.25 A/μsec	400 μF
12 V	11.0 A	0.25 A/μsec	500 μF

Output	Δ Step Load Size (See note 2)	Load Slew Rate	Test capacitive Load
+5 VSB	0.5 A	0.25 A/ μ sec	20 μ F

Note:

Step loads on each 12 V output may happen simultaneously and should be tested that way.

10.3.6 Capacitive Loading

The power supply is stable and meets all requirements with the following capacitive loading ranges.

Table 50. Capacitive Loading Conditions

Output	Minimum	Maximum	Units
+3.3 V	100	2200	μ F
+5 V	400	2200	μ F
+12 V	500	2200	μ F
-12 V	1	350	μ F
+5 VSB	20	350	μ F

10.3.7 Closed-loop Stability

The power supply is unconditionally stable under all line/load/transient load conditions including capacitive load ranges. A minimum of 45° phase margin and -10 dB-gain margin is required. The power supply manufacturer provides proof of the unit's closed-loop stability with local sensing through the submission of Bode plots. Closed-loop stability is ensured at the maximum and minimum loads as applicable.

10.3.8 Common Mode Noise

The Common Mode noise on any output does not exceed 350 mV pk-pk over the frequency band of 10 Hz to 20 MHz.

- The measurement is made across a 100 Ω resistor between each of the DC outputs, including ground, at the DC power connector and chassis ground (power subsystem enclosure).
- The test setup uses a FET probe such as Tektronix* model P6046 or equivalent.

10.3.9 Ripple/Noise

The maximum allowed ripple/noise output of the power supply is defined in the following table. This is measured over a bandwidth of 0 Hz to 20 MHz at the power supply output connectors. A 10 F tantalum capacitor is placed in parallel with a 0.1 F ceramic capacitor at the point of measurement.

Table 51. Ripple and Noise

+3.3 V	+5 V	+12 V	-12 V	+5 VSB
50 mVp-p	50 mVp-p	120 mVp-p	120 mVp-p	50 mVp-p

10.3.10 Timing Requirements

The timing requirements for the power supply operation are as follows:

- The output voltages must rise from 10% to within regulation limits (T_{vout_rise}) within 5 ms to 70 ms, except for 5 VSB, in which case it is allowed to rise from 1.0 ms to 25 ms.
- The +3.3 V, +5 V, and +12 V output voltages should start to rise approximately at the same time.
- All outputs must rise monotonically.
- The +5 V output must be greater than the +3.3 V output during any point of the voltage rise.
- The +5 V output must never be greater than the +3.3 V output by more than 2.25 V.
- Each output voltage should reach regulation within 50 ms (T_{vout_on}) of each other when the power supply is turned on.
- Each output voltage should fall out of regulation within 400 msec (T_{vout_off}) of each other when the power supply is turned off.

Figure 49 and Figure 50 shows the timing requirements for the power supply being turned on and off via the AC input with PSON held low and the PSON signal with the AC input applied.

Table 52. Output Voltage Timing

Item	Description	Minimum	Maximum	Units
T_{vout_rise}	Output voltage rise time from each main output.	5.01	701	Msec
T_{vout_on}	All main outputs must be within regulation of each other within this time.		50	Msec
T_{vout_off}	All main outputs must leave regulation within this time.		700	Msec

Note:

1. The 5 VSB output voltage rise time should be from 1.0 ms to 25.0 ms.

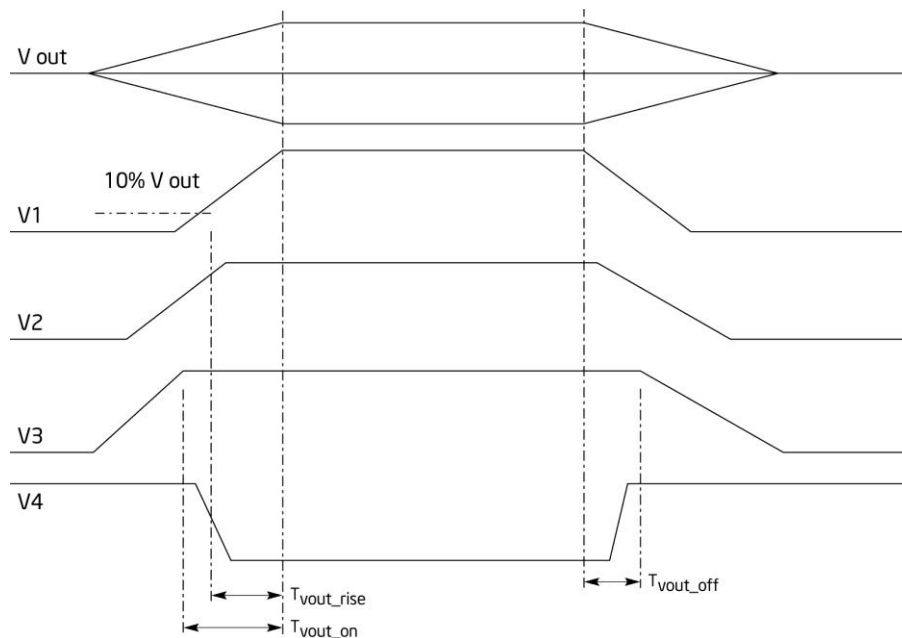

AF002709

Figure 49. Output Voltage Timing

Table 53. Turn On/Off Timing

Item	Description	Minimum	Maximum	Units
$T_{sb_on_delay}$	Delay from AC being applied to 5 VSB being within regulation.	N/A	1500	Msec
$T_{ac_on_delay}$	Delay from AC being applied to all output voltages being within regulation.	N/A	2500	Msec
T_{vout_holdup}	Duration for which all output voltages stay within regulation after loss of AC. Measured at 80% of maximum load.	21	N/A	Msec
T_{pwok_holdup}	Delay from loss of AC to de-assertion of PWOK. Measured at 80% of maximum load.	20	N/A	Msec
$T_{pson_on_delay}$	Delay from PSON# active to output voltages within regulation limits.	5	400	Msec
T_{pson_pwok}	Delay from PSON# deactive to PWOK being de-asserted.	N/A	50	Msec
T_{pwok_on}	Delay from output voltages within regulation limits to PWOK asserted at turn on.	100	500	Msec
T_{pwok_off}	Delay from PWOK de-asserted to output voltages (3.3 V, 5 V, 12 V, -12 V) dropping out of regulation limits.	1	N/A	Msec
T_{pwok_low}	Duration of PWOK being in the de-asserted state during an off/on cycle using AC or the PSON signal.	100	N/A	Msec
T_{sb_vout}	Delay from 5 VSB being in regulation to O/Ps being in regulation at AC turn on.	50	1000	Msec
T_{5VSB_holdup}	Duration for which the 5 VSB output voltage stays within regulation after loss of AC.	70	N/A	Msec

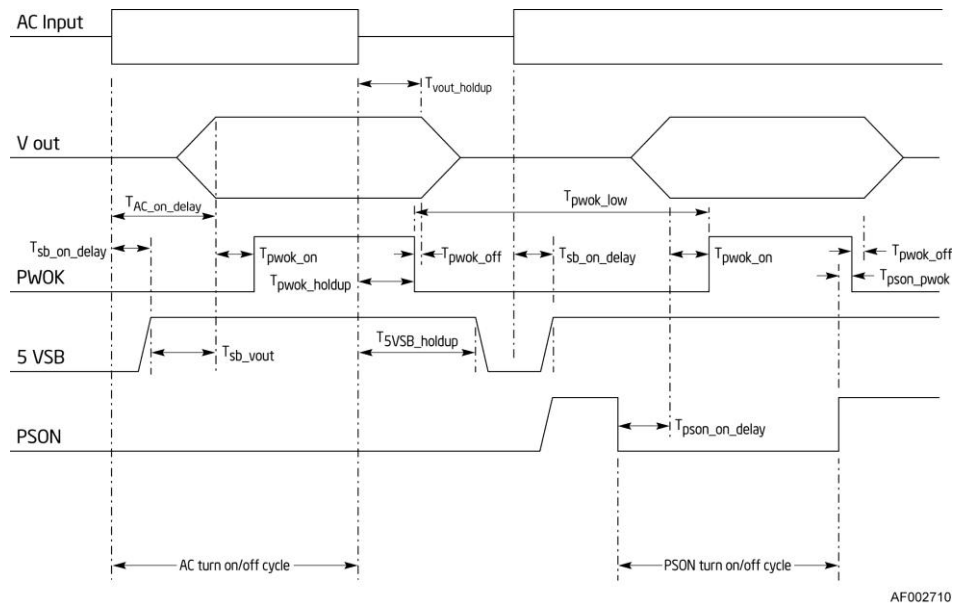

AF002710

Figure 50. Turn On/Off Timing (Power Supply Signals)

10.3.11 Residual Voltage Immunity in Standby Mode

The power supply is immune to any residual voltage placed on its outputs (typically, a leakage voltage through the system from standby output) up to 500 mV. There is no additional heat generated nor stressing of any internal components with this voltage applied to any individual output and all outputs simultaneously. It also does not trip the power supply protection circuits during turn on.

The residual voltage at the power supply outputs for a no-load condition does not exceed 100 mV when AC voltage is applied and the PSON# signal is de-asserted.

10.3.12 Protection Circuits

Protection circuits inside the power supply should cause only the power supply's main outputs to shut down. If the power supply latches off due to a protection circuit tripping, an AC cycle OFF for 15 seconds and a PSON# cycle HIGH for 1 second should reset the power supply.

10.3.12.1 Over-current Protection (OCP)

The power supply has current limits to prevent the +3.3 V, +5 V, and +12 V outputs from exceeding the values shown in the following table. If the current limits are exceeded, the power supply shuts down and latches off. The latch is cleared by toggling the PSON# signal or using an AC power interruption. The power supply is not damaged from repeated power cycling in this condition. -12 V and 5 VSB are protected under over-current or shorted conditions so no damage can occur to the power supply. Auto-recovery feature is a requirement on 5 VSB rail.

Table 54. Over-Current Protection (OCP)

VOLTAGE	OVER CURRENT LIMIT	
	Min	Max
+3.3V	15A	21A
+5V	20A	27A
+12V	30A	40A
-12V	0.625A	2A
5VSB	N/A	4A

10.3.12.2 Over-Voltage Protection (OVP)

The power supply over-voltage protection is locally sensed. The power supply shuts down and latches off after an over-voltage condition occurs. You can clear this latch by toggling the PSON# signal or using an AC power interruption. The following table contains the over-voltage limits. The values are measured at the output of the power supply's connectors. The voltage never exceeds the maximum levels when measured at the power pins of the power supply connector during any single point of fail. The voltage never trips any lower than the minimum levels when measured at the power pins of the power supply connector.

Exception: +5 VSB rail should be able to recover after an over-voltage condition occurs.

Table 55. Over-voltage Protection (OVP) Limits

Output Voltage	Minimum (V)	Maximum (V)
+3.3 V	3.9	4.5
+5 V	5.7	6.2
+12 V	13.3	14.5

Output Voltage	Minimum (V)	Maximum (V)
-12 V	-13.3	-14.5
+5 VSB	5.7	6.5

Appendix A: Integration and Usage Tips

- When adding or removing components or peripherals from the server board, AC power must be removed. With AC power plugged into the server board, 5-Volt standby is still present even though the server board is powered off.
- When updating BIOS and BMC, AC power must be on.
- Supports only Intel® Xeon® Processor E3-1200 Series with 95 W or Intel® Core™ Processor i3-2100 and less Thermal Design Power (TDP). Does not support previous generations of the Intel® Xeon® processor.
- On the back edge of the server board are diagnostic LEDs that display a sequence of amber POST codes during the boot process. If the server board hangs during POST, the LEDs display the last POST event run before the hang.
- Supports only unbuffered DDR3 DIMMs (UDIMMs). Does not support the mixing of RDIMMs and UDIMMs.
- The Intel® Remote Management Module 4 (Intel® RMM4) lite connector is not compatible with the Intel® Remote Management Module (Product Order Code - AXXRMM), Intel® Remote Management Module 2 (Product Order Code - AXXRMM2) or Intel® Remote Management Module 3 (Product Order Code – AXXRMM3)
- Clear the CMOS with the AC power cord plugged in. Removing the AC power before performing the CMOS clear operation causes the system to automatically power up and immediately power down after the CMOS clear procedure is followed and AC power is re-applied. If this happens, remove the AC power cord, wait 30 seconds, and then re-connect the AC power cord. Power up the system and proceed to the <F2> BIOS Setup utility to reset the needed settings.
- Normal Integrated BMC functionality is disabled with the force Integrated BMC update jumper set to the “enabled” position (pins 2-3). The server should never be run with the Integrated BMC force update jumper set in this position and should only be used when the standard firmware update process fails. This jumper should remain in the default (disabled) position (pins 1-2) when the server is running normally.
- When performing a normal BIOS update procedure, the BIOS recovery jumper must be set to its default position (pins 1-2).

Appendix B: Integrated BMC Sensor Tables

Intel® Server Board S1200BTL implements the below sensors:

Sensor Type Codes

Sensor table given below lists the sensor identification numbers and information regarding the sensor type, name, supported thresholds, assertion and de-assertion information, and a brief description of the sensor purpose. Refer to the *Intelligent Platform Management Interface Specification, Version 2.0* for sensor and event/reading-type table information.

- **Sensor Type**
The sensor type references the values in the Sensor Type Codes table in the Intelligent Platform Management Interface Specification Second Generation v2.0. It provides a context to interpret the sensor.
- **Event/Reading Type**
The event/reading type references values from the Event/Reading Type Code Ranges and the Generic Event/Reading Type Code tables in the Intelligent Platform Management Interface Specification Second Generation v2.0. Digital sensors are specific type of discrete sensors that only have two states.
- **Event Thresholds/Triggers**
The following event thresholds are supported for threshold type sensors:
[u,l][nr,c,nc] upper non-recoverable, upper critical, upper non-critical, lower non-recoverable, lower critical, lower non-critical
uc, lc upper critical, lower critical
Event triggers are supported event-generating offsets for discrete type sensors. The offsets can be found in the *Generic Event/Reading Type Code* or *Sensor Type Code* tables in the *Intelligent Platform Management Interface Specification Second Generation v2.0*, depending on whether the sensor event/reading type is generic or a sensor-specific response.
- **Assertion/Deassertion**
Assertion and de-assertion indicators reveal the type of events this sensor generates:
As: Assertion
De: De-assertion
- **Readable Value/Offsets**
Readable value indicates the type of value returned for threshold and other non-discrete type sensors.
Readable offsets indicate the offsets for discrete sensors that are readable by means of the *Get Sensor Reading* command. Unless otherwise indicated, event triggers are readable. Readable offsets consist of the reading type offsets that do not generate events.
- **Event Data**
Event data is the data that is included in an event message generated by the associated sensor. For threshold-based sensors, these abbreviations are used:
R: Reading value

T: Threshold value

- **Rearm Sensors**

The rearm is a request for the event status for a sensor to be rechecked and updated upon a transition between good and bad states. Rearming the sensors can be done manually or automatically. This column indicates the type supported by the sensor. The following abbreviations are used in the comment column to describe a sensor:

A: Auto-rearm

M: Manual rearm

I: Rearm by init agent

- **Default Hysteresis**

The hysteresis setting applies to all thresholds of the sensor. This column provides the count of hysteresis for the sensor, which can be 1 or 2 (positive or negative hysteresis).

- **Criticality**

Criticality is a classification of the severity and nature of the condition. It also controls the behavior of the front panel status LED.

- **Standby**

Some sensors operate on standby power. These sensors may be accessed and/or generate events when the main (system) power is off, but AC power is present.

Table 56. BMC Core Sensors

Full Sensor Name (Sensor name in SDR)	Sensor #	Platform Applicability	Sensor Type	Event/Reading Type	Event Offset Triggers	Contrib. To System Status	Assert/De-assert	Readable Value/Offsets	Event Data	Rearm	Stand-by
Power Unit Status (Pwr Unit Status)	01h	All	Power Unit 09h	Sensor Specific 6Fh	00 - Power down	OK	As and De	-	Trig Offset	A	X
					04 - A/C lost						
					05 - Soft power control failure	Fatal					
					06 - Power unit failure						
Power Unit Redundancy1 (Pwr Unit Redund)	02h	Chassis-specific	Power Unit 09h	Generic 0Bh	00 - Fully Redundant	OK	As and De	-	Trig Offset	A	X
					01 - Redundancy lost	Degraded					
					02 - Redundancy degraded	Degraded					
					03 - Non-redundant: sufficient resources. Transition from full redundant state.	Degraded					
					04 - Non-redundant: sufficient resources. Transition from insufficient state.	Degraded					
					05 - Non-redundant: insufficient resources	Fatal					
					06 - Redundant: degraded from fully redundant state.	Degraded					
					07 - Redundant: Transition from non-redundant state.	Degraded					
IPMI Watchdog	03h	All	Watchdog 2	Sensor Specific	00 - Timer expired, status only	OK	As	-	Trig Offset	A	X

Full Sensor Name (Sensor name in SDR)	Sensor #	Platform Applicability	Sensor Type	Event/Reading Type	Event Offset Triggers	Contrib. To System Status	Assert/De-assert	Readable Value/Offsets	Event Data	Rearm	Stand-by
(IPMI Watchdog)			23h	6Fh	01 - Hard reset						
					02 - Power down						
					03 - Power cycle						
					08 - Timer interrupt						
Physical Security (Physical Scrty)	04h	Chassis Intrusion is chassis-specific	Physical Security 05h	Sensor Specific 6Fh	00 - Chassis intrusion	OK	As and De	-	Trig Offset	A	X
					04 - LAN leash lost						
FP Interrupt (FP NMI Diag Int)	05h	Chassis - specific	Critical Interrupt 13h	Sensor Specific 6Fh	00 - Front panel NMI / diagnostic interrupt	OK	As	-	Trig Offset	A	-
SMI Timeout (SMI Timeout)	06h	All	SMI Timeout F3h	Digital Discrete 03h	01 - State asserted	Fatal	As and De	-	Trig Offset	A	-
System Event Log (System Event Log)	07h	All	Event Logging Disabled 10h	Sensor Specific 6Fh	02 - Log area reset / cleared	OK	As	-	Trig Offset	A	X
System Event (System Event)	08h	All	System Event 12h	Sensor Specific 6Fh	04 - PEF action	OK	As	-	Trig Offset	A	X
Button Sensor (Button)	09h	All	Button/Switch 14h	Sensor Specific 6Fh	00 - Power Button 02 - Reset Button	OK	AS	-	Trig Offset	A	X
PCH Thermal Trip (PCH Therm Trip)	0Dh	All	Temperature 01h	Digital Discrete 03h	01 - State Asserted	Fatal	As and De	-	Trig Offset	M	X
Baseboard Temperature 1 (Baseboard Temp)	20h	All	Temperature 01h	Threshold 01h	[u,l] [c,nc]	nc = Degraded c = Non-fatal	As and De	Analog	R, T	A	X
Front Panel Temperature (Front Panel Temp)	21h	All	Temperature 01h	Threshold 01h	[u,l] [c,nc]	nc = Degraded c = Non-fatal	As and De	Analog	R, T	A	X

Full Sensor Name (Sensor name in SDR)	Sensor #	Platform Applicability	Sensor Type	Event/Reading Type	Event Offset Triggers	Contrib. To System Status	Assert/De-assert	Readable Value/Offsets	Event Data	Rearm	Stand-by
PCH TemperatureNote1 (PCH Temp)	22h	All	Temperature 01h	Threshold 01h	[u,l] [c,nc]	nc = Degraded c = Non-fatal	As and De	Analog	R, T	A	X
Baseboard Temperature 3 (Inlet Temp)	24h	All	Temperature 01h	Threshold 01h	[u,l] [c,nc]	nc = Degraded c = Non-fatal	As and De	Analog	R, T	A	X
Hot-swap Backplane Temperature (HSBP Temp)	29h	All	Temperature 01h	Threshold 01h	[u,l] [c,nc]	nc = Degraded c = Non-fatal	As and De	Analog	R, T	A	X
Fan Tachometer Sensors (Chassis specific sensor names)	30h–34h	Chassis-specific	Fan 04h	Threshold 01h	[l] [c,nc]	nc = Degraded c = Non-fatal2	As and De	Analog	R, T	M	-
Power Supply 1 Status (PS1 Status)	50h	Chassis-specific	Power Supply 08h	Sensor Specific 6Fh	00 - Presence	OK	As and De	-	Trig Offset	A	X
					01 - Failure	Degraded					
					02 - Predictive Failure	Degraded					
					03 - A/C lost	Degraded					
					06 - Configuration error	OK					
Power Supply 2 Status (PS2 Status)	51h	Chassis-specific	Power Supply 08h	Sensor Specific 6Fh	00 - Presence	OK	As and De	-	Trig Offset	A	X
					01 - Failure	Degraded					
					02 - Predictive Failure	Degraded					
					03 - A/C lost	Degraded					
					06 - Configuration error	OK					
Power Supply 1 AC Power Input (PS1 Power In)	54h	Chassis-specific	Other Units 0Bh	Threshold 01h	[u] [c,nc]	nc = Degraded c = Non-fatal	As and De	Analog	R, T	A	X
Power Supply 2 AC Power Input (PS2 Power In)	55h	Chassis-specific	Other Units 0Bh	Threshold 01h	[u] [c,nc]	nc = Degraded c = Non-fatal	As and De	Analog	R, T	A	X

Full Sensor Name (Sensor name in SDR)	Sensor #	Platform Applicability	Sensor Type	Event/Reading Type	Event Offset Triggers	Contrib. To System Status	Assert/De-assert	Readable Value/Offsets	Event Data	Rearm	Stand-by
Power Supply 1 +12V % of Maximum Current Output (PS1 Curr Out %)	58h	Chassis-specific	Current 03h	Threshold 01h	[u] [c,nc]	nc = Degraded c = Non-fatal	As and De	Analog	R, T	A	X
Power Supply 2 +12V % of Maximum Current Output (PS2 Curr Out %)	59h	Chassis-specific	Current 03h	Threshold 01h	[u] [c,nc]	nc = Degraded c = Non-fatal	As and De	Analog	R, T	A	X
Power Supply 1 Temperature (PS1 Temperature)	5Ch	Chassis-specific	Temperature 01h	Threshold 01h	[u] [c,nc]	nc = Degraded c = Non-fatal	As and De	Analog	R, T	A	X
Power Supply 2 Temperature (PS2 Temperature)	5Dh	Chassis-specific	Temperature	Threshold 01h	[u] [c,nc]	nc = Degraded c = Non-fatal	As and De	Analog	R, T	A	X
Processor Status (P1 Status)	70h	All	Processor 07h	Sensor Specific 6Fh	01 - Thermal trip	Fatal	As and De	-	Trig Offset	M	X
					07 - Presence	OK					
Processor Thermal Margin (P1 Therm Margin)	74h	All	Temperature 01h	Threshold 01h	—	—	-	Analog	R, T	A	—
Processor Thermal Control % (P1 Therm Ctrl %)	78h	All	Temperature 01h	Threshold 01h	[u] [c,nc]	nc = Degraded c = Non-fatal	As and De	Analog	Trig Offset	A	—
Catastrophic Error (CATERR)	80h	All	Processor 07h	Digital Discrete 03h	01 – State Asserted	Non-fatal	As and De	–	Trig Offset	M	–
MSID Mismatch (MSID Mismatch)	81h	All	Processor 07h	Digital Discrete 03h	01 – State Asserted	Non-fatal	As and De	–	Trig Offset	M	–
Processor Population Fault (CPU Missing)	82h	All	Processor 07h	Digital Discrete 03h	01 – State Asserted	Fatal	As and De	–	Trig Offset	M	–
Processor VRD Temperature (P1 VRD Hot)	90h	All	Temperature 01h	Digital Discrete 05h	01 - Limit exceeded	Fatal	As and De	–	Trig Offset	M	–

Full Sensor Name (Sensor name in SDR)	Sensor #	Platform Applicability	Sensor Type	Event/Reading Type	Event Offset Triggers	Contrib. To System Status	Assert/De-assert	Readable Value/Offsets	Event Data	Rearm	Stand-by
Power Supply 1 Fan Tachometer 1 (PS1 Fan Tach 1)	A0h	Chassis-specific	Fan 04h	Threshold 01h	–	–	–	Analog	–	–	–
Power Supply 1 Fan Tachometer 2 (PS1 Fan Tach 2)	A1h	Chassis-specific	Fan 04h	Threshold 01h	–	–	–	Analog	–	–	–
Power Supply 2 Fan Tachometer 1 (PS2 Fan Tach 1)	A4h	Chassis-specific	Fan 04h	Threshold 01h	–	–	–	Analog	–	–	–
Power Supply 2 Fan Tachometer 2 (PS2 Fan Tach 2)	A5h	Chassis-specific	Fan 04h	Threshold 01h	–	–	–	Analog	–	–	–
Processor DIMM Aggregate Thermal Margin (Mem P1 Thrm Mrgn)	B0h	All	Temperature 01h	Threshold 01h	[u,l] [c,nc]	nc = Degraded c = Non-fatal	As and De	Analog	R, T	A	–
Processor DIMM Thermal Trip (Mem P1 Thrm Trip)	C0h	All	Temperature 01h	Digital Discrete 03h	01 – State Asserted	Fatal	As and De	–	Trig Offset	M	X
Baseboard +12V (BB +12.0V)	D0h	All	Voltage 02h	Threshold 01h	[u,l] [c,nc]	nc = Degraded c = Non-fatal	As and De	Analog	R, T	A	–
Baseboard +5V (BB +5.0V)	D1h	All	Voltage 02h	Threshold 01h	[u,l] [c,nc]	nc = Degraded c = Non-fatal	As and De	Analog	R, T	A	–
Baseboard +3.3V (BB +3.3V)	D2h	All	Voltage 02h	Threshold 01h	[u,l] [c,nc]	nc = Degraded c = Non-fatal	As and De	Analog	R, T	A	–
Baseboard +5V Stand-by (BB +5.0V STBY)	D3h	All	Voltage 02h	Threshold 01h	[u,l] [c,nc]	nc = Degraded c = Non-fatal	As and De	Analog	R, T	A	X
Baseboard +3.3V Auxiliary (BB +3.3V AUX)	D4h	All	Voltage 02h	Threshold 01h	[u,l] [c,nc]	nc = Degraded c = Non-fatal	As and De	Analog	R, T	A	X

Full Sensor Name (Sensor name in SDR)	Sensor #	Platform Applicability	Sensor Type	Event/Reading Type	Event Offset Triggers	Contrib. To System Status	Assert/De-assert	Readable Value/Offsets	Event Data	Rearm	Stand-by
Baseboard +1.2V Processor Vccp (BB P1 Vccp)	D6h	All	Voltage 02h	Threshold 01h	[u,l] [c,nc]	nc = Degraded c = Non-fatal	As and De	Analog	R, T	A	–
Baseboard +1.5V VDDQ (BB +1.5V P1 MEM)	D8h	All	Voltage 02h	Threshold 01h	[u,l] [c,nc]	nc = Degraded c = Non-fatal	As and De	Analog	R, T	A	–
Baseboard CMOS Battery (BB +3.3V Vbat)	DEh	All	Voltage 02h	Threshold 01h	[u,l] [c,nc]	nc = Degraded c = Non-fatal	As and De	Analog	R, T	A	–
Baseboard Processor Vcc (BB P1 Vcc)	E0h	All	Voltage 02h	Threshold 01h	[u,l] [c,nc]	nc = Degraded c = Non-fatal	As and De	Analog	R, T	A	–
Baseboard Processor VccUSA (BB P1 VccUSA)	E1h	All	Voltage 02h	Threshold 01h	[u,l] [c,nc]	nc = Degraded c = Non-fatal	As and De	Analog	R, T	A	–
Baseboard +1.05V PCH (BB +1.05V PCH)	E2h	All	Voltage 02h	Threshold 01h	[u,l] [c,nc]	nc = Degraded c = Non-fatal	As and De	Analog	R, T	A	–
Baseboard +1.05V Auxiliary (BB +1.05V AUX)	E3h	All	Voltage 02h	Threshold 01h	[u,l] [c,nc]	nc = Degraded c = Non-fatal	As and De	Analog	R, T	A	X
Baseboard +1.35V VDDQ (BB +1.35V P1 MEM)	E4h	All	Voltage 02h	Threshold 01h	[u,l] [c,nc]	nc = Degraded c = Non-fatal	As and De	Analog	R, T	A	–
Baseboard +12.0V V1 (BB +12.0V V1)	E8h	All	Voltage 02h	Threshold 01h	[u,l] [c,nc]	nc = Degraded c = Non-fatal	As and De	Analog	R, T	A	–
Baseboard +1.5V Auxiliary (BB +1.5V AUX)	E9h	All	Voltage 02h	Threshold 01h	[u,l] [c,nc]	nc = Degraded c = Non-fatal	As and De	Analog	R, T	A	X
Hard Disk Drive 0 Status	F0h	Chassis-specific	Drive Slot	Sensor Specific	00 - Drive Presence	OK	As and De	–	Trig Offset	A	X
					01- Drive Fault	Degraded					

Full Sensor Name (Sensor name in SDR)	Sensor #	Platform Applicability	Sensor Type	Event/Reading Type	Event Offset Triggers	Contrib. To System Status	Assert/De-assert	Readable Value/Offsets	Event Data	Rearm	Stand-by
(HDD 0 Status)			0Dh	6Fh	02- Predictive Failure	Degraded					
					07 - Rebuild/Remap in progress	Degraded					
Hard Disk Drive 1 Status (HDD 1 Status)	F1h	Chassis-specific	Drive Slot 0Dh	Sensor Specific 6Fh	00 - Drive Presence	OK	As and De	-	Trig Offset	A	X
					01- Drive Fault	Degraded					
					02- Predictive Failure	Degraded					
					07 - Rebuild/Remap in progress	Degraded					
Hard Disk Drive 2 Status (HDD 2 Status)	F2h	Chassis-specific	Drive Slot 0Dh	Sensor Specific 6Fh	00 - Drive Presence	OK	As and De	-	Trig Offset	A	X
					01- Drive Fault	Degraded					
					02- Predictive Failure	Degraded					
					07 - Rebuild/Remap in progress	Degraded					
Hard Disk Drive 3 Status (HDD 3 Status)	F3h	Chassis-specific	Drive Slot 0Dh	Sensor Specific 6Fh	00 - Drive Presence	OK	As and De	-	Trig Offset	A	
					01- Drive Fault	Degraded					
					02- Predictive Failure	Degraded					
					07 - Rebuild/Remap in progress	Degraded					

Appendix C: POST Code Diagnostic LED Decoder

During the system boot process, the BIOS executes a number of platform configuration processes, each of which is assigned a specific hex POST code number. As each configuration routine is started, the BIOS displays the POST code to the POST Code Diagnostic LEDs on the back edge of the server board. To assist in troubleshooting a system hang during the POST process, you can use the diagnostic LEDs to identify the last POST process executed.

Later in POST, the BIOS displays POST Error Codes on the video monitor in the Error Manager display. Any POST Error Codes are automatically logged in the event log.

The Diagnostic LEDs are a set of LEDs found on the back edge of the server board. The exact implementation may differ for some boards, but in general there are 8 Diagnostic LEDs which form a 2 hex digit (8 bit) code read left-to-right as facing the rear of the server.

An LED which is ON represents a 1 bit value, and an LED which is OFF represents a 0 bit value. The LED bit values are read as Most Significant Bit to the left, Least Significant Bit to the right.

In the following example, the BIOS sends a value of ACh to the diagnostic LED decoder. The LEDs are decoded as follows:

Table 57. POST Progress Code LED Example

LEDs	Upper Nibble LEDs				Lower Nibble LEDs			
	MSB							LSB
	LED #7	LED #6	LED #5	LED #4	LED #3	LED #2	LED #1	LED #0
	8h	4h	2h	1h	8h	4h	2h	1h
Status	ON	OFF	ON	OFF	ON	OFF	ON	OFF
Results	1	0	1	0	1	1	0	0
	Ah				Ch			

- Upper nibble bits = 1010b = Ah; Lower nibble bits = 1100b = Ch; the two are concatenated as ACh.

Table 58. POST Progress Codes

Progress Code	Diagnostic LED Decoder 0 = On, X=Off								Description		
	Upper Nibble				Lower Nibble						
	MSB	8h	4h	2h	1h	8h	4h	2h	1h	LSB	
	#7	#6	#5	#4	#3	#2	#1	#0			
SEC Phase											
0x01	X	X	X	X	X	X	X	O			First POST code after CPU reset
0x02	X	X	X	X	X	X	O	X			CPU Microcode load begin
0x03	X	X	X	X	X	X	O	O			Cache As RAM initialization begin
0x05	X	X	X	X	X	O	X	O			SEC Core at Power On Begin.

Progress Code	Diagnostic LED Decoder 0 = On, X=Off								Description		
	Upper Nibble				Lower Nibble						
	MSB	8h	4h	2h	1h	8h	4h	2h		1h	LSB
	#7	#6	#5	#4	#3	#2	#1	#0			
0x06	X	X	X	X	X	O	O	X	Early CPU initialization during Sec Phase		
0x07	X	X	X	X	X	O	O	O	Early South Bridge initialization		
0x08	X	X	X	X	O	X	X	X	Early North Bridge initialization		
0x09	X	X	X	X	O	X	X	O	End Of Sec Phase		
0x0E	X	X	X	X	O	O	O	X	CPU Microcode Not Found.		
0x0F	X	X	X	X	O	O	O	O	CPU Microcode Not Loaded.		
PEI Phase											
0x10	X	X	X	O	X	X	X	X	PEI Core Starts		
0x11	X	X	X	O	X	X	X	O	CPU PEI Module Starts		
0x15	X	X	X	O	X	O	X	O	North Bridge PEI Module Starts		
0x19	X	X	X	O	O	X	X	O	South Bridge PEI Module Starts		
0x31	X	X	O	O	X	X	X	O	Memory Installed		
0x32	X	X	O	O	X	X	O	X	CPU PEI Module for CPU initialization		
0x33	X	X	O	O	X	X	O	O	CPU PEI Module for Cache initialization		
0x34	X	X	O	O	X	O	X	X	CPU PEI Module for Boot Strap Processor Select		
0x35	X	X	O	O	X	O	X	O	CPU PEI Module for Application Processor initialization		
0x36	X	X	O	O	X	O	O	X	CPU PEI Module for CPU SMM initialization		
0x4F	X	O	X	X	O	O	O	O	Dxe IPL started		
DXE Phase											
0x60	X	O	O	X	X	X	X	X	DXE Core started		
0x61	X	O	O	X	X	X	X	O	DXE NVRAM initialization		
0x62	X	O	O	X	X	X	O	X	SB RUN initialization		
0x63	X	O	O	X	X	X	O	O	Dxe CPU initialization		
0x68	X	O	O	X	O	X	X	X	DXE PCI Host Bridge initialization		
0x69	X	O	O	X	O	X	X	O	DXE NB initialization		
0x6A	X	O	O	X	O	X	O	X	DXE NB SMM initialization		
0x70	X	O	O	O	X	X	X	X	DXE SB initialization		

Progress Code	Diagnostic LED Decoder 0 = On, X=Off								Description
	Upper Nibble				Lower Nibble				
	MSB	8h	4h	2h 1h	8h	4h	2h 1h	LSB	
	#7	#6	#5	#4	#3	#2	#1	#0	
0x71	X	O	O	O	X	X	X	O	DXE SB SMM initialization
0x72	X	O	O	O	X	X	O	X	DXE SB devices initialization
0x78	X	O	O	O	O	X	X	X	DXE ACPI initialization
0x79	X	O	O	O	O	X	X	O	DXE CSM initialization
0x90	O	X	X	O	X	X	X	X	DXE BDS Started
0x91	O	X	X	O	X	X	X	O	DXE BDS connect drivers
0x92	O	X	X	O	X	X	O	X	DXE PCI Bus begin
0x93	O	X	X	O	X	X	O	O	DXE PCI Bus HPC initialization
0x94	O	X	X	O	X	O	X	X	DXE PCI Bus enumeration
0x95	O	X	X	O	X	O	X	O	DXE PCI Bus resource requested
0x96	O	X	X	O	X	O	O	X	DXE PCI Bus assign resource
0x97	O	X	X	O	X	O	O	O	DXE CON_OUT connect
0x98	O	X	X	O	O	X	X	X	DXE CON_IN connect
0x99	O	X	X	O	O	X	X	O	DXE SIO initialization
0x9A	O	X	X	O	O	X	O	X	DXE USB start
0x9B	O	X	X	O	O	X	O	O	DXE USB reset
0x9C	O	X	X	O	O	O	X	X	DXE USB detect
0x9D	O	X	X	O	O	O	X	O	DXE USB enable
0xA1	O	X	O	X	X	X	X	O	DXE IDE begin
0xA2	O	X	O	X	X	X	O	X	DXE IDE reset
0xA3	O	X	O	X	X	X	O	O	DXE IDE detect
0xA4	O	X	O	X	X	O	X	X	DXE IDE enable
0xA9	O	X	O	X	O	X	X	O	DXE verifying SETUP password
0xAB	O	X	O	X	O	X	O	O	DXE SETUP start
0xAC	O	X	O	X	O	O	X	X	DXE SETUP input wait
0xAD	O	X	O	X	O	O	X	O	DXE Ready to Boot
0xAE	O	X	O	X	O	O	O	X	DXE Legacy Boot
0xAF	O	X	O	X	O	O	O	O	DXE Exit Boot Services
0xB0	O	X	O	O	X	X	X	X	RT Set Virtual Address Map Begin

Progress Code	Diagnostic LED Decoder 0 = On, X=Off								Description
	Upper Nibble				Lower Nibble				
	MSB	8h	4h	2h 1h	8h	4h	2h 1h	LSB	
	#7	#6	#5	#4	#3	#2	#1	#0	
0xB1	0	X	0	0	X	X	X	0	RT Set Virtual Address Map End
0xB2	0	X	0	0	X	X	0	X	DXE Legacy Option ROM init
0xB3	0	X	0	0	X	X	0	0	DXE Reset system
0xB4	0	X	0	0	X	0	X	X	DXE USB Hot plug
0xB5	0	X	0	0	X	0	X	0	DXE PCI BUS Hot plug
0xB6	0	X	0	0	X	0	0	X	DXE NVRAM cleanup
0xB7	0	X	0	0	0	0	0	0	DXE Configuration Reset
0x00	X	X	X	X	X	X	X	X	INT19
BIOS Recovery									
0xF0	0	0	0	0	X	X	X	X	PEIM which detected forced Recovery condition
0xF1	0	0	0	0	X	X	X	0	PEIM which detected User Recovery condition
0xF2	0	0	0	0	X	X	0	X	Recovery PEIM (Recovery started)
0xF3	0	0	0	0	X	X	0	0	Recovery PEIM (Capsule found)
0xF4	0	0	0	0	X	0	X	X	Recovery PEIM (Capsule loaded)

Appendix D: POST Code Errors

The BIOS outputs the current boot progress codes on the video screen. Progress codes are 32-bit quantities plus optional data. The 32-bit numbers include class, subclass, and operation information. The class and subclass fields point to the type of hardware that is being initialized. The operation field represents the specific initialization activity. Based on the data bit availability to display progress codes, a progress code can be customized to fit the data width. The higher the data bit, the higher the granularity of information that can be sent on the progress port. The progress codes may be reported by the system BIOS or option ROMs.

The Response section in the following table is divided into three types:

- **No Pause:** The message displays on the screen during POST or in the Error Manager. The system continues booting with a degraded state. The user may want to replace the erroneous unit. The setup POST error Pause setting does not have any effect with this error.
- **Pause:** The message displays on the Error Manager screen, and an error is logged to the SEL. The setup POST error Pause setting determines whether the system pauses to the Error Manager for this type of error, where the user can take immediate corrective action or choose to continue booting.
- **Halt:** The message displays on the Error Manager screen, an error is logged to the SEL, and the system cannot boot unless the error is resolved. The user must replace the faulty part and restart the system. The setup POST error Pause setting does not have any effect with this error.

For example:

- Error Code 8540 = DIMM_A1 disabled
 - Error Class 85 = DIMM error
 - Error Subclass 4 = DIMM disabled
 - Error Descriptor 0 = DIMM_A1 is the DIMM that has been disabled

Be aware that these POST Error Codes must be coordinated with the Server Management Utilities team, which maintains a “master list” of these codes.

Table 59. POST Error Codes and Messages

Error Code	Error Message	Response
0012	CMOS date/time not set	Major
0048	Password check failed	Major
0140	PCI component encountered a PERR error	Major
0141	PCI resource conflict	Major
0146	PCI out of resources error	Major
5220	CMOS/NVRAM configuration cleared	Major
5221	Passwords cleared by jumper	Major
5224	Password clear jumper is Set	Major
8160	Processor 01 unable to apply microcode update	Major

Error Code	Error Message	Response
8180	Processor 01 microcode update not found	Minor
8190	Watchdog timer failed on last boot	Major
8198	OS boot watchdog timer failure	Major
8300	Baseboard management controller failed self-test	Major
8305	Hot Swap Controller failure	Major
83A0	Management Engine (ME) failed Selftest	Major
83A1	Management Engine (ME) Failed to respond.	Major
84F2	Baseboard management controller failed to respond	Major
84F3	Baseboard management controller in update mode	Major
84F4	Sensor data record empty	Major
84FF	System event log full	Minor
8500	Memory component could not be configured in the selected RAS mode	Major
8501	DIMM Population Error	Major
8520	DIMM_A1 failed test/initialization	Major
8521	DIMM_A2 failed test/initialization	Major
8523	DIMM_B1 failed test/initialization	Major
8524	DIMM_B2 failed test/initialization	Major
8540	DIMM_A1 disabled	Major
8541	DIMM_A2 disabled	Major
8543	DIMM_B1 disabled	Major
8544	DIMM_B2 disabled	Major
9667	PEI module component encountered an illegal software state error.	Fatal
9687	PEI module component encountered an illegal software state error.	Fatal
96A7	PEI module component encountered an illegal software state error.	Fatal
A000	TPM device not detected.	Minor
A001	TPM device missing or not responding.	Minor
A002	TPM device failure.	Minor
A003	TPM device failed self test.	Minor
A100	BIOS ACM Error	Major
A421	PCI component encountered a SERR error.	Fatal
A5A0	PCI Express component encountered a PERR error.	Minor
A5A1	PCI Express component encountered a SERR error.	Fatal

POST Error Beep Codes

The following table lists POST error beep codes. Prior to system video initialization, the BIOS uses these beep codes to inform users on error conditions. The beep code is followed by a user-visible code on POST Progress LEDs.

Table 60. POST Error Beep Codes

Beeps	Error Message	POST Progress Code	Description
3	Memory error	Multiple	System halted because a fatal error related to the memory was detected.
The following Beep Codes are from the BMC, and are controlled by the Firmware team. They are listed here for convenience.			
1-5-2-1	CPU socket population error	N/A	CPU1 socket is empty.
1-5-2-4	MSID Mismatch	N/A	MSID mismatch occurs if a processor is installed into a system board that has incompatible power capabilities.
1-5-4-2	Power fault	N/A	DC power unexpectedly lost (power good dropout) – Power unit sensors report power unit failure offset
1-5-4-4	Power control fault	N/A	Power good assertion timeout – Power unit sensors report soft power control failure offset

Appendix E: Supported Intel® Server Chassis

The Intel® Server Board S1200BT is supported in the following Intel® server chassis:

1. Intel® Server Chassis P4304XXSFCN
2. Intel® Server Chassis P4304XXSHCN

Glossary

This appendix contains important terms used in this document. For ease of use, numeric entries are listed first (for example, “82460GX”) followed by alpha entries (for example, “AGP 4x”). Acronyms are followed by non-acronyms.

Term	Definition
ACPI	Advanced Configuration and Power Interface
AP	Application Processor
APIC	Advanced Programmable Interrupt Control
ARP	Address Resolution Protocol
ASIC	Application Specific Integrated Circuit
ASMI	Advanced Server Management Interface
BIOS	Basic Input/Output System
BIST	Built-In Self Test
BMC	Baseboard Management Controller
Bridge	Circuitry connecting one computer bus to another, allowing an agent on one to access the other
BSP	Bootstrap Processor
Byte	8-bit quantity
CBC	Chassis Bridge Controller (A microcontroller connected to one or more other CBCs, together they bridge the IPMB buses of multiple chassis.
CEK	Common Enabling Kit
CHAP	Challenge Handshake Authentication Protocol
CMOS	Complementary Metal-oxide-semiconductor In terms of this specification, this describes the PC-AT compatible region of battery-backed 128 bytes of memory, which normally resides on the server board.
DHCP	Dynamic Host Configuration Protocol
DPC	Direct Platform Control
EEPROM	Electrically Erasable Programmable Read-Only Memory
EHCI	Enhanced Host Controller Interface
EMP	Emergency Management Port
EPS	External Product Specification
ESB2	Enterprise South Bridge 2
FBD	Fully Buffered DIMM
F MB	Flexible Mother Board
FRB	Fault Resilient Booting
FRU	Field Replaceable Unit
FSB	Front Side Bus
GB	1024 MB
GPA	Guest Physical Address
GPIO	General Purpose I/O
GTL	Gunning Transceiver Logic
HPA	Host Physical Address
HSC	Hot-swap Controller

Term	Definition
Hz	Hertz (1 cycle/second)
I2C	Inter-Integrated Circuit Bus
IA	Intel® Architecture
IBF	Input Buffer
ICH	I/O Controller Hub
ICMB	Intelligent Chassis Management Bus
IERR	Internal Error
IFB	I/O and Firmware Bridge
ILM	Independent Loading Mechanism
IMC	Integrated Memory Controller
INTR	Interrupt
I/OAT	I/O Acceleration Technology
IOH	I/O Hub
IP	Internet Protocol
IPMB	Intelligent Platform Management Bus
IPMI	Intelligent Platform Management Interface
IR	Infrared
ITP	In-Target Probe
KB	1024 bytes
KCS	Keyboard Controller Style
KVM	Keyboard, Video, Mouse
LAN	Local Area Network
LCD	Liquid Crystal Display
LDAP	Local Directory Authentication Protocol
LED	Light Emitting Diode
LPC	Low Pin Count
LUN	Logical Unit Number
MAC	Media Access Control
MB	1024 KB
MCH	Memory Controller Hub
MD2	Message Digest 2 – Hashing Algorithm
MD5	Message Digest 5 – Hashing Algorithm – Higher Security
ME	Management Engine
MMU	Memory Management Unit
ms	Milliseconds
MTTR	Memory Type Range Register
Mux	Multiplexor
NIC	Network Interface Controller
NMI	Non-maskable Interrupt
OBF	Output Buffer
OEM	Original Equipment Manufacturer
Ohm	Unit of electrical resistance

Term	Definition
OVP	Over-voltage Protection
PECI	Platform Environment Control Interface
PEF	Platform Event Filtering
PEP	Platform Event Paging
PIA	Platform Information Area (This feature configures the firmware for the platform hardware)
PLD	Programmable Logic Device
PMI	Platform Management Interrupt
POST	Power-On Self Test
PSMI	Power Supply Management Interface
PWM	Pulse-Width Modulation
QPI	QuickPath Interconnect
RAM	Random Access Memory
RASUM	Reliability, Availability, Serviceability, Usability, and Manageability
RISC	Reduced Instruction Set Computing
RMII	Reduced Media-Independent Interface
ROM	Read Only Memory
RTC	Real-Time Clock (Component of ICH peripheral chip on the server board)
SDR	Sensor Data Record
SECC	Single Edge Connector Cartridge
SEEPROM	Serial Electrically Erasable Programmable Read-Only Memory
SEL	System Event Log
SIO	Server Input/Output
SMBUS	System Management BUS
SMI	Server Management Interrupt (SMI is the highest priority non-maskable interrupt)
SMM	Server Management Mode
SMS	Server Management Software
SNMP	Simple Network Management Protocol
SPS	Server Platform Services
SSE2	Streaming SIMD Extensions 2
SSE3	Streaming SIMD Extensions 3
SSE4	Streaming SIMD Extensions 4
TBD	To Be Determined
TDP	Thermal Design Power
TIM	Thermal Interface Material
UART	Universal Asynchronous Receiver/Transmitter
UDP	User Datagram Protocol
UHCI	Universal Host Controller Interface
URS	Unified Retention System
UTC	Universal Time Coordinate
VID	Voltage Identification
VRD	Voltage Regulator Down
VT	Virtualization Technology

Term	Definition
Word	16-bit quantity
WS-MAN	Web Services for Management
ZIF	Zero Insertion Force

Reference Documents

Refer to the following documents for additional information:

- *Intel® Server Board S1200BT BIOS External Product Specification*
- *Intel® Server Board S1200BT Common Core Integrated BMC External Product Specification*