

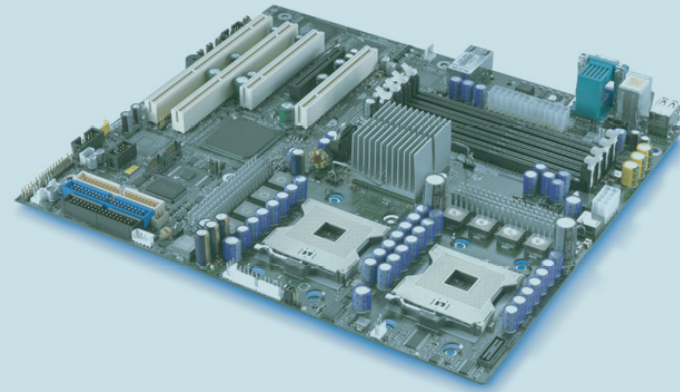

Intel® Server Board SE7525RP2/SE7320EP2 Quick Start User's Guide

Thank you for buying an Intel® Server Board. The information in this guide will help you to integrate your Intel® Server Board SE7525RP2 or SE7320EP2 into a chassis. The Intel® Entry Server Chassis SC5275-E and the Intel® Entry Server Chassis SC5295-E are designed for use with the Intel® Server Boards SE7525RP2 and SE7320EP2. When installing the server board into a reference chassis, refer to the reference chassis instructions.



These latest documentation is located on the web at <http://support.intel.com/support/motherboards/server/SE7525RP2/> <http://support.intel.com/support/motherboards/server/SE7320EP2/> You can also find documentation on the CD that accompanied the Intel® Server Board SE7525RP2 or SE7320EP2.

If you are not familiar with ESD (Electrostatic Discharge) procedures used during system integration, please see the Intel® Server Board SE7525RP2/SE7320EP2 User Guide, available on the Intel® Server Board SE7525RP2/SE7320EP2 Server Deployment Toolkit CD or at <http://support.intel.com/support/motherboards/server/SE7525RP2/> <http://support.intel.com/support/motherboards/server/SE7320EP2/>

Warning

Read all caution and safety statements in this document before performing any of the instructions. Also see the *Intel® Server Board and Server Chassis Safety Information* document at: <http://support.intel.com/support/motherboards/server/> for complete safety information.

Warning

Installation and service of this product to be performed only by qualified service personnel to avoid risk of injury from electrical shock or energy hazard.

Caution

Observe normal ESD (Electrostatic Discharge) procedures during system integration to avoid possible damage to server board and/or other components.

Tools Required



Fastener Identification Guide

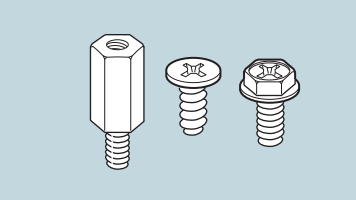

3

Record the Intel® Server Chassis Product Code

NOTE: Disregard this step if you are installing the server board in a non-Intel Server Chassis.

If installing this server board in an Intel® Server Chassis, you must record the product code for the chassis in order to configure the BIOS fan control. The product code is located on a label on the side or bottom of the Intel Server Chassis.



4

Install the Server Board Bumper

If installing this server board in an Intel® Server Chassis, use the bumper provided with the chassis.

Attach the bumper where indicated by the round silkscreened outline on the underside of the server board.

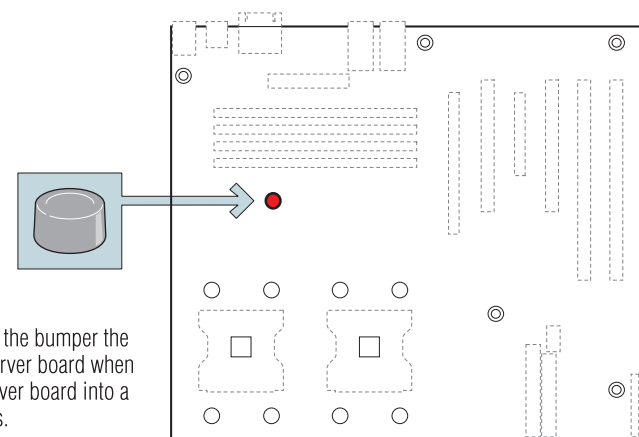

NOTE: Only use the bumper the ships with the server board when installing the server board into a non-Intel chassis.

Underside of server board

5

Install the Chassis Standoffs

Standoffs are included with your chassis. Standoff numbering varies by chassis. Standoff locations for the Intel® Entry Server Chassis SC5275-E and SC5295-E are shown below.

If standoffs are not already in place, install standoffs in positions A, C, E, F, K, the four positions marked P7, and the four positions marked P8.

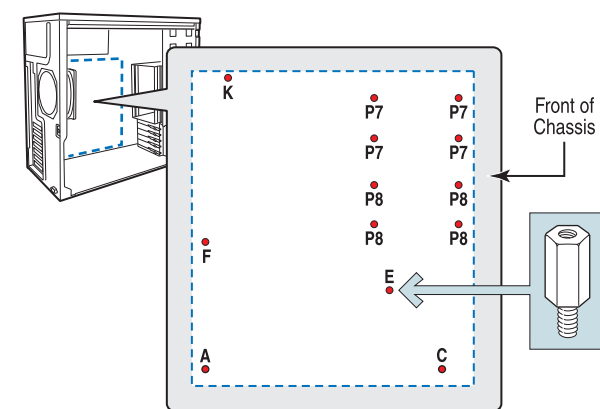

6

Install the Server Board

A. Check for Heat Sink Spring

Make sure the heat sink springs are installed on the underside of the board. If not, insert the spring clips through the matching holes around the processor, from the underside of the server board.

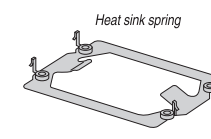

B. Insert the Server Board

Place the board into the chassis. Insert the front of the board first, then slide the board back so the I/O connectors fit through the I/O shield. Make sure the back panel I/O shield openings and chassis standoffs align correctly.

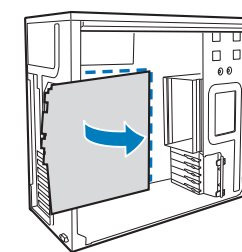

C. Attach the Server Board

Use screws to attach the board to the server at the 5 locations indicated by the figure.

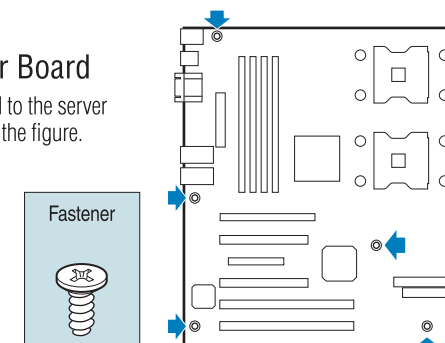

7

Install the Processor[s] and Heat Sink[s]

Notes and Cautions

- If only ONE processor is to be used, it must be installed in the Processor Socket 1.
- Do not mix processors of different types or frequencies.
- When unpacking a processor, hold by the edges only to avoid touching the pins.
- This server board has "zero-insertion force" sockets. If processor does not drop easily into socket holes, make sure lever is in the full-open position.

A. Open the Socket Lever

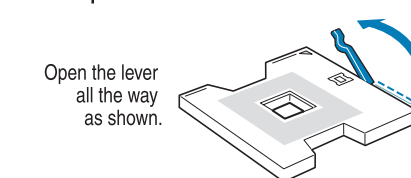

B. Install the Processor

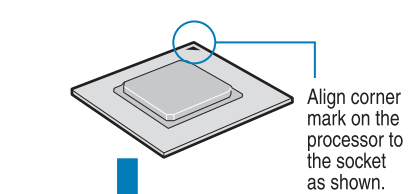

C. Close the Socket Lever

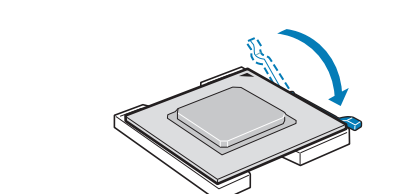

D. Connect Heat Sink Fan Cable(s)

For ease of installation, attach the fan cable(s) to the fan header(s) on the server board before installing the heat sink over the processor(s). See Step 9, letters F and H for the appropriate location(s).

E. Install the Heat Sink

The heat sink attaches directly to the chassis using the standoffs installed in Step 3. Each heat sink has four captive fasteners and should be tightened using the following procedure:

- Slightly tighten each fastener, going around the heat sink in a clockwise direction.
- Securely re-tighten each fastener again in the same order as performed in step A.

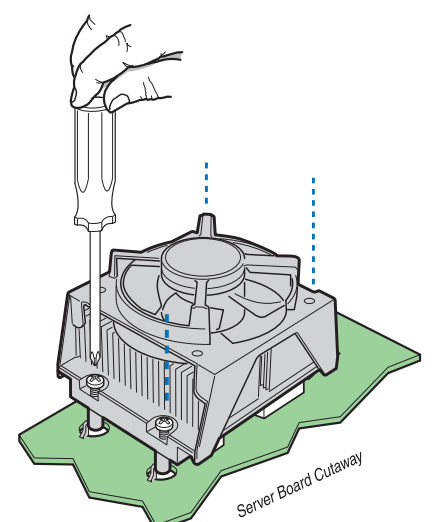

Building Value With Intel Server Products, Programs and Support

Get the high-value server solutions you need by taking advantage of the outstanding value Intel provides to system integrators:

- High-quality server building blocks
- Extensive breadth of server building blocks
- Solutions and tools to enable e-Business
- Intel® Server Management
- Comprehensive training services
- Worldwide 24x7 technical support [AT&T Country Code + 866-655-6565]¹
- World-class service, including a three-year limited warranty and Advanced Warranty Replacement¹

For more information on Intel's added-value server offerings, visit the Intel® ServerBuilder website at: www.intel.com/go/serverbuilder

Intel® ServerBuilder is your one-stop shop for information about all of Intel's Server Building Blocks such as:

- Product information, including product briefs and technical product specifications
- Sales tools, such as videos and presentations
- Training information, such as the Intel® Online Learning Center
- Support Information and much more

¹Available only to Intel® Channel Program Members, part of the Intel® e-Business Network.

Minimum Hardware Requirements

To avoid integration difficulties and possible board damage, your system must meet the following minimum requirements:

- Processor:** Minimum of one Intel® Xeon™ processor with an 800MHz FSB.
- Memory:** Minimum of one 256 MB, DDR2 400MHz-compliant registered SDRAM 240-pin DIMM.
- Power:** Must meet SSI EPS 12V specification. Depends on board and chassis:
 - For the Intel Entry Server Chassis SC5295-E DP with the Server Board SE7320EP2, a minimum 450W power supply is required.
 - For the Intel Entry Server Chassis SC5295-E RP with either the Server Board SE7320EP2 or SE7525RP2, a minimum 500W power supply is required.
 - For the Intel Entry Server Chassis SC5295WS with the Server Board SE7525RP2, a minimum 600W power supply is required.

1

Prepare the Chassis

When using an Intel® Server Chassis, begin with the Quick Start User's Guide that came with your chassis. Return to this document when directed. If using a non-Intel server chassis, refer to the documentation that came with your chassis for preparatory steps.

2

Install the I/O Shield and Gasket

A. Attach the gasket to the I/O shield

Remove the backing strips from the gasket.

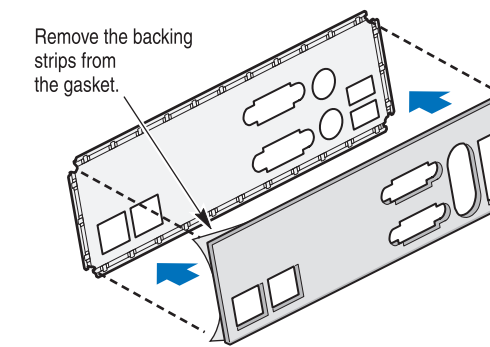

Press the gasket onto the **inside** face of the I/O shield as shown.

B. Attach the label to the I/O shield

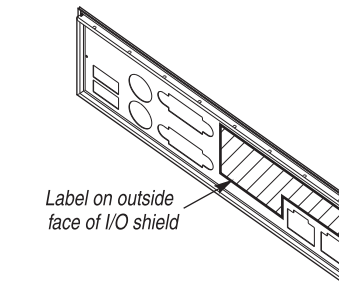

Remove the backing from the label included with your server board. Press the label onto the outside face of the I/O shield.

C. Install the I/O shield

Shield installs from **inside** of chassis. *The label should be visible from the outside of the chassis.*

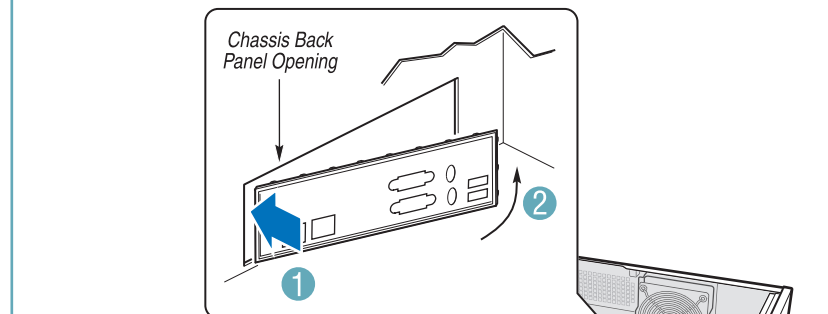

- Insert one side edge of shield as shown.
- Push shield firmly into chassis opening until it clicks into place.