

Intel® Server System SR9000MK4U Product Guide

Intel Order Number D71314-004

Disclaimer

Information in this document is provided in connection with Intel® products. No license, express or implied, by estoppel or otherwise, to any intellectual property rights is granted by this document. Except as provided in Intel's Terms and Conditions of Sale for such products, Intel assumes no liability whatsoever, and Intel disclaims any express or implied warranty, relating to sale and/or use of Intel products including liability or warranties relating to fitness for a particular purpose, merchantability, or infringement of any patent, copyright or other intellectual property right. Intel products are not designed, intended or authorized for use in any medical, life saving, or life sustaining applications or for any other application in which the failure of the Intel product could create a situation where personal injury or death may occur. Intel may make changes to specifications and product descriptions at any time, without notice.

Intel server boards contain a number of high-density VLSI and power delivery components that need adequate airflow for cooling. Intel's own chassis are designed and tested to meet the intended thermal requirements of these components when the fully integrated system is used together. It is the responsibility of the system integrator that chooses not to use Intel developed server building blocks to consult vendor datasheets and operating parameters to determine the amount of airflow required for their specific application and environmental conditions. Intel Corporation can not be held responsible if components fail or the server board does not operate correctly when used outside any of their published operating or non-operating limits.

Intel, Intel Pentium, and Intel Xeon are trademarks or registered trademarks of Intel Corporation or its subsidiaries in the United States and other countries.

* Other names and brands may be claimed as the property of others.

Copyright © 2006-2007, Intel Corporation. All Rights Reserved

Safety Information

Important Safety Instructions

Read all caution and safety statements in this document before performing any of the instructions. See also Intel Server Boards and Server Chassis Safety Information on the Resource CD and/or at <http://support.intel.com/support/motherboards/server/sb/cs-010770.htm>.

Wichtige Sicherheitshinweise

Lesen Sie zunächst sämtliche Warnund Sicherheitshinweise in diesem Dokument, bevor Sie eine der Anweisungen ausführen. Beachten Sie hierzu auch die Sicherheitshinweise zu Intel-Serverplatinen und Servergehäusen auf der Resource CD oder unter <http://support.intel.com/support/motherboards/server/sb/cs-010770.htm>.

Consignes de sécurité

Lisez attention toutes les consignes de sécurité et les mises en garde indiquées dans ce document avant de suivre toute instruction. Consultez Intel Server Boards and Server Chassis Safety Information sur le Resource CD ou bien rendez-vous sur le site <http://support.intel.com/support/motherboards/server/sb/cs-010770.htm>.

Instrucciones de seguridad importantes

Lea todas las declaraciones de seguridad y precaución de este documento antes de realizar cualquiera de las instrucciones. Vea Intel Server Boards and Server Chassis Safety Information en el Resource CD y/o en <http://support.intel.com/support/motherboards/server/sb/cs-010770.htm>.

重要安全指导

在执行任何指令之前，请阅读本文档中的所有注意事项及安全声明。和/或 <http://support.intel.com/support/motherboards/server/sb/cs-010770.htm> 上的 *Intel Server Boards and Server Chassis Safety Information* (《Intel 服务器主板与服务器机箱安全信息》)。

Warnings

Heed safety instructions: Before working with your server product, whether you are using this guide or any other resource as a reference, pay close attention to the safety instructions. You must adhere to the assembly instructions in this guide to ensure and maintain compliance with existing product certifications and approvals. Use only the described, regulated components specified in this guide. Use of other products / components will void the UL listing and other regulatory approvals of the product and will most likely result in noncompliance with product regulations in the region(s) in which the product is sold.

System power on/off: The power button DOES NOT turn off the system AC power. To remove power from system, you must unplug the AC power cord from the wall outlet. Make sure the AC power cord is unplugged before you open the chassis, add, or remove any components.

Hazardous conditions, devices and cables: Hazardous electrical conditions may be present on power, telephone, and communication cables. Turn off the server and disconnect the power cord, telecommunications systems, networks, and modems attached to the server before opening it. Otherwise, personal injury or equipment damage can result.

Electrostatic discharge (ESD) and ESD protection: ESD can damage disk drives, boards, and other parts. We recommend that you perform all procedures in this chapter only at an ESD workstation. If one is not available, provide some ESD protection by wearing an antistatic wrist strap attached to chassis ground any unpainted metal surface on your server when handling parts.

ESD and handling boards: Always handle boards carefully. They can be extremely sensitive to ESD. Hold boards only by their edges. After removing a board from its protective wrapper or from the server, place the board component side up on a grounded, static free surface. Use a conductive foam pad if available but not the board wrapper. Do not slide board over any surface.

Installing or removing jumpers: A jumper is a small plastic encased conductor that slips over two jumper pins. Some jumpers have a small tab on top that you can grip with your fingertips or with a pair of fine needle nosed pliers. If your jumpers do not have such a tab, take care when using needle nosed pliers to remove or install a jumper; grip the narrow sides of the jumper with the pliers, never the wide sides. Gripping the wide sides can damage the contacts inside the jumper, causing intermittent problems with the function controlled by that jumper. Take care to grip with, but not squeeze, the pliers or other tool you use to remove a jumper, or you may bend or break the pins on the board.

Preface

About this Manual

Thank you for purchasing and using Intel® server products.

This manual is written for system technicians who are responsible for troubleshooting, upgrading, and managing the Intel® Server System SR9000MK4U. This document provides an overview of the features of the server system utilities, and instructions on how to install, setup, and manage the system. For the latest version of this manual, see <http://support.intel.com/support/motherboards/server/SR9000MK4U/>.

Manual Organization

Chapter 1 provides a brief overview of the chassis features for the Server System SR9000MK4U.

Chapter 2 provides an overview of the features of the boards used in the Server System SR9000MK4U.

In this chapter, you will find a list of the server board features, photos of the product, and product diagrams to help you identify components and their locations.

Chapter 3 provides instructions for adding and replacing components. Use this chapter for step-by-step instructions and diagrams for installing or replacing components such as the hard drives, memory, processor, fans, boards and other components.

Chapter 4 tells you how to install the system into a rack environment.

Chapter 5 provides instructions on using the utilities that are shipped with the board or that may be required to update the system. This includes how to navigate through the BIOS Setup screens, and how to clear the CMOS.

Chapter 6 provides troubleshooting information. In this chapter, you will find suggestions and steps to follow for performing troubleshooting activities to identify the source of a problem.

Appendices provide tables of POST codes, SEL codes, safety information, safety start-up warnings, and how to get help.

Product Accessories

You may need or want to purchase one or more of the following accessory items for your server:

Processor, memory DIMMs, hard drive, USB floppy drive, CD-ROM or DVD-ROM drive, RAID controller, operating system.

For information about which accessories, memory, processors, and third-party hardware have been tested and can be used with your board, and for ordering information for Intel products, see <http://support.intel.com/support/motherboards/server/SR9000MK4U/compat.htm>.

Additional Information and Software

If you need more information about this product or information about the accessories that can be used with this server board, use the following resources. These files are available at <http://support.intel.com/support/motherboards/server/SR9000MK4U/>

Unless otherwise indicated in the table below, once on this Web page, type the document or software name in the search field at the left side of the screen and select the option to search “This Product.”

Table 1. Additional Information and Software

For this information or software	Use this Document or Software
For in-depth technical information about this product, including BIOS settings and chipset information	<i>Intel® Server System SR9000MK4U Technical Product Specification</i>
If you just received this product and need to install it	<i>Intel® Server System SR9000MK4U Quick Start User's Guide</i> in the product box
Accessories or other Intel server products	Spares and Configuration Guide
Hardware (peripheral boards, adapter cards) and operating systems that have been tested with this product	Tested Hardware Operating Systems List
Processors that have been tested with this product	Supported Processors

Table 1. Additional Information and Software

For this information or software	Use this Document or Software
DIMMs that have been tested with this product	Tested Memory List
For drivers	Driver (for an extensive list of available drivers) Operating System Driver (for operating system drivers)
For firmware and BIOS updates, or for BIOS recovery	Firmware Updates
For diagnostics test software	Diagnostics

See also the Resource CD that came with your server system.

Powering the System On and Off

Powering On the System Power

1. Connect the power cables to AC input power connectors in the back of the system and to the outlet. If 100 - 110 VAC is used, both power supplies must be connected.
2. If peripheral devices are attached that need to be turned on first, power on these peripherals. See your peripheral guides for information.
3. Press the power button on the front panel. The green power LED will light.
4. Watch the fault LED on the front panel for any signs of trouble. See the troubleshooting information at the end of this manual for help if necessary.

Powering Off the System Power

1. If peripheral devices are attached that need to be turned off first, power off these peripherals. See your peripheral guides for information.
2. Press the power button on the front panel. The green power LED will turn off.

Note: *The system will force a power off if the power button is held down for four or more seconds. This method should be used only if the system has locked up. If the power is forced off, wake events, such as Wake-on-LAN, are disabled. The IPMI “Power Off” command functions the same way as a four-second button press. When the system power is forced off, either the power button or the IPMI “Power On” command must be used to power the system back on.*

Contents

Safety Information	iii
Important Safety Instructions	iii
Wichtige Sicherheitshinweise	iii
Consignes de sécurité	iii
Instrucciones de seguridad importantes	iii
Warnings	iv
Preface	vii
About this Manual	vii
Manual Organization	vii
Product Accessories	viii
Additional Information and Software	viii
Powering the System On and Off	x
Powering On the System Power	x
Powering Off the System Power	x
Chapter 1: Intel® Server System SR9000MK4U Chassis Overview	1
Chassis Description	2
External Chassis Features	3
Chassis Front	4
Chassis Rear	9
Internal Layout	11
Internal Chassis Features	12
Power Supply Subsystem	12
Cooling Subsystem	14
PCI Card Slot	15
Chapter 2: Intel® Server System SR9000MK4U Board Set Overview	17
Main Board	18
Configuration Restrictions	22
Processor Configurations	23
Memory Box Card	24
DIMM Configurations	25
Hard Drive Backplane	29
Hard Drive Population	30
Front Panel Board	30
Chapter 3: Installing and Removing Components	33
Tools Needed	33
Installing and Removing the Front Bezel	34
Removing the Front Bezel	34

Installing the Front Bezel	35
Installing and Removing the Top Cover	36
Removing the Top Cover	36
Installing the Top Cover	37
Installing and Removing a Hard Drive	37
Installing a Hard Drive	38
Removing a Hard Drive	40
Hot-swapping a Hard Drive	42
Installing and Removing a Memory Box	42
Installing a Memory Box	43
Removing a Memory Box	45
Hot-swapping a Memory Box	46
Installing and Removing DIMMs	48
DIMM Installation Guidelines	48
Installing DIMMs	49
Removing DIMMs	50
Installing and Removing an Optical Drive	51
Installing an Optical Drive	51
Removing the Optical Drive	53
Installing and Removing a Fan	55
Installing a Fan	55
Removing a Fan	57
Hot-swapping a Fan	58
Installing and Removing a PCI Card	59
Installing a PCI Card	59
Removing a PCI Card	63
Hot-Plugging a PCI Card	67
Installing and Removing a Power Supply	68
Installing a Power Supply	68
Removing a Power Supply	70
Hot-swapping a Power Supply	73
Installing and Removing the Front Control Panel and Optical Drive Assembly	74
Removing the Front Control Panel and Optical Drive Assembly	74
Installing the Front Control Panel and Optical Drive Assembly	75
Installing and Removing the Power Supply Box	76
Removing the Power Supply Box	76
Installing the Power Supply Box	80
Installing and Removing the Power Supply Support	83
Removing the Power Supply Support	83
Installing the Power Supply Support	85
Installing and Removing the Hard Drive Backplane Cover	87
Removing the Hard Drive Backplane Cover	87
Installing the Hard Drive Backplane Cover	88
Installing and Removing the KVM Card	89

Removing the KVM Card	89
Installing the KVM Card	90
Installing and Removing the PCI Card Divider	91
Removing the PCI Card Divider	91
Installing the PCI Card Divider	93
Installing and Removing the Air Flow Guide	95
Removing the Air Flow Guide	95
Installing the Air Flow Guide	97
Installing and Removing the Fan Box	98
Removing the Fan Box	98
Installing the Fan Box	101
Installing and Removing the Hard Drive Backplane	103
Removing the Hard Drive Backplane	103
Installing the Hard Drive Backplane	107
Installing and Removing a Processor	110
Removing a Processor	111
Installing the Processor	113
Disassembling a Processor Assembly	122
Installing and Removing the Mounting Plate	125
Removing the Mounting Plate	125
Installing the Mounting Plate	127
Installing and Removing Chassis Handles	129
Installing Chassis Handles	129
Removing Chassis Handles	129
Chapter 4: Configuration Software and Utilities	131
The Extensible Firmware Interface (EFI) Boot Manager	131
The Extensible Firmware Interface (EFI) Shell	134
LSI* SAS Utility	137
Formatting a Hard Drive	137
Clearing the CMOS	140
Upgrading the Firmware	140
How to Use FWUPDATE	142
Execution Screen	144
Using System Setup	145
Starting Setup	145
Recording Your Setup Settings	145
Navigating Setup Utility Screens	146
Primary Screens	146
Configuring Serial-Over LAN	151
Chapter 5: Troubleshooting	153
Initial Troubleshooting Steps	153
Collecting System State Information	156
How to Read the POST Codes	159

How to Use Selview to Read the System Event Log	160
How to Collect System and Error Logs	160
Taking Corrective Action	162
Appendix A: Console Setup	163
On-board VGA	163
Serial Console	165
Appendix B: Cabling	167
Working with Ribbon Cables	167
Cable Connections	168
Appendix C: POST Codes	171
Appendix D: Installation/Assembly Safety Instructions	181
English	181
Deutsch	183
Français	185
Español	187
Italiano	189
Appendix E: Safety Information	193
Warning Labels	193
English	195
Server Safety Information	195
Safety Warnings and Cautions	196
Intended Application Uses	196
Site Selection	197
Equipment Handling Practices	197
Power and Electrical Warnings	198
System Access Warnings	199
Rack Mount Warnings	200
Electrostatic Discharge (ESD)	200
Other Hazards	201
Deutsch	202
Sicherheitshinweise für den Server	202
Sicherheitshinweise und Vorsichtsmaßnahmen	202
Zielbenutzer der Anwendung	203
Standortauswahl	203
Handhabung von Geräten	204
Warnungen zu Netzspannung und Elektrizität	204
Warnhinweise für den Systemzugang	205
Warnhinweise für Racks	206
Elektrostatische Entladungen (ESD)	206
Andere Gefahren	207
Français	208

Consignes de sécurité sur le serveur	208
Sécurité: avertissements et mises en garde	208
Domaines d'utilisation prévus	209
Sélection d'un emplacement	209
Pratiques de manipulation de l'équipement	209
Alimentation et avertissements en matière d'électricité	210
Avvertissements sur l'accès au système	211
Avvertissements sur le montage en rack	212
Décharges électrostatiques (ESD)	212
Autres risques	212
Español	214
Información de seguridad del servidor	214
Advertencias y precauciones sobre seguridad	214
Aplicaciones y usos previstos	215
Selección de la ubicación	215
Manipulación del equipo	215
Advertencias de alimentación y eléctricas	216
Advertencias el acceso al sistema	217
Advertencias sobre el montaje en bastidor	218
Descarga electrostática (ESD)	218
Appendix F: Getting Help	225
World Wide Web	225
Telephone	225
Appendix G: Regulatory and Compliance Information	229
Product Regulatory Compliance	229
Product Safety Compliance	229
Product EMC Compliance - Class A Compliance	230
Certifications / Registrations / Declarations	230
Electromagnetic Compatibility Notices	231
FCC Verification Statement (USA)	231
Industry Canada (ICES-003)	232
Europe (CE Declaration of Conformity)	232
VCCI (Japan)	232
BSMI (Taiwan)	233
RRL (Korea)	233
CNCA (CCC China)	233
Regulated Specified Components	234
Restriction of Hazardous Substances (RoHS) Compliance	235
End of Life / Product Recycling	235

List of Figures

Figure 1. Intel® Server System SR9000MK4U Three Dimensional View	1
Figure 2. Chassis Front View	4
Figure 3. Front Panel Controls and Indicators	5
Figure 4. Optical Drive Bracket with Drive Installed	6
Figure 5. Hard Drive Carrier	6
Figure 6. Memory Box Front View	8
Figure 7. Chassis Rear View	9
Figure 8. Open System, Top View	11
Figure 9. Power Supply Indicators	13
Figure 10. Cooling Fan Indicator	14
Figure 11. PCI Card Slot Indicator	15
Figure 12. Block Diagram	17
Figure 13. Main Board Layout	18
Figure 14. Processor Locations	23
Figure 15. Memory Box Card Layout	24
Figure 16. DIMM Locations (Top View of Memory Box)	25
Figure 17. Memory Upgrade Path	28
Figure 18. Hard Drive Backplane Top View	29
Figure 19. Hard Drive Backplane Bottom View	29
Figure 20. Front Panel Board Layout	30
Figure 21. Removing the Front Bezel	34
Figure 22. Installing the Front Bezel	35
Figure 23. Removing the Top Cover	36
Figure 24. Installing the Top Cover	37
Figure 25. Pulling Down on the Hard Drive Carrier Lever	38
Figure 26. Mounting a Hard Drive	39
Figure 27. Installing a Hard Drive	39
Figure 28. Pulling Down on the Hard Drive Carrier Lever	40
Figure 29. Unmounting a Hard Drive	41
Figure 30. Hard Drive LED Indicators	42
Figure 31. Removing the Memory Box Filler Panel	43
Figure 32. Installing the Memory Box	44
Figure 33. Memory Box Installed and Locked into Place	44
Figure 34. Removing the Memory Box	45
Figure 35. Memory Box Front View	46
Figure 36. Four-DIMM Installation Pattern	48
Figure 37. Eight-DIMM Installation Pattern	48
Figure 38. Locating the Optical Drive Installation Position	51
Figure 39. Removing the Optical Drive Filler Panel	51
Figure 40. Attaching the Optical Drive to the Bracket	52
Figure 41. Installing of Optical Drive	52
Figure 42. Locating the Optical Drive Installation Position	53

Figure 43. Removing Optical Drive from Server	53
Figure 44. Removing the Optical Drive from the Bracket.....	54
Figure 45. Locating the Fans	55
Figure 46. Installing a Fan	56
Figure 47. Locating the Fans	57
Figure 48. Removing a Fan	57
Figure 49. Fan Fault LED.....	58
Figure 50. Opening the PCI Caution Plate.....	59
Figure 51. Unlocking a PCI Card Lock.....	60
Figure 52. Removing a PCI Slot Cover.....	60
Figure 53. PCI Tail Lock	61
Figure 54. Installing a PCI Card.....	61
Figure 55. Locking a PCI Card into Place.....	62
Figure 56. Closing the PCI Caution Plate	62
Figure 57. Opening a PCI Caution Plate.....	63
Figure 58. Unlocking a PCI Card Lock.....	64
Figure 59. Releasing the PCI Card from the Tail Lock	64
Figure 60. Installing a PCI Slot Cover.....	65
Figure 61. Locking a PCI Card or Slot Cover into Place.....	65
Figure 62. Closing the PCI Caution Plate	66
Figure 63. Locating the Lens Switch and PCI Card LED	67
Figure 64. Removing a Power Supply Filler.....	69
Figure 65. Installing a Power Supply	69
Figure 66. Locking the Power Supply into Place	70
Figure 67. Opening the Power Supply Levers	71
Figure 68. Removing the Power Supply	71
Figure 69. Installing a Power Supply Filler.....	72
Figure 70. Power Supply LED Indicators.....	73
Figure 71. Removing the Front Control Panel and Optical Drive Assembly	74
Figure 72. Installing the Front Control Panel and Optical Drive Assembly	75
Figure 73. Locating the CPU1 / CPU2 MVR Connection.....	77
Figure 74. Disconnecting the IDE and SATA Cables.....	77
Figure 75. Loosening the Exterior Captive Screws.....	78
Figure 76. Loosening the Interior Captive Screws.....	78
Figure 77. Lifting the Power Supply Box from System.....	79
Figure 78. Inserting the Rear of Power Supply Box.....	80
Figure 79. Setting the Front of the Power Supply Box into Place.....	80
Figure 80. Tightening the Internal Power Supply Box Screws.....	81
Figure 81. Tightening the External Power Supply Box Screws.....	81
Figure 82. Locating the CPU1 / CPU2 MVR Connection.....	82
Figure 83. Connecting the IDE and SATA Cables.....	82
Figure 84. Loosening the Power Supply Support Captive Screws	84
Figure 85. Lifting the Power Supply Support from System	84
Figure 86. Setting the Power Supply Support into Place	85
Figure 87. Tightening the Power Supply Support Screws	86
Figure 88. Removing the Hard Drive Backplane Cover	87
Figure 89. Installing the Hard Drive Backplane Cover	88

Figure 90. Checking the Backplane Cover Latches	89
Figure 91. Locating the KVM Card	90
Figure 92. Removing the PCI Card Divider	92
Figure 93. Installing the PCI Divider.....	93
Figure 94. Locating the CPU1 / CPU2 MVR Connection	94
Figure 95. Removing the Air Flow Guide	96
Figure 96. Installing the Air Flow Guide	97
Figure 97. Loosening the Exterior Screws	99
Figure 98. Loosening the Interior Screws.....	100
Figure 99. Lifting the Fan Box from the System	100
Figure 100. Installing the Fan Box.....	101
Figure 101. Tightening the Internal Fan Box Screws	102
Figure 102. Tighten the External Fan Box Screws.....	102
Figure 103. Removing the Hard Drive Backplane from System.....	106
Figure 104. Installing the Hard Drive Backplane	107
Figure 105. Attaching the Hard Drive Backplane to the System	108
Figure 106. Processor Assembly Components	110
Figure 107. Removing the MVR Handles.....	112
Figure 108. Loosening the MVR Screws.....	112
Figure 109. Exposing the Thermal Interface Material	114
Figure 110. Installing the Pin Shroud over the Processor	115
Figure 111. Installing the Spring Clip	115
Figure 112. Setting the Processor over the Heat Sink	116
Figure 113. Securing the Processor to the Heat Sink	116
Figure 114. Installing the Bolster Plate onto the Processor	117
Figure 115. Making Sure the Processor Socket is Unlocked	117
Figure 116. Setting the Processor Assembly into Place over the Processor Socket	118
Figure 117. Attaching the Processor and Heat Sink to the Main Board	118
Figure 118. Removing the Protective Cover from the LGA Terminal	119
Figure 119. Setting the MVR into Place on the Processor Assembly	119
Figure 120. Attaching the MVR to the Processor Assembly	120
Figure 121. Installing the Handles onto the MVR.....	120
Figure 122. Installing the LGA Terminal Cover	122
Figure 123. Loosening the Heat Sink Screws	122
Figure 124. Removing the Bolster Plate from the Processor	123
Figure 125. Removing the Processor from the Heatsink.....	123
Figure 126. Removing the Spring Clip	124
Figure 127. Removing the Pin Shroud from the Processor.....	124
Figure 128. Lifting the Mounting Plate from the System	126
Figure 129. Setting the Mounting Plate into Place	127
Figure 130. Attaching the Chassis Handles	129
Figure 131. Firmware Update Block Diagram	141
Figure 132. FWUPDATE File Path Example.....	142
Figure 133. FWUPDATE Execution Screen.....	144
Figure 134. State Transition Diagram	156
Figure 135. Location of POST Code LED	159
Figure 136. Connections Near Power Supply Box and PCI Card Divider	168

Figure 137. SATA Connections on Hard Drive Backplane	168
Figure 138. IDE Connection and Cable Routing.....	169
Figure 139. MVR Connectors	169
Figure 140. Caution: Memory Box Contains Hot Components	193
Figure 141. Caution: Server System is Heavy	194
Figure 142. Caution: System Contains Areas of High Voltage	194
Figure 143. Warning: Voltage on Non Hot-swap Power Supply	195
Figure 144. Warning: Voltage on Hot-swap Power Supply.....	195

List of Tables

Table 1. Additional Information and Software	viii
Table 2. Server Physical Specifications	1
Table 3. Chassis Feature Summary	2
Table 4. SAS Hard Drive LED Details	7
Table 5. NIC LEDs	10
Table 6. 1390 W Power Supply Configuration	12
Table 7. Main Board Components	19
Table 8. Main Board External I/O Connectors	21
Table 9. Main Board Internal I/O Connectors	21
Table 10. Configuration Restrictions	22
Table 11. Supported Processor Configuration	23
Table 12. Memory Box Card Components	24
Table 13. Memory Box Card Connectors	24
Table 14. Memory Operational Modes	26
Table 15. Hard Drive Backplane Connectors	29
Table 16. Front Panel Board Components	30
Table 17. Front Panel Board Connectors	31
Table 18. Loosening the Hard Drive Backplane Screws	105
Table 19. Boot Maintenance Menu Options	132
Table 20. EFI Shell Commands	135
Table 21. Command Line Description	143
Table 22. Using Setup Screens	146
Table 23. Primary Setup Screens	146
Table 24. Main Setup Screen	147
Table 25. Processor Screen	148
Table 26. Memory Screen	148
Table 27. Devices Screen	149
Table 28. Server Management Screen	150
Table 29. COM1 Console Redirection	150
Table 30. Troubleshooting Guide	153
Table 31. POST Codes Generated by the BMC and Logged at the Seven Segment LED ...	171
Table 32. POST Codes Generated by SAL and Logged at the Seven Segment LED	177
Table 33. Error POST Codes Generated by SAL	179

1 Intel® Server System SR9000MK4U Chassis Overview

The Intel® Server System SR9000MK4U as shown in Figure 1 is a compact, high-density rack-mount server system with support for up to four Intel® Itanium® 2 processors and 256-GB DDR2 SDRAM memory. The system is based on the Hitachi CF-3e board set and the Hitachi CF-3e chipset.

The system supports hot-plug PCI-X* and PCI-Express* add-in cards; hot-swap, redundant power supply modules; hot-swap redundant cooling fans; and hot-swap hard drives. The system supports symmetric multiprocessing (SMP) and a variety of operating systems. Table 2 provides an overview of the server system's physical characteristics.

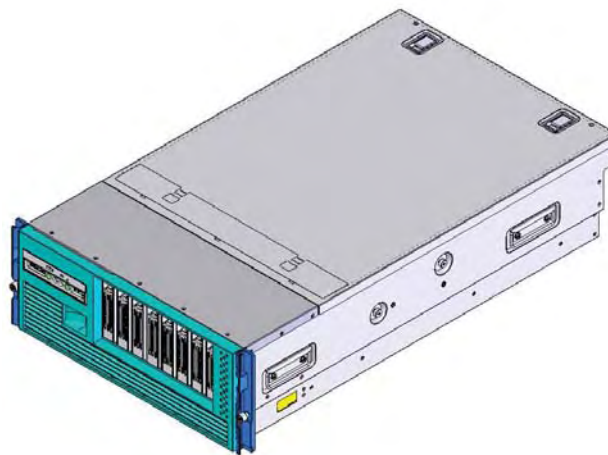

AF001081

Figure 1. Intel® Server System SR9000MK4U Three Dimensional View

Table 2. Server Physical Specifications

Characteristics	Specifications
Height	176 mm (6.9 inches)
Width	441 mm (17.3 inches)
Depth	765 mm (30.1 inches)
Weight	Base: 21 kg (46.3 lbs), Max: 48 kg (105.8 lbs)
Heat Dissipation	1390 W

Chassis Description

Features are outlined in Table 3.

Table 3. Chassis Feature Summary

Feature	Comment
Server Configuration	<ul style="list-style-type: none"> • Stand-alone system including external I/O PCI slots and disk expansion as needs grow • Support for Intel® Itanium® 2 processors • Support for 533 MHz Front Side Bus (FSB) • Support for Double Data Rate-2 (DDR-2) 533 Synchronous Dynamic Random Access Memory (SDRAM) • Support for PCI Express* x4/x8/x16
Expansion and Servicing	<ul style="list-style-type: none"> • Up to four Intel® Itanium® 2 processors • Up to 32 DIMM sockets with max 256 GB memory capacity • Two 64-bit PCI-X* slots • Two x8 PCI-Express* slots • Two x16 PCI-Express slots • Up to eight hot-swappable 3.5-inch SAS 3G hard drives with front/external access • Two hot-swap 1390 W power supplies in a redundant power cords when using 200-240 VAC configuration with redundant power cords (one cord per power supply). If 100 - 110 VAC is used, both power supplies must be connected for the server system to operate, and redundancy is not available. • Six top access hot-swap system fans in a redundant (5+1) configuration • Dockable slimline optical drive • Status indicator LEDs
Management	<ul style="list-style-type: none"> • Intelligent Platform Management Interface (IPMI) 2.0 compliant • Remote management across the LAN • Remote diagnostics support across the LAN • Remote KVM across the LAN • Remote optical drive access across the LAN
Upgrades	<ul style="list-style-type: none"> • Field upgradeable to the next generation Intel® Itanium® processor family • Multi-generational chassis

External Chassis Features

System control buttons and indicators are located in several places on the chassis:

- Chassis front
 - Front panel: Front panel switches and LEDs
 - Optical drive bay
 - Hot-swap hard drive bay: hard drive LEDs
 - Memory box: Memory box serviceability LEDs
- Chassis rear
 - Power supplies and AC inputs
 - PCI slots
 - IO ports
 - Identification switch
- Chassis top
 - Power supply indicators
 - Cooling fan
 - PCI hot plug

Chassis Front

Figure 2 shows the front view of the chassis with the snap-on bezel in place. The bezel provides access to the optical drive, front panel controls, and the hot-swap hard drives. The bezel must be removed to access the memory boxes.

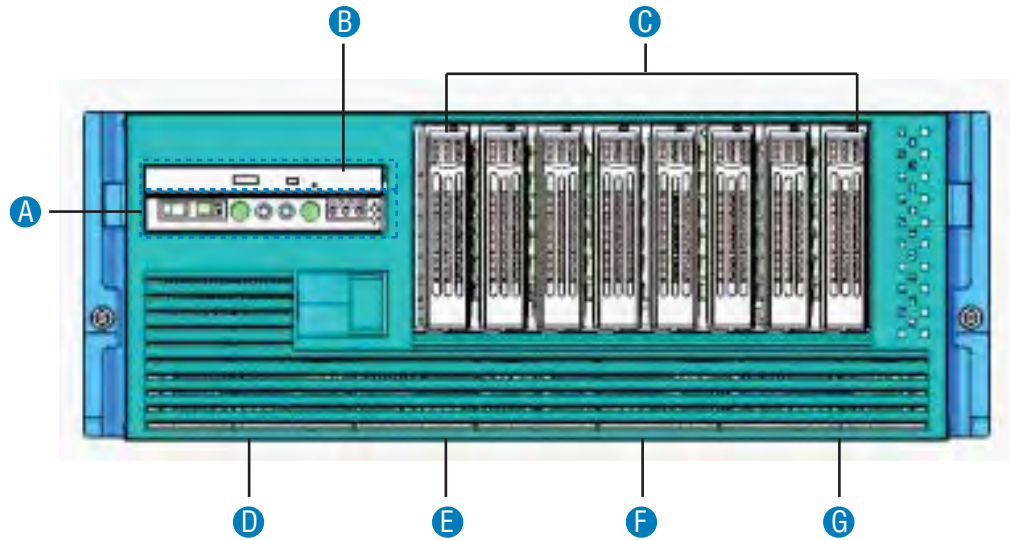

AF001082

A. Front Panel, see "Front Panel"	E. Memory box 1
B. Optical Drive	F. Memory box 2
C. Hard Drives, HDD0 - HDD7 from left to right	G. Memory box 3
D. Memory box 0	

Figure 2. Chassis Front View

Front Panel

The front panel is located below the slimline optical drive on the left-side of the chassis front. The front panel provides buttons and status indicator LEDs. Figure 3 shows the control buttons and status indicators on the front panel.

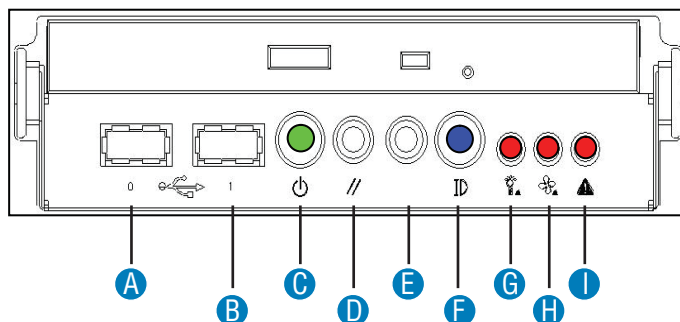

AF001083

<p>A. USB Port 0, USB 1.1. The port is shut down in case of an over-current. To recover, power down server and then power it back on.</p>	<p>F. Identification button and blue ID LED. Button toggles state of LED between on and off.</p> <ul style="list-style-type: none"> – Blue on: Identifies server. – Blue blink: CMOS being cleared or FWH recovery in process. For instructions on how to clear the CMOS, see “Clearing the CMOS” on page 140. – Off: System not identified, CMOS not being cleared, FWH recovery not in process.
<p>B. USB Port 1, USB 1.1. The port is shut down in case of an over-current. To recover, power down server and then power it back on.</p>	<p>G. Power fault LED:</p> <ul style="list-style-type: none"> – Orange on: Critical, non-recoverable power fault detected. – Orange blink: Non-critical power fault detected. – Off: No power fault detected.
<p>C. Power button and power LED.</p> <ul style="list-style-type: none"> – Green on: ACPI S0 state. – Green blink: System is powering down. – LED off: ACPI S5 state. <p>For information about power the system on and off, see “Powering the System On and Off” on page x.</p>	<p>H. Cooling fault LED:</p> <ul style="list-style-type: none"> – Orange on: Critical non-recoverable cooling fault detected. – Orange blink: Non-critical cooling fault detected. – Off: No cooling fault detected by the BMC.
<p>D. Reset button: Resets the system.</p>	<p>I. General fault LED:</p> <ul style="list-style-type: none"> – Orange on: Critical, non-recoverable fault other than power or cooling fault detected. – Orange blink: Non-critical fault other than power or cooling fault detected. – Off: No general fault detected.
<p>E. System diagnostic interrupt (SDINT) button: Asserts INIT to system.</p>	

Figure 3. Front Panel Controls and Indicators

Optical Drive Bay

The slim-line optical drive (DVD-ROM / CD-ROM drive) is inserted from the front of the optical drive bay. The system power must be turned off to remove or install this drive.

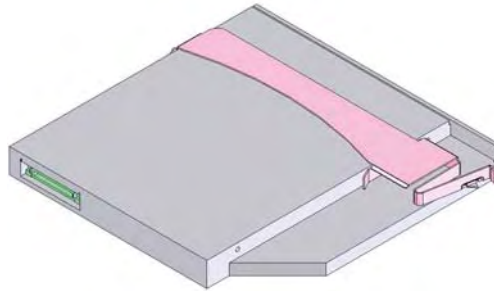

AF001084

Figure 4. Optical Drive Bracket with Drive Installed

Note: Intel validates specific DVD-ROM / CD-ROM drives. See the Intel® Server System SR9000MK4U Tested Hardware and Operating System List” for a list of these drives available.

Hot-swap Hard Drive Bay

The hot-swap hard drive carrier, shown in Figure 5 is designed to support 15,000-RPM or slower SAS3G technology hard drives.

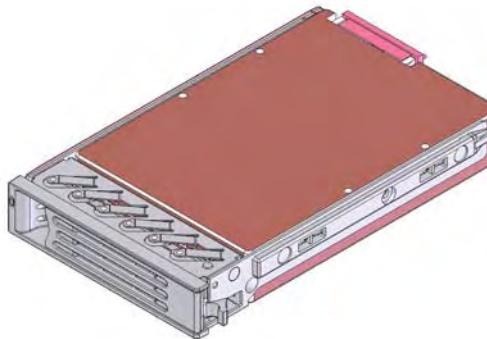

AF001085

Figure 5. Hard Drive Carrier

The hard drive carriers contain light-pipes that allow dual-color LED indicators to display through the bezel. The hard drive status is described in Table 4.

Table 4. SAS Hard Drive LED Details

LED Color	State	Description
Green	On	Activity
	4 Hz blink	Locate
	1 Hz blink	Rebuild
Red	On	Error
Red / Green / Off	Blink	Hard drive insert Power on reset with or without hard drive

Notes:

- *To test the hard drive LEDs, do the following:*
 - *Install a hard drive.*
 - *Power on the system.*
 - *Watch for the LED status to change. The red LED should be on for 0.5 seconds, then the green turns on and remains on.*
- *Intel validates specific hard drive types in the Server System SR9000MK4U. See the Intel® Server System SR9000MK4U Tested Hardware and Operating System List for a list of the drives supported.*

Memory Box

In memory mirror mode, memory box 0 is paired with memory box 1. Memory box 2 is paired with memory box 3. When mirroring mode is used, either of the memory boxes with a pair can be hot-swapped.

Figure 6 shows the front view of the memory box.

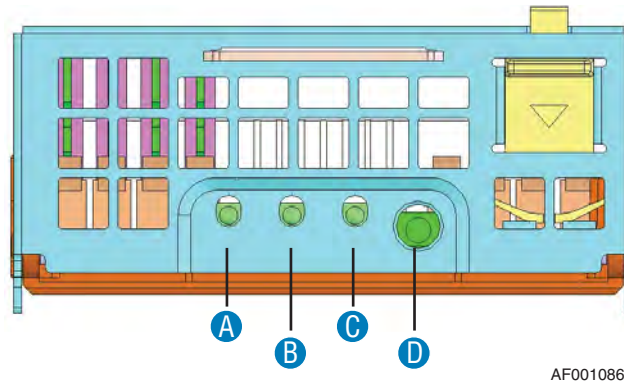

Callout	LED	LED State	Description
A	Memory Box Mirror LED	Green on	The memory box is operating in mirror mode.
		Off	The memory box is not operating in mirror mode.
B	Memory Box Power LED	Green on	The memory box is powered on.
		Off	The memory box is powered off.
C	Memory Box Attention LED	Orange on	An error has been detected in the memory box.
		Off	No error has been detected on the memory box or the memory box is powered off.
D	No LED	N/A	Hot-swap button. Press this button to initiate a hot-swap process.

Figure 6. Memory Box Front View

Chassis Rear

Figure 7 shows the features found on the rear panel.

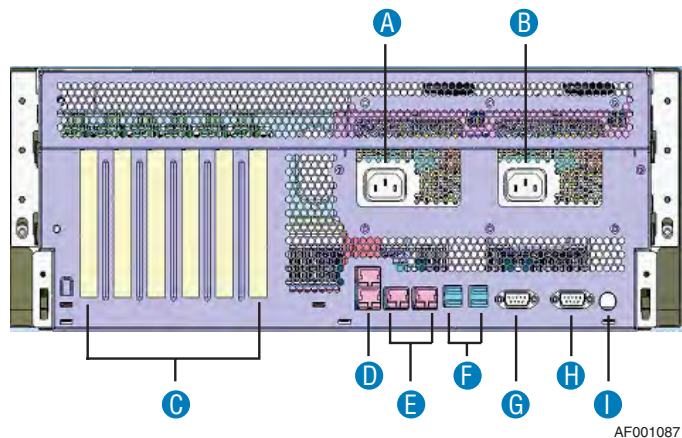

AF001087

A	AC input power connectors	
B	AC input power connectors	
C	PCI Slots	All slots support hot-plug PCI add-in cards. From left to right: <ul style="list-style-type: none"> – Slot 6: 133 MHz, 64-bit PCI-X*, full length – Slot 5: PCI-Express* x 16, half length – Slot 4: PCI-Express x 8, half length – Slot 3: 133 MHz, 64-bit PCI-X, half length – Slot 2: PCI-Express x 16, half length – Slot 1: PCI-Express x 8, half length
D	Dual Gb Ethernet ports	RJ45 connectors. See Table 5 for LED information. <ul style="list-style-type: none"> – GbE1: top – GbE0: bottom
E	100 Mb Ethernet ports	RJ45 connectors. See Table 5 for LED information. <ul style="list-style-type: none"> – Ether0: left. Management LAN port – Ether1: right. KVM LAN port
F	Four USB ports	4-pin connectors: <ul style="list-style-type: none"> – Top left: RUSB3 – Bottom left: RUSB2 – Top right: RUSB1 – Bottom right: RUSB0
G	Video port	Standard VGA compatible, 15-pin connector
H	Serial port	9-pin RS-232 connector
I	Identification Button	Toggles chassis ID LED on/off.

Figure 7. Chassis Rear View

Table 5. NIC LEDs

Item	LED	Color	State	Description
Gigabit Ether, ports GbE1 and GbE0	ACT/LNK (right LED)	Green	On	Link
		Green	Blink	Active
		None	Off	No link
	SPEED (left LED)	Yellow	On	1000
		Green	On	100
		None	Off	10
Fast Ether (Management LAN, KVM LAN), ports Ether0 and Ether1	ACT/LNK (right LED)	Green	On	Link
		Green	Blink	Active
		None	Off	No link
	SPEED (left LED)	Green	On	100
		None	Off	10

Internal Layout

The following diagram shows the location of components inside of the server system.

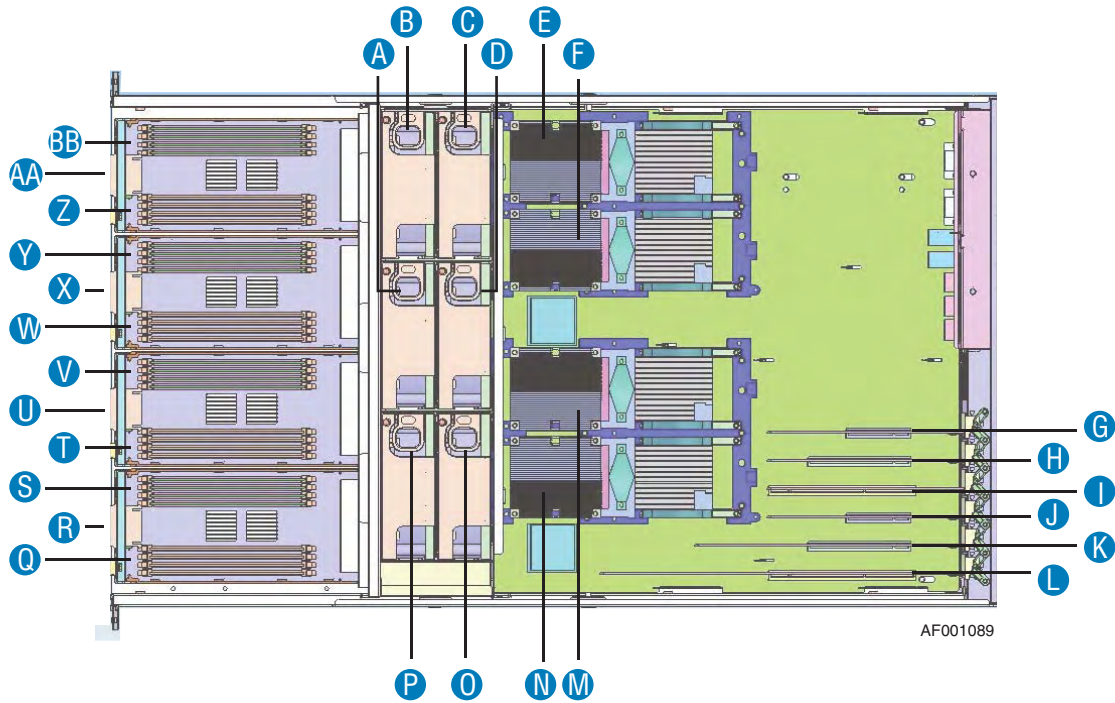

A. System Fan 2	K. PCI-Express, x16, Slot 5	U. Memory Box 2
B. System Fan 0	L. PCI-X, Slot 6	V. DIMM Sockets
C. System Fan 1	M. Processor 2	W. DIMM Sockets
D. System Fan 3	N. Processor 3	X. Memory Box 1
E. Processor 0	O. System Fan 5	Y. DIMM Sockets
F. Processor 1	P. System Fan 4	Z. DIMM Sockets
G. PCI-Express, x8, Slot 1	Q. DIMM Sockets	AA. Memory Box 0
H. PCI Express, x 16, Slot 2	R. Memory Box 3	BB. DIMM Sockets
I. PCI-X, Slot 3	S. DIMM Sockets	
J. PCI-Express, x8, Slot 4	T. DIMM Sockets	

Figure 8. Open System, Top View

Internal Chassis Features

Power Supply Subsystem

The 12 V hot-swap power supply modules are rated at 1390 W over an input range of 200 - 240 VAC, and at 990 W over an input range of 100-127 VAC.

The power supply module has two outputs, that is, +12 V and +5 Vsb. The standby voltages +5 Vsb is active anytime AC input power is applied to the power supply.

The power supply module is connected to the main board directly and can be used in 1+1 redundant mode.

Note: *Two power supplies must be installed and plugged in when a 110 V outlet is used. Hot-swapping and redundancy are not available under this condition.*

One power supply can be used when it is connected to a 220 VAC outlet. Under this condition, redundancy is available and a power supply can be hot-swapped if necessary.

Table 6. 1390 W Power Supply Configuration

AC Input	Current See Note	Redundancy	Hot-swap	Remarks
200-240 V	9.5 A	Supported	Supported	Restriction of loading is needed. Two power supplies must be installed to enable redundancy and hot-swap.
100-127 V	12 A	Not supported	Not supported	Restriction of loading is needed. Two power supplies must be installed to operate the server system.

Note: *This value is applied to one power supply.*

Each power supply contains three LEDs on the top surface. The LED locations and descriptions are as follows.

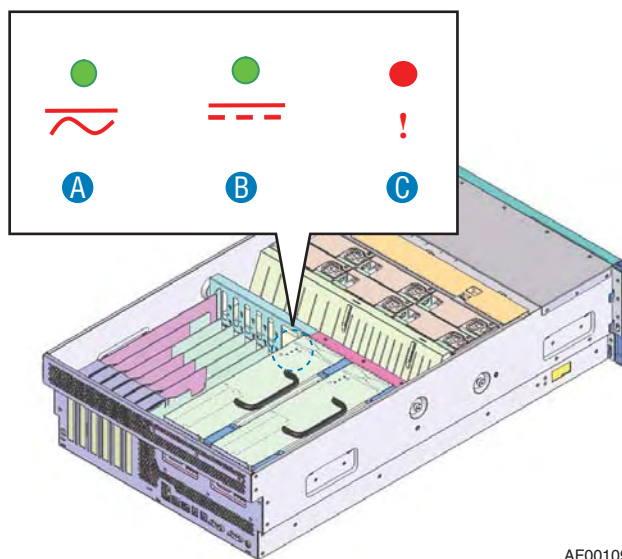

AF001090

A	Input Good LED	Indicates input power is good, when this LED (green) is on.
B	DC Output Good LED	Indicates output power is good, when this LED (green) is on.
C	Fault LED	Indicates a fault with the power supply.

Figure 9. Power Supply Indicators

Cooling Subsystem

The cabinet inlets have hot-swappable, 5+1 redundant fans for cooling.

120 mm x 38 mm fans are used. They provide enough airflow to cool the system components, processors, memory and chipset, even if one of the six fans fails. The fans are located across the center of the cabinet. The hard drives and DVD-ROM drive are cooled by suction. Components on main board, processor and chipset are cooled by the air flow through the air duct.

The power supply module has non-redundant fans in it for cooling the power supply.

Caution: *The chassis top cover must be installed for proper system cooling. Additionally, cooling fans must be hot-swapped within two minutes. This time period applies only to the time that the cooling fan is physically removed, not from the time of failure.*

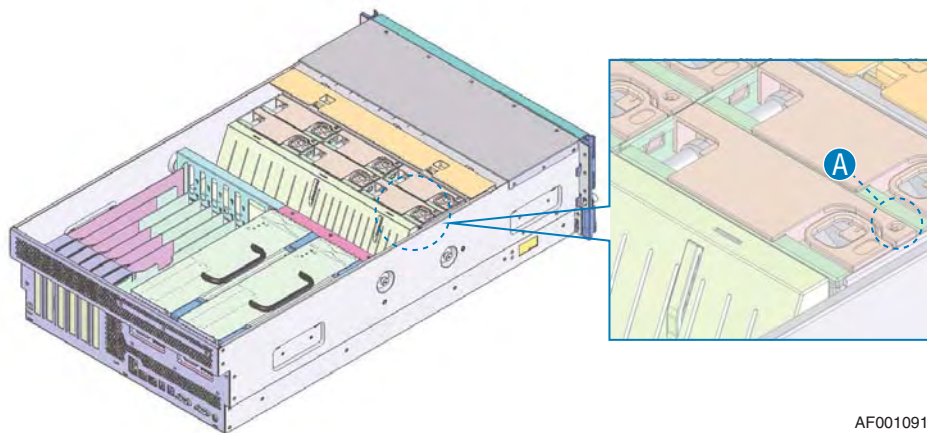

A	Cooling Fan LED	Indicates fan is working normally when LED (green) is on Indicates fan has a fault when LED is off.
---	-----------------	--------------------------------------------------------------------------------------------------------

Figure 10. Cooling Fan Indicator

PCI Card Slot

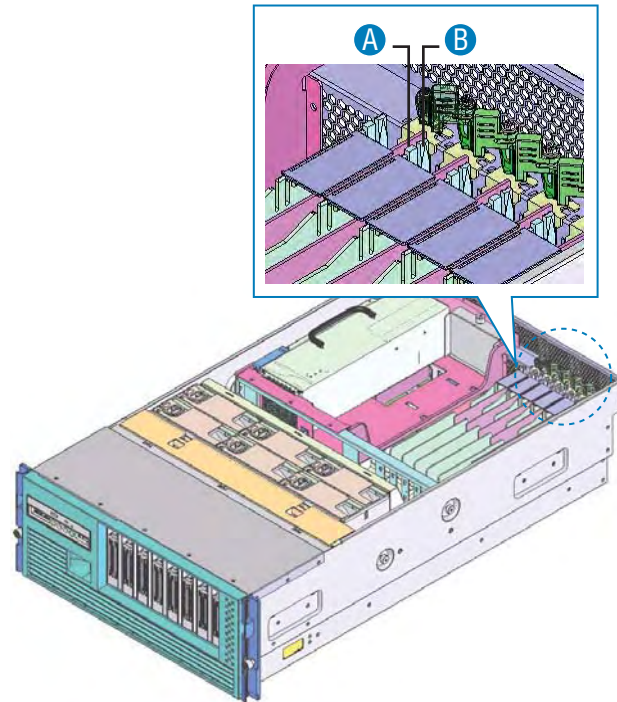

AF001092

A	Power LED	Indicates PCI slot status is active.
B	Attention LED and lens switch	Indicates error, when this yellow LED is on. The lens switch is used for hot installs / removals.

Figure 11. PCI Card Slot Indicator

2 Intel® Server System SR9000MK4U Board Set Overview

The board set for the Intel® Server System SR9000MK4U consists of one main board, four memory box cards (installed in the memory boxes), one hard drive backplane and one front panel board. The block diagram of Intel® Server System SR9000MK4U is as follows. The connection points between the main board and the front panel board are shown by the green circled numbers.

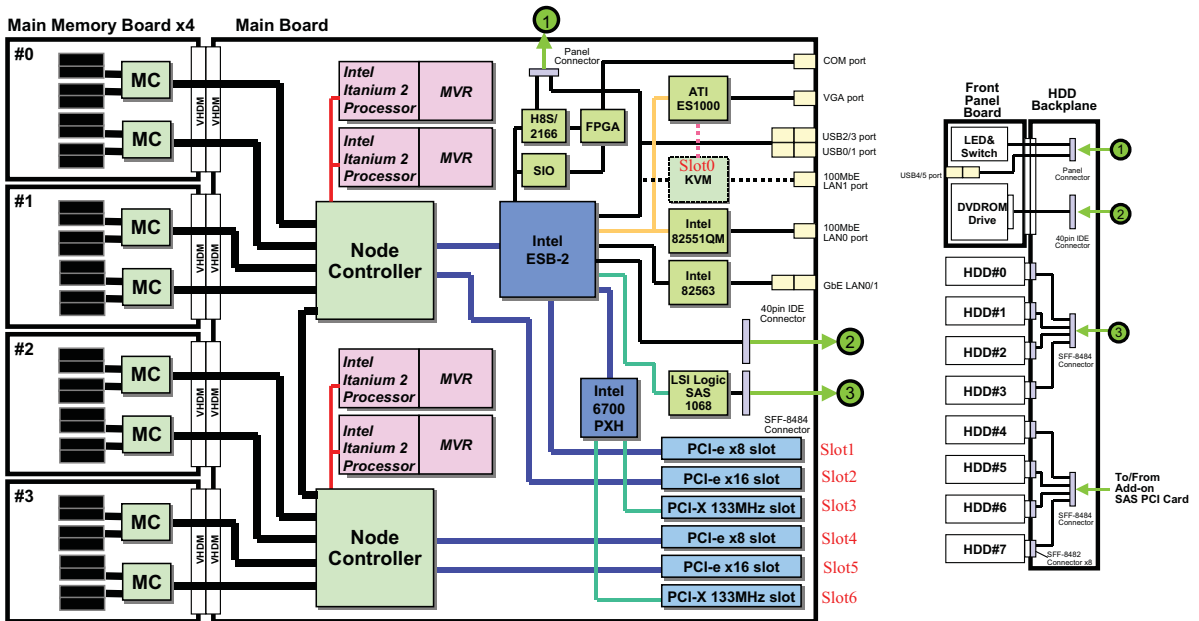

AF001093

Figure 12. Block Diagram

Main Board

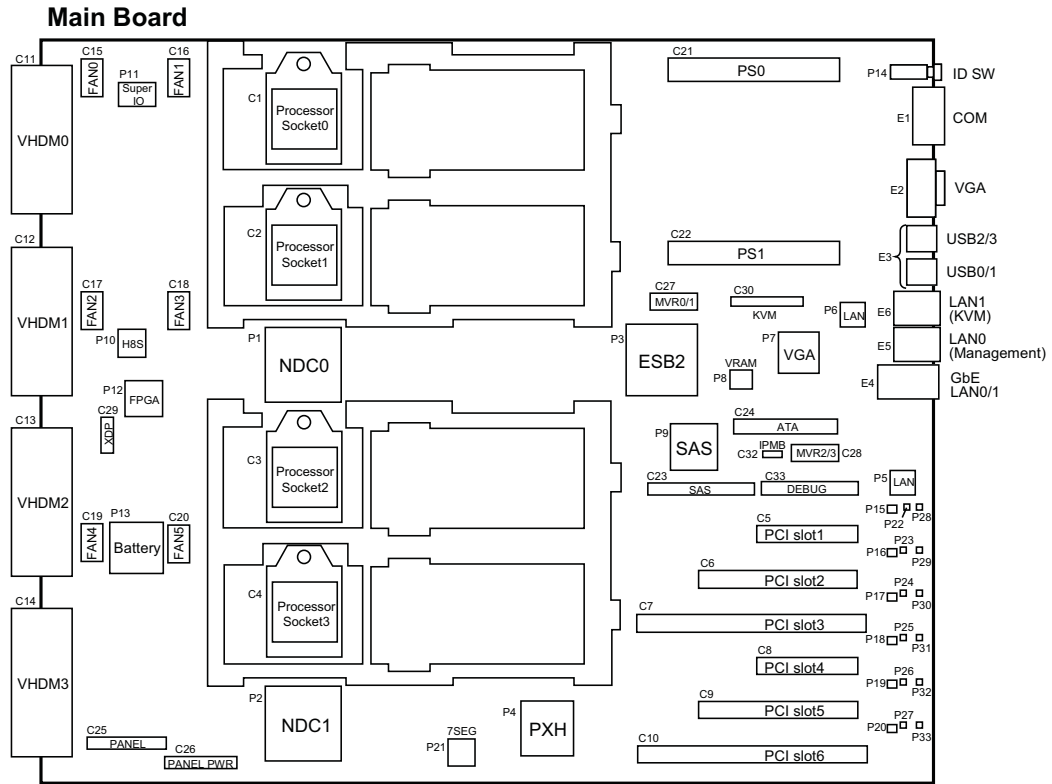

AF001095

Figure 13. Main Board Layout

Table 7. Main Board Components

Board Location	Component	Description
P1/P2	Hitachi* NDC	<p>Node Controller:</p> <ul style="list-style-type: none"> • One Front Side Bus <ul style="list-style-type: none"> – 533/667 MHz FSB support – Two processors per bus • Four interfaces connecting to the memory controller • Three x8 PCI Express* ports • Proprietary high-speed interface to link between two node controllers • Optimized design for 667 MHz FSB to achieve low memory access latency • Broadcast-based cache coherence control to minimize snoop transaction
P3	Intel® ESB2	Enterprise South Bridge
P4	Intel® 6700PXH	<p>64-bit PCI Hub:</p> <ul style="list-style-type: none"> • PCI bridging functions between the PCI Express interface and the PCI Bus • One PCI Express* interface (primary bus) • x8 and x4 modes operation • Maximum 2 GB/s in each direction simultaneously • Two PCI / PCI-X* bus interfaces (secondary bus) • PCI 2.3-compliant • PCI-X 1.0b-compliant
P5	Intel® 82563	<p>Physical Layer Transceiver (PHY) component designed for 10/100/1000 Mbps operation:</p> <ul style="list-style-type: none"> • IEEE 802.3 (10BASE-T), IEEE 802.3u (100BASE-TX), IEEE 802.3ab (1000BASE-T) • Dual port
P6	Intel® 82551QM	<p>Fast Ethernet PCI bus controller:</p> <ul style="list-style-type: none"> • IEEE 802.3 (10BASE-T), IEEE 802.3u (100BASE-TX), 32-bit PCI bus master interface
P7	ATI* ES1000	<p>Graphics processing unit:</p> <ul style="list-style-type: none"> • 2D graphics accelerator • PCI bus interface (PCI 2.2 compliant, 33 MHz)
P8	VRAM	<p>64 MB VRAM for ATI ES1000:</p> <ul style="list-style-type: none"> • Max resolution: Up to 1280 x 1024, 85 Hz • Max color depth: Up to 32 bpp true color

Table 7. Main Board Components

Board Location	Component	Description
P9	LSI Logic* SAS1068	<p>PCI-X* to 3 Gb/s 8-port SAS controller. Four of the eight ports are used.</p> <ul style="list-style-type: none"> • 1.5 and 3 Gb/s SAS and SATA data transfer rates per port, full duplex • 64-bit, 133 MHz PCI-X host interface • Integrated RAID support <ul style="list-style-type: none"> – Fusion-MPT* architecture – Integrated Striping* technology (RAID0) – Integrated Mirroring* technology (RAID1)
P10	H8S/2166	Baseboard management controller (BMC)
P11	SIO	Super I/O
P12	FPGA	Management interface and shared memory extension bridge
P13	Battery	CMOS backup
P14	ID SW	This is a button combined with an LED. It can be used to identify a particular system and is useful in locating a particular system among many. The first time the button is pressed, the LED turns on. If the button is pressed again, the LED will blink and then turn off.
P15-P20	PCI-X* / PCI-Express* slot	
Attention Switch	Switch used for hot swapping PCI cards.	
P21	7SEG LED	Indicates POST code
P22-P27	PCI-X/e slot	
Power LED	LED to indicate an active PCI slot status	
P28-P33	PCI-X / PCI-Express* slot	
Attention LED	LED to indicate an error other PCI card slot condition. See “PCI Card Slot” on page 15.	

Table 8. Main Board External I/O Connectors

Board Location	Connector	Description
E1	Serial	RS232C D-sub 9-pin serial port
E2	VGA	Mini D-sub 15-pin video port
E3	USB 0/1/2/3	USB Type A port x4
E4	GbE LAN 0/1	RJ45 LAN port x2
E5	100 MbE LAN	RJ45 LAN port x1
E6	100 MbE LAN	RJ45 LAN port x1 (for KVM)

Table 9. Main Board Internal I/O Connectors

Board Location	Connector	Description
C1~C4	CPU 0/1/2/3	mPGA700 ZIF sockets
C5/C8	PCI slot 1/4	x8 PCI-Express* slots
C6/C9	PCI slot 2/5	x16 PCI-Express slots
C7/C10	PCI slot 3/6	64-bit 133 MHz PCI-X* slots
C11~C14	VHDM 0/1/2/3	
C15~C20	FAN 0/1/2/3/4/5	
C21/C22	PS 0/1	
C23	SAS	SFF-8484 (SAS internal x4 connector)
C24	ATA	40-pin IDE connector
C25	PNL	
C26	PNLPW	
C27/C28	MVR0/1, MVR2/3	
C29	XDP	
C30	KVM	
C31	SATA	
C32	IPMB	
C33	DEBUG	

Configuration Restrictions

Table 10. Configuration Restrictions

AC Input			Configuration			
Input Voltage	Number of Mounted AC/DC	AC/DC Redundancy	Maximum Number of Processors		PCI-Express* Graphics Card (75 W)	Configuration Restriction
			Intel® Itanium® 2, 533 MTS	Intel® Itanium® 2, 667 MTS		
100-127	2	No	4	0	2	No
			0	4	2	No
200-240	2	Yes	4	0	2	No
			0	4	Restricted, see note below	Yes
	1	No	4	0	2	No
			0	4	Restricted, see note below	Yes

Note: When one or two 75-watt PCI-Express* graphics cards are installed, the system will supply power for that slot during the power-on sequence or hot-add process. Then, on finding the violation of the configuration restriction, the system halts the power supply to the slot. In the case of a hot-add, since the operating system cannot identify the hot-added card as 75 watt, the 75-watt card cannot be hot added in restricted cases.

Processor Configurations

Figure 14 shows the top view of main board, indicating the processor locations. Table 11 shows the allowed processor configurations. Choose your configuration from Table 11 and install each processor in the locations indicated by Figure 14.

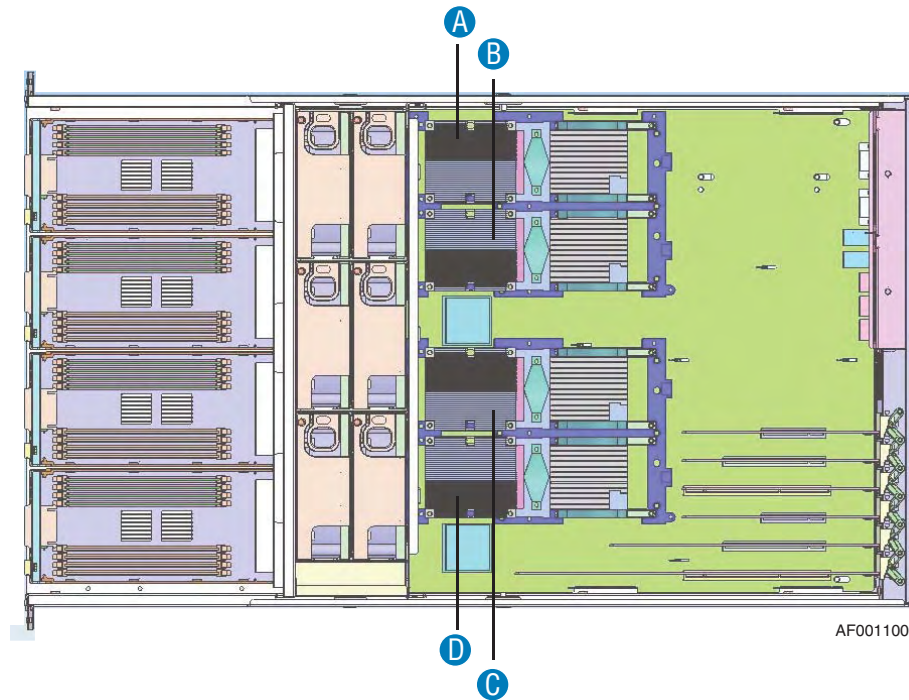

A. Processor 1	C. Processor 3
B. Processor 2	D. Processor 4

Figure 14. Processor Locations

Table 11. Supported Processor Configuration

Configuration Number	Processor Socket 0	Processor Socket 1	Processor Socket 2	Processor Socket 3
1	Installed	Not Installed	Not Installed	Not Installed
2	Installed	Installed	Not Installed	Not Installed
3	Installed	Not Installed	Installed	Not Installed
4	Installed	Installed	Installed	Not Installed
5	Installed	Installed	Installed	Installed

Memory Box Card

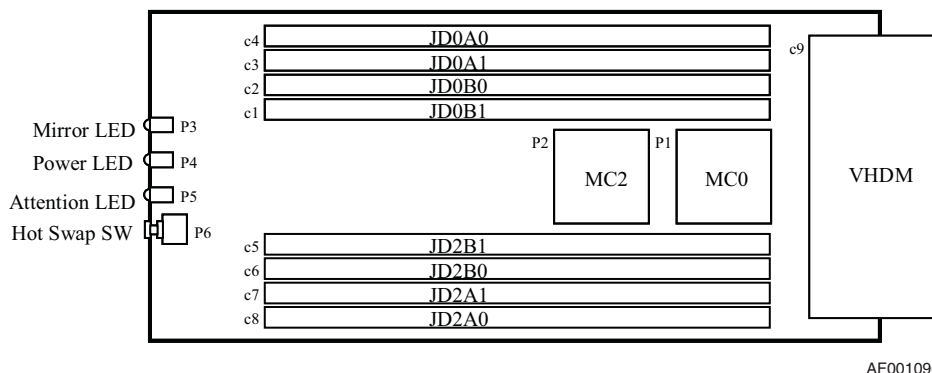

Figure 15. Memory Box Card Layout

Table 12. Memory Box Card Components

Board Location	Component	Description
P1/P2	MC0/2	Memory Controller
P3	Mirror LED	See “Memory Box” on page 8.
P4	Attention LED	See “Memory Box” on page 8.
P5	Power LED	See “Memory Box” on page 8.
P6	Hot Swap Button	

Table 13. Memory Box Card Connectors

Board Location	Connector	Description
C1	JD0B1	240-pin DDR2 DIMM socket (MC0 channel A)
C2	JD0B0	240-pin DDR2 DIMM socket (MC0 channel A)
C3	JD0A1	240-pin DDR2 DIMM socket (MC0 channel B)
C4	JD0A0	240-pin DDR2 DIMM socket (MC0 channel B)
C5	JD2B1	240-pin DDR2 DIMM socket (MC1 channel A)
C6	JD2B0	240-pin DDR2 DIMM socket (MC1 channel A)
C7	JD2A1	240-pin DDR2 DIMM socket (MC1 channel B)

Table 13. Memory Box Card Connectors

Board Location	Connector	Description
C8	JD2A0	240-pin DDR2 DIMM socket (MC1 channel B)
C9	VHDM	

DIMM Configurations

Figure 16 shows the DIMM locations within each memory box. One memory box houses either four or eight DIMMs. For a four-DIMM configuration, the DIMMs should be installed into locations JD0A1, JD0B1, JD2B1 and JD2A1.

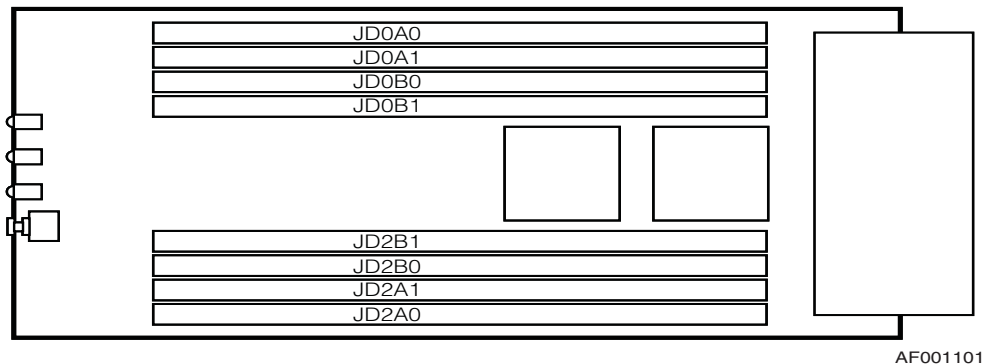

Figure 16. DIMM Locations (Top View of Memory Box)

Three memory modes are available. The memory mode is selected depending on the number of memory boxes that are connected to one NDC chip, and whether the BIOS is configured for mirror mode. See the following table for information.

Table 14. Memory Operational Modes

Memory Operational Mode	Description	Number of MMR Connected to One NDC	BIOS Set-Up of Mirror Mode	Redundancy and Hot-swap Support
Single	One MMR is connected to an NDC. No redundancy. Throughput of data transfer is half that of Double mode.	1	Disabled or Enabled	No
Double	Two MMRs are connected to an NDC. No redundancy. Throughput of data transfer is double that of Single mode.	2	Disabled	No
Mirror	Two MMRs are connected to an NDC and the same data is stored in these two MMR. Two MMRs are running like a mirror of each other and provide redundancy. Throughput of data transfer is half that of Double mode.	2	Enabled	Yes

The following figures show the installation order and upgrade path for DIMMs, and the applicable mode for each configuration. In these figures, solid lines indicate installed memory boxes; dotted lines indicated locations of empty memory box sockets. Black boxes indicate installed DIMMs.

The first set of figures (1-A, 2-A, 3-A, 4-A) represent configurations in which four DIMMs are installed in each installed memory box. The paths to the right of the figures marked 'W', 'X', 'Y', and 'Z' show the upgrade to fully populated memory boxes (eight DIMMs in each memory box). These fully populated configurations are shown in the second set of figures (1-B, 2-B, 3-B, 4-B).

For example, configuration 1-A has only one MMR with four DIMMs installed, so only single mode is applicable. This configuration can be connected to three paths for upgrade, that is, to 2-A, 3-A, and 1-B.

In the paths to 2-A and 3-A, another memory box is needed. 2-A has a higher memory bandwidth than 3-A, because 2-A can use two NDC chips effectively. In 3-A, processors connected to the NDC linked to the MC with DIMMs installed can access all of the system memory with the shortest access time. Therefore, in some specialized situations, 3-A has a performance advantage to 2-A, such as in a two-socket installation.

In the path to 1-B no new memory box is needed and therefore has a lower cost for capacity addition.

Memory mirroring is applicable to 3-A, but not to 2-A nor 1-B.

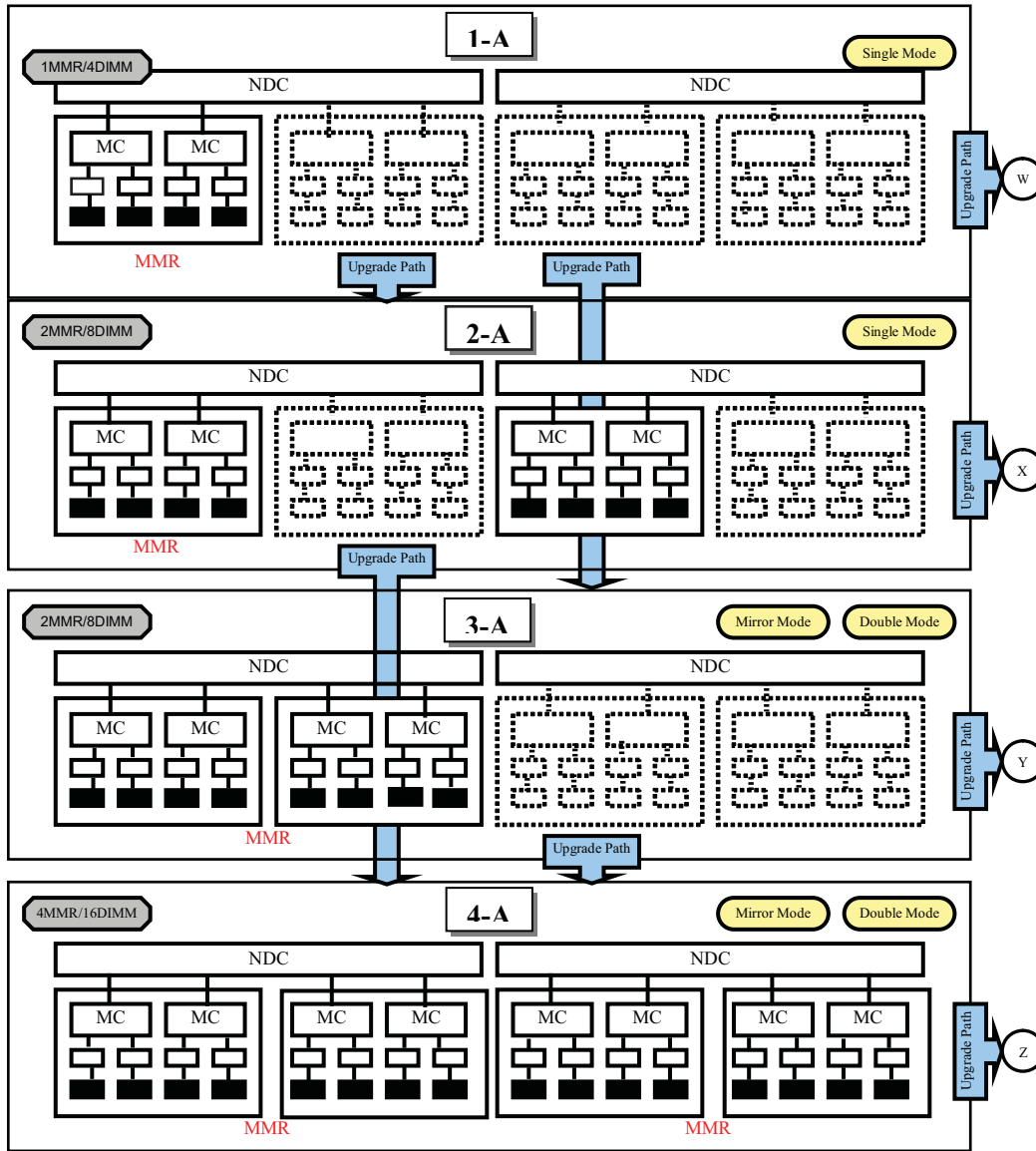

AF001102

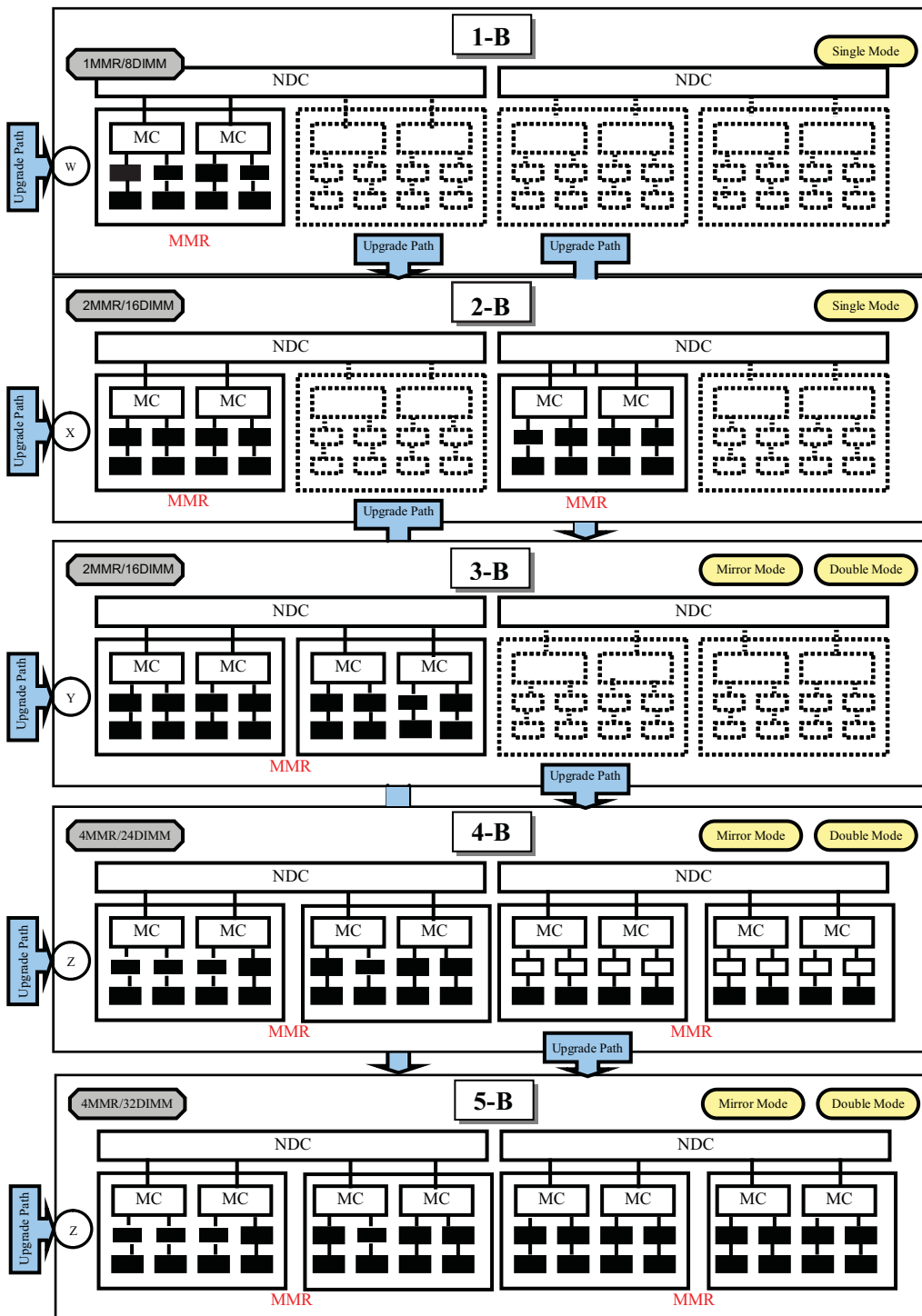

AF001103

Figure 17. Memory Upgrade Path

Hard Drive Backplane

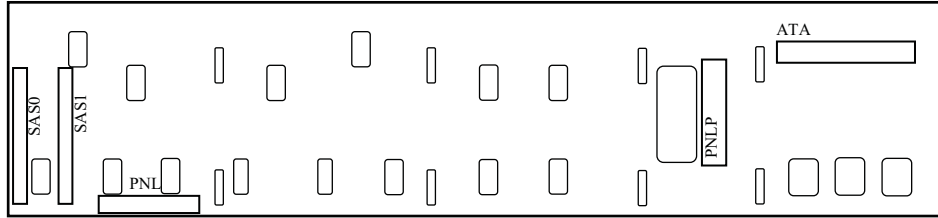

AF001097

Figure 18. Hard Drive Backplane Top View

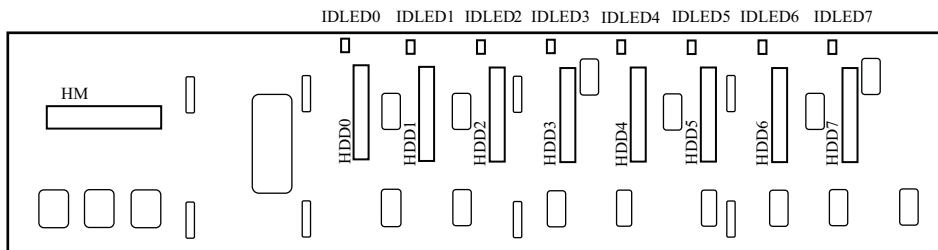

AF001098

Figure 19. Hard Drive Backplane Bottom View

Table 15. Hard Drive Backplane Connectors

Board Location	Connector	Description
C0	HDD0/1/2/3	SFF-8482 (SAS internal x1 connector)
C1	HDD4/5/6/7. See note below	SFF-8482 (SAS internal x1 connector)
C2	SAS0	SFF-8484 (SAS internal x4 connector)
C3	SAS1. See note below	SFF-8484 (SAS internal x4 connector)
C4	ATA	40-pin IDE connector
C5	PNL	Panel connector
C6	PNLPW	Panel power

Note: Available when additional SAS PCI card is inserted into PCI slot.

Hard Drive Population

The on-board SAS controller is connected to four of the eight hard drives, drives 0 through 3. Hard drives 4 through 7 require the addition of an add-in SAS card.

Front Panel Board

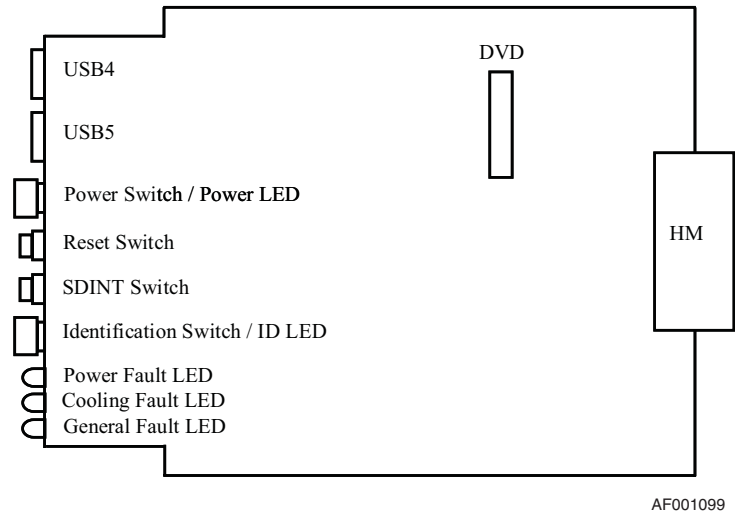

Figure 20. Front Panel Board Layout

Table 16. Front Panel Board Components

Board Location	Component	Description
P1	Power Button, Power LED	See “Front Panel” on page 5.
P2	Reset Button	See “Front Panel” on page 5.
P3	SDINT (System Diagnostic Interrupt) Button	See “Front Panel” on page 5.
P4	Identification Switch, Identification LED	See “Front Panel” on page 5.
P5	Power Fault LED	See “Front Panel” on page 5.
P6	Cooling Fault LED	See “Front Panel” on page 5.
P7	General Fault LED	See “Front Panel” on page 5.

Table 17. Front Panel Board Connectors

Board Location	Connector	Description
C1	HM	
C2	DVD	
C3	USB4/5	USB Type A port x2

3 Installing and Removing Components

To complete many of the installation or removal procedures in this chapter, you will need to first install or remove other components. For example, to remove the PCI card divider, you first need to remove the chassis cover, the power supplies, the power supply box, the CPU1/CPU2 MVR cable, the KVM card, and all add-in cards. This guide will direct you to each installation / removal section as is necessary to accomplish your final goal. This means you may need to change pages several times to move from one procedure to the next.

Cautions:

- *Installing and replacing optional components inside the server is to be performed only by trained personnel.*
- *Before following any of the procedures in this chapter, review all of the safety instructions located in “[Safety Information](#)” on page 193.*
- *Unless you are performing a hot swap function for hot swap instructions are provided, you must turn off your system and disconnect all power plugs before beginning any procedure in this chapter.*
- *Do not subject the hard drive to vibrations or impacts. Drive failure may result from vibrations or impacts.*
- *Before hot-swapping, be sure to completely understand the procedures written in this manual.*

Tools Needed

The following tools are needed to install or remove the hardware described in this chapter.

- Phillips* screwdriver #2
- Flathead screwdriver 5.5 x 75
- 2.5 mm hex driver
- Torx-15* driver
- Cotton gloves
- Antistatic wrist strap

Installing and Removing the Front Bezel

You will need to remove the front bezel to perform the following operations:

- To install or remove a memory box
- To install or remove DIMMs
- To install or remove an optical drive
- To install or remove the front control panel
- To install or remove the hard drive backplane
- To install or remove the mounting plate

Removing the Front Bezel

1. Insert your finger(s) into the hole at the left side of the front bezel. See letter “A” in the figure below.
2. Pull the bezel firmly.

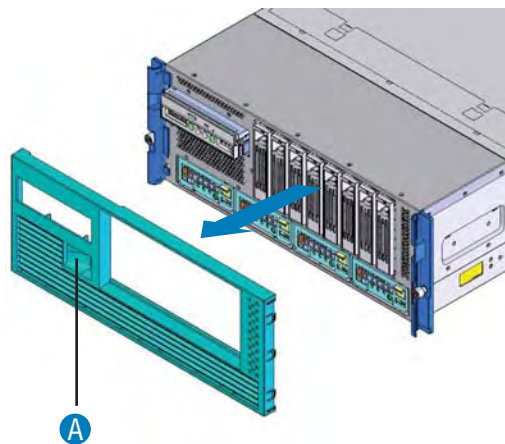
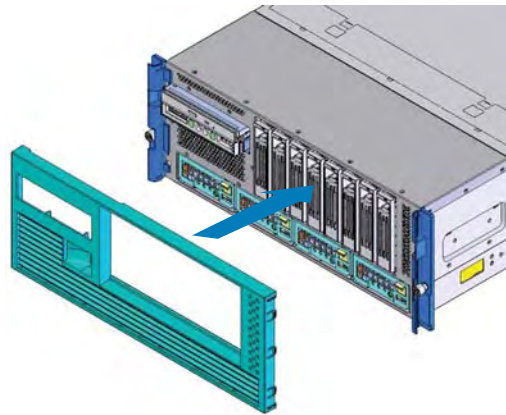

Figure 21. Removing the Front Bezel

Installing the Front Bezel

1. Set the left or right side of the bezel into place at the front of the system.
2. Set the opposite side of the bezel into place.
3. Push firmly until the bezel snaps into place.



AF001105

Figure 22. Installing the Front Bezel

Installing and Removing the Top Cover

You will need to remove the top cover to perform the following operations:

- To install or remove a power supply
- To install or remove the power supply box
- To install or remove the power supply support
- To install or remove a fan
- To install or remove the fan box
- To install or remove a PCI card
- To install or remove the PCI card divider
- To install or remove the KVM card
- To install or remove the air flow guide
- To install or remove the hard drive backplane cover
- To install or remove the hard drive backplane
- To install or remove a processor
- To install or remove the mounting plate

Removing the Top Cover

1. Pull up on the two levers on the top cover. See letter “A” in the following figure.
2. Lift the cover from the system. See letter “B” in the figure.

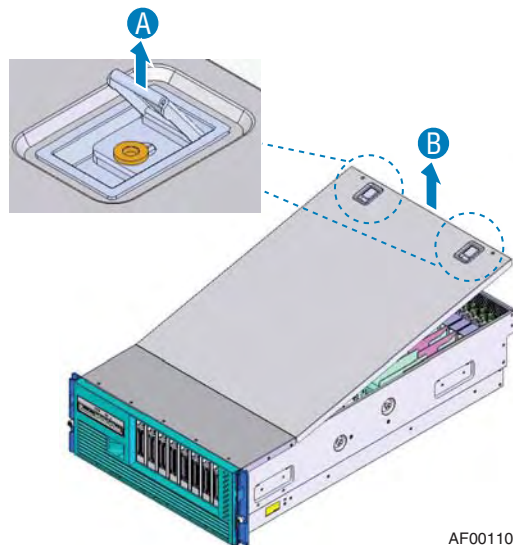

AF001106

Figure 23. Removing the Top Cover

Installing the Top Cover

1. Place the front edge of the cover on the chassis.
2. Lower the rear of the cover into place, as shown by letter “A” in the figure below.

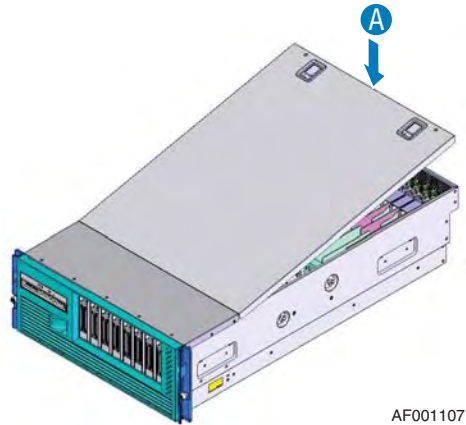

Figure 24. Installing the Top Cover

Installing and Removing a Hard Drive

You will need to remove the hard drive(s) or the hard drive carriers to perform the following operations:

- To replace a hard drive
- To install or remove the hard drive backplane
- To install or remove the mounting plate

Cautions:

- *Handle the hard drive carefully. Inappropriate handling may result in hard drive failure.*
- *Always create backup copies of important data on the hard disk. If the hard drive fails, all data stored on it will be lost.*

Installing a Hard Drive

Caution: Before performing the procedures written in this chapter, except for when hot-swapping, be sure to turn off the system and disconnect all power plugs.

1. Push down on the button at the top of the drive carrier lever. See letter “A” in the figure below.
2. While holding down the button, pull forward on the lever to open it. See letter “B”.
3. Continue pulling on the lever to slide the carrier from the system.

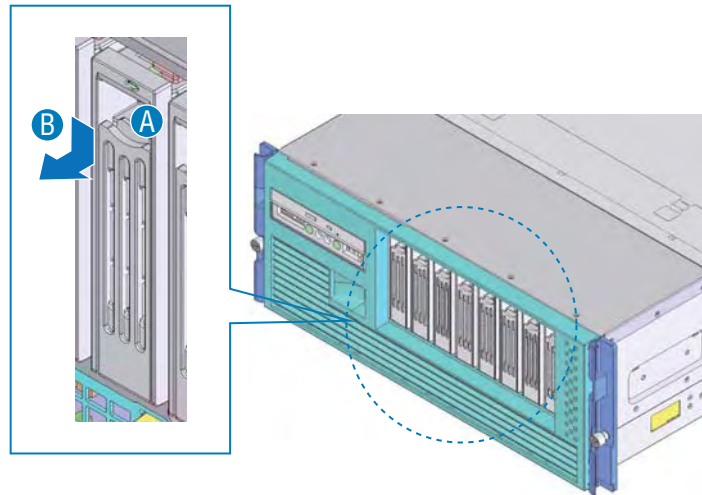

AF001108

Figure 25. Pulling Down on the Hard Drive Carrier Lever

4. Remove the four screws at the sides of the hard drive carrier. Two screws are at each side of the carrier. See letter “A” in the figure below.

Note: Do not remove the metal EMI shield from the carrier.

5. Set the hard drive into the hard drive carrier, with the connections extending from the rear of the carrier.
6. Install the four screws that you removed in step 4, two on each side of the carrier. See letter “A” in the figure below.

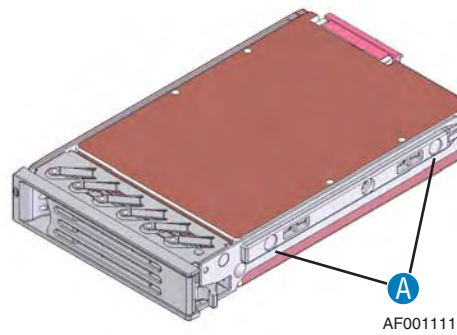

Figure 26. Mounting a Hard Drive

7. Open the hard drive carrier lever if it is closed.
8. Slide the hard drive carrier into the bay along the guide rail. See the figure below.
9. When the lower part of the lever touches the bay, push the lever closed while pushing the carrier into the system.

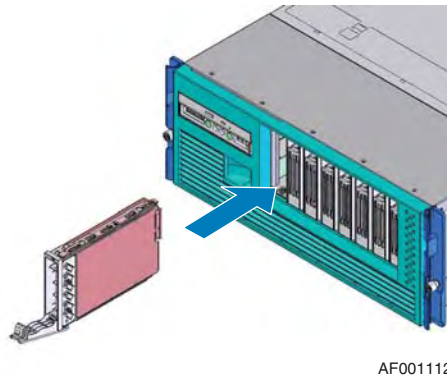

Figure 27. Installing a Hard Drive

Removing a Hard Drive

Cautions:

- *Before performing the procedures in this chapter, except for when hot-swapping, turn off the system and disconnect all power plugs.*
- *If you attempt to replace a faulty hard drive using inappropriate procedures may result in data corruption.*
- *Before replacing any hard drives, back up all data.*
- *Replacing a hard drive that has not failed may corrupt data on the drive. Remove only the failed drive.*
- *Do not subject the hard drive to vibrations or impacts. Drive failure may result from vibrations or impact.*

1. Push down on the button at the top of the drive carrier lever. See letter “A” in the figure below.
2. Pull forward on the lever to open it. See letter “B”.
3. Continue pulling on the lever to slide the carrier from the system.

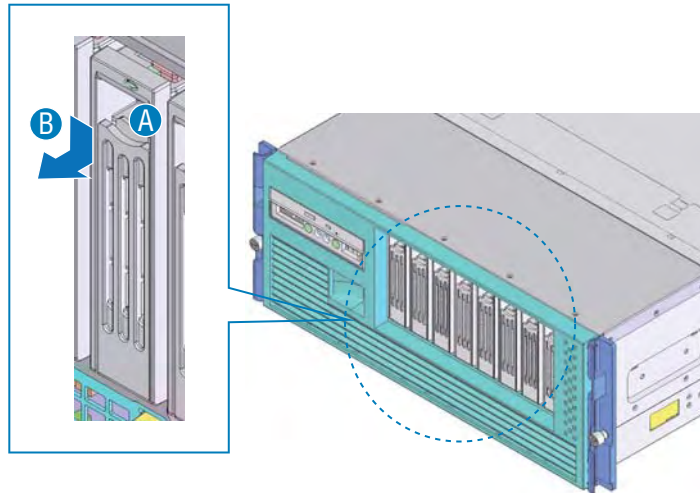

AF001108

Figure 28. Pulling Down on the Hard Drive Carrier Lever

4. Remove the four screws at the sides of the hard drive carrier. Two screws are at each side of the carrier. See letter “A” in the figure below.

Note: Do not remove the metal EMI shield from the carrier.

5. Lift the drive from the carrier.

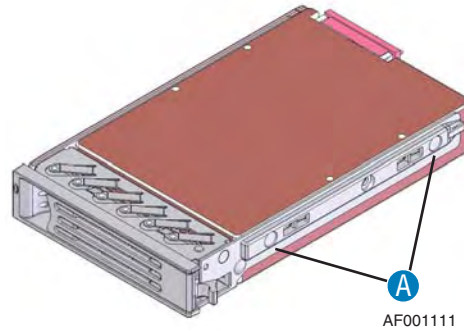

Figure 29. Unmounting a Hard Drive

6. Determine your next course of action and refer to the appropriate steps:
 - If you are installing a replacement hard drive, see [“Installing a Hard Drive” on page 38](#), beginning with step 5.
 - If you are following these steps as part of another procedure, return to that procedure.
 - If you have completed working with the drive carrier, slide it back into the chassis opening.

Hot-swapping a Hard Drive

Note: Remove only the failed drive. Removing the wrong drive could cause the system to malfunction or may cause data loss.

1. Use the LED indicators at the top of the hard drive carriers to determine which drive has failed. The red LED indicates the failed hard drive. See letter “A” in the figure below.

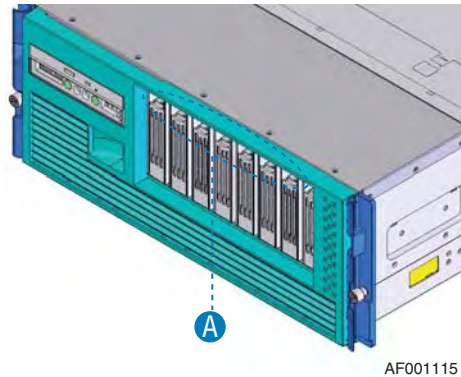

Figure 30. Hard Drive LED Indicators

2. Install the new hard drive. See “Installing a Hard Drive” on page 38.

Installing and Removing a Memory Box

Your system was shipped with two memory boxes installed and two memory box filler panels installed. Before you can use your server system, each memory box must be populated with either four or eight DIMMs.

Note: The system will not boot if a memory box is installed with no DIMMs in it.

You will need to remove the memory box to perform the following operations:

- To replace a memory box
- To install or remove DIMMs
- To install or remove the mounting plate

Installing a Memory Box

To perform this procedure, you will first need to remove the front bezel. The steps below will direct you to the instructions on removing the front bezel at the appropriate location in the step sequence.

Caution: Before performing the procedures in this chapter, except for when hot-swapping, turn off the system and disconnect all power plugs.

1. Remove the front bezel. For instructions, see [“Removing the Front Bezel” on page 34](#).
2. If a filler panel is installed, pull up on the memory box filler panel release lever to unlock it. See letter “A” in the figure below.

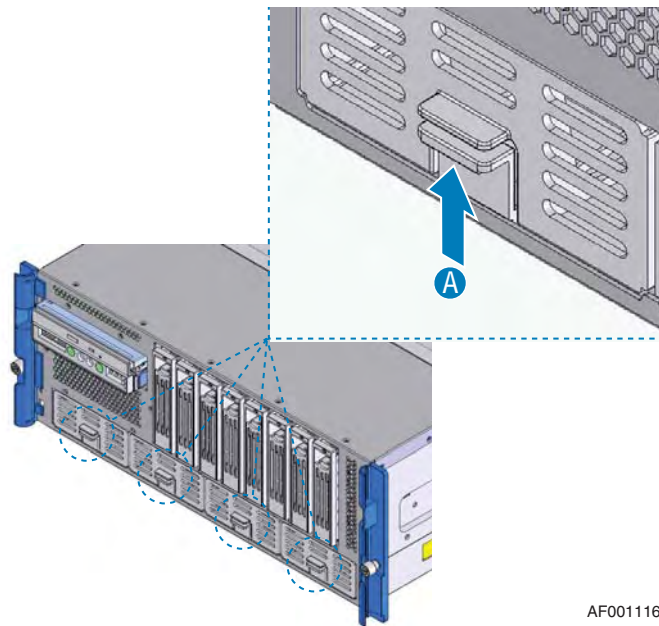

AF001116

Figure 31. Removing the Memory Box Filler Panel

3. While holding the release lever up, pull the memory box filler panel from the system. Save the filler panel for future use.
4. If necessary, install DIMMs into the memory box. For instructions, see [“Installing DIMMs” on page 49](#).
5. Pull out on the metal front edge of the memory box.

- Carefully slide the memory box into the bay. When the memory box is correctly inserted the notches at the sides of the metal cover align with the edge of the bay. See the figure below.

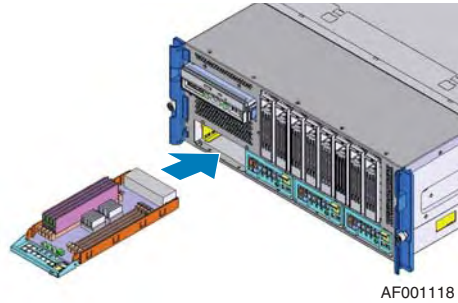

Figure 32. Installing the Memory Box

- Close the metal cover. See letter “A” in the following figure. If the metal cover does not close easily, the memory box is not positioned correctly in the bay. Slide the memory box out slightly and try again to close the cover.
- Lift the memory box eject lever into the locked position. Make sure the lever is fully closed. See letter “B” in the following figure.

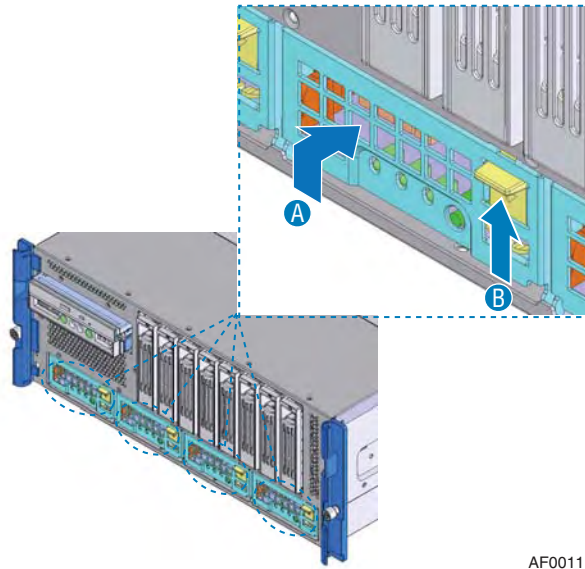

Figure 33. Memory Box Installed and Locked into Place

- Determine your next course of action and refer to the appropriate steps:
 - If you are following these steps to complete another procedure, return to those steps.
 - If you have finished with all steps and procedures, install the front bezel. For instructions, see [“Installing the Front Bezel” on page 35](#).

Removing a Memory Box

To perform this procedure, you will first need to remove the front bezel. The steps below will direct you to the instructions on removing the front bezel at the appropriate location in the step sequence.

Caution: Before performing the procedures in this chapter, except for when hot-swapping, turn off the system and disconnect all power plugs.

1. Remove the front bezel. For instructions, see [“Removing the Front Bezel” on page 34](#).
2. Push down on the memory box release lever to unlock the memory box. See letter “A” in the figure below.
3. Fully open the metal cover on the memory box. See letter “B” in the figure.
4. Carefully pull the memory box from the system and place it on a clean, static-free surface.

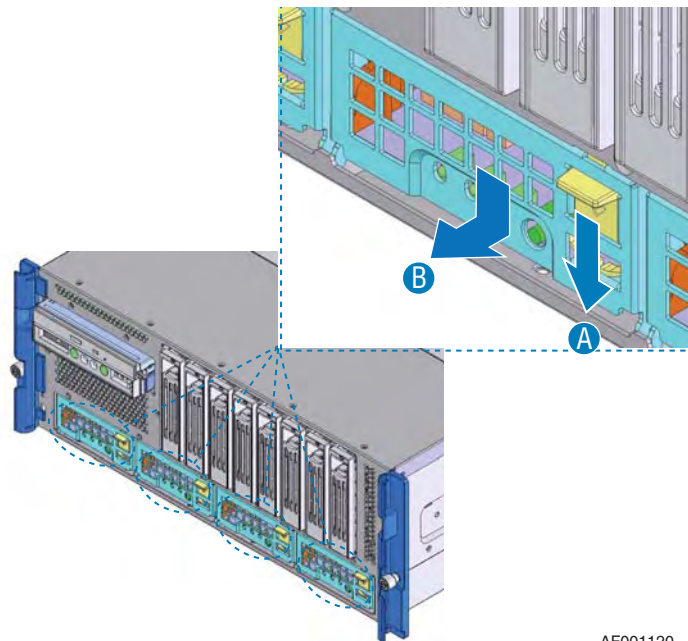

AF001120

Figure 34. Removing the Memory Box

5. Determine your next course of action and refer to the appropriate steps:
 - If you are following these steps as part of another procedure, return to that procedure.
 - If a memory box will not be re-installed, slide a memory box filler panel into the open memory box slot until it clicks into place.
6. Install the front bezel. For instructions, see [“Installing the Front Bezel” on page 35](#).

Hot-swapping a Memory Box

To perform this procedure, you will first need to remove the front bezel. The steps below will direct you to the instructions on removing the front bezel at the appropriate location in the step sequence.

Cautions:

- Before hot-swapping the memory box, confirm that hot-swapping can be performed by checking the following:
 - Memory Mirroring is set to “Enable” as shown in “Memory Screen” on page 148.
 - DIMMs are configured as either of the configuration patterns 3A, 4A, 3B, 4B, or 5B described as “Mirror Mode” in “DIMM Configurations” on page 25.
 - The green mirror LEDs are turned on. See Figure 35.
- Wear an antistatic wrist strap.
- Be sure to remove/replace only the intended memory box. If the memory box has failed, then the Attention LED for the failed memory box will be orange.
- Follow the hot-swap sequence described below. Failure to follow the steps may result in a system malfunction.

The following diagram shows the LEDs and components on the front of the memory box.

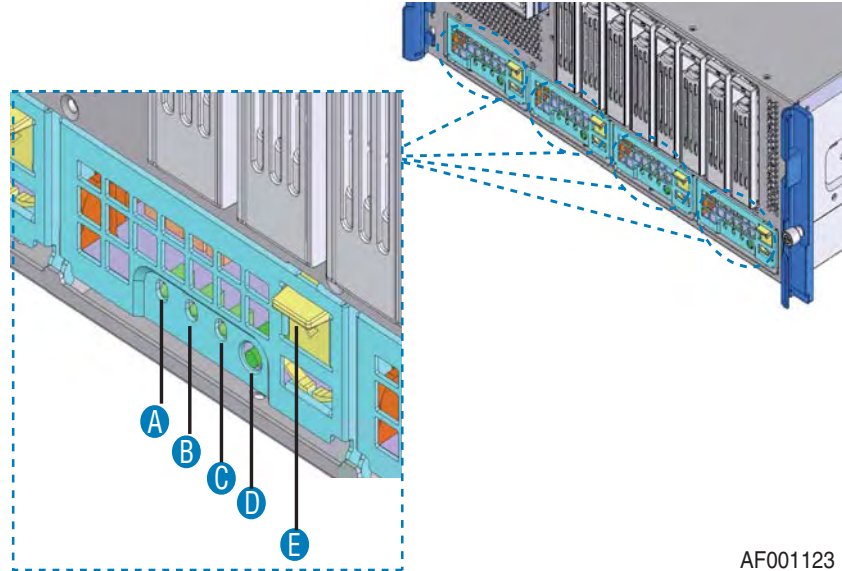

AF001123

A. Mirror LED (green)	D. Hot-swap button
B. Power LED (green)	E. Eject lever
C. Attention LED (orange)	

Figure 35. Memory Box Front View

1. Remove the front bezel. For instructions, see [“Removing the Front Bezel” on page 34](#).
2. Push the hot-swap button for the memory box you want to remove. To cancel the operation, push the button again within five seconds.
3. The power LED blinks; wait for all memory box LEDs to turn off. If the status LED does stop blinking, shut down the system to replace the memory box.
4. Remove the memory box. For instructions, see [“Removing a Memory Box” on page 45](#). Then return to these steps.

Warning: *The memory box will be very hot. Do not touch any components on it.*

5. Wait approximately 10 minutes to allow the memory box to cool before touching any components on it.
6. Install, remove, or replace the DIMMs as necessary. See [“Installing and Removing DIMMs” on page 48](#).
7. Install the memory box. For instructions, see [“Installing a Memory Box” on page 43](#), beginning with step 5. Then return to these steps.
8. Push the hot-swap button for the memory box. If the attention LED turns on after pushing the button, see if the DIMM configuration is the same or different as the configuration before you performed the hot-swap operation.
 - If the configuration is different, repeat steps 2 through step 6. Configure the DIMMs. Continue this series of steps with step 7 above.
 - If the configuration is the same, a fault exists in DIMM or in the memory box. Repeat these steps, using different DIMMs or a different memory box.

The power LED blinks, and then turns on solidly. The mirror LED blinks and then it turns on solidly. Memory mirroring functions resume after the mirror LED is on solidly.
9. If the power and memory LED do not return to solid on, power off the system to remove the memory box and repeat the installation.
10. Install the front bezel. For instructions, see [“Installing the Front Bezel” on page 35](#).

Installing and Removing DIMMs

DIMM Installation Guidelines

Each installed memory box must have either four or eight DIMMs installed, as shown below.

- Four DIMM installation: Install DIMMs in JD0B1, JD0A1, JD2B1, JD2A1
- Eight DIMM installation: DIMMs installed in each socket

Note: When facing the front or rear of the memory box, the four sockets at the left are positioned in the opposite direction from the four sockets at the right. Be sure to reverse the DIMMs accordingly. Make sure the notches at the center of the DIMMs line up correctly with the tabs in the center of the sockets.

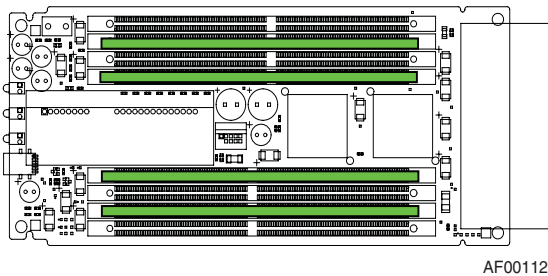

Figure 36. Four-DIMM Installation Pattern

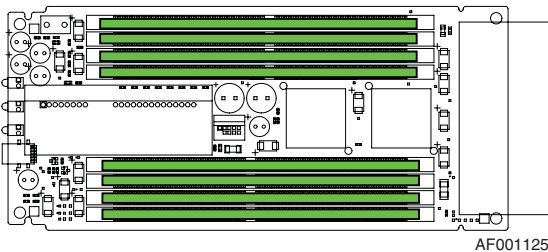

Figure 37. Eight-DIMM Installation Pattern

Note: The system will not boot if a memory box is installed with no DIMMs in it.

Installing DIMMs

To perform this procedure, you will first need to remove:

- The front bezel
- The memory box

The steps below will direct you to the instructions for these procedures at the appropriate location in the step sequence.

Cautions:

- *Before performing the procedures in this chapter, except for when hot-swapping, turn off the system and disconnect all power plugs.*
- *Be aware when removing the memory box that removed parts are hot. Wait approximately 10 minutes after removing the parts before handling them.*
- *Wear cotton gloves when handling DIMMs.*
- *Take precautions against static.*

1. Remove the memory box. For instructions, see [“Removing a Memory Box” on page 45](#).
2. Push out on the clips at each end of the DIMM socket(s) to open the DIMM sockets.
3. Insert the DIMMs so that the tab in the center of DIMM socket fits the notch of DIMM.

Note: *When facing the front or rear of the memory box, the four sockets at the left are positioned in the opposite direction from the four sockets at the right. Be sure to reverse the DIMMs accordingly. Make sure the notches at the center of the DIMMs line up correctly with the tabs in the center of the sockets.*

4. Push down firmly to seat the DIMM into the socket. The clips on each end of the socket will close.

Caution:

- ✧ *Do not apply force to peripheral parts when inserting a DIMM.*
- ✧ *DIMMs may be difficult to insert. Do not rock the DIMM back and forth when inserting it. Instead, apply steady, firm pressure.*

5. Make sure the DIMMs are inserted correctly and the clips are fully closed.
6. Install the memory box. For instructions, see [“Installing a Memory Box” on page 43](#), beginning with step 6.

Removing DIMMs

To perform this procedure, you will first need to remove:

- The front bezel
- The memory box

The steps below will direct you to the instructions for these procedures at the appropriate location in the step sequence.

Cautions:

- *Before performing the procedures in this chapter, except for when hot-swapping, turn off the system and disconnect all power plugs.*
- *Be aware when removing the memory box that removed parts are hot. Wait approximately 10 minutes after removing the parts before handling them.*
- *Wear cotton gloves when handling DIMM.*
- *Take measures against static.*

1. Remove the memory box. For instructions, see [“Removing a Memory Box” on page 45](#).
2. Push out on the clips at each end of the DIMM socket(s) to open them.

Note: *It may be difficult to open the clips on the memory socket. Do not apply force to peripheral parts when opening the clips.*

Caution: *Be careful not to touch peripheral parts when opening the clips for the DIMM socket.*

3. Pull the DIMM from the socket.

Caution: *Be careful not to apply force to peripheral parts when removing a DIMM.*

4. Install the memory box. For instructions, see [“Installing a Memory Box” on page 43](#), beginning with step 6.

Note: *The system will not boot if a memory box is installed with no DIMMs in it.*

Installing and Removing an Optical Drive

Installing an Optical Drive

To perform this procedure, you will first need to remove the front bezel. The steps below will direct you to the instructions on removing the front bezel at the appropriate location in the step sequence.

Note: Before performing the procedures in this section, turn off the system and disconnect all power plugs.

1. Remove the front bezel. For instructions, see [“Removing the Front Bezel”](#) on page 34.
2. Locate the optical drive location at the left side of the system. See the following figure.

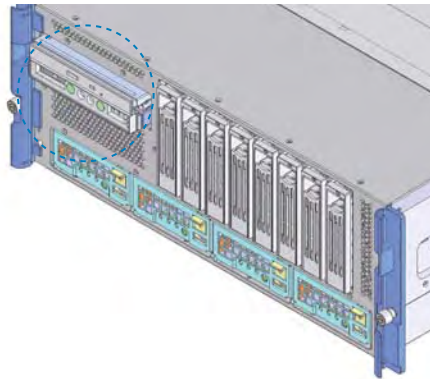
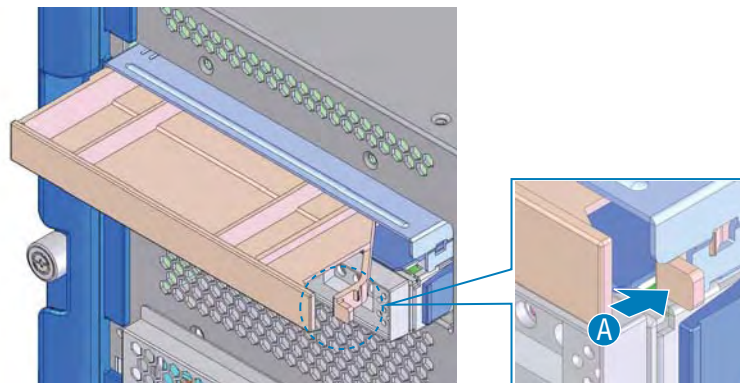

Figure 38. Locating the Optical Drive Installation Position

3. Push the lever on the side of the optical drive or the filler panel to remove it from the system. Keep the filler panel for future use.



AF001129

Figure 39. Removing the Optical Drive Filler Panel

4. With the rear of the optical drive facing you, as shown by letter “A” below, install the left side of the bracket onto the drive. The bracket (letter “B” in the figure) has a small tab that fits into a dimple in the drive sheetmetal.
5. Roll the right side of the bracket down until it clicks into place.

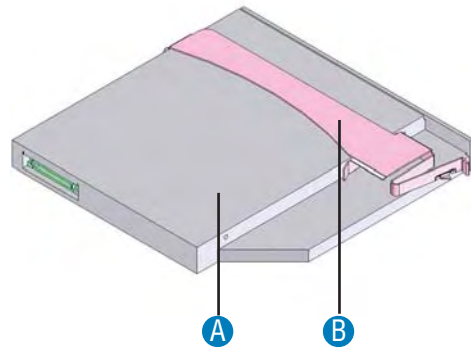

AF001117

Figure 40. Attaching the Optical Drive to the Bracket

6. Slide the optical drive assembly into the system until it clicks into place. See letter “A” in the figure below.

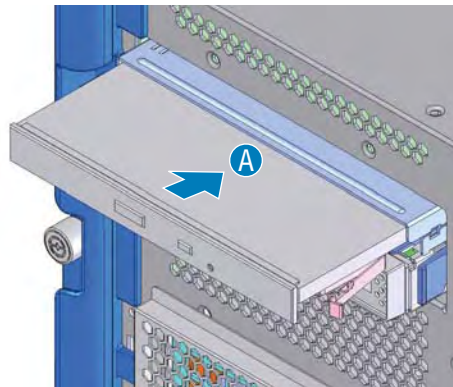

AF001130

Figure 41. Installing of Optical Drive

7. Install the front bezel. For instructions, see [“Installing the Front Bezel”](#) on page 35.

Removing the Optical Drive

To perform this procedure, you will first need to remove the front bezel. The steps below will direct you to the instructions on removing the front bezel at the appropriate location in the step sequence.

Note: Before performing the procedures in this section, turn off the system and disconnect all power plugs.

1. Remove the front bezel. For instructions, see [“Removing the Front Bezel”](#) on page 34.
2. Locate the optical drive location at the left side of the system. See the following figure.

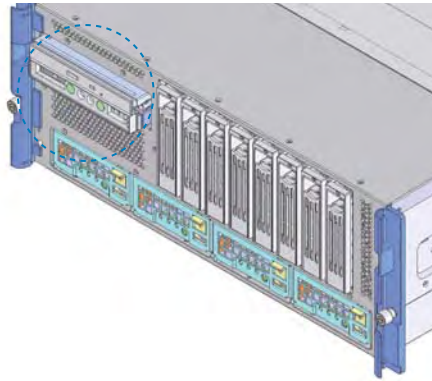
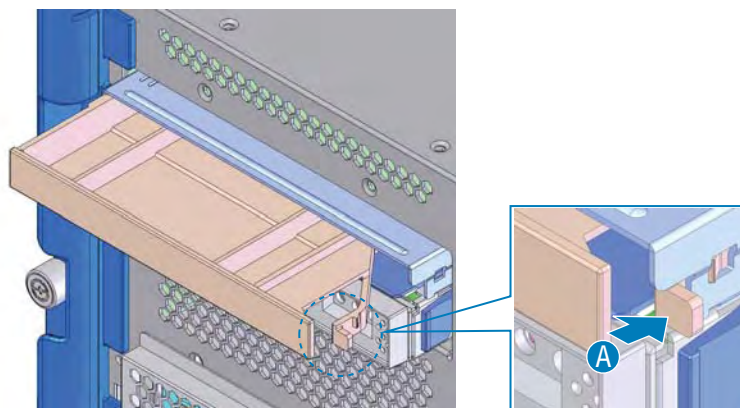

Figure 42. Locating the Optical Drive Installation Position

3. Push the lever on the optical drive to remove it from the system.



AF001129

Figure 43. Removing Optical Drive from Server

4. Push the lever to release the drive from the bracket. See letter “A” in the figure below.

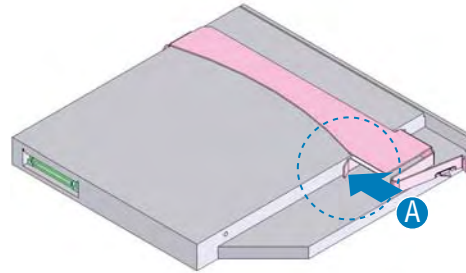

AF001132

Figure 44. Removing the Optical Drive from the Bracket

5. If you are not replacing the drive, insert the optical drive filler into the server until it clicks into place.

Caution: *Insert a blank/filler into any unused slot. Uncovered slots may reduce the cooling effect of the system.*

6. Install the front bezel. For instructions, see [“Installing the Front Bezel” on page 35](#).

Installing and Removing a Fan

You will need to remove the fan(s) to perform the following operations:

- To replace a fan
- To install or remove the fan box
- To install or remove the hard drive backplane
- To install or remove the mounting plate

Installing a Fan

To perform this procedure, you will first need to remove the top cover. The steps below will direct you to the instructions to remove the top cover at the appropriate location in the step sequence.

Before operating the procedures written in this chapter, except when hot-swapping, be sure to turn off the system and then disconnect all power plugs.

1. Remove the top cover. For instructions, see [“Removing the Top Cover” on page 36](#).
2. Locate the fan area of the system. See the following figure.

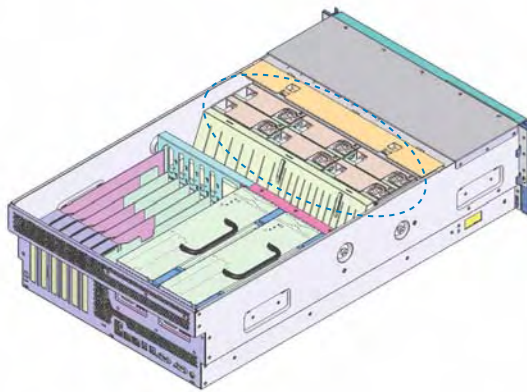

AF001133

Figure 45. Locating the Fans

3. Note the fan orientation in the figure below to make sure you insert the fan correctly. Insert the fan into the bay.

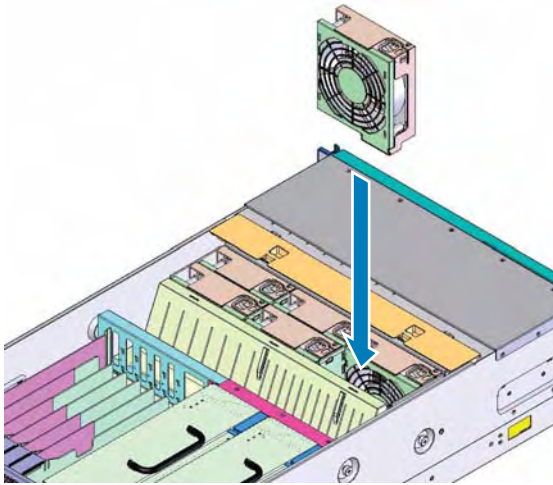

AF001134

Figure 46. Installing a Fan

4. Determine your next course of action and refer to the appropriate steps:
 - If you are following these steps as part of another procedure, return to that procedure.
 - Install the top cover. For instructions, see [“Installing the Top Cover”](#) on page 37.

Removing a Fan

To perform this procedure, you will first need to remove the top cover. The steps below will direct you to the instructions to remove the top cover at the appropriate location in the step sequence.

Caution: Before performing the procedures in this chapter, except for when hot-swapping, turn off the system and disconnect all power plugs.

1. Remove the top cover. For instructions, see “[Removing the Top Cover](#)” on page 36.
2. Locate the fan area in the system. See the following figure.

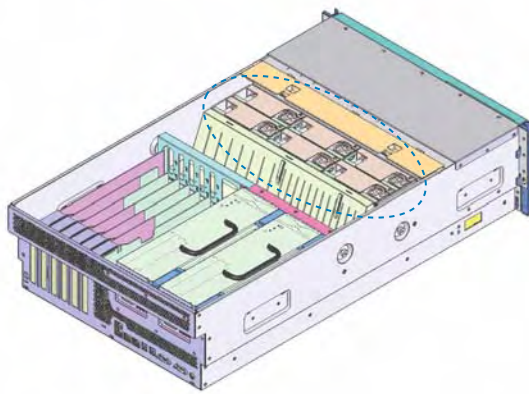

AF001133

Figure 47. Locating the Fans

3. Insert your thumb and a finger into the rounded and square holes at the top of the fan.
4. Lift the fan from the system.

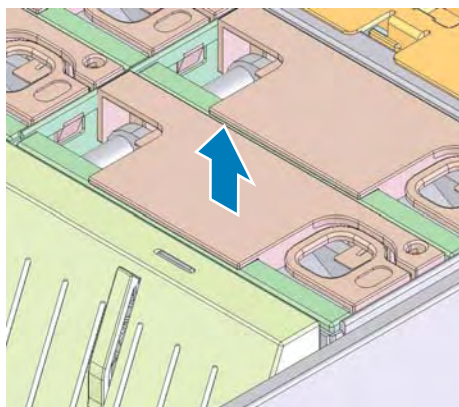

AF001135

Figure 48. Removing a Fan

5. Determine your next course of action and refer to the appropriate steps:
 - If you have removed a fan to replace a failed fan, see [“Installing a Fan” on page 55](#).
 - If you are following these steps as part of another procedure, return to that procedure.

Hot-swapping a Fan

To perform this procedure, you will first need to remove the top cover. The steps below will direct you to the instructions to remove the top cover at the appropriate location in the step sequence.

Cautions:

- *Replace the fan within two minutes of removing the failed fan. If a fan bay remains unpopulated for more than two minutes, the cooling system could fail.*
- *Remove only the failed component. Removing the incorrect component could cause the system to malfunction.*

1. Remove the top cover. For instructions, see [“Removing the Top Cover” on page 36](#).
2. Confirm that the cooling fan LED is turned off. This indicates the fan has a fault. See letter “A” in the following figure.

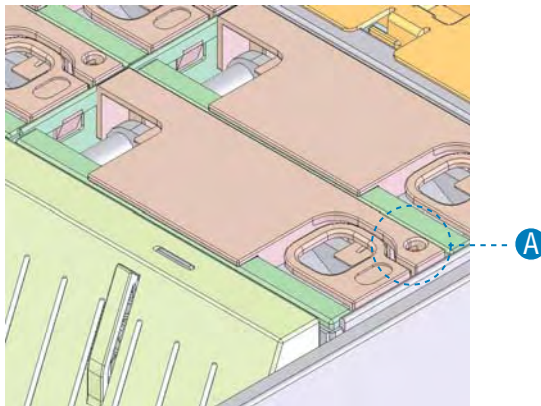

AF001137

Figure 49. Fan Fault LED

3. Remove the fan. See [“Removing a Fan” on page 57](#).
4. Install the new fan. See [“Installing a Fan” on page 55](#).
5. Install the top cover. For instructions, see [“Installing the Top Cover” on page 37](#).

Installing and Removing a PCI Card

You will need to remove the PCI card(s) to perform the following operations:

- To replace a PCI card
- To install or remove the PCI card divider
- To install or remove the fan box
- To install or remove the air flow guide
- To install or remove the hard drive backplane
- To install or remove the mounting plate
- To install or remove a processor

Installing a PCI Card

To perform this procedure, you will first need to remove the top cover. The steps below will direct you to the instructions to remove the top cover at the appropriate location in the step sequence.

Cautions:

- *Before performing the procedures in this section, except for when hot-swapping turn off the system and then disconnect all power plugs.*
- *Use caution when touching the add-in card to avoid touching components on the card.*

1. Remove the top cover. For instructions, see “[Removing the Top Cover](#)” on page 36.
2. Locate the PCI slot area. See the following figure.
3. Lift the PCI caution plate. See letter “A” in the figure below.

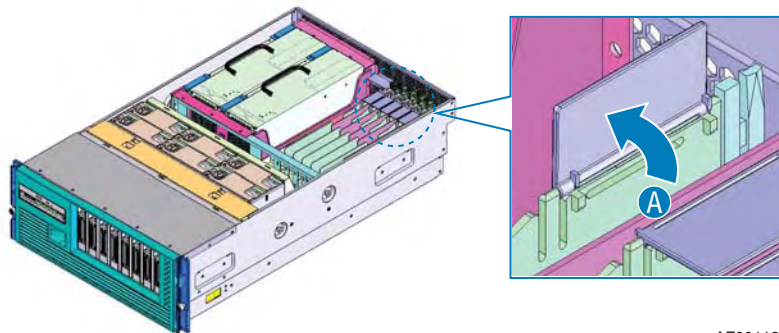

AF001138

Figure 50. Opening the PCI Caution Plate

4. Push the PCI card lock firmly to unlock the card or the slot cover. See the figure below.

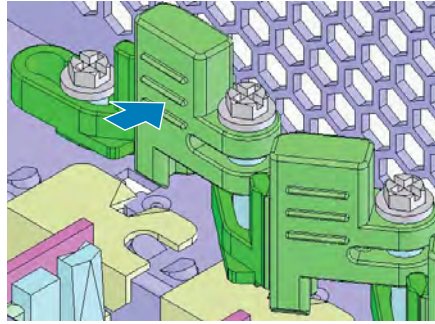

AF001139

Figure 51. Unlocking a PCI Card Lock

5. Remove the PCI slot cover. See the figure below. Keep the slot cover for future use.

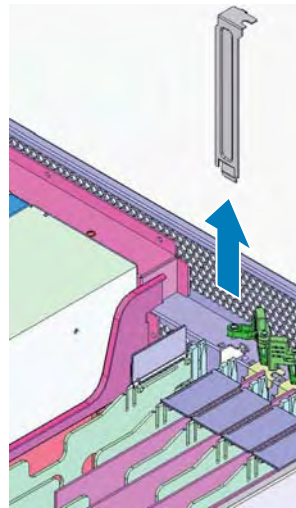

AF001140

Figure 52. Removing a PCI Slot Cover

6. Install the PCI card. See Figure 54.
 - For a short-length card, insert the PCI card firmly into the slot.
 - For a full-length card: Insert the PCI card into the slot. The end of the card at the front side of the chassis must be inserted and locked into place in the PCI tail lock. See Figure 53.

Note: Full-length cards can be installed only into PCI slot 6.

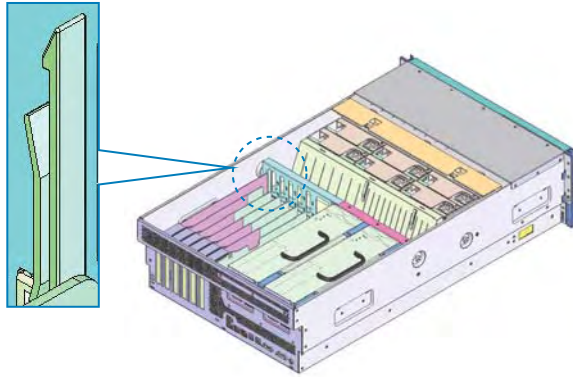

AF001136

Figure 53. PCI Tail Lock

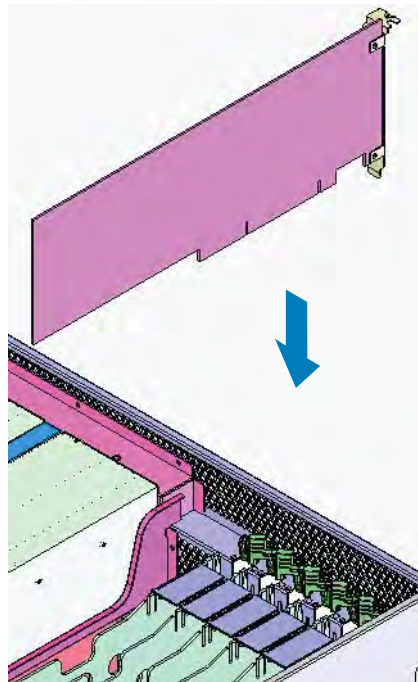

TP001141

Figure 54. Installing a PCI Card

7. Pull the PCI card lock firmly until it clicks into place. See the figure below.

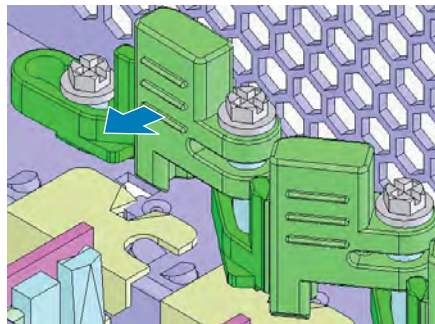

AF001142

Figure 55. Locking a PCI Card into Place

8. Lower the PCI caution plate. See letter “A” in the figure below.

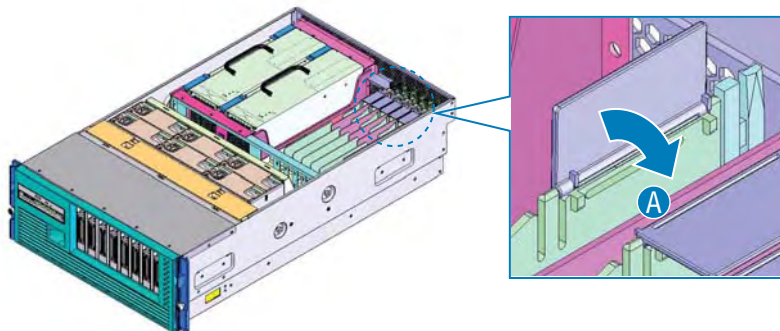

AF001144

Figure 56. Closing the PCI Caution Plate

9. Attach any cables necessary for the card you installed. See your add-in card documentation for information and instructions.
10. Determine your next course of action and refer to the appropriate steps:
 - If you are following these steps as part of another procedure, return to that procedure.
 - Install the top cover. For instructions, see [“Installing the Top Cover” on page 37](#).

Removing a PCI Card

To perform this procedure, you will first need to remove the top cover. The steps below will direct you to the instructions to remove the top cover at the appropriate location in the step sequence.

Cautions:

- *Before performing the procedures in this section, except for when hot-swapping turn off the system and then disconnect all power plugs.*
- *Use caution when installing the add-in card to avoid touching components on the card.*

1. Remove the top cover. For instructions, see [“Removing the Top Cover”](#) on page 36.
2. Raise the PCI caution plate. See letter “A” in the figure below.

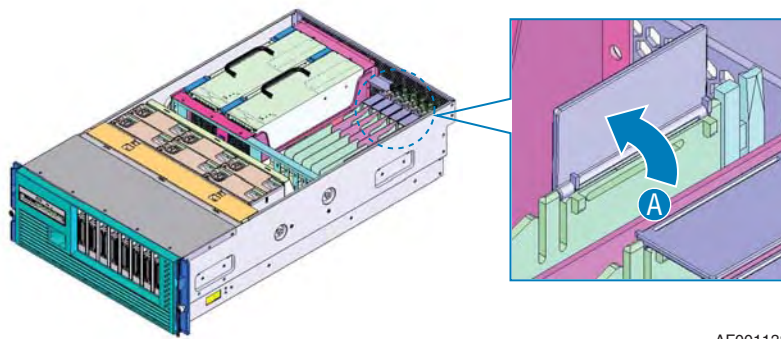

AF001138

Figure 57. Opening a PCI Caution Plate

3. Push the PCI card lock firmly to unlock the PCI card. See the figure below.

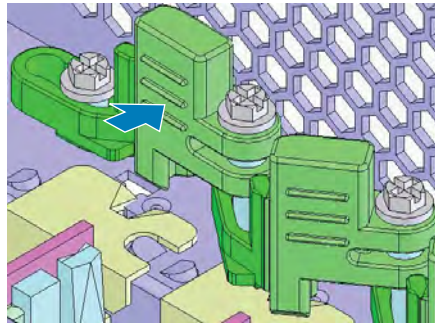

AF001139

Figure 58. Unlocking a PCI Card Lock

4. Remove the PCI card and place it on a clean, static-free surface.
 - For a short-length card, pull the PCI card from the slot.
 - For a full-length card: Pull back on the PCI tail lock to release the PCI card. See the figure below. While holding the PCI tail lock back, pull out the PCI card.

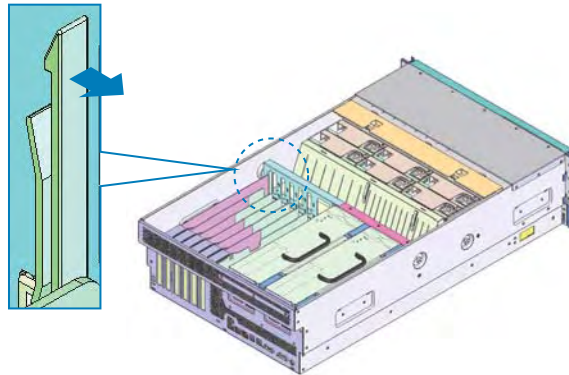

AF001143

Figure 59. Releasing the PCI Card from the Tail Lock

5. Insert the slot cover over the opening at the rear of the chassis.

Note: Be sure to insert a slot cover over any unused slot. An uncovered slot may affect the cooling system.

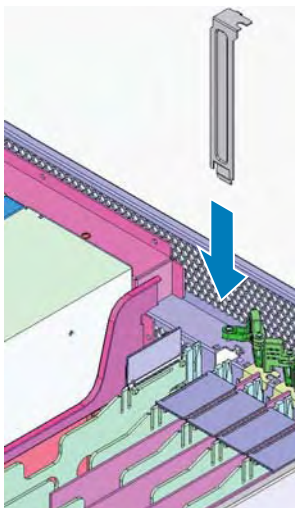

AF001147

Figure 60. Installing a PCI Slot Cover

6. Pull the PCI card lock until it locks into place. See the figure below.

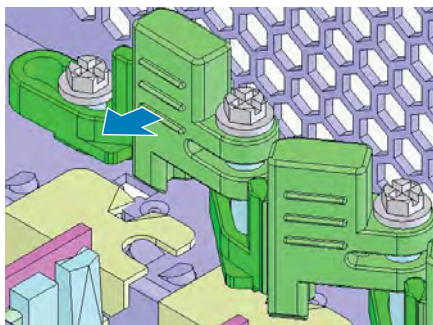

AF001142

Figure 61. Locking a PCI Card or Slot Cover into Place

7. Close the PCI caution plate. See the figure below.

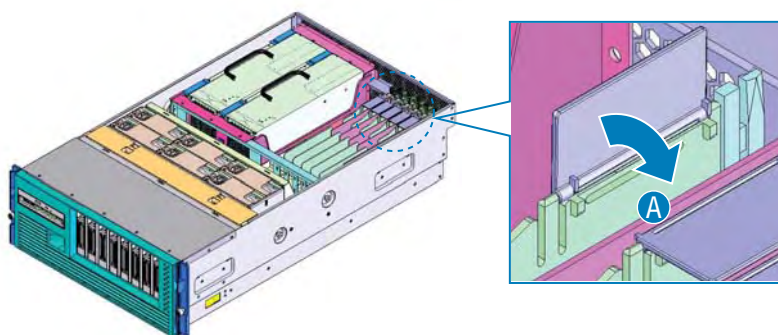

AF001144

Figure 62. Closing the PCI Caution Plate

8. Determine your next course of action and refer to the appropriate steps:
 - If you have removed a PCI card and need to replace it, see [“Installing a PCI Card” on page 59](#).
 - If you are following these steps as part of another procedure, return to that procedure.
 - If you are done working inside your server system, install the top cover. For instructions, see [“Installing the Top Cover” on page 37](#).

Hot-Plugging a PCI Card

To perform this procedure, you will first need to remove the top cover. The steps below will direct you to the instructions to remove the top cover at the appropriate location in the step sequence.

Caution: Use caution when installing the add-in card to avoid touching components on the card.

1. Remove the top cover. For instructions, see [“Removing the Top Cover”](#) on page 36.
2. Press the lens switch button PCI card you want to replace. Hold the button down for 5 or more seconds. See letter “B” in the figure below. To cancel this operation, press the lens switch again within five seconds of the first press.
3. Only if PCI card is installed in the slot: Confirm that the power LED state changes from green to blinking to off. See letter “A” in the figure. This step does not apply if a slot cover is installed instead of a PCI card.

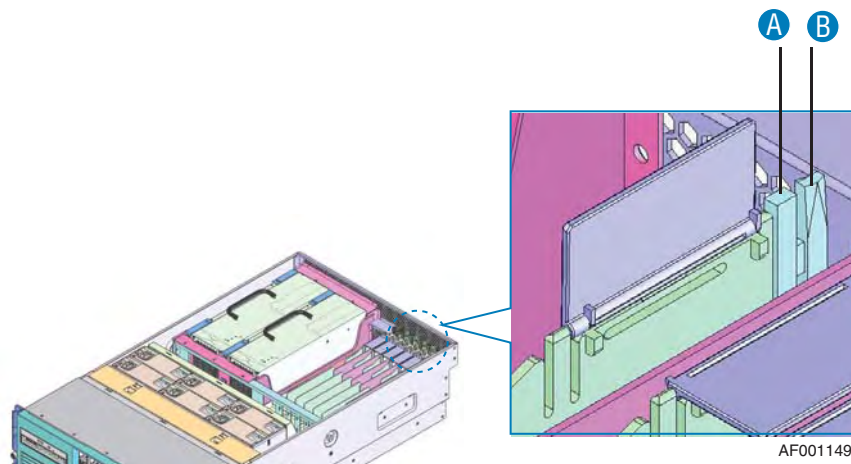

Figure 63. Locating the Lens Switch and PCI Card LED

4. Remove the PCI card or slot cover. See [“Removing a PCI Card”](#) on page 63, following steps 2 through 4. Then return to these steps.
5. Insert the new PCI card. For instructions, see [“Installing a PCI Card”](#) on page 59, following steps 6 through 9. Then return to these steps.
6. For five or more seconds, press the lens switch for the PCI card you want to replace. If you need to cancel this operation, press the button again within five seconds of the first press. This step is not necessary if a slot cover is installed instead of an add-in card.
7. Confirm that the power LED state changes from off to blinking to green. When the slot cover is inserted instead of PCI card, skip this operation.
8. Install the top cover. For instructions, see [“Installing the Top Cover”](#) on page 37.

Installing and Removing a Power Supply

Your system was shipped to you with two power supplies installed. Both power supplies must be installed and plugged in when a 110 V outlet is used. Hot-swapping is not available under this condition. One power supply can be used when it is connected to a 220 V outlet. Under this condition, a power supply can be hot-swapped if necessary.

The instructions below describe removing a power supply filler panel. The power supply filler panel would be used only if the power supply is connected to a 220 V outlet. If a power supply is removed and not replaced, a filler panel must be installed into the empty opening.

You will need to remove the power supplies to perform the following operations:

- To replace a power supply
- To install or remove the power supply box
- To install or remove the power supply support
- To install or remove the fan box
- To install or remove the PCI card divider
- To install or remove the air flow guide
- To install or remove the hard drive backplane
- To install or remove the mounting plate
- To install or remove a processor

Warning: *The power supply module has a high-voltage area in it. Do not open the power supply. It may result in electric shock or equipment failure.*

Installing a Power Supply

To perform this procedure, you will first need to remove the top cover. The steps below will direct you to the instructions to remove the top cover at the appropriate location in the step sequence.

Note: *Before performing the procedures in this section, except for when hot-swapping, turn off the system and then disconnect all power plugs.*

1. Remove the top cover. For instructions, see [“Removing the Top Cover” on page 36](#).
2. If a power supply filler panel is installed:
 - Loosen the captive screw on the power supply filler. See letter “A” in the figure below.
 - Lift the power supply filler from the system. See letter “B” in the figure. Save the filler for future use.

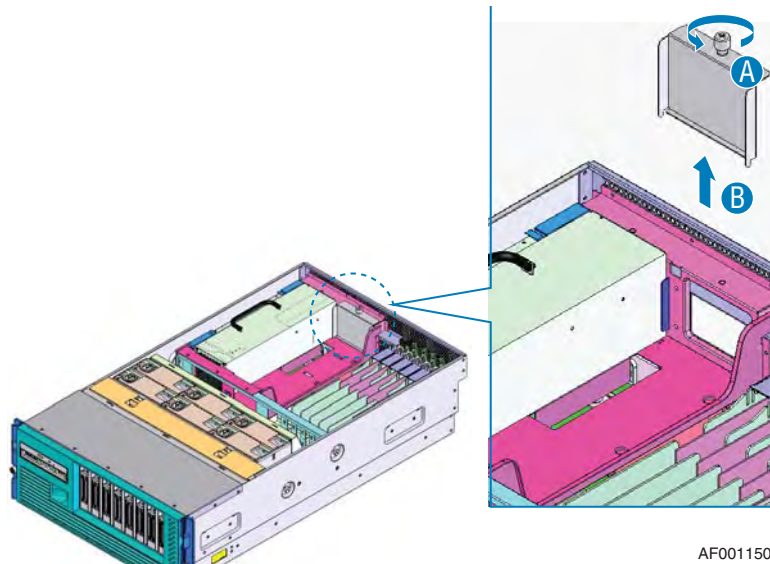

Figure 64. Removing a Power Supply Filler

3. Simultaneously push the two levers on the top of the power supply slightly outward and then raise them to unlock the power supply. See letter “A” in the following figure.
4. Use the handle on the power supply to lower it into the system. See letter “B” in the figure.

Caution: Do not lift the power supply by the levers. Lift the power supply only by the handle.

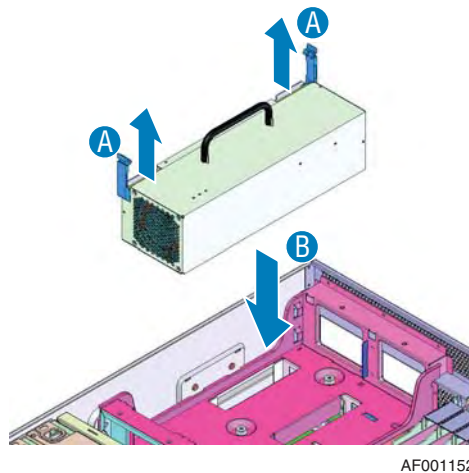
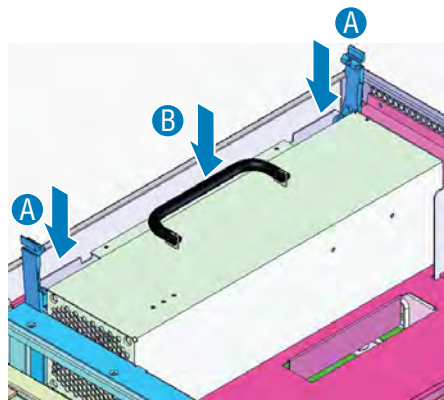

Figure 65. Installing a Power Supply

5. Push down the two levers on the top of the power supply to lock it into place. See letter “A” in the figure below.
6. Lower the handle on the power supply. See letter “B” in the figure.



AF001153

Figure 66. Locking the Power Supply into Place

7. Determine your next course of action and refer to the appropriate steps:
 - If you are following these steps as part of another procedure, return to that procedure.
 - If you are done working inside your server system, install the top cover. For instructions, see [“Installing the Top Cover” on page 37](#).

Removing a Power Supply

To perform this procedure, you will first need to remove the top cover. The steps below will direct you to the instructions to remove the top cover at the appropriate location in the step sequence.

Cautions:

- *Before performing the procedures in this section, except for when hot-swapping, turn off the system and then disconnect all power plugs.*
- *Care must be taken when you replace the power supply module; the cover or handle is hot when the system is powered on.*
- *Before removing the power supply, pull up two levers to release the connector between power supply and main board.*

1. Remove the top cover. For instructions, see “[Removing the Top Cover](#)” on page 36.
2. Simultaneously push the two levers on the top of the power supply slightly outward and then raise them to unlock the power supply. See letter “A” in the figure below.

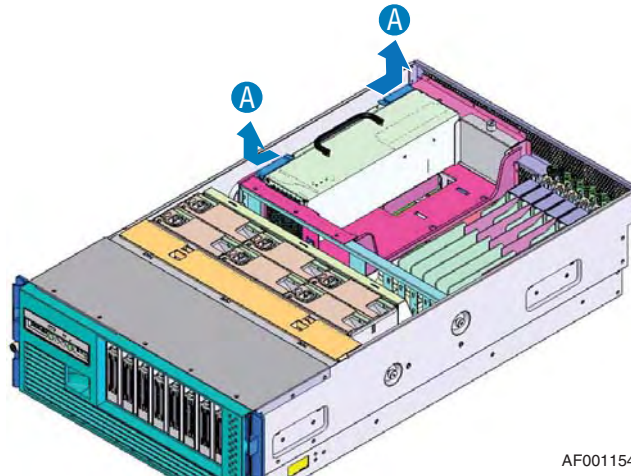

AF001154

Figure 67. Opening the Power Supply Levers

3. Use the handle to lift the power supply from the system. See the figure below.

Caution: Do not use the levers to lift or move the power supply. Only use the handle to lift the power supply.

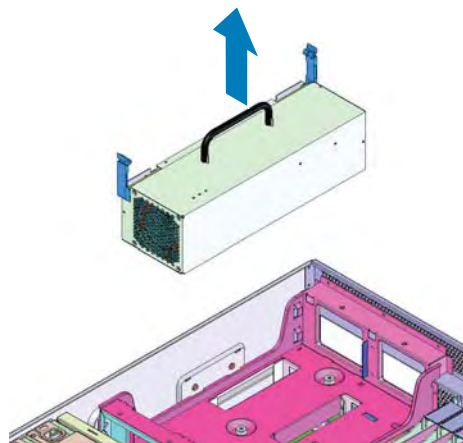

AF001155

Figure 68. Removing the Power Supply

4. If you are not installing a replacement power supply, insert the power supply filler panel (see letter “A” in the figure below) and tighten the captive screw to attach it to the open slot. See letter “B” in the figure.

Caution: Install a filler panel into any unused slot. An open slot will affect the system cooling.

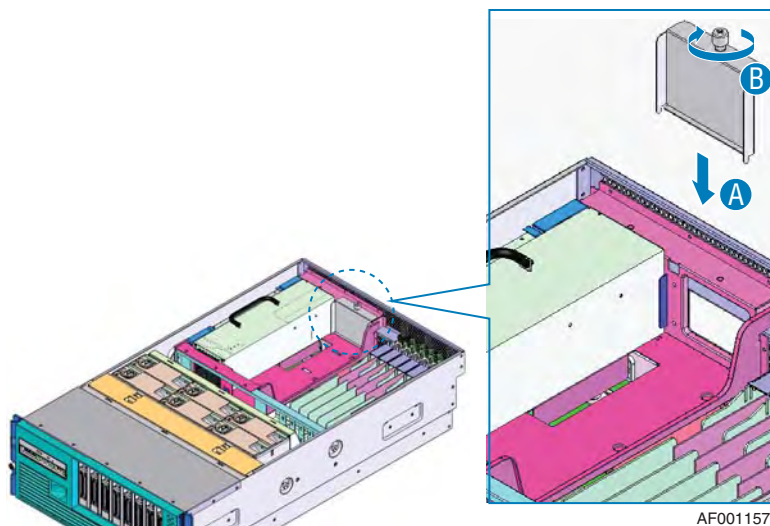

Figure 69. Installing a Power Supply Filler

5. Determine your next course of action and refer to the appropriate steps:
 - If you have removed your power supply and need to replace it, see [“Installing a Power Supply”](#) on page 68.
 - If you are following these steps as part of another procedure, return to that procedure.
 - If you are done working inside your server system, install the top cover. For instructions, see [“Installing the Top Cover”](#) on page 37.

Hot-swapping a Power Supply

To perform this procedure, you will first need to remove the top cover. The steps below will direct you to the instructions to remove the top cover at the appropriate location in the step sequence.

Cautions:

- *Be sure to remove only the failed component. Removing of an incorrect component could cause system to malfunction.*
- *A power supply cannot be hot swapped in the following configurations:*
 - *When input voltage is 100-127 V.*
 - *When only one power supply is installed.*

1. Remove the top cover. For instructions, see [“Removing the Top Cover”](#) on page 36.
2. Check the LED indicators on the power supplies. The red LED indicates the failed power supply.

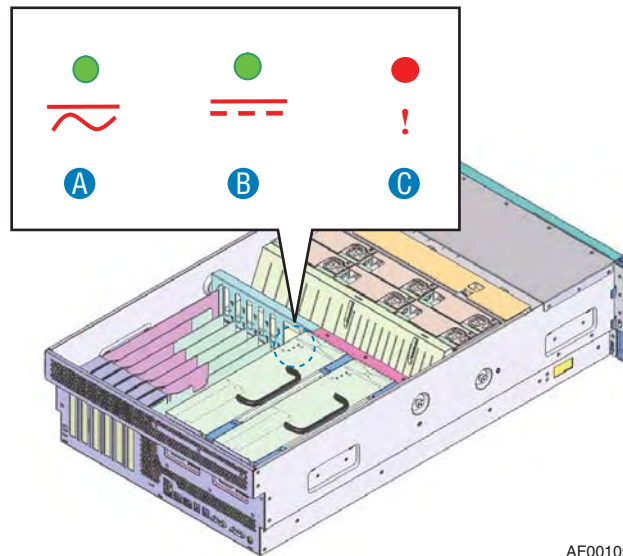

AF001090

A	Input Good LED	Indicates input power is good, when this green LED is on.
B	DC Output Good LED	Indicates output power is good, when this green LED is on.
C	Fault LED	Indicates the power supply has a fault.

Figure 70. Power Supply LED Indicators

3. Disconnect the power cable from the power supply you want to replace.
4. Remove the power supply. For instructions, see [“Removing a Power Supply” on page 70](#). Return to these steps after removing the power supply.
5. Install the new power supply. For instructions, see [“Installing a Power Supply” on page 68](#).
6. Install the top cover. For instructions, see [“Installing the Top Cover” on page 37](#).

Installing and Removing the Front Control Panel and Optical Drive Assembly

Removing the Front Control Panel and Optical Drive Assembly

Before beginning these steps, power down your server system and unplug all AC power cords.

To perform this procedure, you will first need to remove the front bezel. The steps below will direct you to the instructions to remove the front bezel at the appropriate location in the step sequence.

1. Remove the front bezel. For instructions, see [“Removing the Front Bezel” on page 34](#).
2. Push and hold the levers on each sides of the front control panel / DVD-ROM drive assembly. See letter “A” in the figure below.
3. Pull out the front control panel / optical drive assembly. See letter “B” in the figure.

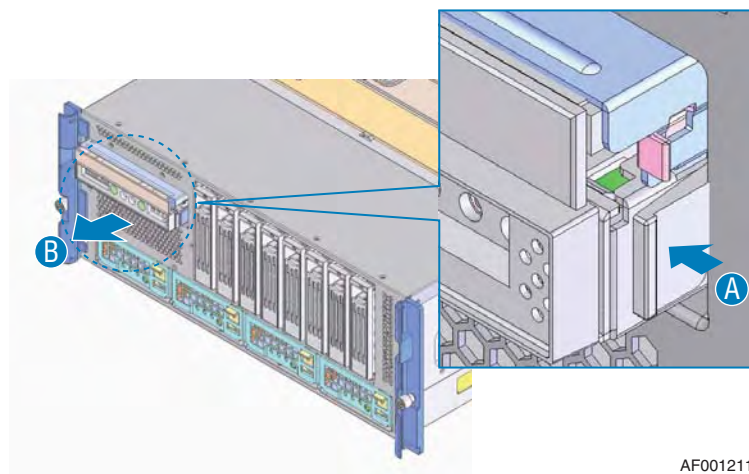

AF001211

Figure 71. Removing the Front Control Panel and Optical Drive Assembly

4. Determine your next course of action and refer to the appropriate steps:
 - If you have removed your front control panel / optical drive assembly and need to replace it, see [“Installing the Front Control Panel and Optical Drive Assembly” on page 75](#).
 - If you are following these steps as part of another procedure, return to that procedure.

Installing the Front Control Panel and Optical Drive Assembly

These steps assume you have removed your front control panel and optical drive assembly, your server system is currently powered down, and your front bezel is removed.

1. Slide the front control panel / optical drive assembly in through the front of the chassis as shown in the left figure below.
2. Push the assembly firmly until it clicks into place.

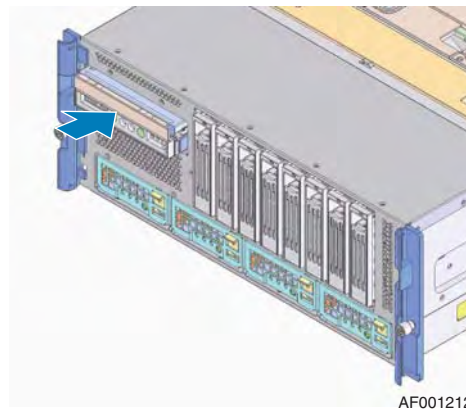

Figure 72. Installing the Front Control Panel and Optical Drive Assembly

3. Determine your next course of action and refer to the appropriate steps:
 - If you are following these steps as part of another procedure, return to that procedure.
 - Install the front bezel. For instructions, see [“Installing the Front Bezel” on page 35](#).

Installing and Removing the Power Supply Box

Before beginning these steps, power down your server system and unplug all AC power cords.

You will need to remove the power supply box to perform the following operations:

- To install or remove the power supply support
- To install or remove the fan box
- To install or remove the PCI card divider
- To install or remove the air flow guide
- To install or remove the hard drive backplane
- To install or remove the mounting plate
- To install or remove a processor

Removing the Power Supply Box

To perform this procedure, you first need to remove:

- The top cover. For instructions, see [“Removing the Top Cover” on page 36](#).
- All installed power supplies. For instructions, see [“Removing a Power Supply” on page 70](#).
- The power supply filler panel, if one is installed. For instructions, see [“Installing a Power Supply” on page 68](#). Follow step 2 only.

Remove these components, in order, before beginning the steps below.

The steps below do not guide you through reinstalling the components you are removing or disconnecting in this step sequence. These steps assume you are removing the power supply box to either replace it, or to access another component. After completing these steps, continue with the steps that directed you to this section, or follow the steps under [“Installing the Power Supply Box” on page 80](#) to replace your power supply box.

1. Disconnect the CPU1 / CPU2 MVR cable from the main board. To disconnect this cable, press and hold the latch on the cable connector while pulling on the connector. See the figure below to locate the MVR cable connection.



AF001431

Figure 73. Locating the CPU1 / CPU2 MVR Connection

2. Disconnect the IDE cable from the main board. See letter “A” in the figure below.
3. Disconnect the SAS4I cable from the main board. To disconnect the cable, press both ends of the cable to be unlocked, and then disconnect it. See letter “B” in the figure.
4. Remove the cables from the clips at the top of the power supply box. See letters “C” and “D” in the figure.

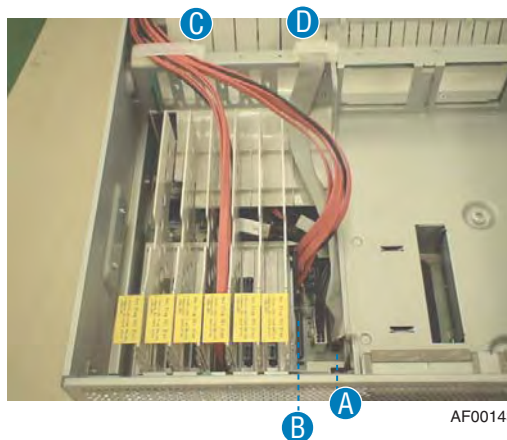

AF001432

Figure 74. Disconnecting the IDE and SATA Cables

5. Loosen the two captive screws on the exterior of the system. One screw is on each side of the system. See the figure below.

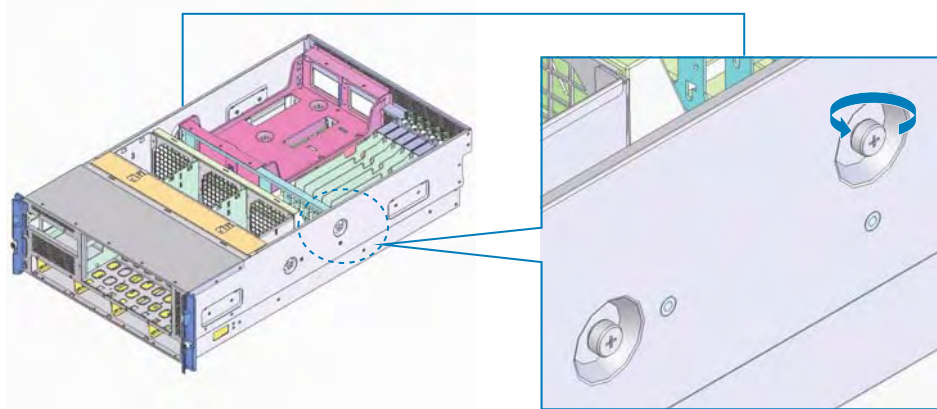

AF001213

Figure 75. Loosening the Exterior Captive Screws

6. Loosen the two captive screws inside the system. See the figure below.

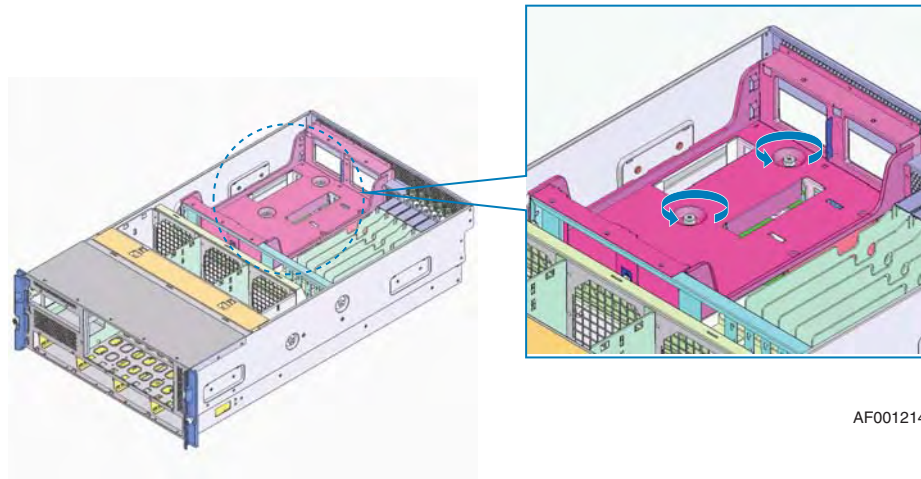

AF001214

Figure 76. Loosening the Interior Captive Screws

7. Lift up the front end of the power supply box first, then lift the power supply box from the system. See the figure below.

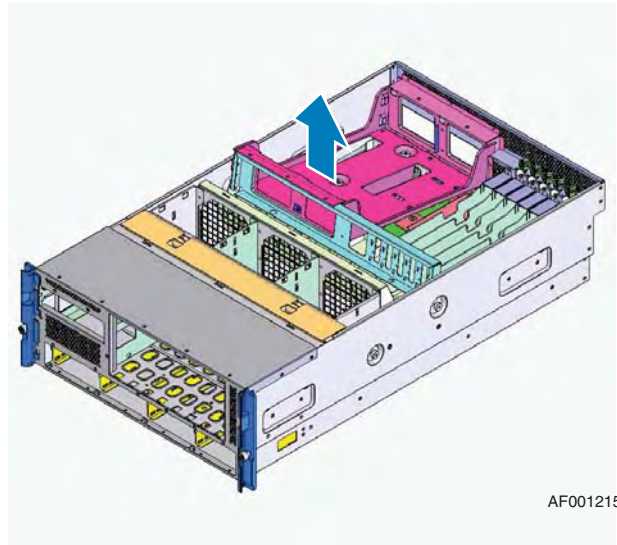

Figure 77. Lifting the Power Supply Box from System

8. Determine your next course of action and refer to the appropriate steps:
 - If you are following these steps as part of another procedure, return to that procedure.
 - If you are replacing your power supply box, continue with [“Installing the Power Supply Box”](#) on page 80.

Installing the Power Supply Box

These steps assume you have just removed the power supply box, as described in “Removing the Power Supply Box” on page 76 and your system is partially disassembled.

1. Set the rear of the power supply box into the chassis, ensuring that the two slots in the chassis align with the corresponding hooks on each end of the power supply box assembly, as shown in the figure below.

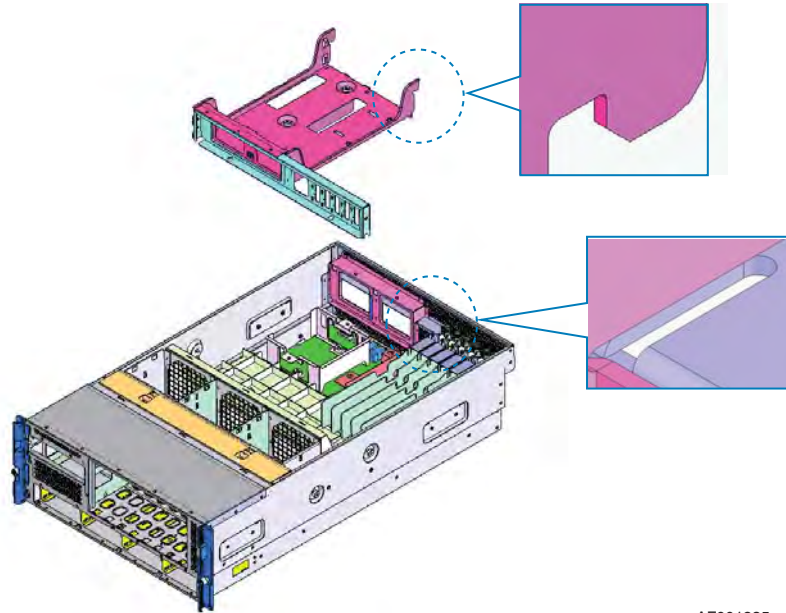

Figure 78. Inserting the Rear of Power Supply Box

2. Press down on the front of the power supply box to set it into place.

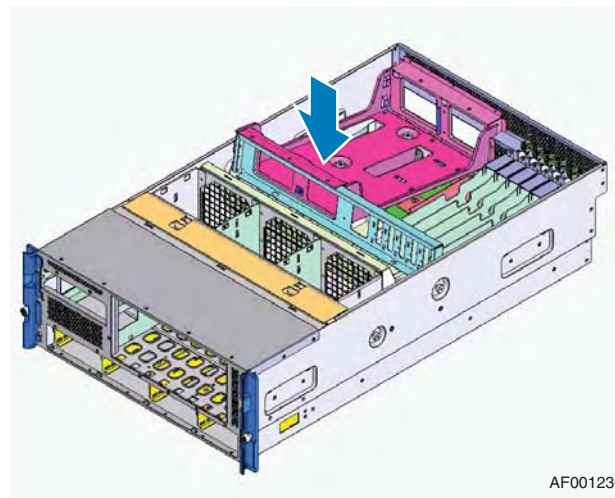

Figure 79. Setting the Front of the Power Supply Box into Place

3. Tighten the two captive screws at the bottom of the power supply box. See the figure below.

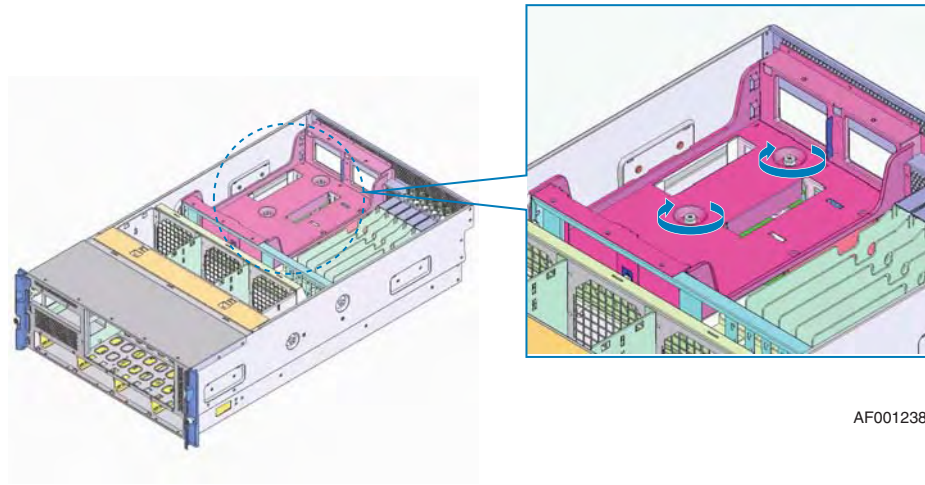

Figure 80. Tightening the Internal Power Supply Box Screws

4. Tighten the two screws on the exterior of the system. One screw is on each side of the system, as shown below.

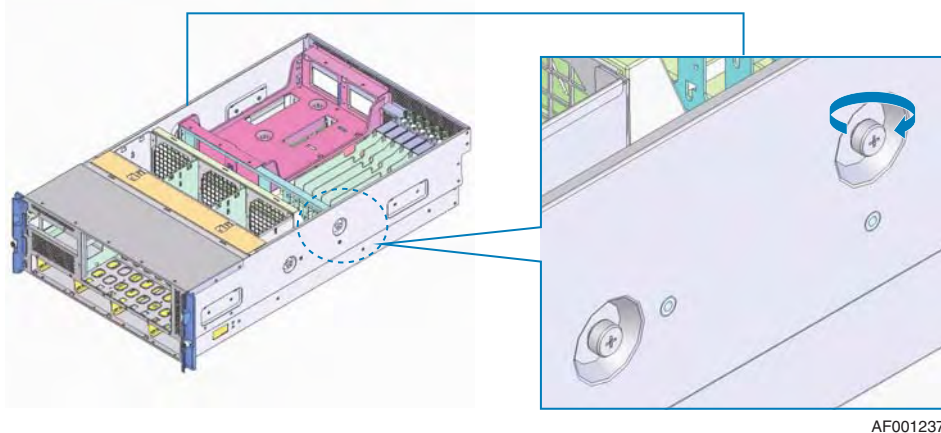

Figure 81. Tightening the External Power Supply Box Screws

5. Connect the CPU1 / CPU2 MVR cable from the main board. See the figure below to locate the MVR cable connection.



AF001431

Figure 82. Locating the CPU1 / CPU2 MVR Connection

6. Connect the IDE cable from the main board. See letter “A” in the figure below.
7. Connect the SAS4I cable from the main board. To disconnect the cable, press both ends of the cable to be unlocked, and then disconnect it. See letter “B” in the figure.
8. Insert the cables into the clips at the top of the power supply box. See letters “C” and “D” in the figure.

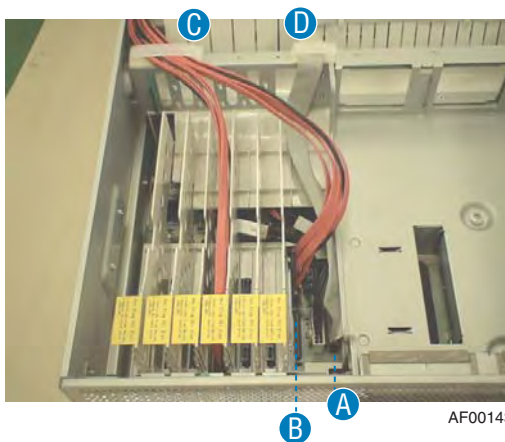

AF001432

Figure 83. Connecting the IDE and SATA Cables

9. Determine your next course of action and refer to the appropriate steps:
 - If you are following these steps as part of another procedure, return to that procedure.
 - If you are ready to re-assemble your server system, install the following items, in order:
 - ✧ All installed power supplies. For instructions, see [“Installing a Power Supply” on page 68](#).
 - ✧ The power supply filler panel, if necessary. For instructions, see [“Removing a Power Supply” on page 70](#). Follow step 4 only.
 - ✧ The top cover. For instructions, see [“Installing the Top Cover” on page 37](#).

Installing and Removing the Power Supply Support

Before beginning these steps, power down your server system and unplug all AC power cords.

You will need to remove the top cover to perform the following operation:

- To install or remove the mounting plate

Removing the Power Supply Support

To perform this procedure, you will first need to remove:

- The top cover. For instructions, see [“Removing the Top Cover” on page 36](#).
- All installed power supplies. For instructions, see [“Removing a Power Supply” on page 70](#).
- The power supply filler panel, if one is installed. For instructions, see [“Installing a Power Supply” on page 68](#). Follow step 2 only.
- The power supply box. For instructions, see [“Removing the Power Supply Box” on page 76](#).

Remove these components, in order, before beginning the steps below.

The steps below do not guide you through reinstalling the components you are removing or disconnecting in this step sequence. These steps assume you are removing the power supply support to either replace it, or to access another component. After completing these steps, continue with the steps that directed you to this section, or follow the steps under [“Installing the Power Supply Support” on page 85](#) to replace your power supply support.

1. Loosen the two screws that hold the power supply support in place. See the figure below.

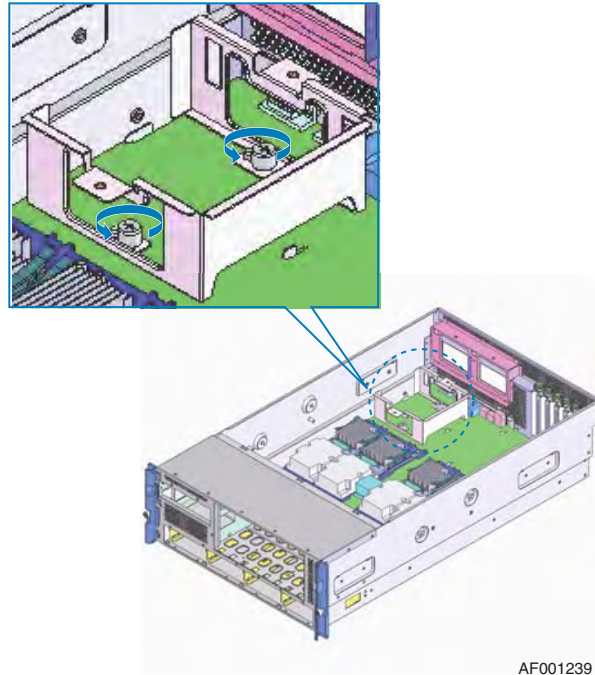

Figure 84. Loosening the Power Supply Support Captive Screws

2. Lift the power supply support to remove it from the system. See the figure below.

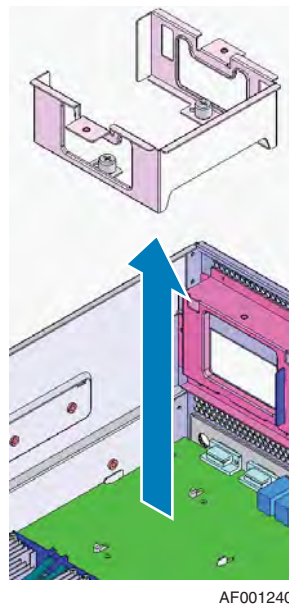

Figure 85. Lifting the Power Supply Support from System

3. Determine your next course of action and refer to the appropriate steps:
 - If you are following these steps as part of another procedure, return to that procedure.
 - Install a replacement power supply support. For instructions, see [“Installing the Power Supply Support”](#) on page 85.

Installing the Power Supply Support

These steps assume you have removed the power supply support, as described in [“Removing the Power Supply Support”](#) on page 83 and your system is partially disassembled.

1. Set the power supply support into place in the system, lining up the guide pins in the chassis with the corresponding guide holes in the power supply support. See the figure below.

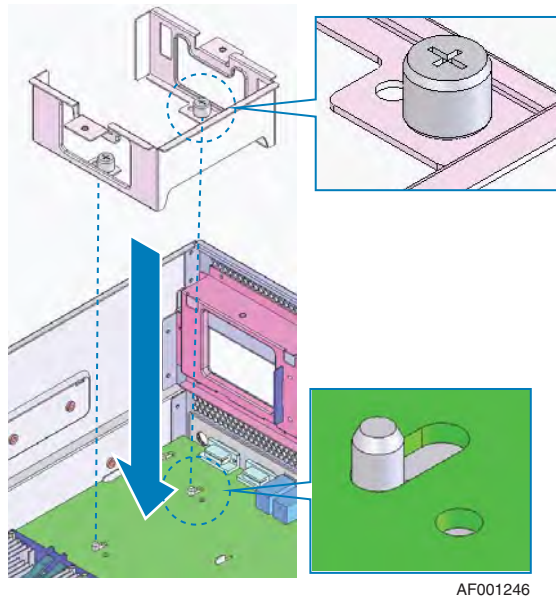

Figure 86. Setting the Power Supply Support into Place

2. Tighten the two captive screws at the bottom of the power supply support. See the figure below.

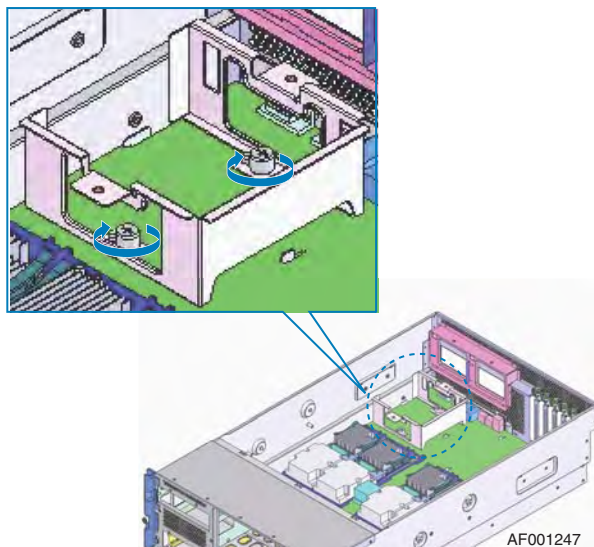

Figure 87. Tightening the Power Supply Support Screws

3. Determine your next course of action and refer to the appropriate steps:
 - If you are following these steps as part of another procedure, return to that procedure.
 - If you are ready to re-assemble your server system, install the following items, in order:
 - ❖ The power supply box. For instructions, see [“Installing the Power Supply Box” on page 80](#).
 - ❖ All installed power supplies. For instructions, see [“Installing a Power Supply” on page 68](#).
 - ❖ The power supply filler panel, if necessary. For instructions, see [“Removing a Power Supply” on page 70](#). Follow step 4 only.
 - ❖ The top cover. For instructions, see [“Installing the Top Cover” on page 37](#).

Installing and Removing the Hard Drive Backplane Cover

Before beginning these steps, power down your server system and unplug all AC power cords.

You will need to remove the hard drive backplane cover to perform the following operations:

- To install or remove the fan box
- To install or remove the hard drive backplane
- To install or remove the mounting plate

Removing the Hard Drive Backplane Cover

Before beginning these steps, you must remove the top cover from the system. For instructions, see [“Removing the Top Cover”](#) on page 36.

1. Use the finger grip and lever to pull and hold the two levers at the top of the hard drive backplane cover.
2. Pull the backplane cover from the system.

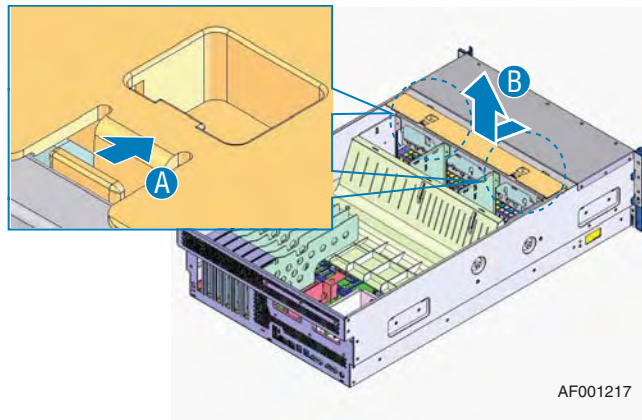

Figure 88. Removing the Hard Drive Backplane Cover

3. Determine your next course of action and refer to the appropriate steps:
 - If you are following these steps as part of another procedure, return to that procedure.
 - Reinstall the hard drive backplane cover. For instructions, see [“Installing the Hard Drive Backplane Cover”](#) on page 88.

Installing the Hard Drive Backplane Cover

These steps assume the top cover is already removed from the system.

1. Set the hard drive backplane cover into the chassis, inserting the three tabs on the backplane cover through the slots in the chassis, as shown in the figure below.

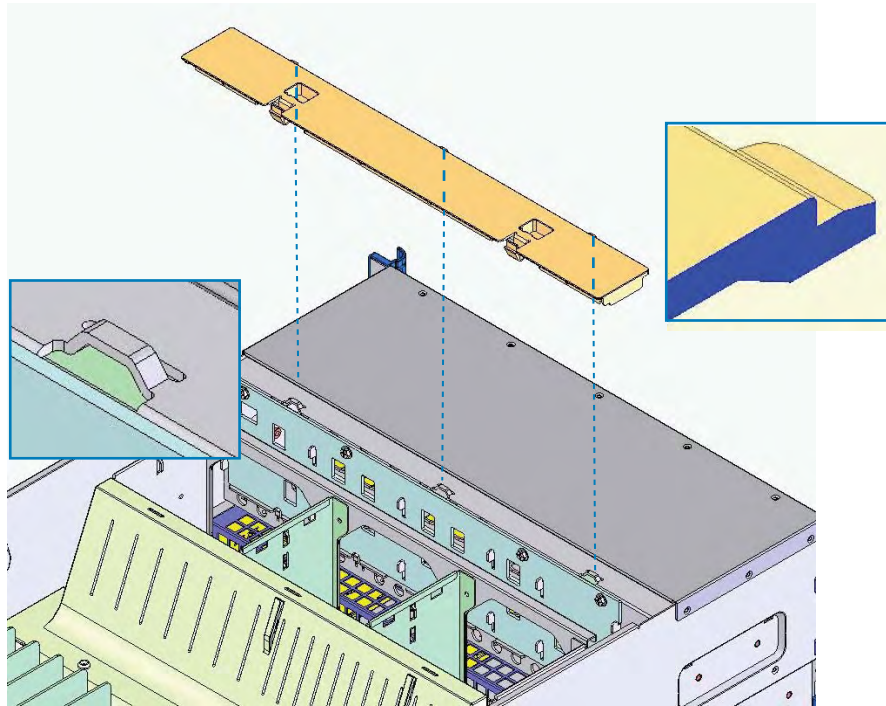

AF001233

Figure 89. Installing the Hard Drive Backplane Cover

2. Push down on the backplane cover until it snaps into place.
3. Verify that two levers on top are latched, as shown by letter “A” below.

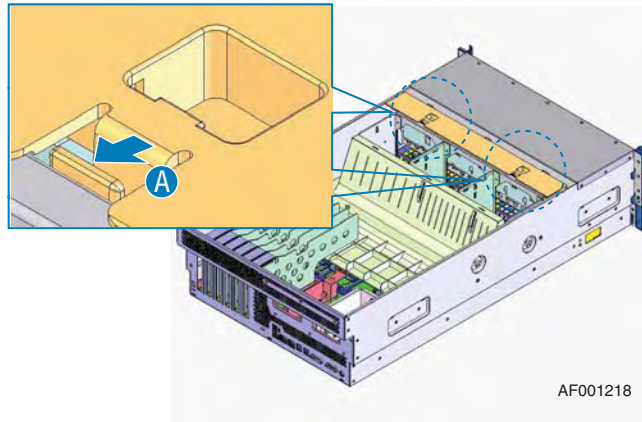

Figure 90. Checking the Backplane Cover Latches

4. Determine your next course of action and refer to the appropriate steps:
 - If you are following these steps as part of another procedure, return to that procedure.
 - Install the top cover. For instructions, see [“Installing the Top Cover” on page 37](#).

Installing and Removing the KVM Card

Before beginning these steps, power down your server system and unplug all AC power cords.

You will need to remove the KVM card to perform the following operations:

- To replace the KVM card
- To remove the PCI card divider

Removing the KVM Card

To perform this procedure, you will first need to remove:

- The top cover. For instructions, see [“Removing the Top Cover” on page 36](#).
- All installed power supplies. For instructions, see [“Removing a Power Supply” on page 70](#).
- The power supply filler panel, if one is installed. For instructions, see [“Installing a Power Supply” on page 68](#). Follow step 2 only.
- The power supply box. For instructions, see [“Removing the Power Supply Box” on page 76](#).

Remove these components, in order, before beginning the steps below.

The steps below do not guide you through reinstalling the components you are removing or disconnecting in this step sequence. These steps assume you are removing the KVM card to either replace it, or to access another component. After completing these steps, continue with the steps that directed you to this section, or follow the steps under [“Installing the KVM Card” on page 90](#) to replace your KVM card.

Pull straight up on the KVM card to remove it from the socket. See the figure below.

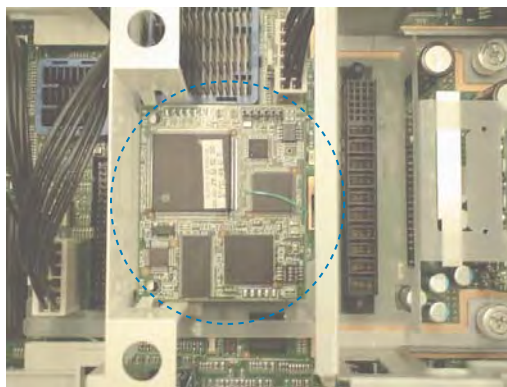

AF001433

Figure 91. Locating the KVM Card

Installing the KVM Card

If this is a first-time installation of the KVM card (you are not replacing a KVM card), you first need to remove several components to access the KVM card socket. Before beginning these steps, you must first remove the following items:

- The top cover. For instructions, see [“Removing the Top Cover” on page 36](#).
- All installed power supplies. For instructions, see [“Removing a Power Supply” on page 70](#).
- The power supply filler panel, if one is installed. For instructions, see [“Installing a Power Supply” on page 68](#). Follow step 2 only.
- The power supply box. For instructions, see [“Removing the Power Supply Box” on page 76](#).

Remove these components, in order, before beginning the steps below.

1. Line up the KVM card with the socket on the server board. Press the card firmly into place. Use caution so you do not bend or twist the KVM card.

2. Determine your next course of action and refer to the appropriate steps:
 - If you are following these steps as part of another procedure, return to that procedure.
 - If you are ready to re-assemble your server system, install the following items, in order:
 - ✧ The power supply box. For instructions, see [“Installing the Power Supply Box” on page 80](#).
 - ✧ All installed power supplies. For instructions, see [“Installing a Power Supply” on page 68](#).
 - ✧ The power supply filler panel, if necessary. For instructions, see [“Removing a Power Supply” on page 70](#). Follow step 4 only.
 - ✧ The top cover. For instructions, see [“Installing the Top Cover” on page 37](#).

Installing and Removing the PCI Card Divider

Before beginning these steps, power down your server system and unplug all AC power cords.

You will need to remove the PCI card divider to perform the following operations:

- To install or remove the fan box
- To install or remove the air flow guide
- To install or remove the hard drive backplane
- To install or remove the mounting plate
- To install or remove a processor

Removing the PCI Card Divider

To perform this procedure, you will first need to remove:

- The top cover. For instructions, see [“Removing the Top Cover” on page 36](#).
- All installed power supplies. For instructions, see [“Removing a Power Supply” on page 70](#).
- The power supply filler panel, if one is installed. For instructions, see [“Installing a Power Supply” on page 68](#). Follow step 2 only.
- The power supply box. For instructions, see [“Removing the Power Supply Box” on page 76](#).
- The KVM card, if it is installed. For instructions, see [“Removing the KVM Card” on page 89](#).
- All installed PCI cards. For instructions, see [“Removing a PCI Card” on page 63](#).

Remove these components, in order, before beginning the steps below.

The steps below do not guide you through reinstalling the components you are removing or disconnecting in this step sequence. These steps assume you are removing the PCI card divider to either replace it, or to access another component. After completing these steps, continue with the steps that directed you to this section, or follow the steps under [“Installing the PCI Card Divider” on page 93](#) to replace your PCI card divider.

1. Pull the lever on the PCI card divider to unlatch the assembly from the system. The lever is located at the right side of the system, in front of PCI slot 1. See letter “A” in the figure below.
2. Pull the PCI card divider from the system. See letter “B” in the figure.

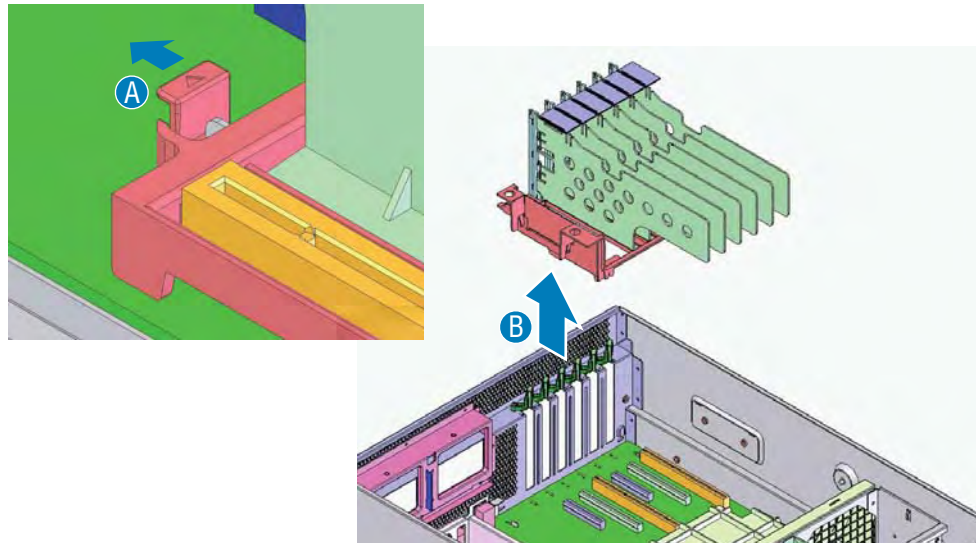

Figure 92. Removing the PCI Card Divider

3. Determine your next course of action and refer to the appropriate steps:
 - If you are following these steps as part of another procedure, return to that procedure.
 - Reinstall the PCI card divider. For instructions, see [“Installing the PCI Card Divider” on page 93](#).

Installing the PCI Card Divider

These steps assume you have just removed the PCI card divider, as described in “Removing the PCI Card Divider” on page 91 and your system is partially disassembled.

1. Insert the two guides of the PCI divider into two guide holes near the bottom of the system.
2. Verify that the guides align with the guide holes in the chassis. Press down on the divider until it snaps into place.

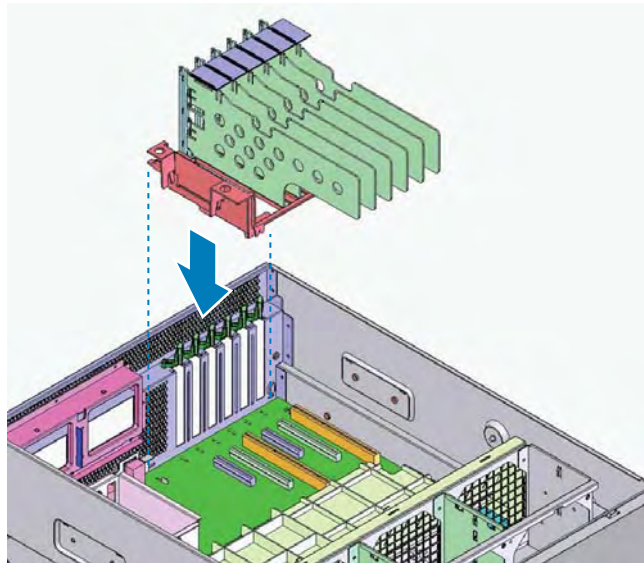

AF001232

Figure 93. Installing the PCI Divider

3. Install the CPU1 / CPU2 MVR cable. See the figure below to locate the connection point on the server board.



AF001431

Figure 94. Locating the CPU1 / CPU2 MVR Connection

4. Determine your next course of action and refer to the appropriate steps:
 - If you are following these steps as part of another procedure, return to that procedure.
 - If you are ready to re-assemble your server system, install the following items, in order:
 - ❖ The KVM card, if necessary. For instructions, see [“Installing the KVM Card” on page 90](#).
 - ❖ All installed PCI cards. For instructions, see [“Installing a PCI Card” on page 59](#).
 - ❖ The hard drive backplane cover. For instructions, see [“Installing the Hard Drive Backplane Cover” on page 88](#).
 - ❖ The power supply box. For instructions, see [“Installing the Power Supply Box” on page 80](#).
 - ❖ All installed power supplies. For instructions, see [“Installing a Power Supply” on page 68](#).
 - ❖ The power supply filler panel, if necessary. For instructions, see [“Removing a Power Supply” on page 70](#). Follow step 4 only.
 - ❖ The top cover. For instructions, see [“Installing the Top Cover” on page 37](#).

Installing and Removing the Air Flow Guide

Before beginning these steps, power down your server system and unplug all AC power cords.

You will need to remove the airflow guide to complete the following procedures:

- To install or remove the fan box
- To install or remove the hard drive backplane cover
- To install or remove the hard drive backplane
- To install or remove the mounting plate
- To install or remove a processor

Removing the Air Flow Guide

To perform this procedure, you will first need to remove:

- The top cover. For instructions, see [“Removing the Top Cover” on page 36](#).
- All installed power supplies. For instructions, see [“Removing a Power Supply” on page 70](#).
- The power supply filler panel, if one is installed. For instructions, see [“Installing a Power Supply” on page 68](#). Follow step 2 only.
- The power supply box. For instructions, see [“Removing the Power Supply Box” on page 76](#).
- The KVM card, if it is installed. For instructions, see [“Removing the KVM Card” on page 89](#).
- All installed PCI cards. For instructions, see [“Removing a PCI Card” on page 63](#).
- The PCI card divider. For instructions, see [“Removing the PCI Card Divider” on page 91](#).

Remove these components, in order, before beginning the steps below.

The steps below do not guide you through reinstalling the components you are removing or disconnecting in this step sequence. These steps assume you are removing the air flow guide to either replace it, or to access another component. After completing these steps, continue with the steps that directed you to this section, or follow the steps under [“Installing the Air Flow Guide” on page 97](#) to replace your air flow guide.

1. Pull the air flow guide upward to remove it from the system. See the figure below.

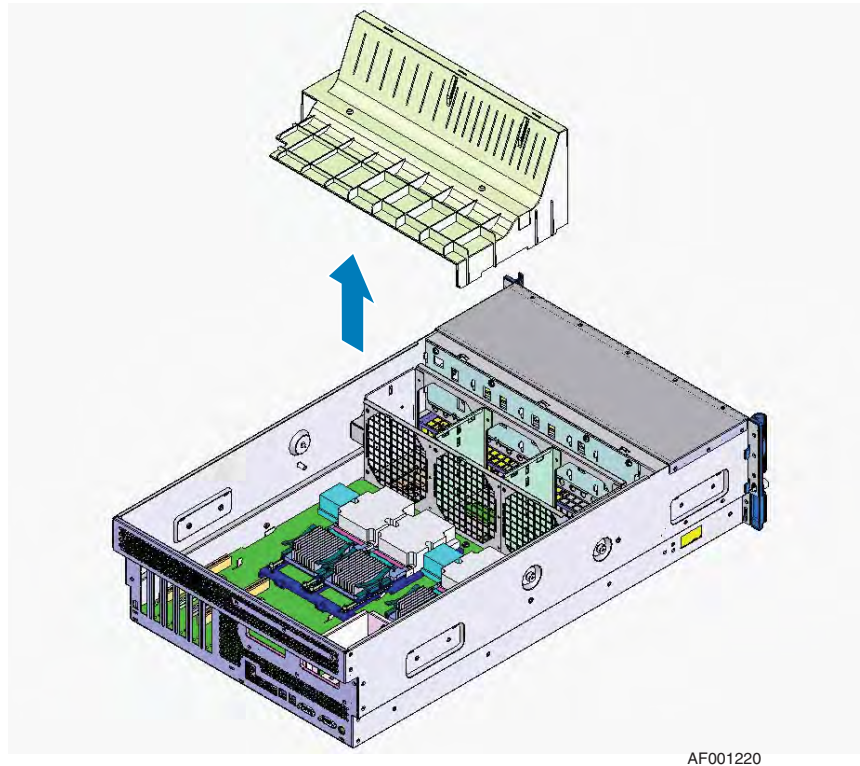

AF001220

Figure 95. Removing the Air Flow Guide

2. Determine your next course of action and refer to the appropriate steps:
 - If you are following these steps as part of another procedure, return to that procedure.
 - Reinstall the air flow guide. For instructions, see [“Installing the Air Flow Guide” on page 97](#).

Installing the Air Flow Guide

These steps assume you have removed the air flow guide, as described in “[Removing the Air Flow Guide](#)” on page 95 and your system is partially disassembled.

1. Place the air flow guide in the chassis.
2. Verify all three hooks in the chassis align with the corresponding three slots in the air flow guide as shown in the figure below.

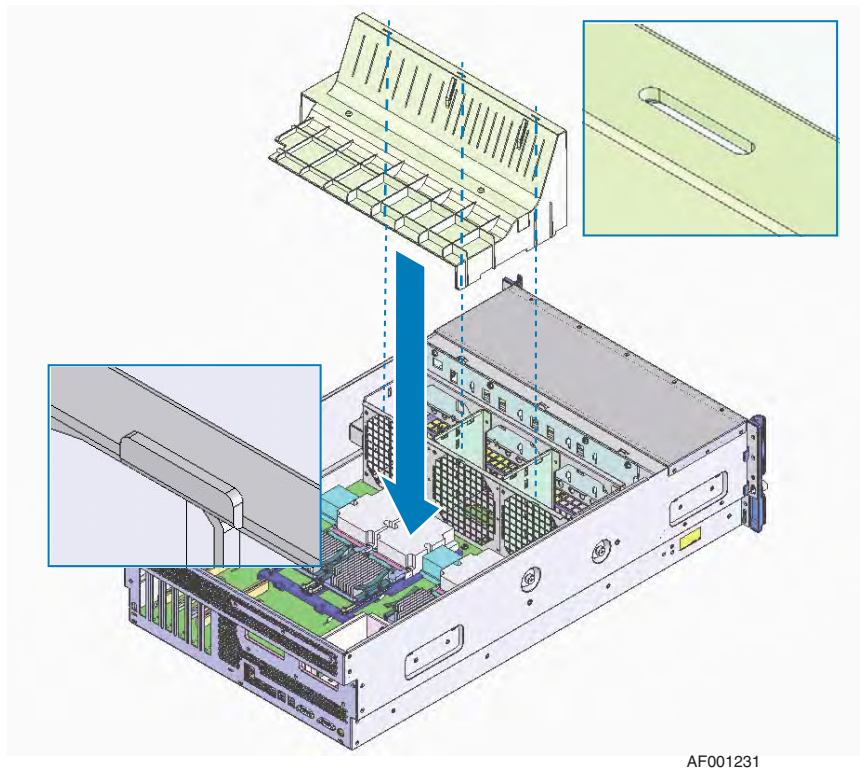

Figure 96. Installing the Air Flow Guide

3. Route loose cables through the cable guides at the rear of the air flow guide.
4. Determine your next course of action and refer to the appropriate steps:
 - If you are following these steps as part of another procedure, return to that procedure.
 - If you are ready to re-assemble your server system, install the following items, in order:
 - ✦ The PCI card divider. For instructions, see “[Installing the PCI Card Divider](#)” on page 93.

- ✧ The KVM card, if necessary. For instructions, see [“Installing the KVM Card” on page 90](#).
- ✧ All installed PCI cards. For instructions, see [“Installing a PCI Card” on page 59](#).
- ✧ The hard drive backplane cover. For instructions, see [“Installing the Hard Drive Backplane Cover” on page 88](#).
- ✧ The power supply box. For instructions, see [“Installing the Power Supply Box” on page 80](#).
- ✧ All installed power supplies. For instructions, see [“Installing a Power Supply” on page 68](#).
- ✧ The power supply filler panel, if necessary. For instructions, see [“Removing a Power Supply” on page 70](#). Follow step 4 only.
- ✧ The top cover. For instructions, see [“Installing the Top Cover” on page 37](#).

Installing and Removing the Fan Box

Before beginning these steps, power down your server system and unplug all AC power cords.

You will need to remove the fan box to perform the following operations:

- To install or remove the hard drive backplane
- To install or remove the mounting plate

Removing the Fan Box

To perform this procedure, you will first need to remove:

- The top cover. For instructions, see [“Removing the Top Cover” on page 36](#).
- All installed power supplies. For instructions, see [“Removing a Power Supply” on page 70](#).
- The power supply filler panel, if one is installed. For instructions, see [“Installing a Power Supply” on page 68](#). Follow step 2 only.
- The power supply box. For instructions, see [“Removing the Power Supply Box” on page 76](#).
- The hard drive backplane cover. For instructions, see [“Removing the Hard Drive Backplane Cover” on page 87](#).
- The KVM card, if it is installed. For instructions, see [“Removing the KVM Card” on page 89](#).
- All installed PCI cards. For instructions, see [“Removing a PCI Card” on page 63](#).
- The PCI card divider. For instructions, see [“Removing the PCI Card Divider” on page 91](#).

- The air flow guide. For instructions, see [“Removing the Air Flow Guide” on page 95](#).
- All installed fans. For instructions, see [“Removing a Fan” on page 57](#).

Remove these components, in order, before beginning the steps below.

The steps below do not guide you through reinstalling the components you are removing or disconnecting in this step sequence. These steps assume you are removing the fan box to either replace it, or to access another component. After completing these steps, continue with the steps that directed you to this section, or follow the steps under [“Installing the Fan Box” on page 101](#) to replace your fan box.

1. Loosen one screw on each side of the system, as shown by letter “A” in the figure below.

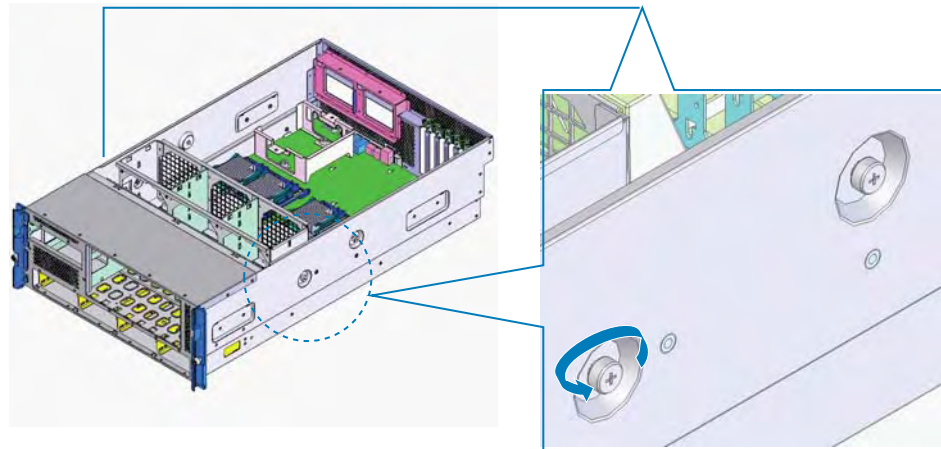

AF001221

Figure 97. Loosening the Exterior Screws

2. Loosen the two captive screws on the interior of the system, as shown by the figure below.

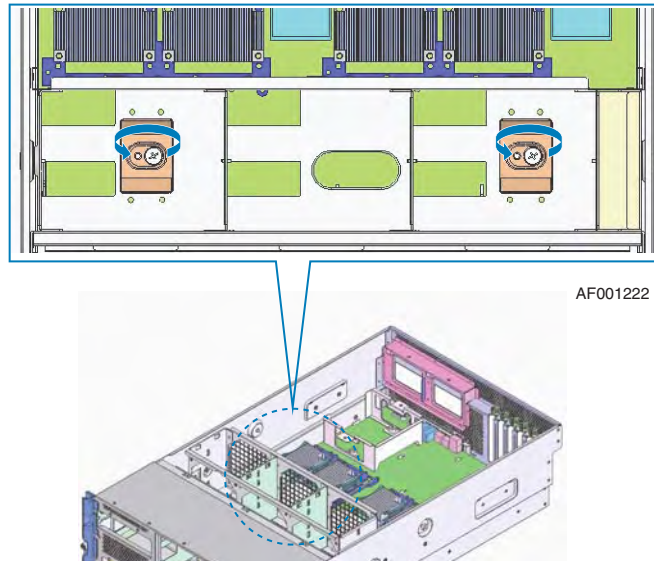

Figure 98. Loosening the Interior Screws

3. Lift the fan box from the system, as shown below.

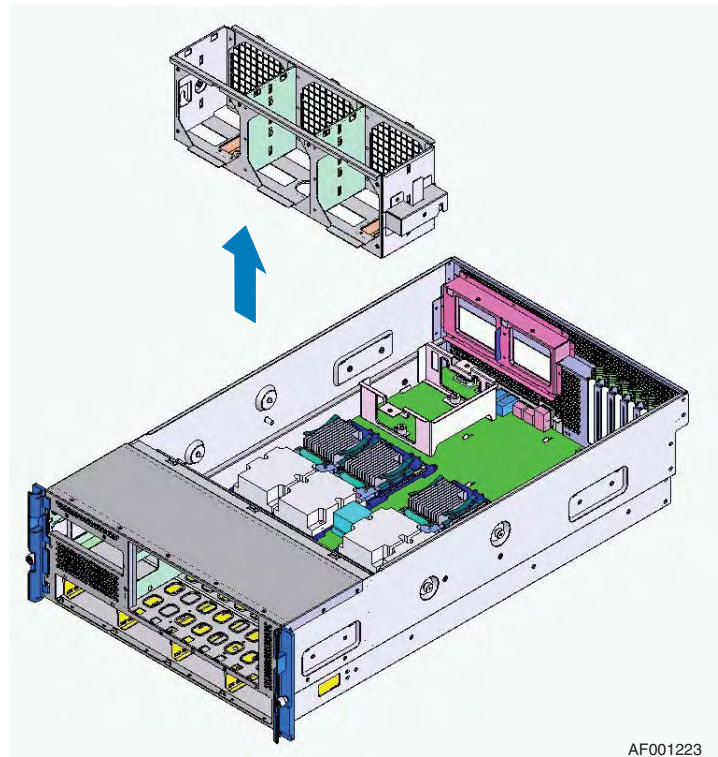

Figure 99. Lifting the Fan Box from the System

4. Determine your next course of action and refer to the appropriate steps:
 - If you are following these steps as part of another procedure, return to that procedure.
 - Reinstall the fan box. For instructions, see [“Installing the Fan Box”](#) on page 101.

Installing the Fan Box

These steps assume you have removed the air flow guide, as described in [“Removing the Air Flow Guide”](#) on page 95 and your system is partially disassembled.

1. Place the fan box in the chassis, lining up the two guide pins at the side of the chassis with the notches at the sides of the fan box, and lining up the two guide pins in the bottom of the chassis with the two holes in the bottom of the fan box as shown in the figure below.

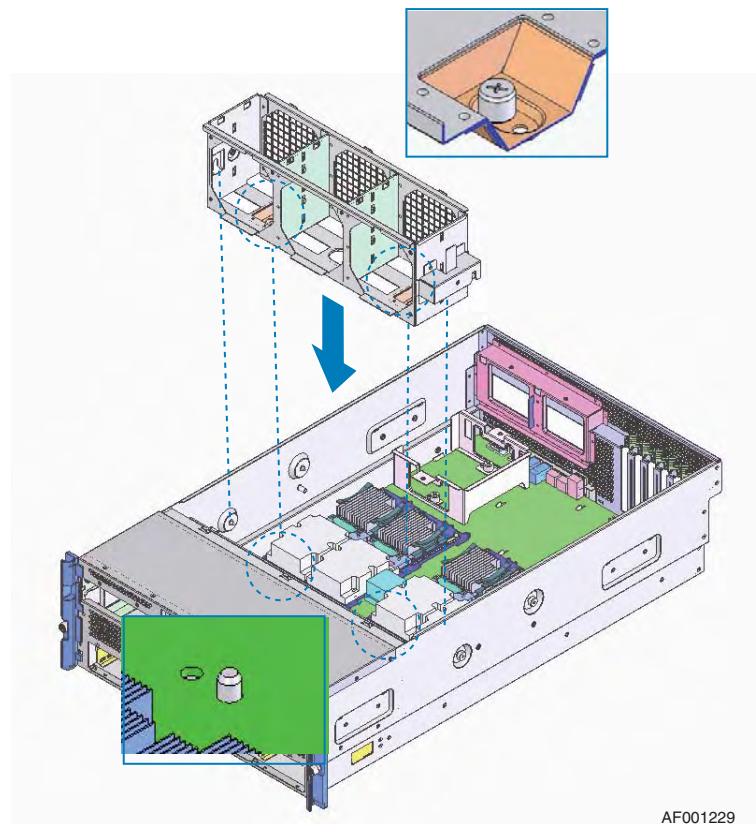

AF001229

Figure 100. Installing the Fan Box

2. Tighten the two screws at the bottom of the fan box, as shown by the figure below.

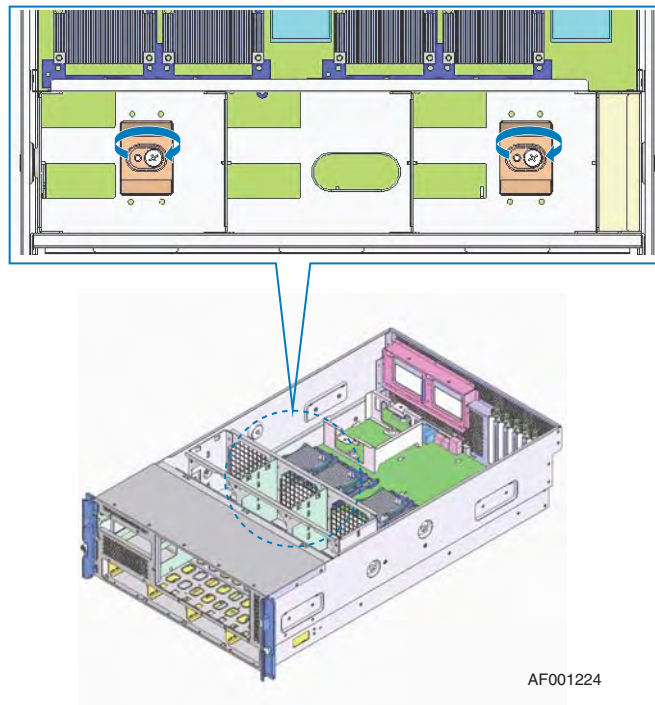

Figure 101. Tightening the Internal Fan Box Screws

3. Tighten the two external screws, one at each side of the system, as shown by the figure below.

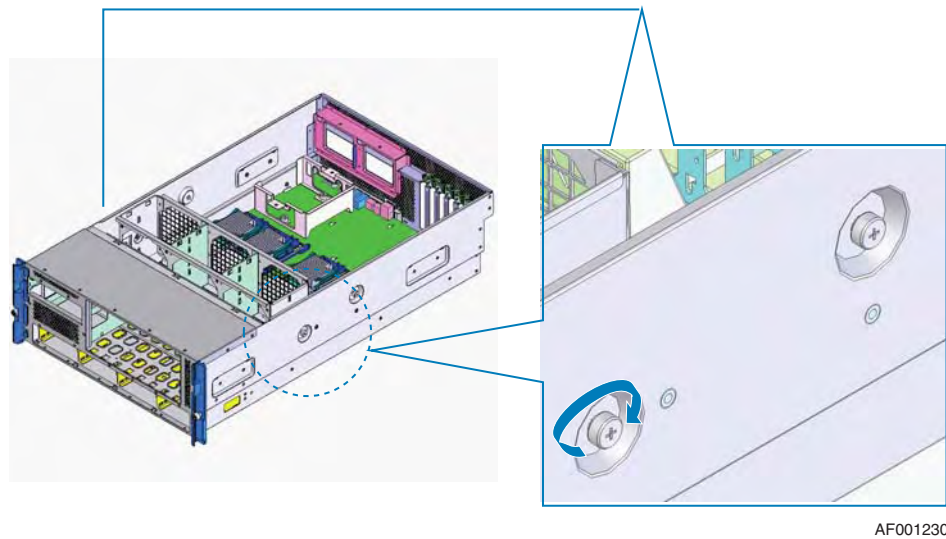

Figure 102. Tighten the External Fan Box Screws

4. Determine your next course of action and refer to the appropriate steps:
 - If you are following these steps as part of another procedure, return to that procedure.
 - If you are ready to re-assemble your server system, install the following items, in order:
 - ✧ All installed fans. For instructions, see [“Installing a Fan” on page 55](#).
 - ✧ The air flow guide. For instructions, see [“Installing the Air Flow Guide” on page 97](#).
 - ✧ The PCI card divider. For instructions, see [“Installing the PCI Card Divider” on page 93](#).
 - ✧ The KVM card, if necessary. For instructions, see [“Installing the KVM Card” on page 90](#).
 - ✧ All installed PCI cards. For instructions, see [“Installing a PCI Card” on page 59](#).
 - ✧ The hard drive backplane cover. For instructions, see [“Installing the Hard Drive Backplane Cover” on page 88](#).
 - ✧ The power supply box. For instructions, see [“Installing the Power Supply Box” on page 80](#).
 - ✧ All installed power supplies. For instructions, see [“Installing a Power Supply” on page 68](#).
 - ✧ The power supply filler panel, if necessary. For instructions, see [“Removing a Power Supply” on page 70](#). Follow step 4 only.
 - ✧ The top cover. For instructions, see [“Installing the Top Cover” on page 37](#).

Installing and Removing the Hard Drive Backplane

Before beginning these steps, power down your server system and unplug all AC power cords.

Removing the Hard Drive Backplane

To perform this procedure, you first need to remove:

- The front bezel. For instructions, see [“Removing the Front Bezel” on page 34](#).
- The top cover. For instructions, see [“Removing the Top Cover” on page 36](#).
- All installed hard drive carriers. For instructions, see [“Removing a Hard Drive” on page 40](#). Follow steps 1 through 3 only.
- The front control panel and optical drive assembly. For instructions, see [“Removing the Front Control Panel and Optical Drive Assembly” on page 74](#).

- All installed power supplies. For instructions, see [“Removing a Power Supply” on page 70](#).
- The power supply filler panel, if one is installed. For instructions, see [“Installing a Power Supply” on page 68](#). Follow step 2 only.
- The power supply box. For instructions, see [“Removing the Power Supply Box” on page 76](#).
- The hard drive backplane cover. For instructions, see [“Removing the Hard Drive Backplane Cover” on page 87](#).
- The KVM card, if it is installed. For instructions, see [“Removing the KVM Card” on page 89](#).
- All installed PCI cards. For instructions, see [“Removing a PCI Card” on page 63](#).
- The PCI card divider. For instructions, see [“Removing the PCI Card Divider” on page 91](#).
- The air flow guide. For instructions, see [“Removing the Air Flow Guide” on page 95](#).
- All installed fans. For instructions, see [“Removing a Fan” on page 57](#).
- The fan box. For instructions, see [“Removing the Fan Box” on page 98](#).

Remove these components, in order, before beginning the steps below.

The steps below do not guide you through reinstalling the components you are removing or disconnecting in this step sequence. These steps assume you are removing the hard drive backplane to either replace it, or to access another component. After completing these steps, continue with the steps that directed you to this section, or follow the steps under [“Installing the Hard Drive Backplane” on page 107](#) to replace your hard drive backplane.

1. Disconnect all cables from the hard drive backplane.
2. Remove the four screws from the hard drive backplane. See the following figure.

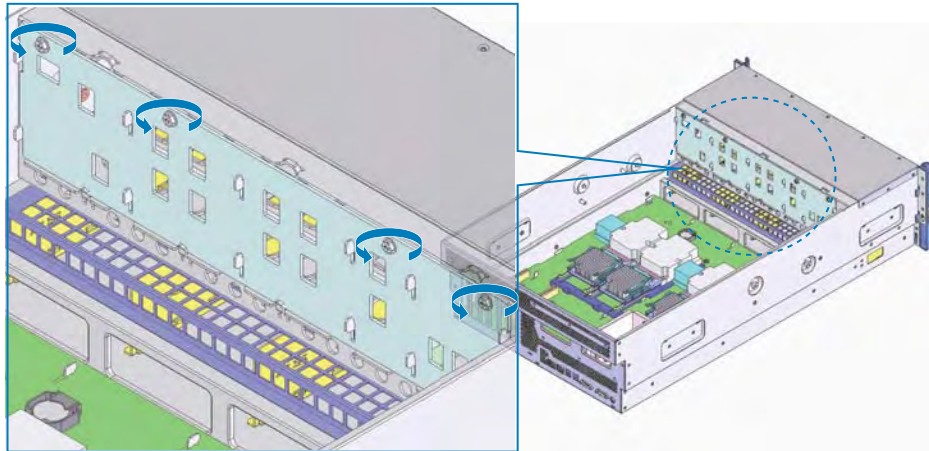

AF001225

Table 18. Loosening the Hard Drive Backplane Screws

3. Pull up slightly on the hard drive backplane to unhook the 12 hooks that hold the backplane into place. See letter “A” in the figure below.
4. Pull the backplane toward the center of the system to disengage the 12 hooks. See letter “B” in the figure.
5. Lift the backplane from the system. See letter “C”.

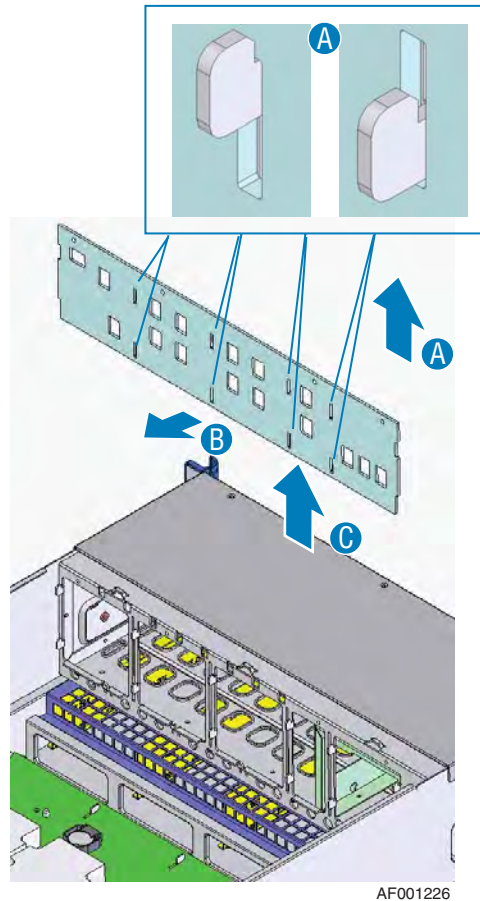

AF001226

Figure 103. Removing the Hard Drive Backplane from System

6. Determine your next course of action and refer to the appropriate steps:
 - If you are following these steps as part of another procedure, return to that procedure.
 - Reinstall the hard drive backplane or install a replacement hard drive backplane. For instructions, see [“Installing the Hard Drive Backplane Cover”](#) on page 88.

Installing the Hard Drive Backplane

These steps assume you have removed the air flow guide, as described in “[Removing the Hard Drive Backplane](#)” on page 103 and your system is partially disassembled.

1. Set the hard drive backplane into place in the system. See letter “A” in the figure below. As you lower the backplane into place, ensure that the 12 hooks in the chassis insert through the eight slots and four notches in the backplane. See letter “B” in the figure.
2. Press down on the backplane to engage the 12 chassis hooks with the backplane. See letter “C” in the figure.

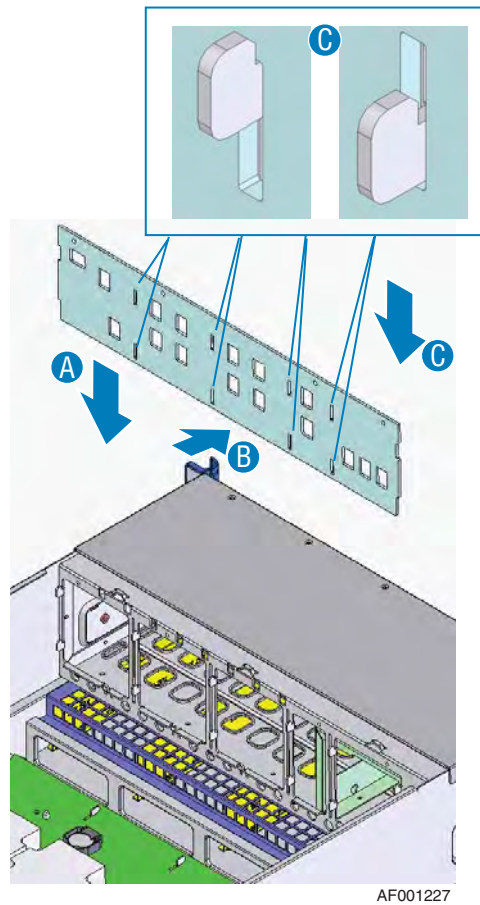
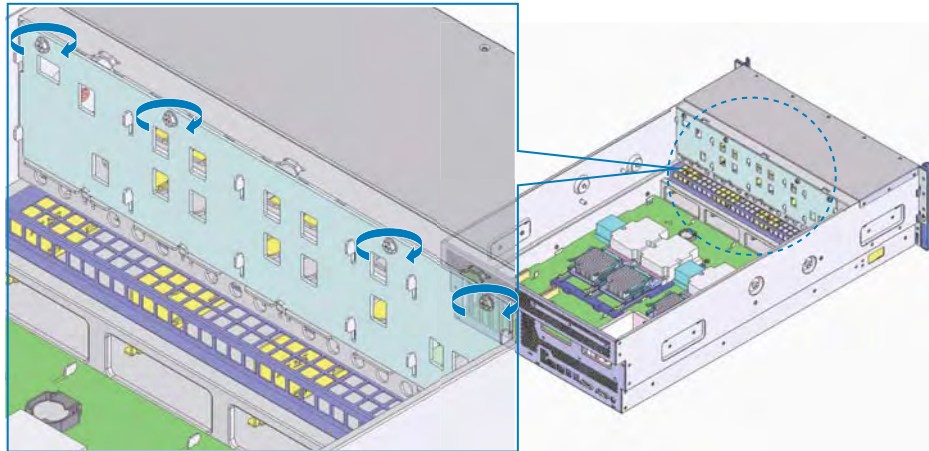

Figure 104. Installing the Hard Drive Backplane

3. Install the four screws on the hard drive backplane to secure the backplane to the system. See the figure below.



AF001228

Figure 105. Attaching the Hard Drive Backplane to the System

4. Connect the cables to the backplane:
 - Connect the SAS cable to J54P0
 - If you have a second SAS cable, connect it to J54P1
 - Connect the IDE cable to JVDD
 - Connect the backplane power cable to JPANELPW
 - Connect the backplane data cable to JPANEL
5. Determine your next course of action and refer to the appropriate steps:
 - If you are following these steps as part of another procedure, return to that procedure.
 - If you are ready to re-assemble your server system, reinstall the following items, in order:
 - ✧ The fan box. For instructions, see [“Installing the Fan Box” on page 101](#).
 - ✧ All installed fans. For instructions, see [“Installing a Fan” on page 55](#).
 - ✧ The air flow guide. For instructions, see [“Installing the Air Flow Guide” on page 97](#).
 - ✧ The PCI card divider. For instructions, see [“Installing the PCI Card Divider” on page 93](#).
 - ✧ The KVM card, if it is installed. For instructions, see [“Installing the KVM Card” on page 90](#).
 - ✧ All installed PCI cards. For instructions, see [“Installing a PCI Card” on page 59](#).

- ✧ The hard drive backplane cover. For instructions, see [“Installing the Hard Drive Backplane Cover” on page 88](#).
- ✧ The power supply box. For instructions, see [“Installing the Power Supply Box” on page 80](#).
- ✧ All installed power supplies. For instructions, see [“Installing a Power Supply” on page 68](#).
- ✧ The power supply filler panel, if one is installed. For instructions, see [“Removing a Power Supply” on page 70](#). Follow step 4 only.
- ✧ The front control panel and optical drive assembly. For instructions, see [“Installing the Front Control Panel and Optical Drive Assembly” on page 75](#).
- ✧ All installed hard drive carriers. For instructions, see [“Installing a Hard Drive” on page 38](#). Follow steps 7 through 9 only, unless you also need to install hard drives into the carriers.
- ✧ The top cover. For instructions, see [“Installing the Top Cover” on page 37](#).
- ✧ The front bezel. For instructions, see [“Installing the Front Bezel” on page 35](#).

Installing and Removing a Processor

Before beginning these steps, power down your server system and unplug all AC power cords.

The following figure shows the components of the processor assembly. Refer to this figure as needed during the installation process to identify the components discussed in this section.

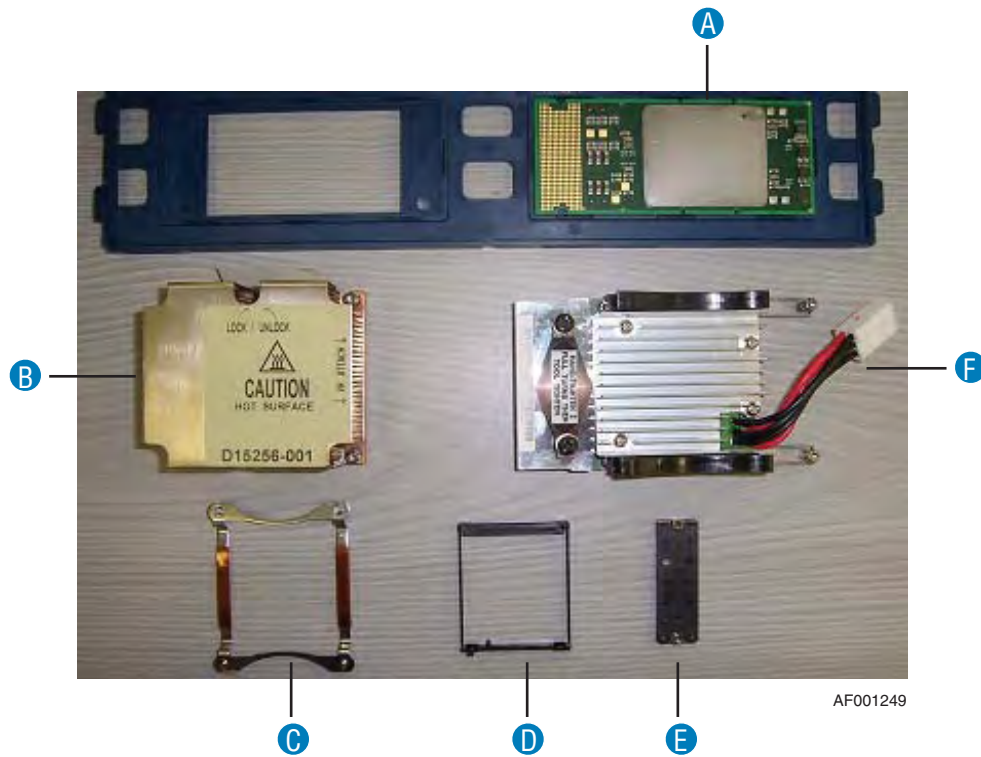

A. Processor	D. Spring shroud
B. Heat sink	E. Bolster plate
C. Spring clip	F. MVR

Figure 106. Processor Assembly Components

Removing a Processor

To perform this procedure, you first need to remove:

- The top cover. For instructions, see [“Removing the Top Cover” on page 36](#).
- All installed power supplies. For instructions, see [“Removing a Power Supply” on page 70](#).
- The power supply filler panel, if one is installed. For instructions, see [“Installing a Power Supply” on page 68](#). Follow step 2 only.
- The power supply box. For instructions, see [“Removing the Power Supply Box” on page 76](#).
- Remove the hard drive backplane cover. For instructions, see [“Removing the Hard Drive Backplane Cover” on page 87](#).
- The KVM card, if it is installed. For instructions, see [“Removing the KVM Card” on page 89](#).
- All installed PCI cards. For instructions, see [“Removing a PCI Card” on page 63](#).
- The PCI card divider. For instructions, see [“Removing the PCI Card Divider” on page 91](#).
- The air flow guide. For instructions, see [“Removing the Air Flow Guide” on page 95](#).

Remove these components, in order, before beginning the steps below.

The steps below do not guide you through reinstalling the components you are removing or disconnecting in this step sequence. These steps assume you are removing the processor to either replace it, or to access another component. After completing these steps, continue with the steps that directed you to this section, or follow the steps under [“Installing the Processor” on page 113](#) to replace your processor.

1. Lift up on the MVR handles to remove them. One handle is on each side of the MVR. See the figure below.

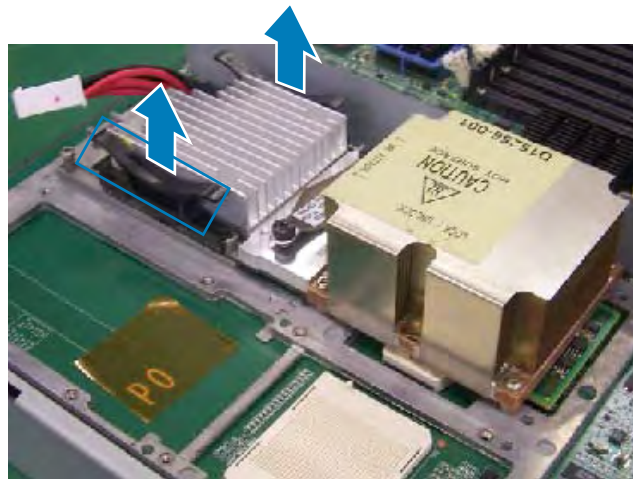

AF001251

Figure 107. Removing the MVR Handles

2. Use a Torx-15 screwdriver to loosen the two captive screws on the LGA terminal that is located between the MVR and the heat sink. See letter “A” in the figure below.
3. Use a Torx-15 screwdriver to loosen the four screws on the corners of the MVR. See letter “B” in the figure.

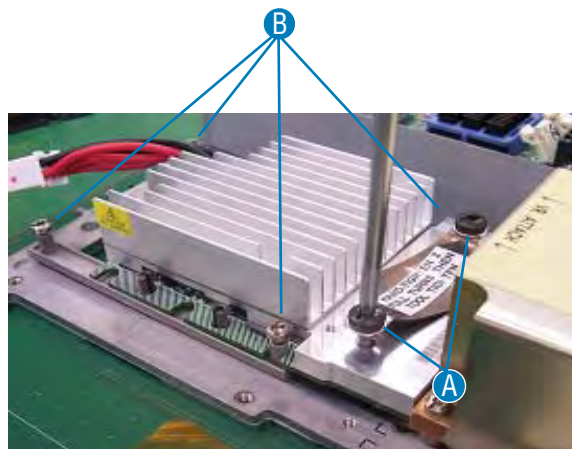

AF001252

Figure 108. Loosening the MVR Screws

4. Lift the MVR straight up from the system to remove it.

5. If necessary, disassemble the processor. For instructions, see [“Disassembling a Processor Assembly” on page 122](#).
6. Determine your next course of action and refer to the appropriate steps:
 - If you are following these steps as part of another procedure, return to that procedure.
 - If you removed the processor to replace it, see [“Installing the Processor” on page 113](#).
 - If you are ready to re-assemble your server system, reinstall the following items, in order:
 - ✧ The air flow guide. For instructions, see [“Installing the Air Flow Guide” on page 97](#).
 - ✧ The PCI card divider. For instructions, see [“Installing the PCI Card Divider” on page 93](#).
 - ✧ The KVM card, if necessary. For instructions, see [“Installing the KVM Card” on page 90](#).
 - ✧ All installed PCI cards. For instructions, see [“Installing a PCI Card” on page 59](#).
 - ✧ The hard drive backplane cover. For instructions, see [“Installing the Hard Drive Backplane Cover” on page 88](#).
 - ✧ The power supply box. For instructions, see [“Installing the Power Supply Box” on page 80](#).
 - ✧ All installed power supplies. For instructions, see [“Installing a Power Supply” on page 68](#).
 - ✧ The power supply filler panel, if necessary. For instructions, see [“Removing a Power Supply” on page 70](#). Follow step 4 only.
 - ✧ The top cover. For instructions, see [“Installing the Top Cover” on page 37](#).

Installing the Processor

To perform this procedure, you first need to remove the following items. If you have just removed a processor, you have already removed these items.

- The top cover. For instructions, see [“Removing the Top Cover” on page 36](#).
- All installed power supplies. For instructions, see [“Removing a Power Supply” on page 70](#).
- The power supply filler panel, if one is installed. For instructions, see [“Installing a Power Supply” on page 68](#). Follow step 2 only.
- The power supply box. For instructions, see [“Removing the Power Supply Box” on page 76](#).
- Remove the hard drive backplane cover. For instructions, see [“Removing the Hard Drive Backplane Cover” on page 87](#).

- The KVM card, if it is installed. For instructions, see “[Removing the KVM Card](#)” on [page 89](#).
- All installed PCI cards. For instructions, see “[Removing a PCI Card](#)” on [page 63](#).
- The PCI card divider. For instructions, see “[Removing the PCI Card Divider](#)” on [page 91](#).
- The air flow guide. For instructions, see “[Removing the Air Flow Guide](#)” on [page 95](#).

Remove these components, in order, before beginning the steps below.

Caution: *Handle the processor only by the edges. Do not touch the pin grid or the LGA terminal.*

1. Remove the protective cover from the underside of the heatsink to expose the thermal interface material. Do not touch the thermal interface material. See the figure below.

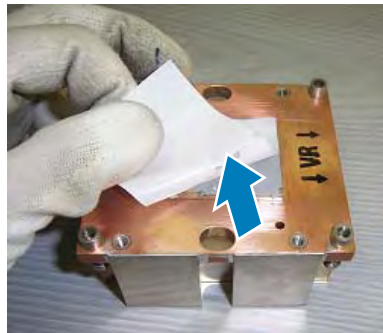

AF001262

Figure 109. Exposing the Thermal Interface Material

2. Verify that there are no bent pins or dust on the processor pins.
3. Position the pin shroud so the arrow points to the LGA terminal.

Cautions:

- *Do not touch the processor pins with either your hands or with the pin shroud.*
- *The pin shroud is fragile. Use caution when installing it. Excessive flex will break the pin shroud.*

4. Snap the pin shroud over the processor, verifying that the positioning pins of the pin shroud align with the notches in the processor.

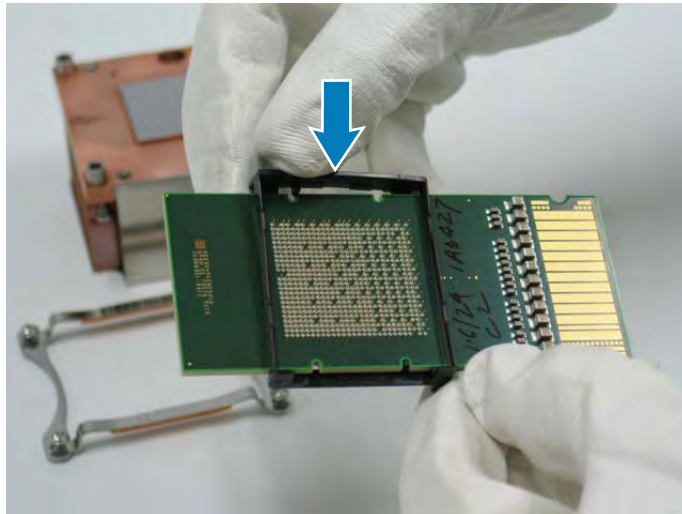

AF001265

Figure 110. Installing the Pin Shroud over the Processor

5. Set the spring clip into place on the processor as shown below. The rounded edge of the spring clip should be positioned below the pin shroud.

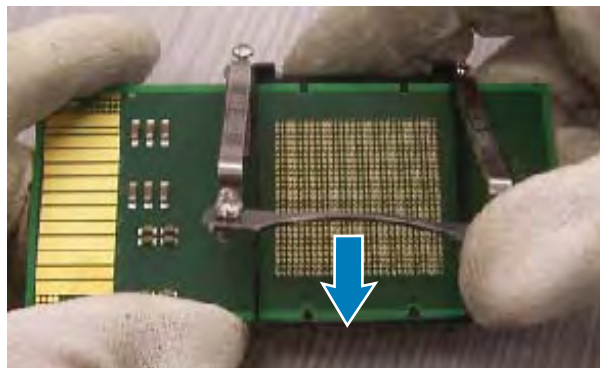

AF001264

Figure 111. Installing the Spring Clip

6. While holding the spring clip in place on the processor, align the positioning pins on processor with the holes in the heat sink.
7. Set the processor in place over the heat sink. See the figure below.

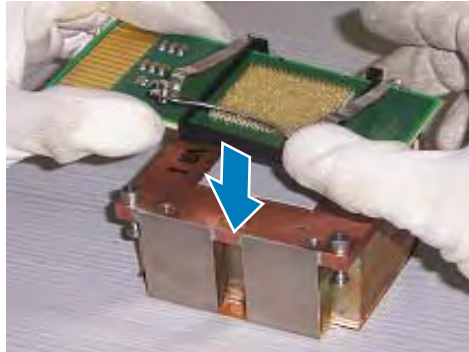

AF001263

Figure 112. Setting the Processor over the Heat Sink

8. Use a Tork-15 screwdriver to tighten the four screws on the spring clip to secure the processor to the heat sink. Use a fastening torque of 0.45[N.m] (4.61[kgf.cm]). See the figure below.

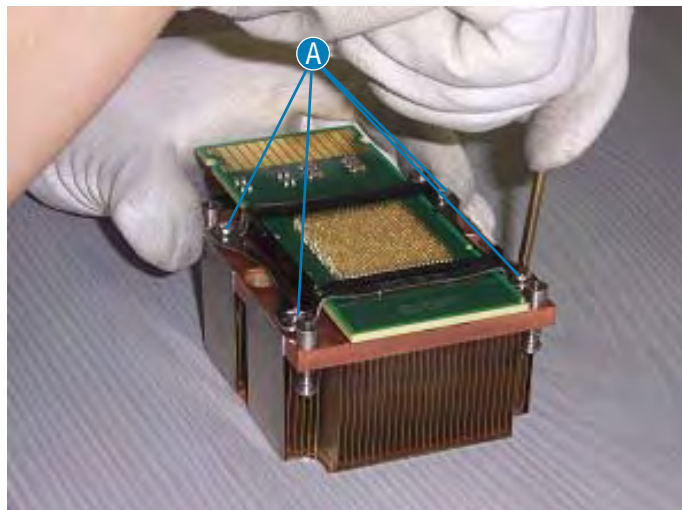

AF001259

Figure 113. Securing the Processor to the Heat Sink

9. Install the bolster plate onto the LGA terminal. See the figure below.

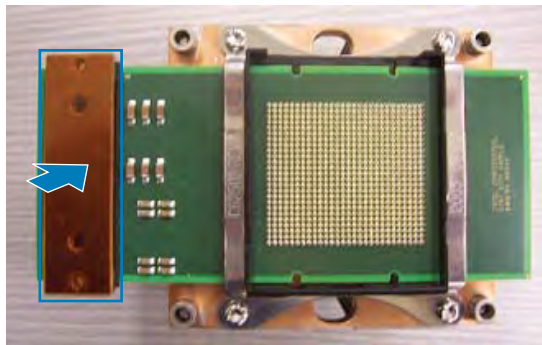

AF001266

Figure 114. Installing the Bolster Plate onto the Processor

10. Make sure the processor lock on the main board is in the unlocked position. See the figure below.

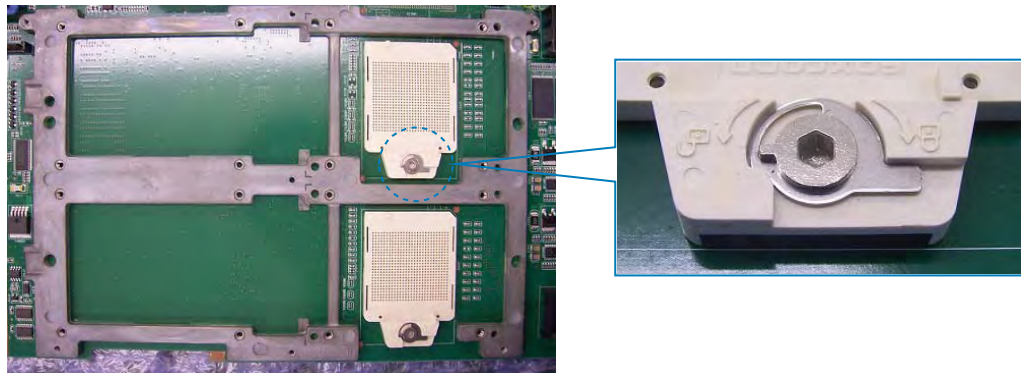

AF001267

Figure 115. Making Sure the Processor Socket is Unlocked

11. Carefully set the processor assembly into place on the main board, aligning the heatsink screws with the corresponding holes in the server board. See the figure below.

Caution: Do not allow the processor pins to rub against the processor socket. If the processor does not seated easily, remove the assembly, inspect pins, socket and heat sink for possible damage, and set the assembly into place again.

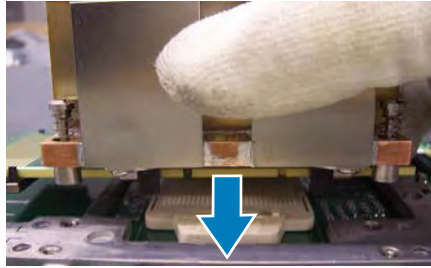

AF001268

Figure 116. Setting the Processor Assembly into Place over the Processor Socket

12. Use a hexagonal wrench to turn the processor lock on the server board to the locked position. See letter “A” in the figure below.
13. Use a Torx-15 screwdriver to tighten the four screws on the corners of the heat sink. Use a torque level of 0.68[N.m] (6.9[kghf.cm]). See letter “B” in the figure.

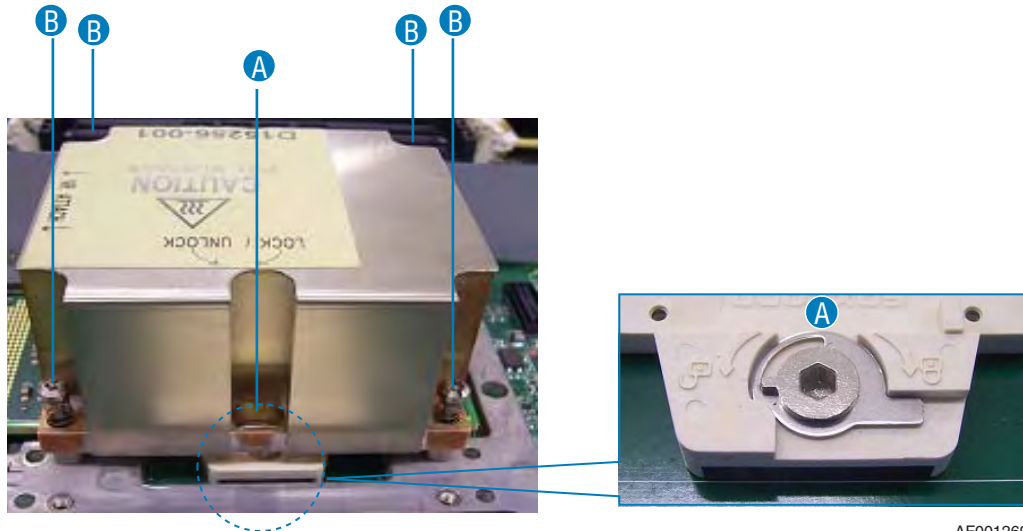

AF001269

Figure 117. Attaching the Processor and Heat Sink to the Main Board

14. Remove the protective cover from the LGA terminal on the back of the MVR. See the figure below.

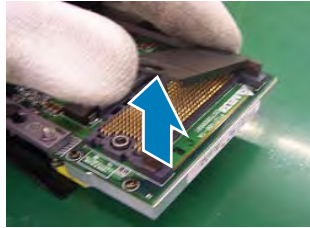

AF001271

Figure 118. Removing the Protective Cover from the LGA Terminal

15. Align the LGA terminal of the MVR with the LGA terminal pad of the processor assembly.

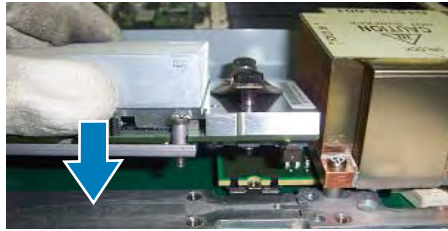

AF001272

Figure 119. Setting the MVR into Place on the Processor Assembly

16. Use a Torx-15 screwdriver to tighten the four screws at the corners of the MVR. Use a torque level of 0.68[N.m] (6.9[kgf.cm]). See letter “B” in the figure below.
17. Use a Torx-15 screwdriver to tighten the two screws on the LGA terminal. See letter “A” in the figure.

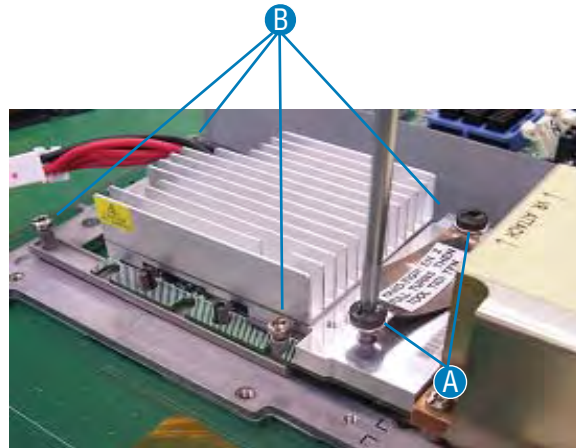

AF001252

Figure 120. Attaching the MVR to the Processor Assembly

18. Press the MVR handles into place on each side of the MVR. See the figure below.

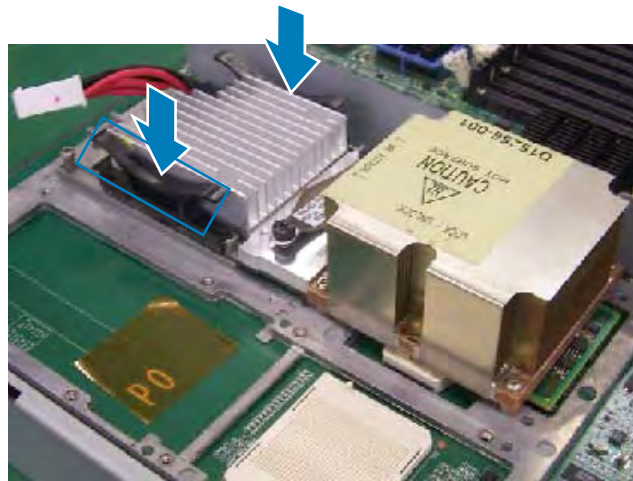

AF001274

Figure 121. Installing the Handles onto the MVR

19. Determine your next course of action and refer to the appropriate steps:
- If you are following these steps as part of another procedure, return to that procedure.
 - If you removed the processor to replace it, see [“Installing the Processor” on page 113](#).
 - If you are ready to re-assemble your server system, reinstall the following items, in order:
 - ✧ The air flow guide. For instructions, see [“Installing the Air Flow Guide” on page 97](#).
 - ✧ The PCI card divider. For instructions, see [“Installing the PCI Card Divider” on page 93](#).
 - ✧ The KVM card, if necessary. For instructions, see [“Installing the KVM Card” on page 90](#).
 - ✧ All installed PCI cards. For instructions, see [“Installing a PCI Card” on page 59](#).
 - ✧ The hard drive backplane cover. For instructions, see [“Installing the Hard Drive Backplane Cover” on page 88](#).
 - ✧ The power supply box. For instructions, see [“Installing the Power Supply Box” on page 80](#).
 - ✧ All installed power supplies. For instructions, see [“Installing a Power Supply” on page 68](#).
 - ✧ The power supply filler panel, if necessary. For instructions, see [“Removing a Power Supply” on page 70](#). Follow step 4 only.
 - ✧ The top cover. For instructions, see [“Installing the Top Cover” on page 37](#).

Disassembling a Processor Assembly

Before beginning this procedure, follow all steps necessary to remove the processor from the server system. For instructions, see “Removing a Processor” on page 111.

1. On the underside of the MVR, install the protective cover over on the LGA terminal.

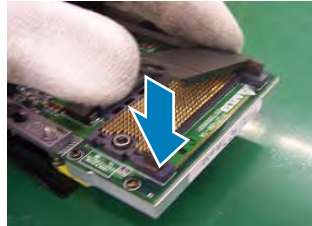

AF001254

Figure 122. Installing the LGA Terminal Cover

2. Use a Torx-15 screwdriver to loosen the four screws on the corners of the heat sink. See letter “A” in the figure below.
3. Use a hexagonal wrench to turn the processor lock counter-clockwise to unlock the processor socket. See letter “B” in the figure.
4. Verify that the processor lock is in the unlocked position. See letter “C”.
5. Lift the processor and heat sink assembly straight up to remove it from the server.

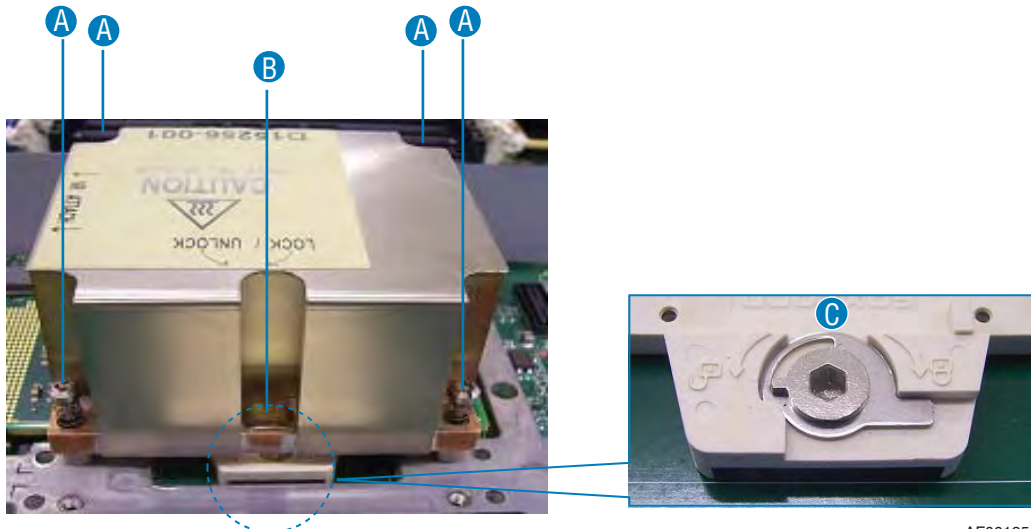

AF001255

Figure 123. Loosening the Heat Sink Screws

6. Lift the bolster plate from the LGA terminal on the underside of the heat sink / processor assembly. See the figure below.

Caution: *The processor can be damaged if handled improperly. Do not touch the processor pins.*

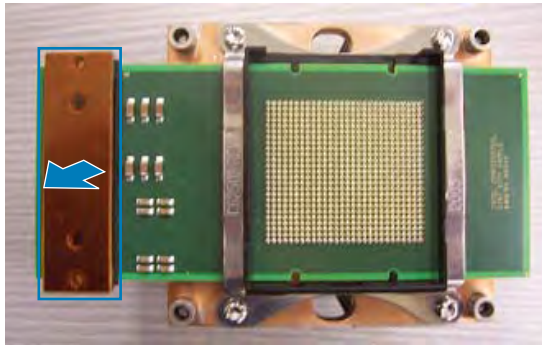

AF001253

Figure 124. Removing the Bolster Plate from the Processor

7. Use a Torx-15 screwdriver to loosen four spring clip screws. See letter “A” in the following figure.

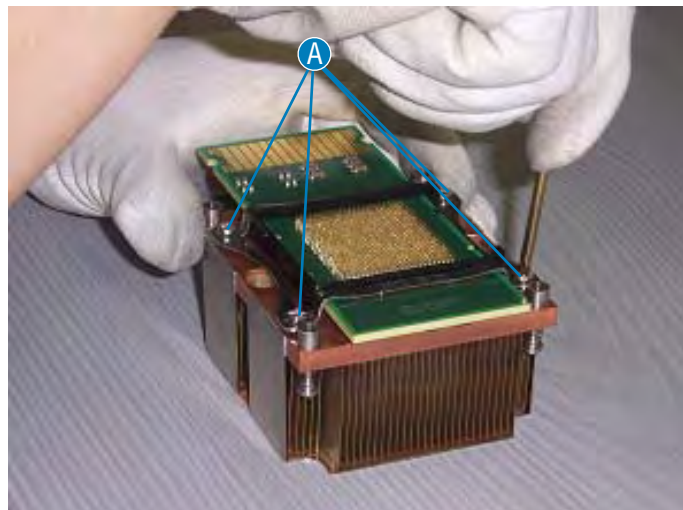

AF001259

Figure 125. Removing the Processor from the Heatsink

- Lift the spring clip from the processor. See the following figure.

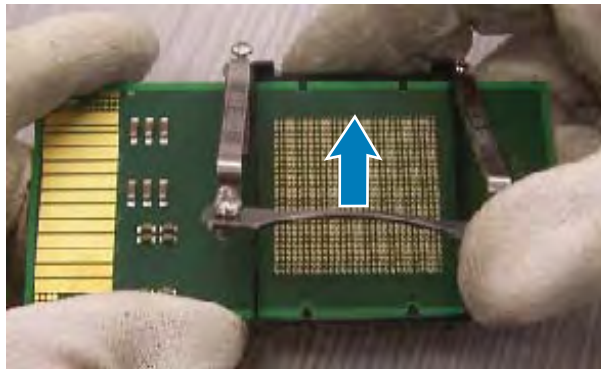

AF001261

Figure 126. Removing the Spring Clip

- Lift the processor from the heat sink.
- Carefully push out on one side of the pin shroud to release it from the processor.

Cautions:

- *Do not touch the processor pins with either your hands or with the pin shroud.*
- *The pin shroud is fragile. Use caution when removing it. Excessive flex will break the pin shroud.*

- Remove the pin shroud.

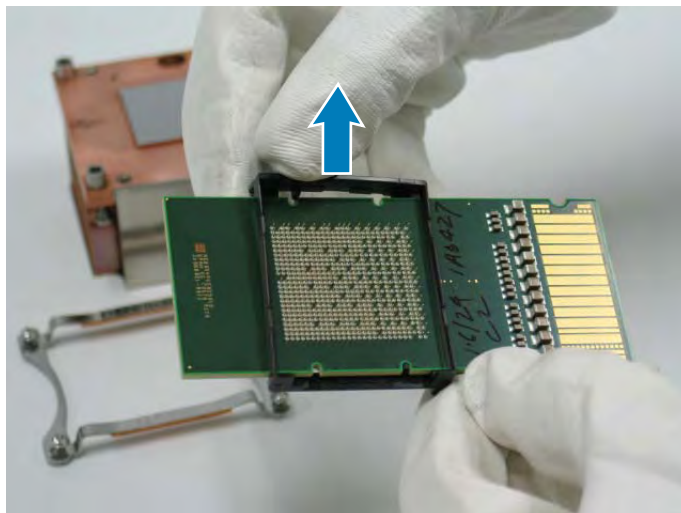

AF001273

Figure 127. Removing the Pin Shroud from the Processor

Installing and Removing the Mounting Plate

Before beginning these steps, power down your server system and unplug all AC power cords.

Removing the Mounting Plate

To perform this procedure, you first need to remove:

- The front bezel. For instructions, see [“Removing the Front Bezel” on page 34](#).
- The top cover. For instructions, see [“Removing the Top Cover” on page 36](#).
- All installed hard drive carriers. For instructions, see [“Removing a Hard Drive” on page 40](#). Follow steps 1 through 3 only.
- The front control panel and optical drive assembly. For instructions, see [“Removing the Front Control Panel and Optical Drive Assembly” on page 74](#).
- All installed power supplies. For instructions, see [“Removing a Power Supply” on page 70](#).
- The power supply filler panel, if one is installed. For instructions, see [“Installing a Power Supply” on page 68](#). Follow step 2 only.
- The power supply box. For instructions, see [“Removing the Power Supply Box” on page 76](#).
- The power supply support. For instructions, see [“Removing the Power Supply Support” on page 83](#).
- The hard drive backplane cover. For instructions, see [“Removing the Hard Drive Backplane Cover” on page 87](#).
- The KVM card, if it is installed. For instructions, see [“Removing the KVM Card” on page 89](#).
- All installed PCI cards. For instructions, see [“Removing a PCI Card” on page 63](#).
- The PCI card divider. For instructions, see [“Removing the PCI Card Divider” on page 91](#).
- The air flow guide. For instructions, see [“Removing the Air Flow Guide” on page 95](#).
- All installed fans. For instructions, see [“Removing a Fan” on page 57](#).
- The fan box. For instructions, see [“Removing the Fan Box” on page 98](#).

Remove these components, in order, before beginning the steps below. In addition, if you are replacing your mounting plate and intend to reinstall your existing processors onto the new mounting plate, you will need to remove the processor assembly. For instructions, see [“Removing a Processor” on page 111](#).

The steps do not guide you through reinstalling the components you are removing or disconnecting in this step sequence. These steps assume you are removing the mounting plate to replace it. After completing these steps, continue with [“Installing the Mounting Plate” on page 127](#) to replace your mounting plate.

1. Grasp the front handle of mounting plate assembly and lift the mounting plate slightly. See letter “A” in the figure below.
2. While continuing to hold the front of the mounting plate, grasp the handle at the rear of the mounting plate. See letter “B” in the figure.
3. Lift the mounting plate from the system.

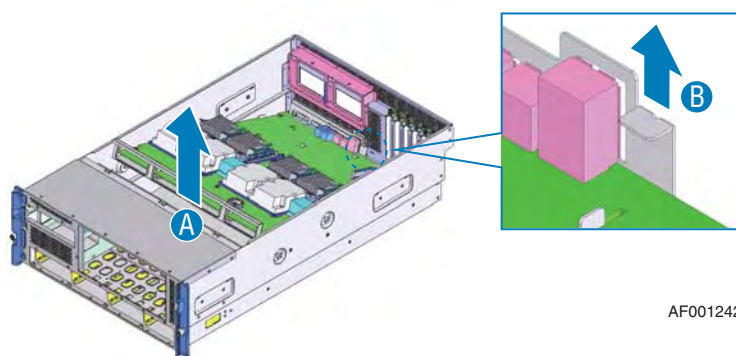

AF001242

Figure 128. Lifting the Mounting Plate from the System

4. Install a replacement mounting plate. For instructions, see [“Installing the Mounting Plate” on page 127](#).

Installing the Mounting Plate

These instructions assume your server system is disassembled and you are replacing a mounting plate.

1. Hold the mounting plate by the front and back handles.
2. Set the back of the mounting plate into place, verifying that the guide pins in the chassis align with the corresponding holes in the mounting plate. See the figure below.
3. Lower the front of the mounting plate into place.

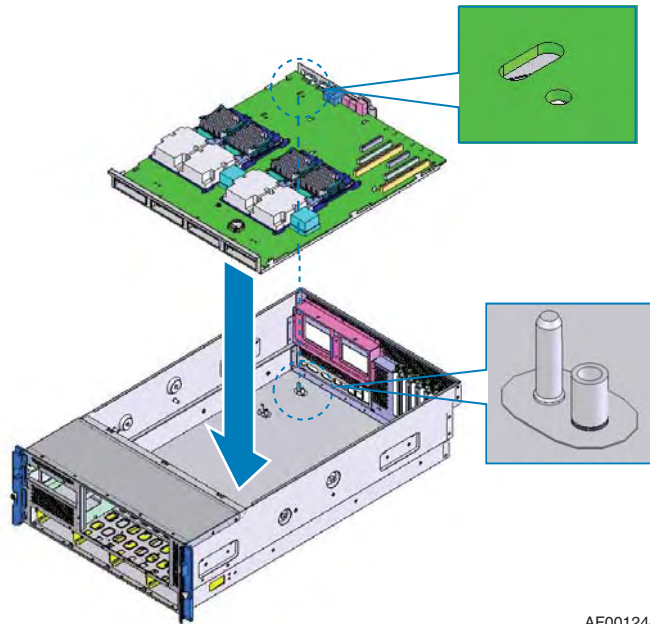

AF001244

Figure 129. Setting the Mounting Plate into Place

4. Connect the cables to the hard drive backplane:
 - Connect the SAS cable to J54P0
 - If you have a second SAS cable, connect it to J54P1
 - Connect the IDE cable to JVDD
 - Connect the backplane power cable to JPANELPW
 - Connect the backplane data cable to JPANEL
5. Install the following items, in order:
 - The fan box. For instructions, see [“Installing the Fan Box”](#) on page 101.
 - All installed fans. For instructions, see [“Installing a Fan”](#) on page 55.
 - The air flow guide. For instructions, see [“Installing the Air Flow Guide”](#) on page 97.

- The PCI card divider. For instructions, see [“Installing the PCI Card Divider” on page 93](#).
- The KVM card, if necessary. For instructions, see [“Installing the KVM Card” on page 90](#).
- All installed PCI cards. For instructions, see [“Installing a PCI Card” on page 59](#).
- The hard drive backplane cover. For instructions, see [“Installing the Hard Drive Backplane Cover” on page 88](#).
- The power supply support. For instructions, see [“Installing the Power Supply Support” on page 85](#).
- The power supply box. For instructions, see [“Installing the Power Supply Box” on page 80](#).
- All installed power supplies. For instructions, see [“Installing a Power Supply” on page 68](#).
- The power supply filler panel, if necessary. For instructions, see [“Removing a Power Supply” on page 70](#). Follow step 4 only.
- The front control panel and optical drive assembly. For instructions, see [“Installing the Front Control Panel and Optical Drive Assembly” on page 75](#).
- All installed hard drive carriers. For instructions, see [“Installing a Hard Drive” on page 38](#). Follow steps 7 through 9 only, unless you also need to install hard drives into the carriers.
- The top cover. For instructions, see [“Installing the Top Cover” on page 37](#).
- The front bezel. For instructions, see [“Installing the Front Bezel” on page 35](#).

Installing and Removing Chassis Handles

Installing Chassis Handles

Two handles can be installed on each side of the server chassis to aide in lifting and carrying the server system. Use the following instructions to install each handle.

1. Set the handle into place in the sheetmetal indentation designed for the handle. See letter “A” in the figure below.
2. Set the fixing plate into place over the handle. See letter “B” in the figure.
3. Use two screws to attach the handle and fixing plate to the chassis. See letter “C” in the figure.
4. Repeat steps 1 - 3 for each handle.

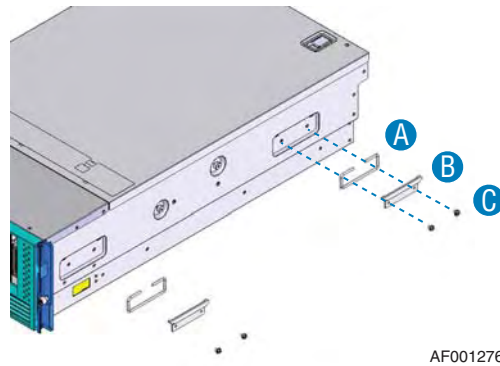

Figure 130. Attaching the Chassis Handles

Removing Chassis Handles

1. Loosen two screws that hold each handle assembly in place.
2. Lift the handle assembly from the chassis.
3. Repeat steps 1 - 2 for each handle.

4 Configuration Software and Utilities

The Extensible Firmware Interface (EFI) Boot Manager

The EFI boot manager enables the user to control the booting environment of server. After power is on, the boot manager activates the system with various ways according to the boot option settings. For example, the user can boot the EFI shell, an operating system on the network or on media in the server, or the boot maintenance menu.

- **EFI Shell:** A simple and interactive environment that can load the EFI device drivers, start the EFI applications, and boot the operating systems. The EFI shell also provides a series of commands that are used to manage files and system environment variables. For details of the EFI shell, see [“The Extensible Firmware Interface \(EFI\) Shell” on page 134](#)
- **Boot Options:** Files that the user included as boot options. By using the Boot Maintenance Menu, the user can add and delete boot options. Each boot option specifies an EFI executable with available options. See [Table 19 on page 132](#) for information about the Boot Maintenance Menu options.
- **Boot Maintenance:** A menu of items that enables the user to set boot options and other boot environment variables. [Table 19 on page 132](#) describes each menu item in the Boot Maintenance Menu.

Table 19. Boot Maintenance Menu Options

Option	Description
Boot from a File	<p>Automatically adds EFI applications or allows the user to boot from a specific file.</p> <p>When the user selects this option, the system searches for the EFI directory in all EFI System Partitions in the system. For each EFI directory, the system searches the subdirectories. Within each subdirectory, the system searches for the first file that is an executable EFI Application.</p> <p>Each file that meets this criterion is added as a boot option automatically. Legacy boot options such as A: and C: are added if these devices exist.</p> <p>Using this option enables the user to start a specific application without adding it as a boot option. In this case, the EFI Boot Manager searches the EFI application in the root directories of all of the EFI System Partitions that exist in the system.</p> <p>To boot from a file:</p> <ol style="list-style-type: none"> 1. Use the arrow keys to select [Boot from a File Option]. 2. Press the <Enter> key. 3. Use the arrow keys to select the EFI file to boot with. 4. Press the <Enter> key.
Add a Boot Option	<p>Adds a boot option to the EFI Boot Manager.</p> <p>The user specifies the option by providing the EFI application name. The user can also provide, along with the name, either ASCII or UNICODE arguments that are required.</p> <p>When the EFI application name and any options are given, the EFI Boot Manager searches for the executable file in the same partitions and directories as described in [Boot from a File] option. When the file is found, it is executed.</p> <p>To add a boot option:</p> <ol style="list-style-type: none"> 1. Use the arrow keys to select [Add Boot Option]. 2. Press the <Enter> key. 3. Type the name of the EFI application to add 4. Press the <Enter> key. 5. Select [Save to NVRAM]. 6. Select [Exit] to return to the Boot Manager.

Table 19. Boot Maintenance Menu Options

Option	Description
Delete Boot Options	<p>Deletes a specific boot option or all boot options.</p> <p>To delete boot options:</p> <ol style="list-style-type: none">1. Use the arrow keys to select [Delete Boot Option]2. Press the <Enter> key.3. Use the arrow keys to select the boot option to delete4. Press the <Enter> key.5. Press the <Y> key to confirm.6. Select [Save to NVRAM].7. Select [Exit] to return to the Boot Manager.
Change Boot Order	<p>Controls the relative order in which the EFI Boot Manager attempts boot. See the help menu for help on the control key sequences required for this option.</p> <p>To change the boot order:</p> <ol style="list-style-type: none">1. Use the arrow keys to select [Change Boot Order].2. Press the <Enter> key.3. Use the arrow keys to select the Option to move.4. Press the <u> key to move the selection up in the boot order. Press the <d> key to move the selection down in the boot order.5. Select [Save to NVRAM].6. Select [Exit] to return to the Boot Manager.
Manage BootNext Setting	<p>Selects a boot option to use at the next boot operation.</p> <p>To manage the boot at the next setting:</p> <ol style="list-style-type: none">1. Use the arrow keys to select [Manage Boot Next Setting].2. Press the <Enter> key.3. Use the arrow keys to select the Option to boot next time.3. Press the key to start this option at the next time. Press the <r> key to reset.4. Select [Save to NVRAM].5. Select [Exit] to return to the Boot Manager.

Table 19. Boot Maintenance Menu Options

Option	Description
Set Auto Boot Timeout	Configures the value in seconds for the system automatically boots without user intervention. Setting '0' disables the timeout function. To set auto boot timeout: 1. Use the arrow keys to select [Set Auto Boot Timeout] 2. Press the <Enter> key. The following three options are available. <ul style="list-style-type: none">• Use the arrow keys to select [Choose Value option]. Enter '0' to disable auto boot.• Use the arrow keys to select [Delete]. Use the arrow keys to select Delete. Press the <Enter> key.• Select 65535 (0xFFFF) for a time out value to disable timeout by pressing any key while booting EFI.
Select Active Console Output Device	Selects the device to which the console output is sent.
Select Active Console Input Device	Selects the device from which the console receives input.
Select Active Standard Error Device	Selects the standard error device.
System Setup	Starts system setup utility.
Exit	Returns control to the main menu of EFI Boot Manager. Selecting this option displays the active boot devices.

The Extensible Firmware Interface (EFI) Shell

The EFI Shell is an EFI application that enables other EFI applications to start, EFI device drivers to load, and operating systems to boot. The combination of the EFI firmware and the EFI shell provides the system environment that can be changed easily to adapt to various hardware configurations.

The EFI shell also provides a series of basic commands to manage files, EFI NVRAM shell, and boot variables. The details of EFI shell utility is provided by typing “help” and press the <Enter> key during EFI shell operation.

In addition to basic shell commands in EFI shell, the user can create original commands and EFI applications in EFI environment.

EFI shell commands are listed below.

Table 20. EFI Shell Commands

Command	Description
alias [-d -v -b][AliasName][value]	Displays, creates, or deletes alias on EFI shell.
attrib [+/-ashr][-b][file...][directory...]	Displays or modifies attribute for file and directory.
bcfg driver boot [dump [-v]] [add # file "desc"] [rm #] [mv # #]	Displays or modifies settings of driver/boot.
cd [path]	Changes current directory.
cls [background color]	Clears the screen.
comp file1 file2	Compares the contents of two files.
connect [-r][[-c] Handle# DeviceHandle# DriverHandle#]	Connects the EFI driver to a device, and starts the driver.
cp [-r][-q] src [src...] [dst]	Copies files and directories.
date [mm/dd/[yy]yy]	Displays or sets the system date.
dblk device [Lba] [blocks]	Performs a hex dump of block device.
devices [-b] [-IXXX]	Displays a list of devices managed by the EFI driver.
devtree [-b] [-d] [-IXXX] [DeviceHandle]	Displays device tree that follows the EFI driver model.
dh [-b] [-d] [-IXXX] [-v] [handle][[-p prot_id]	Displays handle information under the EFI environment.
disconnect DeviceHandle# [DriverHandle# [ChildHandle#]] [-r]	Disconnects device from driver.
dmem [Address] [Size] [:MMIO]	Displays memory configuration.
dmpstore	Dumps or displays NVRAM variables.
drivers [-b] [-IXXX]	Displays driver that follows the EFI driver model.
drvcfg [-c] [-IXXX] [-f] [-v] [-s] [DriverHandle [DeviceHandle [ChildHandle]]]	Invokes the driver configuration protocol.
drvdiag [-c] [-IXXX] [-s] [-e] [-m] [DriverHandle [DeviceHandle [ChildHandle]]]	Invokes the driver diagnostics protocol.
echo [-on -off] [message]	Executes standard output of messages or switches on/off of command echoing.
edit [file]	Edits ASCII or UNICODE file.
err [Error Level]	Displays or modifies error level.
exit	Exits the EFI shell.
for	Repeats a series of commands according to the condition.
goto label	Creates batch file that jumps to another label.
guid [-b]	Displays all GUIDs under the EFI environment.

Table 20. EFI Shell Commands

Command	Description
help [-b][[cmd]]	Displays command help information.
hexedit [[-f]FileName][-d DiskName Offset Size][[-m Offset Size]]	Edits files in hex mode.
if [not] condition then	Executes commands under specific condition.
load [-nc] file [file...]	Loads the EFI driver.
loadbmp [-c] [-t] [-i[UGA Instance]] file	Displays a bitmap on the screen.
ls [-b] [-r] [-a[attrib]] [file]	Displays files and subdirectories in the directory.
map [-r -v -d] [sname] [handle] [-b]	Displays and configures mapping.
memmap [-b]	Displays a memory map.
mkdir dir [dir...]	Creates new directory.
mm Address [Width 1 2 4 8] [;MMIO ;MEM ;IO ;PCI] [:Value] [-n]	Displays or modifies memory, memory mapped I/O, and PCI.
mode [row col]	Changes current graphic mode.
mount BlkDevice [sname]	Mounts a file system on a block device.
mv src [src...] [dst]	Moves file or directory.
openinfo Handle	Displays handle or agent protocol.
pause	Suspends input from a keyboard.
pci [Bus Dev [Func] [-i] [-s [Seg]]]	Displays information of PCI device and PCI function on config space.
reconnect DeviceHandle# [DriverHandle# [ChildHandle#]] [-r]	Reconnects the driver to a device.
reset [-w [string]]	Resets the system.
rm [-q] file [file...] dir [dir...]	Deletes file or directory.
set [-d -v -b] [sname [value]]	Displays, creates, modifies, or deletes the EFI environment variables.
stall microseconds	Delays the processor by the specified micro seconds.
time [hh:mm[:ss]]	Displays or sets the time of the system.
type [-a -u] [-b] file [file...]	Displays the contents of a file.
ver	Displays version information.
vol [fs] [Volume Label]	Displays volume information of a file.

LSI* SAS Utility

See also “Integrated RAID User's Guide” at <http://www.lsilogic.com>.

Formatting a Hard Drive

Use the LSA SAS utility to format your hard drive. Use the following instructions.

Note: Because there is a time lag between screen changes, use caution in pressing the [Enter] key. Do not press the [Enter] key several times in succession. Between key presses wait for the screen to fully load before proceeding.

1. Boot to the EFI shell, and then start the SAS utility.
2. The adapter list is displayed. Select the adapter that is connected to the hard drive you need to format. Press the <Enter> key.

```
LSI Logic MPT Setup Utility  2.00.06.00
Adapter List
Adapter          PCI      PCI      PCI FW Revision  Status
                  Bus      Dev      Fnc
SAS1068         09      01      00 0.07.07.00-IT  Enabled

Esc = Exit Menu      F1/Shift+1 = Help
Enter = Adapter Properties
```

3. When adapter properties are shown, select **SAS Topology** and press the <Enter> key.

```
LSI Logic MPT Setup Utility  2.00.06.00
Adapter Properties -- SAS1068

Adapter          SAS1068
PCI Address (Bus/Dev/Func)  09:01:00
MPT Firmware Revision      0.07.07.00-IT
SAS Address              500605B0:00016CA0
Status                   Enabled
Boot Support              [Enabled BIOS & OS]
SAS Topology

Advanced Adapter Properties

Esc = Exit Menu      F1/Shift+1 = Help
Enter = Select Item  -/+ = Change Item
```

4. The SAS Topology is displayed. Select **Direct Attach Devices** and press the <Enter> key.

```
LSI Logic MPT Setup Utility  2.00.06.00
SAS Topology -- SAS1068
                                Device Identifier      Device
SAS1068(09:01:00)              Info
Controller                      Direct Attach Devices  Expander

Esc=Exit  F1=Help  M=More Keys
D=Device Properties
```

5. Select the hard drive and press the <D> key.

```
LSI Logic MPT Setup Utility  2.00.06.00
SAS Topology -- SAS1068
                                Device Identifier      Device
SAS1068(09:01:00)              Info
  Controller                    Direct Attach Devices  Expander
    Phy 0                       FUJITSU MAX3036RC  2101  SAS

Esc=Exit F1=Help M=More Keys
D=Device Properties
```

- When the device properties are displayed, select **Format** and press the <Enter> key.

```
LSI Logic MPT Setup Utility  2.00.06.00
Device Properties -- SAS1068

Device Identifier           FUJITSU MAX3036RC   2101
Scan Order                 46
Bay Number                 0
Device Information        SAS
SAS Address                500000E0:116D3092
Serial Number              DQL0P5A000VH

Format

Verify

Esc=Exit  F1=Help  M=More Keys
N = Next Device  P = Previous Device  Enter = Select Item
```

- When the following screen appears, press the <F> key to begin the format. Formatting a 36 GB hard drive takes about 15 minutes.

```
LSI Logic MPT Setup Utility  2.00.06.00
Device Format -- SAS1068

Device Identifier           FUJITSU MAX3036RC   2101
SAS Address                500000E0:116D3092
Serial Number              DQL0P5A000VH

WARNING!  Format will change the sector size to 512 bytes.
Format will permanently erase all data on this device!
Format may take hours to complete and cannot be stopped.
Press the 'F' key to begin format or any other key to exit.

Elapsed Time:      00:00:00

Percent
Complete          0%                               100%
                  /-----\
                  |
                  \-----/

Esc=Exit  F1=Help  M=More Keys
```

8. After the format has completed, press the <Esc> key several times, until you see the following screen.

```
LSI Logic MPT Setup Utility  2.00.06.00

Are you sure you want to exit?
Cancel Exit
Save changes and restart.
Discard changes and restart.
Exit the Configuration Utility and Restart

Esc = Exit Menu   F1/Shift+1 = Help
```

9. Select **Exit the Configuration Utility and Restart** and press the <Enter> key to exit from the utility.

Clearing the CMOS

To clear the CMOS, use the following steps:

1. Turn off the system.
2. Leave the power cord(s) connected.
3. Hold down the reset button until the system LED begins to flash.
4. Power on the system.

Upgrading the Firmware

The FWUPDATE utility updates the SAL/BMC and writes sensor data records to the Intel® Server System SR9000MK4U. A FWUPDATE is performed as an EFI shell command.

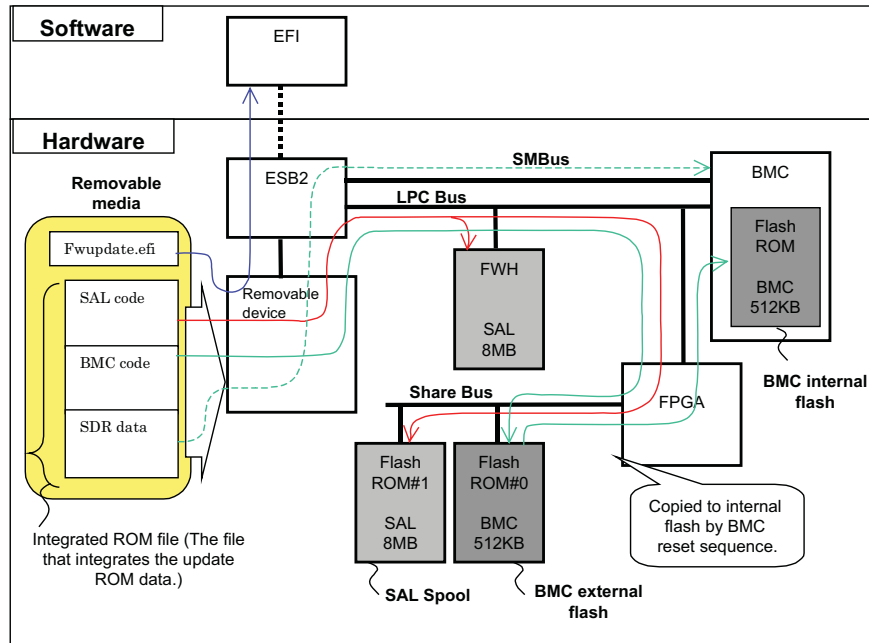

AF001197

Figure 131. Firmware Update Block Diagram

Fwupdate provides the following functions.

- SAL/BMC update
This function updates the SAL (FWH/SAL Spool) and the BMC (external flash) to SAL/BMC in the integrated ROM file specified by file name.
When the “target machine type” and “model” existing in the integrated ROM file is unmatched to the system, the update is not performed.
SAL Spool is used as a back up of SAL. When SAL in FWH is damaged, the SAL is recovered from SAL Spool by using the SAL firmware recovery function.
- Takeover of NVM area
NVM area in FWH stores the EFI parameters such as EFI boot option. By copying the contents of NVM area to take over, resetting of EFI parameters can be omitted.
When version of NVM area managed by SAL is unmatched between FWH SAL and integrated ROM SAL, the takeover is not performed.
- SDR write function
Writes SDR data in the integrated ROM file.

A manual system reset is required as part of the FWUPDATE process.

How to Use FWUPDATE

Fwupdate is executed by entering the following command by EFI shell:

```
fwupdate [File name] [Option] [Enter]
```

The relative file path is as follows. the path is relative path to the current drive.

```
[drive:][directory][file]
```

```
fwupdate IA64_640.ROM; Use ROM image data IA64_640.ROM in current
directory.
fwupdate work\IA64_640.ROM; Use ROM image data IA64_640.ROM in work
directory under current dir.
fwupdate fs0:\IA64_640.ROM; Use ROM image data IA64_640.ROM in fs0
root directory.
fwupdate fs0:\work\IA64_640.ROM; Use ROM image data IA64_640.ROM in
fs0:work directory.
fwupdate fs0:IA64_640.ROM; (not recommend) Command works if fs0 is
the current drive
```

Figure 132. FWUPDATE File Path Example

Table 21. Command Line Description

Option	Function
File name	Integrated ROM file name. The format is as follows: fw_aa-bb_cc-dd.rom aa-bb: SAL version cc-dd: BMC version The file name must be entered unless the /V or /H option is specified.
/f or /F	Does not confirm the write operation. Normally, Down grade confirms the continuation of execution.
/v or /V	Displays the version of SAL (FWH)/BMC (internal flash).
/h or /H or /?	Displays the description of option command.
/l or /L	Updates only SAL in FWH and SAL Spool.
/b or /B	Updates only BMC in external flash.
/n or /N	Does not take over NVM area. (Invalid when /B or /S is specified.)

Execution Screen

```
fs0:>fwupdate fw_01-02_01-03.rom[Enter]

Firmware Update Utility Ver 1.0
Copyright (C) 1996-2000 Intel Corporation. All rights reserved.
*****
Copyright (c) Hitachi, Ltd, 2000-2005. All rights reserved.
*****
Build Date: Tue Feb 27 16:22:51 2005

*Fwupdate is providing update services*

File: fs0:\fw_01-02_01-03.rom Size: 9,371,904 Bytes
Reading file fs0:\fw_01-02_01-03.rom 100% Done!
Sumcheck SAL Data Done!
Sumcheck BMC Data Done!

***** Firmware Version Display *****
      Current - New
BMC      01-02    01-03
SAL      01-01    01-02

Fwupdate is ready to update FLASH devices.

***** SAL update process start *****
*** SAL Spool update process start ***
Chip Erasing FLASH Devices Please wait several minutes!
Chip Erasing FLASH Devices process Done!
Programming FLASH Devices 100% Done!
Verifying FLASH 100% Done!

*** SAL FWH Bank0 update process start ***
Erasing FLASH Devices 100% Done!
Programming FLASH Devices 100% Done
Verifying FLASH 100% Done!

*** SAL FWH Bank1 update process start ***
Erasing FLASH Devices 100% Done!
Programming FLASH Devices 100% Done!
Verifying FLASH 100% Done!

***** BMC update process start *****
Erasing FLASH Devices 100% Done!
Programming FLASH Devices 100% Done!
Verifying FLASH 100% Done!

***** SDR update process start *****
Clear SDR Repository Done!
Add SDR 100% Done!

***** Firmware Version Display *****
      Now
BMC      01-03
SAL      01-02

Firmware update process was completed.
Restart this system at once.
```

Figure 133. FWUPDATE Execution Screen

Using System Setup

This section describes the System Setup. This utility provides a way for the user to to modify the default server settings. Users can execute this utility regardless of whether an operating system has been installed.

Setup stores most of the setting values in the battery-backed CMOS. The rest of the values are stored in flash memory. These values have effects when the user boots the server.

Power-On Self Test (POST) uses these values when sets up the hardware. If the values and the hardware are unmatched, POST generates an error message. In that case, the user must execute setup and specify the correct settings.

In order to view or modify the following server board functions, execute setup.

- Processor configuration
- Memory configuration
- SATA controller setting (Not supported in 4S-4U model.)
- Onboard VGA setting
- Serial port configuration
- Default CMOS settings

Starting Setup

To start setup during the power-on sequence, take the following steps:

1. Press the power button on the front control panel of the server. See Figure 1-3 for the location of the power button.
2. When the EFI Boot Manager is started up, select [Boot Maintenance Menu] and press the <Enter> key.
3. Select [System Setup] in the [Boot Maintenance Menu] and press the <Enter> key. The main screen of system setup appears. For the details of the setup screens, see “Primary Screens” on page 146.

Recording Your Setup Settings

Before modifying any settings, be sure that the current values are recorded. When the restore of default values are required after CMOS clear, for example, the user must execute the setup again. By referring to the stored original settings, the restore operation may become easier.

Navigating Setup Utility Screens

The system setup utility consists of ten primary menus. Each menu occupies one screen and displays a list of menu items. Some menu items have sub-menus. The user can modify the settings of some menu items on the screen. Table 22 describes how to navigate the utility screens and menus.

Table 22. Using Setup Screens

Press	To
Enter key	Selects a sub-menu item or changes to next value of a selected item.
up arrow	Moves up through menu items.
down arrow	Moves down through menu items.

Primary Screens

The Configuration Utility uses the primary screens shown in Table 23.

Table 23. Primary Setup Screens

Screen	Description
Main	No configuration settings available.
Processor	Configures processor. For details of this screen, see “Processor” on page 148 .
Memory	Configures memory. For details of this screen, see “Memory Screen” on page 148 .
Devices	Configures SATA (Not supported in 4S-4U model.) and VGA. For details of this screen, see “Devices Screen” on page 149 .
Server Management	Configures Server Management. For details of this screen, see “Server Management Screen” on page 150 .
System Information	Display firmware version, and board, chassis, product information
Save changes and Exit	Stores the changed values in CMOS, and exits setup. Clicking on the menu item causes the system to prompt the user for a Yes or No response. Yes: Saves the changes and reboots the system. No: Aborts the action.

Table 23. Primary Setup Screens

Screen	Description
Discard changes and Exit	Does not store the changed values in CMOS, and exits setup. Clicking on the menu item causes the system to prompt the user for a Yes or No response. Yes: Saves the changes and exits the utility. No: Aborts the action.
Restore Defaults	Restores the setting values to default. Clicking on the menu item causes the system to prompt the user for a Yes or No response. Yes: Loads the system setup defaults. No: Aborts the action.
Exit	Exits setup. If there are any changes, the user is prompted for a Yes or No response. Yes: Saves the changes and reboots the system. No: Aborts the action.

Table 24. Main Setup Screen

Primary Menu Item	Sub Menu Item	Option	Description
Power On Option	After Power Failure	[Return] On Off	Determines whether the system should boot once power returns after a power loss. Return: Return to previous state at power loss occurs. If power loss occurs at system on state, the system returns to the power-on state at power recovery. If it occurs at system off state, the system will be remaining off state. On: Power on after power recovery. Off: Not goes to power on state (Power off) after power recovery.

When the power button is pressed and released while the main power is on, the power turns off or the operating system begins a shut down process. If the power button is held down, a forced power off is executed. If the power is forced off, then the server is not powered on after AC power recovery even if on is selected as the Power On option. Use the power button to power on the system, and then press and release the power button to shut down the server without forcing it into the power off state.

When the system is configured with AfterPowerFailure = On, the power turns on automatically in the following situations:

- When a power loss occurs while the equipment main power is on.
- When the operating system is shut down normally, the main power turns off, and then a power loss occurs.

Processor

Table 25 describes the menu items available on the Processor screen. Default values appear in brackets.

Table 25. Processor Screen

Menu Item	Options	Description
Hyper Threading	[Disable] Enable	Enables / disables multi threading.
Failed Processor Deconfiguration	[Enable] Disable	Enable: Deconfigures the failure-detected processor and boots. Disable: Cancels boot and turns off the power.

Memory Screen

Table 26 describes the menu items available on the Memory screen. Default values appear in brackets.

Table 26. Memory Screen

Menu Item	Options	Description
Memory Mirroring	[Disable] Enable	Enables / disables memory mirroring.
Failed Memory Deconfiguration	[Enable] Disable	Enable: Deconfigures the failure-detected memory and boots. Disable: Cancels boot and turns off the power.
NUMA	[Enable] Disable	Enables / disables NUMA memory configuration.

Devices Screen

Table 27 describes the menu items available on the Devices screen. Default values appear in brackets.

Table 27. Devices Screen

Primary Menu Item	Sub Menu Item	Options	Description
VGA	Onboard VGA	[Enable] Disable	Enables / disables on-board VGA.

Server Management Screen

Table 28 describes the menu items available on the Server Management screen. Default values appear in brackets.

Table 28. Server Management Screen

Primary Menu Item	Sub Menu Item	Options	Description
Console Redirection	COM1 Console Redirection	Press <Enter>	Pressing <Enter> invokes the submenu to configure COM1 console redirection.
Management LAN	DHCP	[Enable] Disable	Enable: Acquires IP address of LAN port by DHCP. Disable: Requires the manual settings.
	IP Address	[255.255.255.255]	IP address of management LAN port. Available when DHCP is disabled.
	Subnet Mask	[255.255.255.255]	Subnet mask of management LAN port. Available when DHCP is disabled.
	Default Gateway	[255.255.255.255]	Default gateway address of management LAN port. Available when DHCP is disabled.
SEL Clear	N/A	Press <Enter>.	Pressing <Enter> prompts the user to respond Yes or No. Yes: Clears the SEL. No: Aborts the action.

Table 29. COM1 Console Redirection

Menu Item	Options	Description
Headless Support	[Enable] Disable	Enable: Outputs firmware or EFI console input/output to COM1. Provides SPCR or HCDP to OS. Disable: Does not output firmware or EFI console input/output to COM1. Does not provide SPCR or HCDP to OS. When the valid VGA is not mounted, "Enable" is set.
COM1 Speed	9600 bps [19200bps]	Uses the communication speed specified when console redirection is valid.

System Information Screen

System information as firmware version, and board, chassis, and product information are displayed.

```
System Information

SAL Revision:xx-xx
BMC Firmware Revision:xx-xx
Board Part Number:xxxxxxxx
Board Serial Number:xxxxxxxx
Product Part Number:xxxxxxxx
Product Serial Number:xxxxxxxx
Chassis Part Number:xxxxxxxx
Chassis Serial Number:xxxxxxxx

Exit
```

Configuring Serial-Over LAN

1. Open “System Setup Menu” on the screen.
2. Choose “Server Management”:

```
System Setup Menu
Main
Processor
Memory
Devices
Server Management
Security

Save changes and Exit
Discard changes and Exit
Restore Defaults
Exit
```

3. Choose “Console Redirection”:

Server Management Menu
Examine and set server management parameters.

Console Redirection
Management LAN
SEL Clear
Exit

4. Choose “COM1 Console Redirection”:

Console Redirection Menu
Examine and set console redirection parameters.

COM1 Console Redirection
Exit

5. Set the COM1 Speed to 9600/19200:

The baud rate must be equal to the speed specified for serial redirection functions of the BIOS, and the speed used for the configuration of the boot loader and operating system.

COM1 Console Redirection Menu
Examine and set console redirection parameters.

Headless Support [Enable]
COM1 Speed [19200 bps]
Exit

Use Enter to change value.

6. By default, a null user and null password is available from SOL.
7. The user name and user password are configurable with the SYSCFG utility. For information about this utility, see the *EFI Utility User's Guide*.
8. Bundled management software will use User #10. Do not use this user number if you plan to use the management software that is included with your server system.

5 Troubleshooting

Initial Troubleshooting Steps

The Intel® Server System SR9000MK4U implements indicators to display the system status. These are useful as a first step in identifying a problem. Begin troubleshooting by using the table below to view symptoms and solutions. If you do not find the answer you need in the table, continue with the information that follows the table.

Table 30. Troubleshooting Guide

Location	Symptom	Solution
Power LED	System does not power up. All LED are turned off.	Check that the power input cable is connected properly. Check that the power distribution panel/board is turned on and properly provides AC power. Check that the power modules are installed properly. Check that the power modules are configured. Once disconnect and reconnect the power cable and then confirm the symptom again. Check that the power cable, etc. between front panel and the main board are connected properly.
Power Fault LED	System powers on, but then turns off quickly. Power fault LED (orange) is on.	Check that the power input cable is properly connected. Check that the power modules are installed properly. Check that the power modules are configured.
General Fault LED	System powers on, but then turns off. General fault LED (orange) is on.	Check that the processor and MVR are installed properly in the system. Check that the MVR power cable is properly connected. Check that the processor is configured.

Table 30. Troubleshooting Guide

Location	Symptom	Solution
Cooling Fault LED	System powers on, but then turns off quickly. Cooling Fault LED (orange) is on.	<p>Check that the cooling fan module is installed properly.</p> <p>Check that no foreign matter is put in cooling fan module.</p> <p>Check that the intake/exhaust air is flowing.</p>
	After the power-on, cooling fault LED (orange) is on or blinks.	<p>Check that the cooling fan module is installed properly.</p> <p>Check that no foreign matter is put in cooling fan module.</p> <p>Check that intake/exhaust air flows.</p>
Power Fault LED	After system powers on, Power Fault LED (orange) is on or blinks	<p>Check that the power input cable is properly connected.</p> <p>Check that the power modules are installed properly.</p> <p>Check that the power modules are configured.</p>
Video	System turns on, but screen is blank.	<p>Check that the display is plugged in.</p> <p>Check that the display is turned on.</p> <p>Check that the display cable is properly connected.</p> <p>Replace the display.</p>
	The state of screen is unusual.	<p>Check that the display cable is properly connected.</p> <p>Check that the brightness and contrast on the display are properly set.</p> <p>Check that the proper video driver is installed.</p> <p>Check that the refresh rate setting matches the display specification.</p> <p>Replace the display.</p>
Keyboard	Keyboard does not work.	<p>Check that the keyboard USB cable is properly connected.</p> <p>Disconnect and reconnect the USB cable and retry.</p> <p>Replace the keyboard.</p>
Mouse	Mouse does not work normally.	<p>Check that the mouse USB cable is properly connected.</p> <p>Disconnect and reconnect the USB cable and retry.</p> <p>Replace the mouse.</p>

Table 30. Troubleshooting Guide

Location	Symptom	Solution
Processor	System does not recognize part of the processors that were installed.	<p>Check that the processor/MVR are installed properly.</p> <p>Check that the MVR power cable is properly connected.</p> <p>Check that the processor is configured.</p>
Memory Box	Memory capacity is indicated less than actual loaded capacity.	<p>Check if memory is used in Mirror Mode (green memory box mirror LED on).</p> <p>Check that the memory box is properly connected.</p> <p>Check that the DIMM is installed properly in the memory box.</p> <p>Check that the DIMM is configured.</p>
Memory Box	Memory Box Attention LED (orange) is on.	Swap the memory box after confirming the memory is in mirror mode (green memory box mirror LED is on).
Hard Drive	Hard drive is not properly recognized. Red hard drive LED indicates a fault.	<p>Check that the hard drive is installed properly.</p> <p>Check that the hard drive is configured.</p> <p>Check that the SAS/SATA cable, etc. between hard drive backplane and main board in the system are properly connected.</p>
DVD Drive	DVD drive does not work.	<p>Check that the IDE cable, etc. between the DVD drive and main board in the system are properly connected.</p> <p>Replace the DVD-ROM drive.</p>
Network	Network is not available for communication.	<p>Check that the network cable is properly connected.</p> <p>Check that the device of the network destination is turned on.</p>
USB Device	A connected device is not recognized.	<p>The front ports are USB 1.1. The rear ports are USB 2.0.</p> <p>Check that the USB device and cable are properly connected.</p> <p>Check that the USB cable, etc. between front panel and main-board are properly connected.</p>
I/O Card	I/O card is not properly recognized. Attention LED (yellow) blinks.	<p>Check that the I/O card is installed into the slot properly.</p> <p>Check that the variety of I/O card corresponds to the installed slot.</p>

Table 30. Troubleshooting Guide

Location	Symptom	Solution
I/O Device	I/O device is not recognized.	Check that the cable between I/O card and I/O device is properly connected. Check that the I/O device is turned on.

Collecting System State Information

If the information in the table above did not resolve your problem, continue with the troubleshooting steps below.

1. Collect information: Collect information about the state at which the problem occurs. POST (Power On Self Test) code and SEL (System Event Log) information are necessary. System log information for the operating system may also be needed by your service representative.
2. Take appropriate actions: Look up tables based on the collected information and take appropriate actions.
3. Execute system diagnosis program: If you need to replace components, execute system diagnosis program following the component replacement to confirm that the system is working correctly following the replacement.

The following figure shows the system states possible. Below the figure are steps to follow to troubleshoot the system at each state. If you know the state the system is in at the time the problem occurs, collect the state information for that specific state.

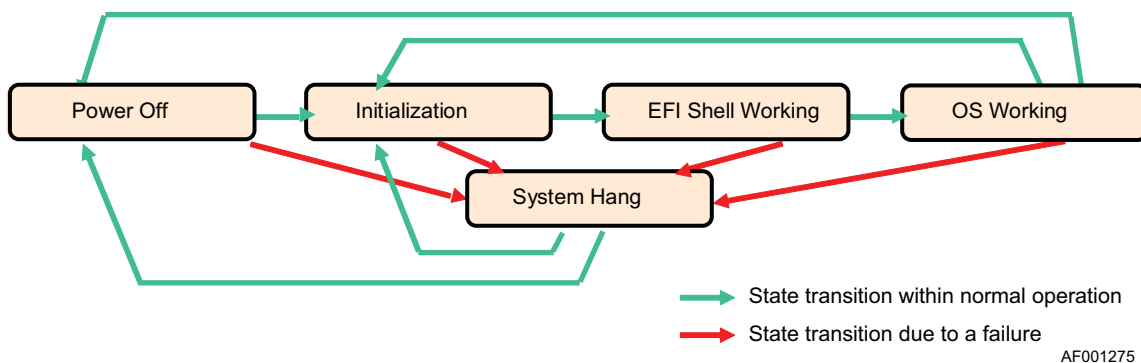

Figure 134. State Transition Diagram

Power Off State

1. Power up the system.
2. Wait for the EFI shell to begin.
3. Use the selview utility to obtain the system event log information. For instructions, see [“How to Use Selview to Read the System Event Log” on page 160](#).
4. Attempt to boot the operating system.
5. Obtain operating system log information. For instructions, see [“How to Collect System and Error Logs” on page 160](#).
6. Shut down the system.

If you reproduced the problem, read the POST code. For instructions, see [“How to Read the POST Codes” on page 159](#).

If the system seems to have moved to the system hang status during the procedure, see [“System Hang Status” on page 159](#).

Initialization State

1. Read the POST code. For instructions, see [“How to Read the POST Codes” on page 159](#).
2. Wait for the EFI shell begin working.
3. Use the selview utility to obtain the system event log information. For instructions, see [“How to Use Selview to Read the System Event Log” on page 160](#).
4. Attempt to boot the operating system.
5. Obtain operating system log information. For instructions, see [“How to Collect System and Error Logs” on page 160](#).
6. Shut down the system.

If you reproduced the problem, read the POST code. For instructions, see [“How to Read the POST Codes” on page 159](#).

If the system seems to have moved to the system hang status during the procedure, see [“System Hang Status” on page 159](#).

EFI Shell Working State

1. Read the POST code. For instructions, see [“How to Read the POST Codes” on page 159](#).
2. Use the selview utility to obtain the system event log information. For instructions, see [“How to Use Selview to Read the System Event Log” on page 160](#).
3. Attempt to boot the operating system.
4. Obtain operating system log information. For instructions, see [“How to Collect System and Error Logs” on page 160](#).
5. Shut down the system.

If you reproduced the problem, read the POST code. For instructions, see [“How to Read the POST Codes” on page 159](#).

If the system seems to have moved to the system hang status during the procedure, see [“System Hang Status” on page 159](#).

OS Working Status

1. Read POST code.
2. Obtain operating system log information. For instructions, see [“How to Collect System and Error Logs” on page 160](#).
3. Reboot the system to the EFI shell.
4. Use the selview utility to obtain the system event log information. For instructions, see [“How to Use Selview to Read the System Event Log” on page 160](#).
5. Shut down the system.

If you reproduced the problem, read the POST code. For instructions, see [“How to Read the POST Codes” on page 159](#).

If the system seems to have moved to a system hang status, follow the steps under [System Hang Status](#), below.

System Hang Status

1. Read the POST code. For instructions, see [“How to Read the POST Codes” on page 159](#).
2. Boot the system to the EFI shell.
3. Use the selview utility to obtain the system event log information. For instructions, see [“How to Use Selview to Read the System Event Log” on page 160](#).
4. Attempt to boot the operating system.
5. Obtain operating system log information. For instructions, see [“How to Collect System and Error Logs” on page 160](#).
6. Shut down the system.

If you reproduced the problem, read the POST code. For instructions, see [“How to Read the POST Codes” on page 159](#).

If the system seems to have again reached the system hang status, repeat the procedure. If you experience the system hang status multiple times, stop collecting information.

How to Read the POST Codes

The POST code decimal number is located inside the chassis at the right side. See the figure below.

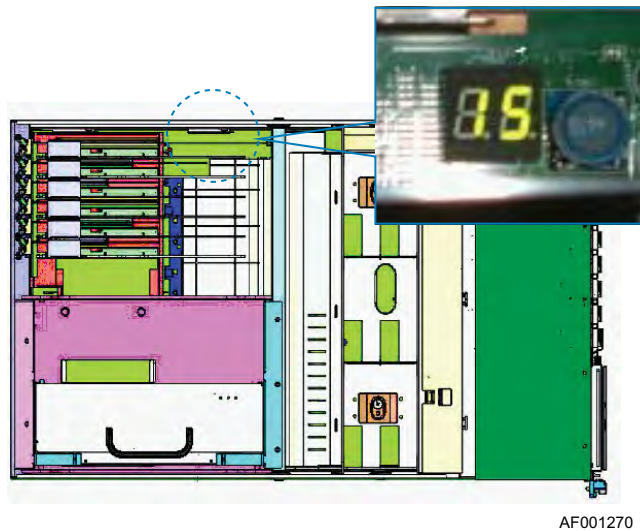

Figure 135. Location of POST Code LED

How to Use Selview to Read the System Event Log

1. Use the EFI utility “selview” to acquire system event log (SEL) information. See the *EFI Utility User’s Guide* for help with this utility.
2. Record the output of selview utility.

How to Collect System and Error Logs

Collecting System and Error Logs from a Linux* System

1. Login as root.
2. Prepare an external storage device, such as USB flash memory drive, and mount it as an appropriate directory.
3. Execute the cd command to move to the “/var/log” directory.
`cd /var/log`
4. Copy all of the files in this directory to the external storage device.

Collecting System and Error Logs from a Windows* System

1. Prepare an external storage device, such as USB memory drive, and connect it to the system. Confirm the drive letter of the device.
2. From the Start menu, select “Control Panel” and then “Administrative Tools”.
3. Click on “Event Viewer” to open it.
4. Select “System” in the tree display section, and select “Save Log File As” from the Operation menu on the menu bar.
5. A dialog box “Save System Log As” opens.
 - Select an appropriate drive letter in the “Save in” list.
 - Enter “system.evt” as the file name.
6. Click Save.
7. Select “Save Log File As” from the Operation menu on the menu bar.
8. The “Save System Log As” dialog box opens.
 - Select an appropriate drive letter in the “Save in” list.
 - Select “CSV (comma separated value)” as the file type.
 - Change the file name to “system.csv”.
9. Click Save.
10. Select “Security” in the tree display section.
11. Select “Save Log File As” from the Operation menu on the menu bar.
12. The “Save Security Log As” dialog box opens.

- Select an appropriate drive letter in the “Save in” list.
 - Enter “security.evt” as the file name.
13. Click Save.
 14. Select “Save Log File As” from the Operation menu on the menu bar.
 15. The dialog box, “Save Security Log As”, opens.
 - Select an appropriate drive letter in the “Save in” list.
 - Select “CSV (comma separated value)” as the file type.
 - Change the file name to “security.csv”.
 16. Click Save.
 17. Select “Application” in the tree display section.
 18. Select “Save Log File As” from the Operation menu on the menu bar.
 19. The dialog box, “Save Application Log As” opens.
 - Select an appropriate drive letter in the “Save in” list.
 - Enter “ap.evt” as the file name.
 20. Click Save.
 21. Select “Save Log File As” from the Operation menu on the menu bar.
 22. The dialog box, “Save Application Log As”, opens.
 - Select an appropriate drive letter in the “Save in” list.
 - Select “CSV (comma separated value)” as the file type.
 - Change the file name to “ap.csv”.
 23. Click Save.
 24. Select “Exit” from the File menu on the menu bar to end the operation.
 25. Open the command prompt.
 26. Execute the following command:

```
dir \<WINDOWS>\system32 /s > <X>:\system32.txt
```

 where:
 - ✧ <WINDOWS> is the name of directory in which the Windows operating system is installed. It is “windows” by default.
 - ✧ <X> is the drive letter for your external storage device.
 27. From the command prompt, execute.

```
dir \<WINDOWS>\system32\drivers > <X>:\drivers.txt
```
 28. Type “exit” to close the command prompt.
 29. Use Explorer* to confirm that the following files have been created on the external storage:

```
system.evt
system.csv
security.evt
```

```
security.csv  
ap.evt  
ap.csv  
system32.txt  
drivers.txt
```

30. Use Notepad to confirm the following files contain some texts:
system32.txt
drivers.txt
31. Stop the external storage and remove the device from the system.

Taking Corrective Action

See “POST Codes” on page 171 for suggested corrective actions.

Appendix A: Console Setup

On-board VGA

The Intel® Server System SR9000MK4U server can output the SAL and EFI displays to on-board VGA. This subsection describes how to enable/disable the on-board VGA.

1. Select **System Setup** from the Boot Maintenance Menu of the EFI Boot Manager. See [“The Extensible Firmware Interface \(EFI\) Boot Manager” on page 131](#) for details about the Boot Maintenance Menu.
2. Select **Devices** from the System Setup Menu.

System Setup Menu

Main
Processor
Memory
Devices
Server Management
Security

Save changes and Exit
Discard changes and Exit
Restore Defaults
Exit

3. Select **VGA** from the Devices Menu.

Devices Menu

Examine and set system parameters for built-in Devices.

IDE Controller
VGA
Exit

4. Select **Onboard VGA** from the VGA Menu. Set the option to either **Enable** or **Disable**. When you want to use on-board VGA, set it to **Enable**.

VGA Menu

Examine and set VGA parameters.

Onboard VGA [Enable]

Exit

Use Enter to change value.

5. Select **Exit** twice and return to the System Setup Menu.
6. Select **Save changes and Exit** to end the System Setup.

Serial Console

The Intel® Server System SR9000MK4U server supports headless function that redirects the VGA output and keyboard input of SAL and EFI to the COM1 port input/output. This subsection describes how to enable/disable the headless function and how to set baud rate.

1. Select **System Setup** from the Boot Maintenance Menu of the EFI Boot Manager. See [“The Extensible Firmware Interface \(EFI\) Boot Manager” on page 131](#) for details about the Boot Maintenance Menu.
2. Select **Server Management** from the System Setup Menu.

System Setup Menu

Main
Processor
Memory
Devices
Server Management
Security

Save changes and Exit
Discard changes and Exit
Restore Defaults
Exit

3. Select **Console Redirection** from the Server Management Menu.

Server Management Menu

Examine and set server management parameters.

Console Redirection
Management LAN
SEL Clear
Exit

4. Select **COM1 Console Redirection** on the Console Redirection Menu screen.

Console Redirection Menu

Examine and set console redirection parameters.

COM1 Console Redirection
Exit

5. Select **Headless Support** on the COM1 Console Redirection Menu and set it to **Enable** or **Disable**. When you want to use headless function, set it to **Enable**.

COM1 Console Redirection Menu

Examine and set console redirection parameters.

Headless Support [Disable]
COM1 Speed [19200bps]
Exit

Use Enter to change value.

6. Select **COM1 Speed** and set it to 9600 bps or 19200 bps. Set the baud rate that is set to the terminal connected to COM1 port.
7. Select **Exit** three times to return to the System Setup Menu.
8. Select **Save changes and Exit** to end the System Setup utility.

Appendix B: Cabling

This appendix provides a a brief guideline about how to correctly attach and detach cables to prevent damage to the cable, or to the connector on the cable end or the server board. This appendix also provides photographs of the cable connections in the server system.

Working with Ribbon Cables

Make sure to detach (or attach) the flat cable assembly from the main board according to the following instructions.

- Always hold the ribbon cable parallel to the connector you are inserting it onto or removing it from.
- Do not remove the cable at an angle.
- Do not pull on the cable itself; only grasp the connector when connecting or disconnecting a cable.
- Do not pull the cable from the connector by pulling on the label tag.
- Do not crush or pinch the cable.

Cable Connections

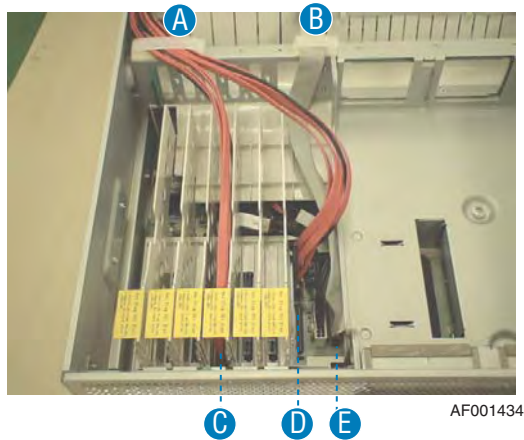

A. SATA cable clip	D. SATA 0 - 3 on-board connector
B. IDE cable clip	E. IDE connector
C. SATA 4-7 connector, on installed add-in card	

Figure 136. Connections Near Power Supply Box and PCI Card Divider

Note: The figure above shows the system with the power supply box removed.

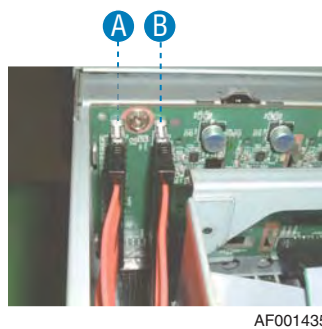

A. SATA 0 - 3 connector on hard drive backplane	B. SATA 4 - 7 connector on hard drive backplane
-------------------------------------------------	-------------------------------------------------

Figure 137. SATA Connections on Hard Drive Backplane

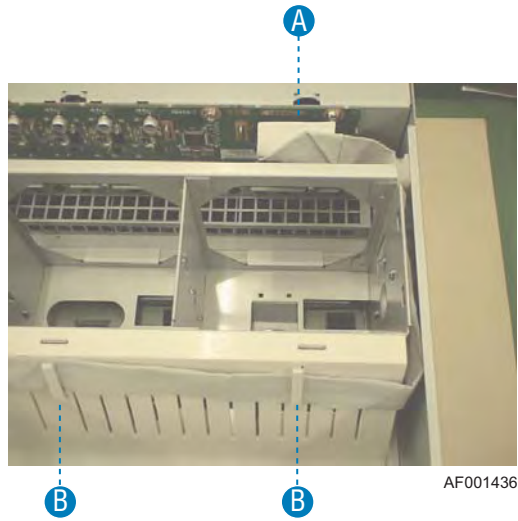

A. IDE connector on hard drive backplane	B. IDE cable routing clips on air flow guide
------------------------------------------	----------------------------------------------

Figure 138. IDE Connection and Cable Routing

Note: The figure above shows the system with the fans removed.

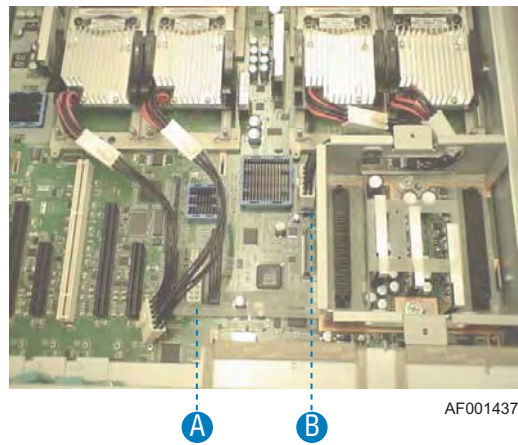

A. MVR connector for processors 1 and 2	B. MVR connector for processors 3 and 4
-----------------------------------------	-----------------------------------------

Figure 139. MVR Connectors

Note: The figure above shows the system with the PCI card divider and the power supply box removed.

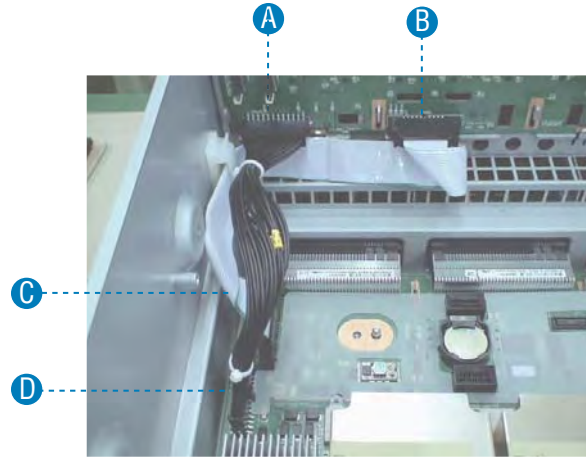

AF001438

A. Control panel power connection on hard drive backplane	C. Control panel data connector on server board
B. Control panel data connector on hard drive backplane	D. Control panel power cable on server board

Appendix C: POST Codes

Table 31. POST Codes Generated by the BMC and Logged at the Seven Segment LED

Code		Descriptions	Classification	Operation to Recover
0	0	reserved		
0	1	SRAM Check Started	Progress	
0	2	SRAM Check Completed	Progress	
0	3	Active side BMC F/W binary file checking	Progress	
0	4	Spool side BMC F/W binary file checking	Progress	
0	5	File check completed	Progress	
0	6	File update process started (normal process)	Progress	
0	7	File update process completed (normal process)	Progress	
0	8	File update process started (recovery process)	Progress	
0	9	File update process completed (recovery process)	Progress	
0	A	FWM Boot Block procedure completed	Progress	
0	B	Request to start F/W in Non Boot Block	Progress	
0	C	reserved		
0	D	reserved		
0	E	reserved		
0	F	reserved		
1	0	reserved		
1	1	reserved		
1	2	reserved		
1	3	reserved		
1	4	reserved		
1	5	reserved		
1	6	reserved		
1	7	reserved		
1	8	WDT overflow occurred	Error	BMC Error
1	9	Active side file recovery error	Error	Replace MB

Table 31. POST Codes Generated by the BMC and Logged at the Seven Segment LED

Code		Descriptions	Classification	Operation to Recover
1	A	Active side file update error	Error	
1	B	Checksum error detected in active side	Error	
1	C	SRAM check error (SRAM testing)	Error	
1	D	SRAM check error (Hardware detects error in SRAM testing)	Error	
1	E	Checksum error detected in both banks	Error	
1	F	SRAM Parity error detected	Error	
2	0	F/W in Non Boot Block started	Progress	
2	1	Initialization process of OS started	Progress	
2	2	AMI initialization started	Progress	
2	3	First process of task initialization started	Progress	
2	4	AMI task initialization, generation started	Progress	
2	5	Second process of task initialization started	Progress	
2	6	AMI initialization completed	Progress	
2	7	OS booting process started	Progress	
2	8	Task booting process started	Progress	
2	9	reserved		
2	A	reserved		
2	B	reserved		
2	C	reserved		
2	D	reserved		
2	E	reserved		
2	F	reserved		
3	0	Message handler started	Progress	
3	1	PDK initialization process started	Progress	
3	2	Task generation process started	Progress	
3	3	BMC initialization completed	Progress	
3	4	reserved		
3	5	reserved		
3	6	reserved		
3	7	reserved		
3	8	reserved		
3	9	reserved		

Table 31. POST Codes Generated by the BMC and Logged at the Seven Segment LED

Code		Descriptions	Classification	Operation to Recover
3	A	reserved		
3	B	reserved		
3	C	Detailed log collection started by WDT overflow	Error	BMC Error
3	D	BMC restarted by WDT overflow	Error	
3	E	Failed in task generation	Error	
3	F	Illegal or mismatch format of GUID	Error	
4	0	CPU0 Thermal Trip	Error, error event logged to SEL	
4	1	CPU0 Configuration Error (Absent)	Error, error event logged to SEL	SEL List
4	2	CPU0 Configuration Error (Disabled)	Error, error event logged to SEL	
4	3	CPU0 Configuration Error (Illegal Type)	Error, error event logged to SEL	
4	4	CPU0 I2C Access Error (PIROM)	Error, error event logged to SEL	
4	5	CPU0 I2C Access Error (Temperature Monitor)	Error, error event logged to SEL	
4	6	CPU1 Thermal Trip	Error, error event logged to SEL	
4	7	CPU1 Configuration Error (Disabled)	Error, error event logged to SEL	
4	8	CPU1 Configuration Error (Illegal Type)	Error, error event logged to SEL	
4	9	CPU1 Configuration Error (Different Type)	Error, error event logged to SEL	
4	A	CPU1 I2C Access Error (PIROM)	Error, error event logged to SEL	
4	B	CPU1 I2C Access Error (Temperature Monitor)	Error, error event logged to SEL	
4	C	CPU2 Thermal Trip	Error, error event logged to SEL	
4	D	CPU2 Configuration Error (Disabled)	Error, error event logged to SEL	
4	E	CPU2 Configuration Error (Illegal Type)	Error, error event logged to SEL	
4	F	CPU2 Configuration Error (Different Type)	Error, error event logged to SEL	
5	0	CPU2 I2C Access Error (PIROM)	Error, error event logged to SEL	
5	1	CPU2 I2C Access Error (Temperature Monitor)	Error, error event logged to SEL	SEL List
5	2	CPU3 Thermal Trip	Error, error event logged to SEL	

Table 31. POST Codes Generated by the BMC and Logged at the Seven Segment LED

Code		Descriptions	Classification	Operation to Recover
5	3	CPU3 Configuration Error (Disabled)	Error, error event logged to SEL	
5	4	CPU3 Configuration Error (Illegal Type)	Error, error event logged to SEL	
5	5	CPU3 Configuration Error (Different Type)	Error, error event logged to SEL	
5	6	CPU3 I2C Access Error (PIROM)	Error, error event logged to SEL	
5	7	CPU3 I2C Access Error (Temperature Monitor)	Error, error event logged to SEL	
5	8	MB Power Failure (Main 5.0V)	Error, error event logged to SEL	
5	9	MB Power Failure (Main 3.3V)	Error, error event logged to SEL	
5	A	MB Power Failure (Main 2.5V)	Error, error event logged to SEL	
5	B	MB Power Failure (Main 1.8V)	Error, error event logged to SEL	
5	C	MB Power Failure (Main 1.5V)	Error, error event logged to SEL	
5	D	MB Power Failure (Main 1.2V0)	Error, error event logged to SEL	
5	E	MB Power Failure (Main 1.2V1)	Error, error event logged to SEL	
5	F	MB Power Failure (Main 1.2V2)	Error, error event logged to SEL	
6	0	MB Power Failure (Voltage Type Unknown)	Error, error event logged to SEL	
6	1	MVR0 Power Failure	Error, error event logged to SEL	SEL List
6	2	MVR1 Power Failure	Error, error event logged to SEL	
6	3	MVR2 Power Failure	Error, error event logged to SEL	
6	4	MVR3 Power Failure	Error, error event logged to SEL	
6	5	PS0 Configuration Error (Absent)	Error, error event logged to SEL	
6	6	PS0 Configuration Error (Illegal Type)	Error, error event logged to SEL	
6	7	PS0 Configuration Error (Insufficient Resources)	Error, error event logged to SEL	
6	8	PS1 Configuration Error (Insufficient Resources)	Error, error event logged to SEL	
6	9	PS1 Configuration Error (Different Type)	Error, error event logged to SEL	

Table 31. POST Codes Generated by the BMC and Logged at the Seven Segment LED

Code		Descriptions	Classification	Operation to Recover
6	A	PS0 Power Failure (Insufficient Resources)	Error, error event logged to SEL	
6	B	PS1 Power Failure (Insufficient Resources)	Error, error event logged to SEL	
6	C	CPU / MMR Overinstall (PS Insufficient Resources)	Error, error event logged to SEL	
6	D	MB I2C Access Error (Sensor0)	Error, error event logged to SEL	
6	E	MB I2C Access Error (Sensor1)	Error, error event logged to SEL	
6	F	MB I2C Access Error (Voltage Margin0)	Error, error event logged to SEL	
7	0	MB I2C Access Error (Voltage Margin1)	Error, error event logged to SEL	
7	1	MB I2C Access Error (Clock Generator)	Error, error event logged to SEL	SEL List
7	2	MB PLL Lock Error (NDC30)	Error, error event logged to SEL	
7	3	MB PLL Lock Error (NDC31)	Error, error event logged to SEL	
7	4	MMR0 Power Failure	Error, error event logged to SEL	
7	5	MMR1 Power Failure	Error, error event logged to SEL	
7	6	MMR2 Power Failure	Error, error event logged to SEL	
7	7	MMR3 Power Failure	Error, error event logged to SEL	
7	8	MMR0 Removed (Wrong Operation)	Error, error event logged to SEL	
7	9	MMR1 Removed (Wrong Operation)	Error, error event logged to SEL	
7	A	MMR2 Removed (Wrong Operation)	Error, error event logged to SEL	
7	B	MMR3 Removed (Wrong Operation)	Error, error event logged to SEL	
7	C	CPU0 Configuration Error (Installation Rule)	Error, error event logged to SEL	
7	D	CPU1 Configuration Error (Installation Rule)	Error, error event logged to SEL	
7	E	CPU2 Configuration Error (Installation Rule)	Error, error event logged to SEL	
7	F	Chassis Intrusion detected	Error, error event logged to SEL	
8	X	reserved		

Table 31. POST Codes Generated by the BMC and Logged at the Seven Segment LED

Code		Descriptions	Classification	Operation to Recover
9	0	Multiple Machine Check Interrupt	Error, error event logged to SEL	
9	1	MB Config Access Error (NDC30)	Error, error event logged to SEL	SEL List
9	2	MB Config Access Error (NDC31)	Error, error event logged to SEL	
9	3	MB Config Access Error (ESB2)	Error, error event logged to SEL	
9	4	MB Config Access Error (PXH)	Error, error event logged to SEL	
9	5	MB HSCP Link Error (NDC30 / Port1)	Error, error event logged to SEL	
9	6	MB HSCP Link Error (NDC31 / Port1)	Error, error event logged to SEL	
9	7	MB Bit Deskew Latency Error (NDC30 / Port0)	Error, error event logged to SEL	
9	8	MB Bit Deskew Latency Error (NDC30 / Port1)	Error, error event logged to SEL	
9	9	MB Bit Deskew Latency Error (NDC30 / Port2)	Error, error event logged to SEL	
9	A	MB Bit Deskew Latency Error (NDC31 / Port0)	Error, error event logged to SEL	
9	B	MB Bit Deskew Latency Error (NDC31 / Port1)	Error, error event logged to SEL	
9	C	MB Bit Deskew Latency Error (NDC31 / Port2)	Error, error event logged to SEL	
9	D	MB PCI-Express Link Error	Error, error event logged to SEL	
9	E	MB Illegal Machine Check Interrupt	Error, error event logged to SEL	
9	F	reserved		
A	0	HDDPL I2C Access Error (SEEPROM)	Error, error event logged to SEL	
A	2	reserved		
A	3	reserved		
A	4	reserved		
A	5	reserved		
A	5	reserved		
A	6	reserved		
A	7	reserved		
A	8	reserved		
A	9	reserved		

Table 31. POST Codes Generated by the BMC and Logged at the Seven Segment LED

Code		Descriptions	Classification	Operation to Recover
A	B	reserved		
A	C	reserved		
A	D	reserved		
A	E	reserved		
A	F	reserved		
B	7	reserved		
B	8	reserved		
B	9	reserved		
B	A	reserved		
B	B	reserved		
B	C	reserved		
B	D	reserved		
B	E	reserved		
B	F	reserved		
C	X	reserved		
D	X	reserved		
E	X	reserved		
F	X	reserved		

Table 32. POST Codes Generated by SAL and Logged at the Seven Segment LED

No	Code	Description	Operation to Recover
1	100	BSP selection W Mutex service initialization NVSDA service initialization AP synchronization control Chipset low-level initialization PAL status check	Check previous SEL
2	1EB	RTC initialization	
3	1E3	Super IO initialization	

Table 32. POST Codes Generated by SAL and Logged at the Seven Segment LED

No	Code	Description	Operation to Recover
4	1EA	Console initialization	
5	1F5	Chipset initialization Memory initialization	
6	1F4	Recovery SDA initialization	
7	1EC	SAL_A shadowing Both BSP and AP jump to the shadowing code.	
8	1E2	Decides whether recovery is necessary	
9	1E4	Decides whether recovery is necessary	
10	1E6	FIT checksums	
11	1E7	Recovery POST termination	
12	006	Finalize memory layout Memory attribut register initialization	
13	016	SAL data area initialization	
14	014	SAL shadowing	
15	0F2	FREQ_BASE acquisition	
16	013	PAL shadowing	
17	012	IA32BIOS shadowing	
18	029	Wake up an AP Execute and guard AP self-test Code directly calls and initializes POST task for AP self-test Reboot the memory or processor that has errored	
19	0F1	Memory-based Mutex* service initialization	Check previous SEL
20	0F0	Runtime memory allocator initialization	
21	oD1	Error record buffer initialization	
22	0D2	MCA handler initialization	
23	033	Initialize interrupt vector table (IVT)	
24	oCB	Multiple host bus bridge initialization	
25	0D6	PCI initialization	
26	001	Transfer to virtual mode	
27	015	IA32BIOS execution	
28	004	Transfer to physical mode	
29	oF8	Initialize IDE controller	
30	0F4	PCI initialization after returning from IA32 BIOS	
31	oF3	RAS late initialization	

Table 32. POST Codes Generated by SAL and Logged at the Seven Segment LED

No	Code	Description	Operation to Recover
32	0F5	Clear error flags in chipset	
33	0D0	EFI code shadowing EFI execution	
34	AF-15	EFI POST task execution	

Table 33. Error POST Codes Generated by SAL



No	Code	Description	Classification	Operation to Recover
1	0xC000~0xC003	CPU0 failure	Error	Check SEL list
2	0xC004~0xC007	CPU1 failure	Error	
3	0xC008~0xC00B	CPU2 failure	Error	
4	0xC00C~0xC00F	CPU3 failure	Error	
5	0xC020~0xC021	Chipset(NDC3) failure	Error	
6	0xC030	FWH failure	Error	
7	0xC037	Unsupported processor \	Error	
8	0xC03F	FWH failure	Error	
9	0xC081	Detected illegal DIMM loading pattern or unsupported DIMM.	Error	
10	0xC082	No usable memory	Error	
11	0xC08B	Memory Controller failure	Error	
12	0xC0D0	Error detected.	Error	
13	0x8002	Unexpected failure	Error	Please check previous SEL
14	0x8003	Unexpected failure	Error	
15	0x8004	Chipset (NDC3) failure	Error	
16	0x8005	Processor failure	Error	
17	0x8006	Processor failure	Error	
18	0x8008	Unexpected failure	Error	
19	0x800A	Unexpected failure	Error	
20	0x800B	Unexpected failure	Error	
21	0x800C	Unexpected failure	Error	
22	0x8014	Unexpected failure	Error	
23	0x8015	Unexpected failure	Error	
24	0x8016	Unexpected failure	Error	

Table 33. Error POST Codes Generated by SAL

No	Code	Description	Classification	Operation to Recover
25	0x8017	Unexpected failure	Error	
26	0x8018	Unexpected failure	Error	
27	0x8019	Unexpected failure	Error	
28	0x8020	Unexpected failure	Error	
29	0xC086	Unexpected failure detected while initializing memory.	Error	
30	0xC090–C092	OS machine check handler is not registered or not valid	Error	Please check previous SEL
31	0xC0E0	Unexpected failure	Error	
32	0xC0E1	Unexpected failure in the SAL machine check handler.	Error	
33	0xC0E2	Unexpected failure in the SAL machine check handler.	Error	
34	0xC0E3	Unexpected failure in the SAL machine check handler.	Error	
35	0xC0E4	Unexpected failure in the SAL machine check handler.	Error	
36	0xC0E6	Unexpected failure	Error	
37	0xA108	Unexpected failure in the machine check handler.	Error	

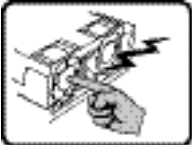
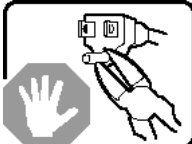

Appendix D: Installation/Assembly Safety Instructions

English

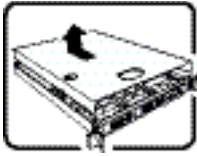
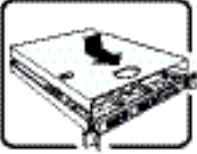
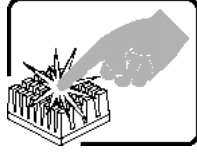
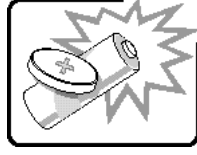
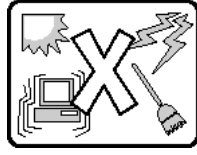
	<p>The power supply in this product contains no user-serviceable parts. Refer servicing only to qualified personnel.</p>
	<p>Do not attempt to modify or use the supplied AC power cord if it is not the exact type required. A product with more than one power supply will have a separate AC power cord for each supply.</p>
	<p>The power button on the system does not turn off system AC power. To remove AC power from the system, you must unplug each AC power cord from the wall outlet or power supply.</p> <p>The power cord(s) is considered the disconnect device to the main (AC) power. The socket outlet that the system plugs into shall be installed near the equipment and shall be easily accessible.</p>
	<p>SAFETY STEPS: Whenever you remove the chassis covers to access the inside of the system, follow these steps:</p> <ol style="list-style-type: none"> 1. Turn off all peripheral devices connected to the system. 2. Turn off the system by pressing the power button. 3. Unplug all AC power cords from the system or from wall outlets. 4. Label and disconnect all cables connected to I/O connectors or ports on the back of the system. 5. Provide some electrostatic discharge (ESD) protection by wearing an antistatic wrist strap attached to chassis ground of the system-any unpainted metal surface-when handling components. 6. Do not operate the system with the chassis covers removed.

	<p>After you have completed the six SAFETY steps above, you can remove the system covers. To do this:</p> <ol style="list-style-type: none"> 1. Unlock and remove the padlock from the back of the system if a padlock has been installed. 2. Remove and save all screws from the covers. 3. Remove the cover(s).
	<p>For proper cooling and airflow, always reinstall the chassis covers before turning on the system. Operating the system without the covers in place can damage system parts. To install the covers:</p> <ol style="list-style-type: none"> 1. Check first to make sure you have not left loose tools or parts inside the system. 2. Check that cables, add-in boards, and other components are properly installed. 3. Attach the covers to the chassis with the screws removed earlier, and tighten them firmly. 4. Insert and lock the padlock to the system to prevent unauthorized access inside the system. 5. Connect all external cables and the AC power cord(s) to the system.
	<p>A microprocessor and heat sink may be hot if the system has been running. Also, there may be sharp pins and edges on some board and chassis parts. Contact should be made with care. Consider wearing protective gloves.</p>
	<p>Danger of explosion if the battery is incorrectly replaced. Replace only with the same or equivalent type recommended by the equipment manufacturer. Dispose of used batteries according to manufacturer's instructions.</p>
	<p>The system is designed to operate in a typical office environment. Choose a site that is:</p> <ul style="list-style-type: none"> • Clean and free of airborne particles (other than normal room dust). • Well ventilated and away from sources of heat including direct sunlight. • Away from sources of vibration or physical shock. • Isolated from strong electromagnetic fields produced by electrical devices. • In regions that are susceptible to electrical storms, we recommend you plug your system into a surge suppresser and disconnect telecommunication lines to your modem during an electrical storm. • Provided with a properly grounded wall outlet. • Provided with sufficient space to access the power supply cord(s), because they serve as the product's main power disconnect.

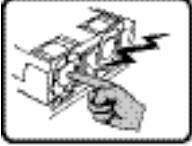
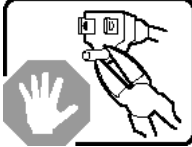
Deutsch

	<p>Benutzer können am Netzgerät dieses Produkts keine Reparaturen vornehmen. Das Produkt enthält möglicherweise mehrere Netzgeräte. Wartungsarbeiten müssen von qualifizierten Technikern ausgeführt werden.</p>
	<p>Versuchen Sie nicht, das mitgelieferte Netzkabel zu ändern oder zu verwenden, wenn es sich nicht genau um den erforderlichen Typ handelt. Ein Produkt mit mehreren Netzgeräten hat für jedes Netzgerät ein eigenes Netzkabel.</p>
	<p>Der Wechselstrom des Systems wird durch den Ein-/Aus-Schalter für Gleichstrom nicht ausgeschaltet. Ziehen Sie jedes Wechselstrom-Netzkabel aus der Steckdose bzw. dem Netzgerät, um den Stromanschluß des Systems zu unterbrechen.</p>
	<p>SICHERHEISSMASSNAHMEN: Immer wenn Sie die Gehäuseabdeckung abnehmen um an das Systeminnere zu gelangen, sollten Sie folgende Schritte beachten:</p> <ol style="list-style-type: none">1. Schalten Sie alle an Ihr System angeschlossenen Peripheriegeräte aus.2. Schalten Sie das System mit dem Hauptschalter aus.3. Ziehen Sie den Stromanschlußstecker Ihres Systems aus der Steckdose.4. Auf der Rückseite des Systems beschriften und ziehen Sie alle Anschlußkabel von den I/O Anschlüssen oder Ports ab.5. Tragen Sie ein geerdetes Antistatik Gelenkband, um elektrostatische Ladungen (ESD) über blanke Metallstellen bei der Handhabung der Komponenten zu vermeiden.6. Schalten Sie das System niemals ohne ordnungsgemäß montiertes Gehäuse ein.

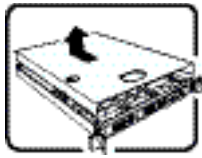

SICHERHEISSMASSNAHMEN: Immer wenn Sie die Gehäuseabdeckung abnehmen um an das Systeminnere zu gelangen, sollten Sie folgende Schritte beachten:

1. Schalten Sie alle an Ihr System angeschlossenen Peripheriegeräte aus.
2. Schalten Sie das System mit dem Hauptschalter aus.
3. Ziehen Sie den Stromanschlußstecker Ihres Systems aus der Steckdose.
4. Auf der Rückseite des Systems beschriften und ziehen Sie alle Anschlußkabel von den I/O Anschlüssen oder Ports ab.
5. Tragen Sie ein geerdetes Antistatik Gelenkband, um elektrostatische Ladungen (ESD) über blanke Metallstellen bei der Handhabung der Komponenten zu vermeiden.
6. Schalten Sie das System niemals ohne ordnungsgemäß montiertes Gehäuse ein.

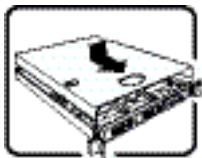

Zur ordnungsgemäßen Kühlung und Lüftung muß die Gehäuseabdeckung immer wieder vor dem Einschalten installiert werden. Ein Betrieb des Systems ohne angebrachte Abdeckung kann Ihrem System oder Teile darin beschädigen. Um die Abdeckung wieder anzubringen:

1. Vergewissern Sie sich, daß Sie keine Werkzeuge oder Teile im Innern des Systems zurückgelassen haben.
2. Überprüfen Sie alle Kabel, Zusatzkarten und andere Komponenten auf ordnungsgemäßen Sitz und Installation.
3. Bringen Sie die Abdeckungen wieder am Gehäuse an, indem Sie die zuvor gelösten Schrauben wieder anbringen. Ziehen Sie diese gut an.
4. Bringen Sie die Verschlusseinrichtung (Padlock) wieder an und schließen Sie diese, um ein unerlaubtes Öffnen des Systems zu verhindern.
5. Schließen Sie alle externen Kabel und den AC Stromanschlußstecker Ihres Systems wieder an.

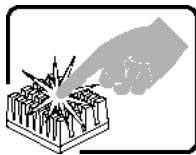

Der Mikroprozessor und der Kühler sind möglicherweise erhitzt, wenn das System in Betrieb ist. Außerdem können einige Platinen und Gehäuseteile scharfe Spitzen und Kanten aufweisen. Arbeiten an Platinen und Gehäuse sollten vorsichtig ausgeführt werden. Sie sollten Schutzhandschuhe tragen.

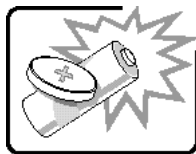

Bei falschem Einsetzen einer neuen Batterie besteht Explosionsgefahr. Die Batterie darf nur durch denselben oder einen entsprechenden, vom Hersteller empfohlenen Batterietyp ersetzt werden. Entsorgen Sie verbrauchte Batterien den Anweisungen des Herstellers entsprechend.

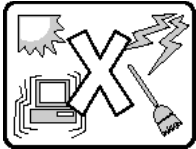
	<p>Das System wurde für den Betrieb in einer normalen Büroumgebung entwickelt. Der Standort sollte:</p> <ul style="list-style-type: none"> • "sauber und staubfrei sein (Hausstaub ausgenommen); • "gut gelüftet und keinen Heizquellen ausgesetzt sein (einschließlich direkter Sonneneinstrahlung); • "keinen Erschütterungen ausgesetzt sein; • "keine starken, von elektrischen Geräten erzeugten elektromagnetischen Felder aufweisen; • "in Regionen, in denen elektrische Stürme auftreten, mit einem Überspannungsschutzgerät verbunden sein; während eines elektrischen Sturms sollte keine Verbindung der Telekommunikationsleitungen mit dem Modem bestehen; • "mit einer geerdeten Wechselstromsteckdose ausgerüstet sein; • "über ausreichend Platz verfügen, um Zugang zu den Netzkabeln zu gewährleisten, da der Stromanschluß des Produkts hauptsächlich über die Kabel unterbrochen wird
-----------------------------------------------------------------------------------	--------------------------------------------------------------------------------------------------------------------------------------------------------------------------------------------------------------------------------------------------------------------------------------------------------------------------------------------------------------------------------------------------------------------------------------------------------------------------------------------------------------------------------------------------------------------------------------------------------------------------------------------------------------------------------------------------------------------------------------------------------------------------------------------------------------------------------------------------------------------------------------------------------------------------------------------------------------------------------

Français

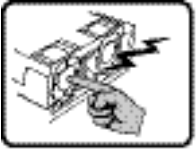
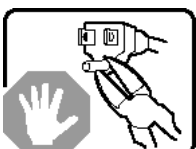
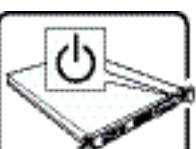
	<p>Le bloc d'alimentation de ce produit ne contient aucune pièce pouvant être réparée par l'utilisateur. Ce produit peut contenir plus d'un bloc d'alimentation. Veuillez contacter un technicien qualifié en cas de problème.</p>
	<p>Ne pas essayer d'utiliser ni modifier le câble d'alimentation CA fourni, s'il ne correspond pas exactement au type requis. Le nombre de câbles d'alimentation CA fournis correspond au nombre de blocs d'alimentation du produit</p>
	<p>Notez que le commutateur CC de mise sous tension /hors tension du panneau avant n'éteint pas l'alimentation CA du système. Pour mettre le système hors tension, vous devez débrancher chaque câble d'alimentation de sa prise.</p>

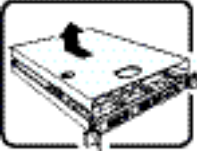
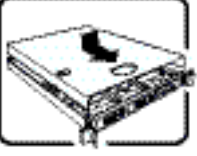
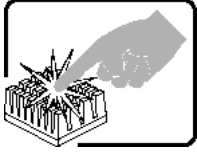
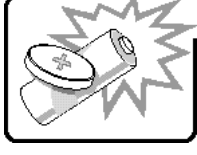
	<p>CONSIGNES DE SÉCURITÉ -Lorsque vous ouvrez le boîtier pour accéder à l'intérieur du système, suivez les consignes suivantes:</p> <ol style="list-style-type: none"> 1. Mettez hors tension tous les périphériques connectés au système. 2. Mettez le système hors tension en mettant l'interrupteur général en position OFF (bouton-poussoir). 3. Débranchez tous les cordons d'alimentation c.a. du système et des prises murales. 4. Identifiez et débranchez tous les câbles reliés aux connecteurs d'E-S ou aux accès derrière le système. 5. Pour prévenir les décharges électrostatiques lorsque vous touchez aux composants, portez une bande antistatique pour poignet et reliez-la à la masse du système (toute surface métallique non peinte du boîtier). 6. Ne faites pas fonctionner le système tandis que le boîtier est ouvert.
	<p>Une fois TOUTES les étapes précédentes accomplies, vous pouvez retirer les panneaux du système. Procédez comme suit:</p> <ol style="list-style-type: none"> 1. Si un cadenas a été installé sur à l'arrière du système, déverrouillez-le et retirez-le. 2. Retirez toutes les vis des panneaux et mettez-les dans un endroit sûr. 3. Retirez les panneaux.
	<p>Afin de permettre le refroidissement et l'aération du système, réinstallez toujours les panneaux du boîtier avant de mettre le système sous tension. Le fonctionnement du système en l'absence des panneaux risque d'endommager ses pièces. Pour installer les panneaux, procédez comme suit:</p> <ol style="list-style-type: none"> 1. Assurez-vous de ne pas avoir oublié d'outils ou de pièces démontées dans le système. 2. Assurez-vous que les câbles, les cartes d'extension et les autres composants sont bien installés. 3. Revissez solidement les panneaux du boîtier avec les vis retirées plus tôt. 4. Remettez le cadenas en place et verrouillez-le afin de prévenir tout accès non autorisé à l'intérieur du système. 5. Rebranchez tous les cordons d'alimentation c. a. et câbles externes au système.
	<p>Le microprocesseur et le dissipateur de chaleur peuvent être chauds si le système a été sous tension. Faites également attention aux broches aiguës des cartes et aux bords tranchants du capot. Nous vous recommandons l'usage de gants de protection.</p>
	<p>Danger d'explosion si la batterie n'est pas remontée correctement. Remplacer uniquement avec une batterie du même type ou d'un type équivalent recommandé par le fabricant. Disposez des piles usées selon les instructions du fabricant.</p>

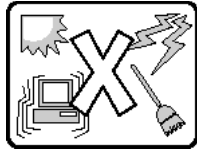

Le système a été conçu pour fonctionner dans un cadre de travail normal. L'emplacement choisi doit être:

- "Propre et dépourvu de poussière en suspension (sauf la poussière normale).
- "Bien aéré et loin des sources de chaleur, y compris du soleil direct.
- "A l'abri des chocs et des sources de vibrations.
- "Isolé de forts champs électromagnétiques générés par des appareils électriques.
- "Dans les régions sujettes aux orages magnétiques il est recommandé de brancher votre système à un supresseur de surtension, et de débrancher toutes les lignes de télécommunications de votre modem durant un orage.
- "Muni d'une prise murale correctement mise à la terre.
- "Suffisamment spacieux pour vous permettre d'accéder aux câbles d'alimentation (ceux-ci étant le seul moyen de mettre le système hors tension).

Español

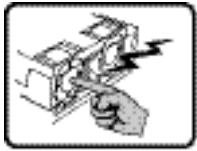

El usuario debe abstenerse de manipular los componentes de la fuente de alimentación de este producto, cuya reparación debe dejarse exclusivamente en manos de personal técnico especializado. Puede que este producto disponga de más de una fuente de alimentación

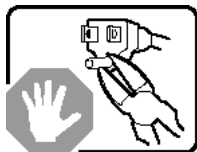

No intente modificar ni usar el cable de alimentación de corriente alterna, si no corresponde exactamente con el tipo requerido.
El número de cables suministrados se corresponden con el número de fuentes de alimentación de corriente alterna que tenga el producto

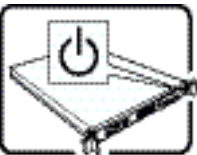



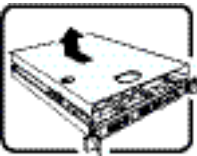
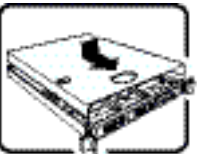
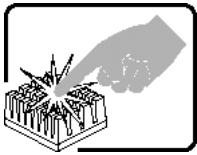

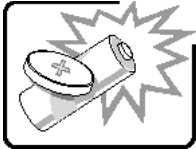
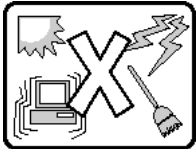
Nótese que el interruptor activado/desactivado en el panel frontal no desconecta la corriente alterna del sistema. Para desconectarla, deberá desenchufar todos los cables de corriente alterna de la pared o desconectar la fuente de alimentación.

	<p>INSTRUCCIONES DE SEGURIDAD: Cuando extraiga la tapa del chasis para acceder al interior del sistema, siga las siguientes instrucciones:</p> <ol style="list-style-type: none"> 1. Apague todos los dispositivos periféricos conectados al sistema. 2. Apague el sistema presionando el interruptor encendido/apagado. 3. Desconecte todos los cables de alimentación CA del sistema o de las tomas de corriente alterna. 4. Identifique y desconecte todos los cables enchufados a los conectores E/S o a los puertos situados en la parte posterior del sistema. 5. Cuando manipule los componentes, es importante protegerse contra la descarga electrostática (ESD). Puede hacerlo si utiliza una muñequera antiestática sujeta a la toma de tierra del chasis - o a cualquier tipo de superficie de metal sin pintar. 6. No ponga en marcha el sistema si se han extraído las tapas del chasis.
	<p>Después de completar las seis instrucciones de SEGURIDAD mencionadas, ya puede extraer las tapas del sistema. Para ello:</p> <ol style="list-style-type: none"> 1. Desbloquee y extraiga el bloqueo de seguridad de la parte posterior del sistema, si se ha instalado uno. 2. Extraiga y guarde todos los tornillos de las tapas. Extraiga las tapas.
	<p>Para obtener un enfriamiento y un flujo de aire adecuados, reinstale siempre las tapas del chasis antes de poner en marcha el sistema. Si pone en funcionamiento el sistema sin las tapas bien colocadas puede dañar los componentes del sistema. Para instalar las tapas:</p> <ol style="list-style-type: none"> 1. Asegúrese primero de no haber dejado herramientas o componentes sueltos dentro del sistema. 2. Compruebe que los cables, las placas adicionales y otros componentes se hayan instalado correctamente. 3. Incorpore las tapas al chasis mediante los tornillos extraídos anteriormente, tensándolos firmemente. 4. Inserte el bloqueo de seguridad en el sistema y bloquéelo para impedir que pueda accederse al mismo sin autorización. 5. Conecte todos los cables externos y los cables de alimentación CA al sistema.
	<p>Si el sistema ha estado en funcionamiento, el microprocesador y el disipador de calor pueden estar aún calientes. También conviene tener en cuenta que en el chasis o en el tablero puede haber piezas cortantes o punzantes. Por ello, se recomienda precaución y el uso de guantes protectores.</p>

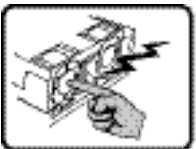
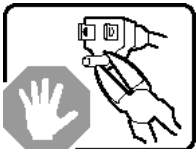
	<p>Existe peligro de explosión si la pila no se cambia de forma adecuada. Utilice solamente pilas iguales o del mismo tipo que las recomendadas por el fabricante del equipo. Para deshacerse de las pilas usadas, siga igualmente las instrucciones del fabricante.</p>
	<p>El sistema está diseñado para funcionar en un entorno de trabajo normal. Escoja un lugar:</p> <ul style="list-style-type: none"> • "Limpio y libre de partículas en suspensión (salvo el polvo normal). • "Bien ventilado y alejado de fuentes de calor, incluida la luz solar directa. • "Alejado de fuentes de vibración. • "Aislado de campos electromagnéticos fuertes producidos por dispositivos eléctricos. • "En regiones con frecuentes tormentas eléctricas, se recomienda conectar su sistema a un eliminador de sobrevoltage y desconectar el módem de las líneas de telecomunicación durante las tormentas. • "Provisto de una toma de tierra correctamente instalada. • "Provisto de espacio suficiente como para acceder a los cables de alimentación, ya que éstos hacen de medio principal de desconexión del sistema.

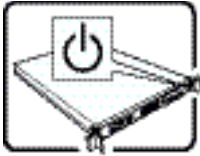
Italiano

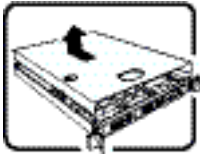
	<p>Rivolgersi ad un tecnico specializzato per la riparazione dei componenti dell'alimentazione di questo prodotto. È possibile che il prodotto disponga di più fonti di alimentazione.</p>
	<p>Non modificare o utilizzare il cavo di alimentazione in c.a. fornito dal produttore, se non corrisponde esattamente al tipo richiesto. Ad ogni fonte di alimentazione corrisponde un cavo di alimentazione in c.a. separato</p>

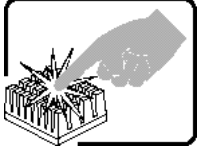
	<p>L'interruttore attivato/disattivato nel pannello anteriore non interrompe l'alimentazione in c.a. del sistema. Per interromperla, è necessario scollegare tutti i cavi di alimentazione in c.a. dalle prese a muro o dall'alimentazione di corrente.</p>
	<p>PASSI DI SICUREZZA: Qualora si rimuovano le coperture del telaio per accedere all'interno del sistema, seguire i seguenti passi:</p> <ol style="list-style-type: none"> 1. Spegner tutti i dispositivi periferici collegati al sistema. 2. Spegner il sistema, usando il pulsante spento/acceso dell'interruttore del sistema. 3. Togliere tutte le spine dei cavi del sistema dalle prese elettriche. 4. Identificare e sconnettere tutti i cavi attaccati ai collegamenti I/O od alle prese installate sul retro del sistema. 5. Qualora si tocchino i componenti, proteggersi dallo scarico elettrostatico (SES), portando un cinghia anti-statica da polso che è attaccata alla presa a terra del telaio del sistema - qualsiasi superficie non dipinta - . 6. Non far operare il sistema quando il telaio è senza le coperture.
	<p>Dopo aver seguito i sei passi di SICUREZZA sopracitati, togliere le coperture del telaio del sistema come segue:</p> <ol style="list-style-type: none"> 1. Aprire e rimuovere il lucchetto dal retro del sistema qualora ve ne fosse uno installato. 2. Togliere e mettere in un posto sicuro tutte le viti delle coperture. 3. Togliere le coperture.
	<p>Per il giusto flusso dell'aria e raffreddamento del sistema, rimettere sempre le coperture del telaio prima di riaccendere il sistema. Operare il sistema senza le coperture al loro proprio posto potrebbe danneggiare i componenti del sistema. Per rimettere le coperture del telaio:</p> <ol style="list-style-type: none"> 1. Controllare prima che non si siano lasciati degli attrezzi o dei componenti dentro il sistema. 2. Controllare che i cavi, dei supporti aggiuntivi ed altri componenti siano stati installati appropriatamente. 3. Attaccare le coperture al telaio con le viti tolte in precedenza e avvitarle strettamente. 4. Inserire e chiudere a chiave il lucchetto sul retro del sistema per impedire l'accesso non autorizzato al sistema. 5. Ricollegare tutti i cavi esterni e le prolunghie AC del sistema.
	<p>Se il sistema è stato a lungo in funzione, il microprocessore e il dissipatore di calore potrebbero essere surriscaldati. Fare attenzione alla presenza di piedini appuntiti e parti taglienti sulle schede e sul telaio. È consigliabile l'uso di guanti di protezione.</p>

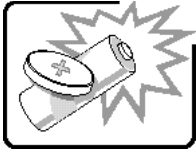
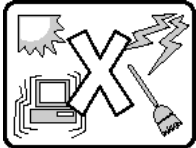
	<p>Esiste il pericolo di un'esplosione se la pila non viene sostituita in modo corretto. Utilizzare solo pile uguali o di tipo equivalente a quelle consigliate dal produttore. Per disfarsi delle pile usate, seguire le istruzioni del produttore.</p>
	<p>Il sistema è progettato per funzionare in un ambiente di lavoro tipo. Scegliere una postazione che sia:</p> <ul style="list-style-type: none"> • "Pulita e libera da particelle in sospensione (a parte la normale polvere presente nell'ambiente). • "Ben ventilata e lontana da fonti di calore, compresa la luce solare diretta. • "Al riparo da urti e lontana da fonti di vibrazione. • "Isolata dai forti campi magnetici prodotti da dispositivi elettrici. • "In aree soggette a temporali, è consigliabile collegare il sistema ad un limitatore di corrente. In caso di temporali, scollegare le linee di comunicazione dal modem. • "Dotata di una presa a muro correttamente installata. • "Dotata di spazio sufficiente ad accedere ai cavi di alimentazione, i quali rappresentano il mezzo principale di scollegamento del sistema.

Appendix E: Safety Information

Warning Labels

The Intel® Server System SR9000MK4U contains several warning labels on the interior and exterior of the server system. These warning labels indicate components that present a potential danger. Do not remove these warning labels. The following diagrams show the labels and their locations.

A label inside each memory box warns you that the components may be hot. Allow the memory box to cool for at least 10 minutes before attempting to touch any components on it.

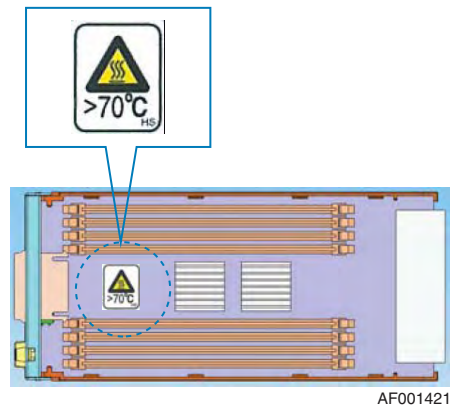

Figure 140. Caution: Memory Box Contains Hot Components

A warning on the side of the chassis warns you that the chassis is heavy. Do not attempt to lift the server system alone. If handles are installed, at least two people should lift the system by grasping the handles. If the handles are not installed, at least two people should lift the handle by holding the underside of the system.

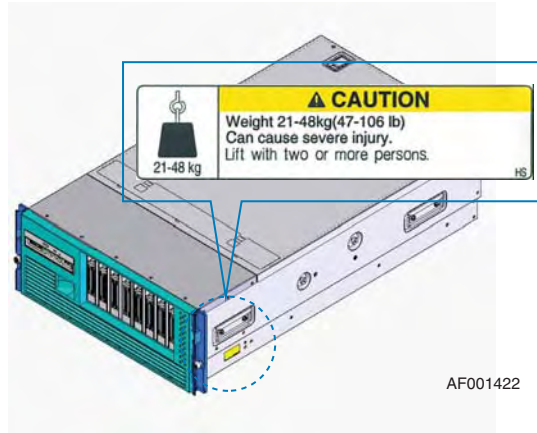

Figure 141. Caution: Server System is Heavy

The warnings labels at the rear of the server chassis contains voltage information.

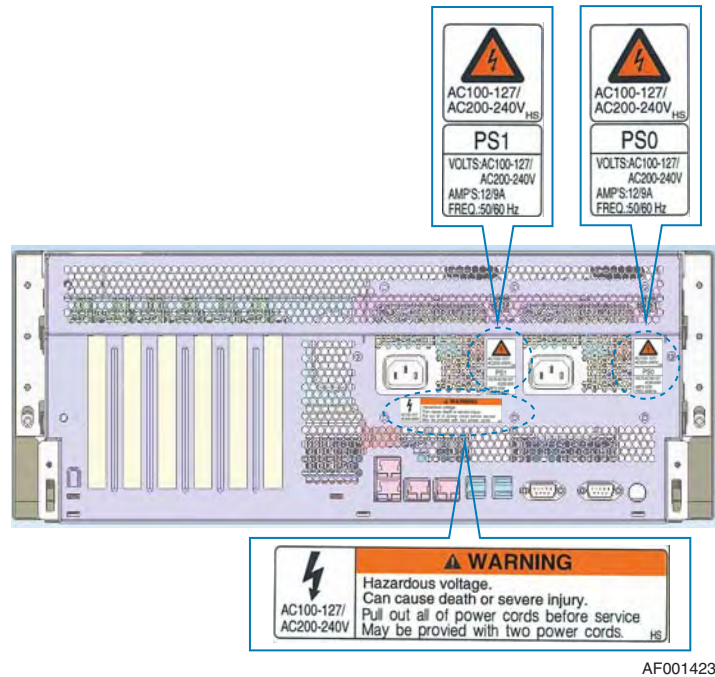
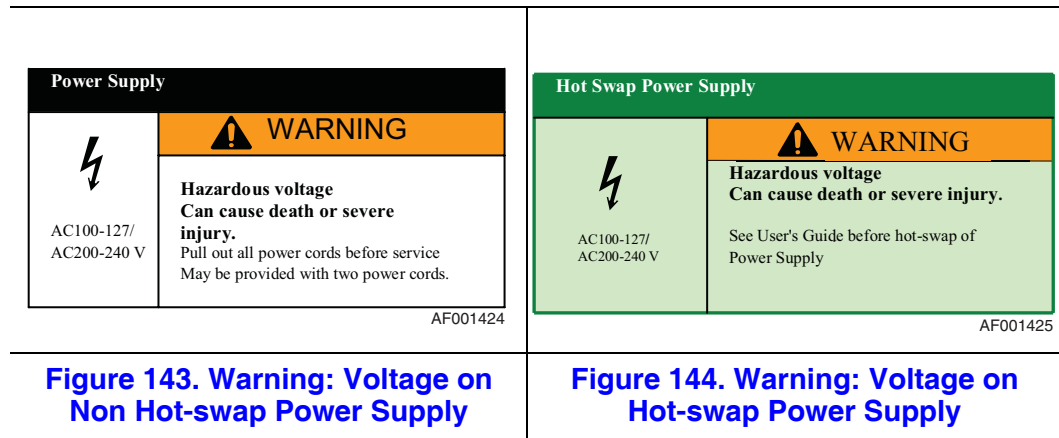

Figure 142. Caution: System Contains Areas of High Voltage

One of the following labels will be attached to your power supply.



English

Server Safety Information

This document applies to Intel[®] server boards, Intel[®] server chassis (pedestal and rack-mount) and installed peripherals. To reduce the risk of bodily injury, electrical shock, fire, and equipment damage, read this document and observe all warnings and precautions in this guide before installing or maintaining your Intel[®] server product.







In the event of a conflict between the information in this document and information provided with the product or on the website for a particular product, the product documentation takes precedence.

Your server should be integrated and serviced only by technically qualified persons.

You must adhere to the guidelines in this guide and the assembly instructions in your server manuals to ensure and maintain compliance with existing product certifications and approvals. Use only the described, regulated components specified in this guide. Use of other products / components will void the UL Listing and other regulatory approvals of the product, and may result in noncompliance with product regulations in the region(s) in which the product is sold.

Safety Warnings and Cautions

To avoid personal injury or property damage, before you begin installing the product, read, observe, and adhere to all of the following safety instructions and information. The following safety symbols may be used throughout the documentation and may be marked on the product and / or the product packaging.

CAUTION	Indicates the presence of a hazard that may cause minor personal injury or property damage if the CAUTION is ignored.
WARNING	Indicates the presence of a hazard that may result in serious personal injury if the WARNING is ignored.
	Indicates potential hazard if indicated information is ignored.
	Indicates shock hazards that result in serious injury or death if safety instructions are not followed.
	Indicates hot components or surfaces.
	Indicates do not touch fan blades, may result in injury.
	Indicates to unplug all AC power cord(s) to disconnect AC power
	Please recycle battery

Intended Application Uses

This product was evaluated as Information Technology Equipment (ITE), which may be installed in offices, schools, computer rooms, and similar commercial type locations. The suitability of this product for other product categories and environments (such as medical, industrial, residential, alarm systems, and test equipment), other than an ITE application, may require further evaluation.

Site Selection

The system is designed to operate in a typical office environment. Choose a site that is:

- Clean, dry, and free of airborne particles (other than normal room dust).
- Well-ventilated and away from sources of heat including direct sunlight and radiators.
- Away from sources of vibration or physical shock.
- Isolated from strong electromagnetic fields produced by electrical devices.
- In regions that are susceptible to electrical storms, we recommend you plug your system into a surge suppressor and disconnect telecommunication lines to your modem during an electrical storm.
- Provided with a properly grounded wall outlet.
- Provided with sufficient space to access the power supply cord(s), because they serve as the product's main power disconnect.

Equipment Handling Practices

Reduce the risk of personal injury or equipment damage:

- Conform to local occupational health and safety requirements when moving and lifting equipment.
- Use mechanical assistance or other suitable assistance when moving and lifting equipment.
- To reduce the weight for easier handling, remove any easily detachable components.

Power and Electrical Warnings

Cautions:

- *The power button, indicated by the stand-by power marking, DOES NOT completely turn off the system AC power, 5V standby power is active whenever the system is plugged in. To remove power from system, you must unplug the AC power cord from the wall outlet. Your system may use more than one AC power cord. Make sure all AC power cords are unplugged. Make sure the AC power cord(s) is/are unplugged before you open the chassis, or add or remove any non hot-plug components.*
- *Do not attempt to modify or use an AC power cord if it is not the exact type required. A separate AC cord is required for each system power supply.*
- *Some power supplies in Intel® servers use Neutral Pole Fusing. To avoid risk of shock use caution when working with power supplies that use Neutral Pole Fusing.*
- *The power supply in this product contains no user-serviceable parts. Do not open the power supply. Hazardous voltage, current and energy levels are present inside the power supply. Return to manufacturer for servicing.*
- *When replacing a hot-plug power supply, unplug the power cord to the power supply being replaced before removing it from the server.*
- *To avoid risk of electric shock, turn off the server and disconnect the power cord, telecommunications systems, networks, and modems attached to the server before opening it.*

Power Cord Warnings

If an AC power cord was not provided with your product, purchase one that is approved for use in your country.

Caution: *To avoid electrical shock or fire, check the power cord(s) that will be used with the product as follows:*

- *Do not attempt to modify or use the AC power cord(s) if they are not the exact type required to fit into the grounded electrical outlets*
- *The power cord(s) must meet the following criteria:*
- *The power cord must have an electrical rating that is greater than that of the electrical current rating marked on the product.*
- *The power cord must have safety ground pin or contact that is suitable for the electrical outlet.*
- *The power supply cord(s) is/are the main disconnect device to AC power. The socket outlet(s) must be near the equipment and readily accessible for disconnection.*
- *The power supply cord(s) must be plugged into socket-outlet(s) that is /are provided with a suitable earth ground.*

System Access Warnings

Caution: To avoid personal injury or property damage, the following safety instructions apply whenever accessing the inside of the product:

- Turn off all peripheral devices connected to this product.
- Turn off the system by pressing the power button to off.
- Disconnect the AC power by unplugging all AC power cords from the system or wall outlet.
- Disconnect all cables and telecommunication lines that are connected to the system.
- Retain all screws or other fasteners when removing access cover(s). Upon completion of accessing inside the product, refasten access cover with original screws or fasteners.
- Do not access the inside of the power supply. There are no serviceable parts in the power supply. Return to manufacturer for servicing.
- Power down the server and disconnect all power cords before adding or replacing any non hot-plug component.
- When replacing a hot-plug power supply, unplug the power cord to the power supply being replaced before removing the power supply from the server.

Caution: If the server has been running, any installed processor(s) and heat sink(s) may be hot. Unless you are adding or removing a hot-plug component, allow the system to cool before opening the covers. To avoid the possibility of coming into contact with hot component(s) during a hot-plug installation, be careful when removing or installing the hot-plug component(s).

Caution: To avoid injury do not contact moving fan blades. If your system is supplied with a guard over the fan, do not operate the system without the fan guard in place.

Rack Mount Warnings

The equipment rack must be anchored to an unmovable support to prevent it from tipping when a server or piece of equipment is extended from it. The equipment rack must be installed according to the rack manufacturer's instructions.

Install equipment in the rack from the bottom up, with the heaviest equipment at the bottom of the rack.

Extend only one piece of equipment from the rack at a time.

You are responsible for installing a main power disconnect for the entire rack unit. This main disconnect must be readily accessible, and it must be labeled as controlling power to the entire unit, not just to the server(s).

To avoid risk of potential electric shock, a proper safety ground must be implemented for the rack and each piece of equipment installed in it.

Elevated Operating Ambient - If installed in a closed or multi-unit rack assembly, the operating ambient temperature of the rack environment may be greater than room ambient. Therefore, consideration should be given to installing the equipment in an environment compatible with the maximum ambient temperature (T_{ma}) specified by the manufacturer.

Reduced Air Flow - Installation of the equipment in a rack should be such that the amount of air flow required for safe operation of the equipment is not compromised.

Mechanical Loading - Mounting of the equipment in the rack should be such that a hazardous condition is not achieved due to uneven mechanical loading.

Circuit Overloading - Consideration should be given to the connection of the equipment to the supply circuit and the effect that overloading of the circuits might have on overcurrent protection and supply wiring. Appropriate consideration of equipment nameplate ratings should be used when addressing this concern.

Reliable Earthing - Reliable earthing of rack-mounted equipment should be maintained. Particular attention should be given to supply connections other than direct connections to the branch circuit (e.g. use of power strips).

Electrostatic Discharge (ESD)

Caution: *ESD can damage disk drives, boards, and other parts. We recommend that you perform all procedures at an ESD workstation. If one is not available, provide some ESD protection by wearing an antistatic wrist strap attached to chassis ground -- any unpainted metal surface -- on your server when handling parts.*

Always handle boards carefully. They can be extremely sensitive to ESD. Hold boards only by their edges. After removing a board from its protective wrapper or from the server, place the board component side up on a grounded, static free surface. Use a conductive foam pad if available but not the board wrapper. Do not slide board over any surface.

Other Hazards

Battery Replacement

Caution: *There is the danger of explosion if the battery is incorrectly replaced. When replacing the battery, use only the battery recommended by the equipment manufacturer.*

Dispose of batteries according to local ordinances and regulations.

Do not attempt to recharge a battery.

Do not attempt to disassemble, puncture, or otherwise damage a battery.

Cooling and Airflow

Caution: *Carefully route cables as directed to minimize airflow blockage and cooling problems.*

For proper cooling and airflow, operate the system only with the chassis covers installed. Operating the system without the covers in place can damage system parts. To install the covers:

- *Check first to make sure you have not left loose tools or parts inside the system.*
- *Check that cables, add-in boards, and other components are properly installed.*
- *Attach the covers to the chassis according to the product instructions.*

Laser Peripherals or Devices

Caution: *To avoid risk of radiation exposure and/or personal injury:*

- *Do not open the enclosure of any laser peripheral or device*
- *Laser peripherals or devices have are not user serviceable*
- *Return to manufacturer for servicing*

Deutsch

Sicherheitshinweise für den Server

Das vorliegende Dokument bezieht sich auf Intel® Serverplatinen, Intel® Servergehäuse (Standfuß und Rack) sowie installierte Peripheriegeräte. Es enthält Warnungen und Vorsichtsmaßnahmen zur Vermeidung von Gefahren durch Verletzung, Stromschlag, Feuer und Beschädigungen von Geräten. Lesen Sie diese Dokument daher sorgfältig, bevor Sie Ihr Intel® Serverprodukt installieren oder warten.



Bei Widersprüchen zwischen den hier vorliegenden Angaben und den Informationen im Lieferumfang des Produkts oder auf der Website des betreffenden Produkts hat die Produktdokumentation Vorrang.



Die Integration und Wartung des Servers darf nur durch technisch qualifizierte Personen erfolgen.

Um die Einhaltung der vorhandenen Zulassungen und Genehmigungen für das Produkt zu gewährleisten, sind die Richtlinien in diesem Handbuch sowie die Montageanleitungen in den Serverhandbüchern zu beachten. Verwenden Sie nur die beschriebenen, zugelassenen Komponenten, die im vorliegenden Handbuch angegeben werden. Die Verwendung anderer Produkte oder Komponenten führt zum Erlöschen der UL-Zulassung und anderer Genehmigungen für das Produkt. Dadurch kann das Produkt gegen Produktbestimmungen verstoßen, die im Verkaufsland gelten.

Sicherheitshinweise und Vorsichtsmaßnahmen

Um Verletzungen und Beschädigungen zu vermeiden, sollten Sie vor dem Beginn der Produktinstallation die nachfolgend aufgeführten Sicherheitshinweise und -informationen sorgfältig lesen und befolgen. In dem vorliegenden Handbuch sowie auf dem Produkt und auf der Verpackung werden folgende Sicherheitssymbole verwendet:

VORSICHT	Weist auf eine Gefahrenquelle hin, die bei Nichtbeachtung des VORSICHTSHINWEISES zu leichteren Verletzungen bzw. Sachbeschädigungen führen kann.
WARNUNG	Weist auf eine Gefahrenquelle hin, die bei Nichtbeachtung der WARNUNG zu ernstesten Verletzungen führen kann.
	Weist auf potentielle Gefahr bei Nichtbeachtung der angezeigten Informationen hin.
	Weist auf die Gefahr eines Stromschlags hin, der bei Nichtbeachtung der Sicherheitshinweise zu schweren oder tödlichen Verletzungen führen kann.
	Weist auf Verbrennungsgefahr an heißen Bauteilen bzw. Oberflächen hin.

	Weist darauf hin, daß das Anfassen des Gebläses zu Verletzungen führen kann.
	Bedeutet, alle Netzkabel abzuziehen und das Gerät von der Netzspannung zu trennen.
	Bereiten Sie bitte Batterie auf

Zielbenutzer der Anwendung

Dieses Produkt wurde in seiner Eigenschaft als IT-Gerät getestet, das in Büros, Schulen, Computerräumen und ähnlichen öffentlichen Räumlichkeiten installiert werden kann. Die Eignung dieses Produkts für andere Einsatzbereiche als IT (z. B. Medizin, Industrie, Alarmsysteme oder Prüfgeräte) kann u. U. weitere Tests erfordern.

Standortauswahl

Das System ist für den Betrieb innerhalb normaler Büroumgebungen geeignet. Wählen Sie einen Standort, der folgenden Kriterien entspricht:

- Sauber, trocken und frei von Partikeln in der Luft (außer dem normalen Raumstaub).
- Gut belüftet, nicht in der Nähe von Wärmequellen und keiner direkten Sonnenbestrahlung ausgesetzt.
- Nicht in der Nähe von Vibrations oder Erschütterungsquellen.
- Abgeschirmt von starken elektromagnetischen Feldern, die durch elektrische Geräte erzeugt werden.
- In gewittergefährdeten Gebieten sollten Sie das System an einen Überspannungsschutz anschließen und bei einem Gewitter die Telekommunikationskabel zum Modem abziehen.
- Eine ordnungsgemäß geerdete Wandsteckdose muß vorhanden sein.
- Ausreichender Freiraum für den Zugang zu den Netzkabeln, da diese die Hauptvorrichtung zum Trennen des Produkts von der Stromversorgung sind.

Handhabung von Geräten

Beachten Sie zur Vermeidung von Verletzungen oder Beschädigungen an den Geräten die folgenden Hinweise:

- Halten Sie beim Transportieren und Anheben von Geräten die örtlichen Gesundheits- und Sicherheitsvorschriften ein.
- Verwenden Sie mechanische oder andere geeignete Hilfsmittel zum Transportieren oder Anheben von Geräten.
- Entfernen Sie alle Komponenten, die sich leicht abnehmen lassen, um das Gewicht zu reduzieren und die Handhabung zu erleichtern.

Warnungen zu Netzspannung und Elektrizität

Vorsicht: *Durch Betätigen der mit dem Standby-Symbol gekennzeichneten Netztaste wird das System NICHT vollständig vom Netz getrennt. Es sind weiterhin 5 V aktiv, solange das System eingesteckt ist. Um das System vollständig vom Strom zu trennen, muß das Netzkabel aus der Steckdose abgezogen werden. Das System verfügt möglicherweise über mehrere Netzkabel. Vergewissern Sie sich in diesem Fall, daß alle Netzkabel abgezogen sind. Wenn Sie Komponenten ein- oder ausbauen möchten, die nicht hot-plug-fähig sind, stellen Sie sicher, daß zuvor alle Netzkabel abgezogen sind.*

Nehmen Sie keine Änderungen am Netzkabel vor, und verwenden Sie kein Kabel, das nicht genau dem geforderten Typ entspricht. Jedes Netzteil im System muß über ein eigenes Netzkabel angeschlossen werden.

Einige Netzteile von Intel Servern verwenden Nullleitersicherungen. Vorsicht ist geboten im Umgang mit Netzteilen, welche Nullleitersicherungen verwenden, um das Risiko eines elektrischen Schlages zu vermeiden

Das Netzteil in diesem Produkt enthält keine Teile, die vom Benutzer gewartet werden können. Öffnen Sie das Netzteil nicht. Im Netzteil bestehen gefährliche Spannungen, Ströme und Energiequellen. Schicken Sie das Gerät für Wartungsarbeiten an den Hersteller zurück.

Wenn Sie ein hot-plug-fähiges Netzteil austauschen, ziehen Sie dessen Netzkabel ab, bevor Sie es aus dem Server ausbauen.

Zur Vermeidung von Stromschlägen schalten Sie den Server aus, und trennen Sie vor dem Öffnen des Geräts das Netzkabel sowie alle an den Server angeschlossene Telekommunikationssysteme, Netzwerke und Modems.

Hinweis für Netzkabel

Wenn kein Netzkabel mit dem Produkt geliefert wurde, kaufen Sie ein Kabel, das für die

Vorsicht: Prüfen Sie zur Vermeidung von Stromschlag- oder Feuergefahr die mit dem Produkt zu verwendenden Netzkabel wie folgt:

- Nehmen Sie keine Änderungen an einem Netzkabel vor, und benutzen sie es nicht, wenn es nicht genau in die geerdeten Netzsteckdosen paßt.
- Netzkabel müssen die folgenden Anforderungen erfüllen:
- Die Nennbelastbarkeit des Netzkabels muß mindestens so hoch sein wie die am Produkt angegebenen Nennstromaufnahme.
- Das Netzkabel muß einen zur Netzsteckdose passenden Schutzkontakt besitzen.
- Die Netzkabel sind die Hauptvorrichtung zum Trennen des Geräts vom Stromnetz. Die Steckdose muß in der Nähe der Anlage angebracht und gut erreichbar sein.
- Netzkabel müssen an eine ordnungsgemäß geerdete Steckdose angeschlossen sein.

Warnhinweise für den Systemzugang

Vorsicht: Um Verletzungen und Beschädigungen zu vermeiden, sollten Sie vor Arbeiten im Produktinneren folgende Sicherheitsanweisungen beachten:

- Schalten Sie alle am Produkt angeschlossenen Peripheriegeräte aus.
- Schalten Sie das System mit dem Netzschalter aus.
- Trennen Sie das Gerät von der Stromquelle, indem Sie alle Netzkabel vom System bzw. aus der Steckdose ziehen.
- Ziehen Sie alle Kabel und alle an das System angeschlossenen Telekommunikationsleitungen ab.
- Bewahren Sie alle Schrauben und anderen Befestigungselemente gut auf, nachdem Sie die Gehäuseabdeckung entfernt haben. Wenn Sie Ihre Arbeiten im Systeminneren beendet haben, befestigen Sie die Gehäuseabdeckung mit den Originalschrauben bzw. -befestigungselementen.
- Führen Sie keine Arbeiten im Netzteil aus. Das Netzteil enthält keine für den Benutzer wartungsbedürftigen Teile. Schicken Sie das Gerät für Wartungsarbeiten an den Hersteller zurück.
- Schalten Sie den Server aus, und ziehen Sie alle Netzkabel ab, bevor Sie Komponenten ein- oder ausbauen, die nicht hot-plug-fähig sind.
- Wenn Sie ein hot-plug-fähiges Netzteil austauschen, ziehen Sie dessen Netzkabel ab, bevor Sie es aus dem Server ausbauen.

Vorsicht: War Ihr Server in Betrieb, können die installierten Prozessoren und Kühlkörper heiß sein. Sofern Sie keine Hot-Plug-Komponenten ein- oder ausbauen, warten Sie mit dem Abnehmen der Abdeckungen, bis das System abgekühlt ist. Gehen Sie beim Aus- oder

Einbauen von Hot-Plug-Komponenten sorgfältig vor, um nicht mit heißen Komponenten in Berührung zu kommen.

Vorsicht: *Berühren Sie nicht die rotierenden Lüfterflügel, um Verletzungen zu vermeiden. Falls Ihr System mit einer Lüfterabdeckung besitzt, darf es nicht ohne diese Abdeckung betrieben werden.*

Warnhinweise für Racks

Das Geräte-Rack muß auf einer geeigneten, festen Unterlage verankert werden, um ein Umkippen zu vermeiden, wenn ein Server oder andere Geräte herausgezogen werden. Bei der Installation des Racks müssen die Anweisungen des Rack-Herstellers beachtet werden.

Gehen Sie bei der Installation von Geräten im Rack immer von unten nach oben vor, und bauen Sie das schwerste Gerät an der untersten Position im Rack ein.

Ziehen Sie jeweils immer nur ein Gerät aus dem Rack heraus.

Sie müssen für die gesamte Rack-Einheit einen Netztrennschalter einrichten. Dieser Netztrennschalter muß leicht zugänglich sein und über eine Kennzeichnung verfügen, die besagt, daß er die Stromzufuhr zur gesamten Einheit steuert und nicht nur zu den Servern.

Zur Vermeidung von Stromschlaggefahr müssen das Rack selbst und alle darin eingebauten Geräte ordnungsgemäß geerdet sein.

Elektrostatische Entladungen (ESD)

Vorsicht: *Elektrostatische Entladungen können zur Beschädigung von Festplatten, Platinen und anderen Komponenten führen. Daher sollten Sie alle Arbeiten an einer ESD-Workstation ausführen. Steht ein solcher Arbeitsplatz nicht zur Verfügung, erzielen Sie einen gewissen Schutz vor elektrostatischen Entladungen durch Tragen einer Antistatik-Manschette, die Sie während der Arbeit zur Erdung an einem beliebigen unlackierten Metallteil des Computergehäuses befestigen.*

Gehen Sie bei der Handhabung von Platinen immer mit größter Vorsicht vor. Sie können äußerst empfindlich gegenüber elektrostatischer Entladung sein. Halten Sie Platinen nur an den Kanten fest. Legen Sie die Platinen nach dem Auspacken aus der Schutzhülle oder nach dem Ausbau aus dem Server mit der Bauelementseite nach oben auf eine geerdete, statisch entladene Unterlage. Verwenden Sie dazu, sofern verfügbar, eine leitfähige Schaumstoffunterlage, aber nicht die Schutzhülle der Platine. Ziehen Sie die Platine nicht über eine Fläche.

Andere Gefahren

Batterieaustausch

Vorsicht: Wird die Batterie unsachgemäß ausgetauscht, besteht Explosionsgefahr. Verwenden Sie als Ersatz nur die vom Gerätehersteller empfohlene Batterie.

Beachten Sie bei der Entsorgung von Batterien die gültigen Bestimmungen.

Versuchen Sie nicht, eine Batterie aufzuladen.

Versuchen Sie nicht, eine Batterie zu öffnen oder sonstwie zu beschädigen.

Kühlung und Luftstrom

Vorsicht: Verlegen Sie Kabel sorgfältig entsprechend der Anleitung, um Störungen des Luftstroms und Kühlungsprobleme zu vermeiden.

Zur Gewährleistung des ordnungsgemäßen Kühlungs- und Luftstromverhaltens darf das System nur mit angebrachten Gehäuseabdeckungen betrieben werden. Die Inbetriebnahme des Systems ohne Abdeckung kann zur Beschädigung von Systemkomponenten führen. So bringen Sie die Abdeckung wieder an:

- Vergewissern Sie sich zunächst, daß Sie keine Werkzeuge oder Teile im Gehäuse vergessen haben.
- Prüfen Sie, ob Kabel, Erweiterungskarten sowie weitere Komponenten ordnungsgemäß angebracht sind.
- Befestigen Sie die Abdeckungen am Gehäuse des Produkts, wie in dessen Anleitung beschrieben.

Laser-Peripheriegeräte oder -Komponenten

Vorsicht: Beachten Sie zur Vermeidung von Strahlung und Verletzungen die folgenden Hinweise:

- Öffnen Sie keinesfalls das Gehäuse von Laser-Peripheriegeräten oder Laser-Komponenten.
- Laser-Peripheriegeräte oder -Komponenten besitzen keine für den Benutzer wartungsbedürftigen Teile.
- Schicken Sie das Gerät für Wartungsarbeiten an den Hersteller zurück.

Français

Consignes de sécurité sur le serveur

Ce document s'applique aux cartes serveur Intel®, au châssis de serveur Intel® (sur pieds et sur rack) et aux périphériques installés. Pour réduire les risques de dommages corporels, d'électrocution, d'incendie et de dommages matériels, lisez ce document et respectez tous les avertissements et précautions mentionnés dans ce guide avant d'installer ou de mettre à jour votre produit serveur Intel®.





En cas de conflit entre les informations fournies dans ce document et celles livrées avec le produit ou publiées sur le site Web pour un produit particulier, la documentation du produit prime.

Votre serveur doit être intégré et entretenu uniquement par des techniciens qualifiés.

Vous devez suivre les informations de ce guide et les instructions d'assemblage des manuels de serveur pour vérifier et maintenir la conformité avec les certifications et approbations de produit existantes. Utilisez uniquement les composants décrits et réglementés spécifiés dans ce guide. L'utilisation d'autres produits/composants annulera la liste UL et les autres approbations réglementaires du produit, et le produit peut ne pas être conforme aux autres lois et réglementations locales applicables au produit.

Sécurité: avertissements et mises en garde

Pour éviter de vous blesser ou d'endommager votre équipement, lisez et respectez toutes les informations et consignes de sécurité avant de commencer l'installation du produit. Les symboles de sécurité suivants peuvent être utilisés tout au long de cette documentation et peuvent figurer sur le produit ou sur son emballage.

ATTENTION	Indique la présence d'un risque pouvant entraîner des blessures physiques mineures ou endommager légèrement le matériel si la mise en garde n'est pas prise en compte.
AVERTISSEMENT	Indique la présence d'un risque pouvant entraîner des blessures corporelles graves si l'avertissement n'est pas pris en compte.
	Indique un risque potentiel si les informations signalées ne sont pas prises en compte.
	Indique des risques d'électrocution pouvant entraîner des blessures corporelles graves ou mortelles si les consignes de sécurité ne sont pas respectées.
	Signale des composants ou des surfaces soumis à des températures élevées.
	Indique de ne pas toucher aux pales de ventilateur, car cela peut entraîner des blessures.



Indique de débrancher tous les cordons d'alimentation secteur pour déconnecter l'alimentation.



Veillez réutiliser la batterie

Domaines d'utilisation prévus

Ce produit a été testé comme équipement informatique (ITE) et peut être installé dans des bureaux, des écoles, des salles informatiques et des endroits commerciaux similaires. L'utilisation du présent produit dans des catégories et environnements de produits et domaines d'application (par exemple, le domaine médical, industriel, résidentiel, les systèmes d'alarme et les appareils de contrôle) autres qu'ITE doit faire l'objet d'évaluations supplémentaires.

Sélection d'un emplacement

Le système est conçu pour fonctionner dans un environnement standard de bureau. Choisissez un emplacement respectant les conditions suivantes :

- Propre, sec et exempt de particules en suspension (autres que la poussière normale d'une pièce).
- Bien ventilé et à l'écart des sources de chaleur telles que la lumière directe du soleil et les radiateurs.
- À l'écart des sources de vibration ou des chocs physiques.
- Isolé des champs électromagnétiques importants produits par des appareils électriques.
- Dans les régions sujettes aux orages magnétiques, nous vous recommandons de brancher votre système à un suppresseur de surtension et de déconnecter les lignes de télécommunication de votre modem pendant les orages.
- Équipé d'une prise murale reliée à la terre.
- Équipé d'un espace suffisant pour accéder aux cordons d'alimentation secteur, car ils servent de disjoncteur principal d'alimentation du produit.

Pratiques de manipulation de l'équipement

Réduisez le risque de dommages personnels ou matériels :

- Conformez-vous aux exigences de médecine du travail et de sécurité lorsque vous déplacez et soulevez le matériel.
- Utilisez l'assistance mécanique ou toute autre assistance appropriée lorsque vous déplacez et soulevez le matériel.
- Pour réduire le poids en vue de faciliter la manipulation, retirez tout composant amovible.

Alimentation et avertissements en matière d'électricité

Attention: Le bouton d'alimentation, indiqué par le symbole de mise en veille, NE COUPE PAS complètement l'alimentation secteur du système car le courant de veille 5 V reste actif lorsque le système est sous tension. Pour couper l'alimentation du système, vous devez débrancher le cordon d'alimentation secteur de la prise murale. Votre système peut utiliser plusieurs cordons d'alimentation secteur. Assurez-vous que tous les cordons d'alimentation sont débranchés. Vous devez les débrancher avant d'ouvrir le châssis, d'ajouter ou de supprimer un composant non connectable à chaud.

Les alimentations de certains serveurs Intel sont munies de doubles fusibles pôle/neutre: veuillez observer les précautions d'usage afin d'éviter tout risque d'électrocution.

N'essayez pas de modifier ou d'utiliser un cordon d'alimentation secteur s'il ne s'agit pas du type exact requis. Un cordon secteur est requis pour chaque alimentation système.

Le bloc d'alimentation de ce produit ne contient aucun composant réparable par l'utilisateur. N'ouvrez pas le bloc d'alimentation. L'intérieur de celui-ci est soumis à des niveaux dangereux de tension, de courant et d'énergie. Renvoyez-le au fabricant en cas de problème.

Lorsque vous remplacez un bloc d'alimentation à chaud, débranchez le cordon du bloc d'alimentation en cours de remplacement avant de le retirer du serveur.

Pour éviter tout risque d'électrocution, mettez le système hors tension et débranchez les cordons d'alimentation ainsi que les systèmes de télécommunication, réseaux et modems reliés au système avant d'ouvrir ce dernier.

Avertissements sur le cordon d'alimentation

Si aucun cordon d'alimentation secteur n'a été fourni avec votre produit, vous devez vous en procurer un qui soit approuvé pour une utilisation dans votre pays.

Attention: Pour éviter tout risque d'électrocution ou d'incendie, vérifiez les cordons d'alimentation qui seront utilisés avec le produit comme suit:

- N'essayez pas d'utiliser ou de modifier les cordons d'alimentation en CA s'ils ne correspondent pas exactement au type requis pour les prises électriques reliées à la terre.
- Les cordons d'alimentation doivent répondre aux critères suivants :
- Le cordon d'alimentation doit supporter une intensité supérieure à celle indiquée sur le produit.
- Le cordon d'alimentation doit posséder une broche ou un contact de mise à la terre approprié à la prise électrique.
- Les cordons d'alimentation électrique représentent le principal dispositif de déconnexion raccordé à l'alimentation secteur. Les prises de courant doivent se trouver à proximité de l'équipement et être facilement accessibles pour une déconnexion.
- Les cordons d'alimentation doivent être branchés sur des prises électriques correctement reliées à la terre.

Avertissements sur l'accès au système

Attention: Pour éviter de vous blesser ou d'endommager votre équipement, les consignes de sécurité suivantes s'appliquent chaque fois que vous accédez à l'intérieur du produit:

- Mettez hors tension tous les périphériques connectés à ce produit.
- Éteignez le système en appuyant sur le bouton d'alimentation.
- Déconnectez l'alimentation secteur en débranchant tous les cordons d'alimentation secteur du système ou de la prise murale.
- Déconnectez l'ensemble des câbles et lignes de télécommunication qui sont connectés au système.
- Mettez toutes les vis ou autres attaches de côté lorsque vous retirez les panneaux d'accès. Une fois que vous avez terminé d'accéder à l'intérieur du produit, refixez le panneau d'accès avec les vis ou attaches d'origine.
- N'essayez pas d'accéder à l'intérieur du bloc d'alimentation. Il ne contient aucune pièce réparable. Renvoyez-le au fabricant en cas de problème.
- Mettez le serveur hors tension et débranchez tous les cordons d'alimentation avant d'ajouter ou de remplacer tout composant non connectable à chaud.
- Lorsque vous remplacez le bloc d'alimentation à chaud, débranchez le cordon du bloc d'alimentation en cours de remplacement avant de retirer le bloc du serveur.

Attention: Si le serveur a été utilisé, les processeurs et dissipateurs de chaleur installés peuvent être chauds. À moins que vous n'ajoutiez ou ne retiriez un composant connectable à chaud, laissez le système refroidir avant d'ouvrir les panneaux. Pour éviter tout risque d'entrer en contact avec un composant chaud lors d'une installation à chaud, prenez toutes les précautions nécessaires lorsque vous retirez ou installez des composants connectables à chaud.

Attention: Pour éviter de vous blesser, ne touchez pas les pales de ventilateur en mouvement. Si votre système est fourni avec une protection sur le ventilateur, ne mettez pas le système en route sans la protection en place.

Avertissements sur le montage en rack

Le rack doit être fixé à un support inamovible pour éviter qu'il ne bascule lors de l'extension d'un serveur ou d'un élément de l'équipement. Le rack doit être installé conformément aux instructions du fabricant.

Installez les équipements dans le rack en partant du bas, en plaçant le plus lourd en bas du rack.

N'étendez qu'un seul élément de l'équipement à partir du rack à la fois.

Vous êtes responsable de l'installation d'un disjoncteur principal d'alimentation pour la totalité du rack. Ce disjoncteur principal doit être rapidement accessible et doit être étiqueté comme contrôlant toute l'unité, et pas uniquement le ou les serveurs.

Pour éviter tout risque d'électrocution, le rack et chaque élément de l'équipement installé dans le rack doivent être correctement reliés à la terre.

Décharges électrostatiques (ESD)

Attention: *Les décharges électrostatiques (ESD) peuvent endommager les lecteurs de disque dur, les cartes et d'autres pièces. Il est fortement conseillé d'effectuer l'ensemble des procédures décrites à un poste de travail protégé contre les ESD. Au cas où aucun poste de ce type ne serait disponible, protégez-vous contre les ESD en portant un bracelet antistatique relié à la masse du châssis (n'importe quelle surface métallique non peinte) de votre serveur lorsque que vous manipulez les pièces.*

Manipulez toujours les cartes avec précaution. Elles peuvent être extrêmement sensibles aux ESD. Ne tenez les cartes que par leurs bords. Après avoir retiré une carte de son emballage de protection ou du serveur, placez-la sur une surface reliée à la terre, exempte de charge statique, composants orientés vers le haut. Utilisez si possible un tapi de mousse conducteru, mais pas l'emballage de la carte. Veillez à ce que la carte ne glisse sur aucune surface.

Autres risques

Remplacement de la pile

Attention: *Il existe un risque d'explosion si la pile n'est pas correctement remplacée. Lors du remplacement de la pile, utilisez uniquement celle recommandée par le fabricant du matériel.*

Mettez la pile au rebut en vous conformant aux réglementations locales.

N'essayez pas de recharger une pile.

N'essayez pas de démonter, de percer ou d'endommager la pile d'une quelconque façon.

Refroidissement et ventilation

Attention: *Routez les câbles avec précaution comme indiqué pour minimiser les blocages de circulation d'air et les problèmes de refroidissement.*

Afin de permettre une ventilation et un refroidissement corrects, ne mettez le système en marche que lorsque les panneaux du châssis sont en place. L'utilisation du système sans les panneaux peut endommager les composants système. Pour installer les panneaux :

- Vérifiez tout d'abord que vous n'avez pas oublié d'outils ou de composants détachés à l'intérieur du système.
- Vérifiez que les câbles, les cartes d'extension et les autres composants sont correctement installés.
- Fixez les panneaux au châssis en suivant les instructions du produit.

Périphériques laser

Attention: *Pour éviter tout risque d'exposition aux rayonnements et/ou de dommage personnel:*

- *N'ouvrez pas l'enceinte d'un périphérique laser.*
- *Les périphériques laser ne sont pas réparables par l'utilisateur.*
- *Retournez-les au fabricant en cas de problème.*

Español

Información de seguridad del servidor

Este documento se aplica a las tarjetas de servidor de Intel[®], las carcasas de servidor de Intel[®] (montaje en bastidor y en pedestal) y los dispositivos periféricos. Para reducir el riesgo de daños corporales, descargas eléctricas, fuego y en el equipo, lea este documento y preste atención a todas las advertencias y precauciones de esta guía antes de instalar o mantener el producto de servidor de Intel[®].





En el caso de que haya diferencias entre la información para un producto en particular contenida en este documento y la información proporcionada con dicho producto o en el sitio Web, la documentación del producto es la que prevalece.

Sólo personal técnico cualificado debe montar y prestar los servicios para el servidor.

Debe ceñirse a las directrices de esta guía y a las instrucciones de montaje de los manuales del servidor para asegurar y mantener el cumplimiento con las certificaciones y homologaciones existentes de los productos. Utilice sólo los componentes descritos y homologados que se especifican en esta guía. El uso de otros productos o componentes anulará la homologación UL y otras certificaciones oficiales del producto, pudiendo dejar de ser compatible con las normativas locales de los países en los que se comercializa.

Advertencias y precauciones sobre seguridad

Para reducir la posibilidad de que se produzcan lesiones personales o daños en la propiedad, antes de empezar a instalar el producto, lea, observe y cumpla toda la información e instrucciones de seguridad siguientes. Puede que se utilicen los siguientes símbolos de seguridad en la documentación y es posible que aparezcan en el producto o en su embalaje.

PRECAUCIÓN	Indica la existencia de un riesgo que podría causar lesiones personales o daños en la propiedad leves si no se tiene en cuenta la PRECAUCIÓN.
ADVERTENCIA	Indica la existencia de un riesgo que podría causar lesiones personales graves si no se tiene en cuenta la ADVERTENCIA.
	Indica un riesgo potencial si no se tiene en cuenta la información indicada.
	Indica riesgo de descargas eléctricas que podrían causar lesiones graves o la muerte si no se siguen las instrucciones de seguridad.
	Indica componentes o superficies calientes.
	Indica que no se deben tocar las aspas de los ventiladores, ya que de lo contrario se podrían producir lesiones.



Indica que es necesario desenchufar los cables de alimentación de CA para desconectar la alimentación de CA



Recicle por favor la batería

Aplicaciones y usos previstos

Este producto ha sido evaluado como equipo de tecnología informática (ITE) que puede instalarse en oficinas, escuelas, salas de equipos informáticos o lugares de ámbito comercial similares. Es posible que sea necesario llevar a cabo una evaluación adicional para comprobar si este producto es apropiado para otras categorías de productos y entornos además de las aplicaciones informáticas (por ejemplo, soluciones médicas, industriales, residenciales, sistemas de alarma y equipos de pruebas).

Selección de la ubicación

El sistema se ha diseñado para funcionar en un entorno normal de oficinas. Seleccione una ubicación que esté:

- Limpia, seca y libre de macropartículas en suspensión en el aire (que no sean el polvo habitual de la habitación).
- Bien ventilada y alejada de fuentes de calor, incluida la luz solar directa y los radiadores.
- Alejada de fuentes de vibración o de golpes físicos.
- Aislada de campos electromagnéticos producidos por dispositivos eléctricos.
- En zonas propensas a tormentas eléctricas, se recomienda que conecte el servidor a un supresor de sobretensiones y desconecte las líneas de telecomunicaciones al módem durante una tormenta eléctrica.
- Provista de una toma de corriente alterna correctamente conectada a tierra.
- Provista de espacio suficiente para acceder a los cables de la fuente de alimentación ya que constituyen la desconexión principal de la alimentación.

Manipulación del equipo

Reduzca el riesgo de daños personales o en el equipo:

- Respete los requisitos de sanidad y seguridad laborales de su país cuando traslade y levante el equipo.
- Utilice medios mecánicos u otros que sean adecuados al trasladar o levantar el equipo.
- Para que el peso sea menor para manipularlo con más facilidad, extraiga los componentes que sean de fácil extracción.

Advertencias de alimentación y eléctricas

Precaución: El botón de encendido, indicado con la marca del modo de reposo o stand-by, NO DESCONECTA completamente la alimentación de CA del sistema, ya que el modo de reposo de 5 V sigue activo mientras el sistema está enchufado. Para desconectar el sistema debe desenchufar el cable de alimentación de CA de la toma de la pared. Puede usar más de un cable de alimentación de CA con el sistema. Asegúrese de que todos los cables de alimentación de CA estén desenchufados. Asegúrese de que los cables de alimentación de CA estén desenchufado antes de abrir la carcasa, agregar o extraer cualquier componente que no es de conexión en funcionamiento.

Algunas fuentes de alimentación de electricidad de los servidores de Intel utilizan el polo neutral del fuselaje. Para evitar riesgos de choques eléctricos use precauciones al trabajar con las fuentes de alimentación que utilizan el polo neutral de fuselaje.

No intente modificar ni utilizar un cable de alimentación de CA si no es del tipo exacto requerido. Se necesita un cable de CA para cada fuente de alimentación del sistema.

La fuente de alimentación de este producto no contiene piezas que puedan ser reparadas por el usuario. No abra la fuente de alimentación. Dentro de la fuente de alimentación puede haber niveles de tensión, corriente y energía peligrosos. Devuélvala al fabricante para repararla.

Al reemplazar una fuente de alimentación de conexión en funcionamiento, desenchufe el cable de alimentación de la fuente de alimentación que va a reemplazar antes de extraerla del servidor.

Para evitar el riesgo de descargas eléctricas, antes de abrir el servidor, apáguelo, desconecte el cable de alimentación, los sistemas de telecomunicaciones, las redes y los módems conectados al mismo.

Advertencias sobre el cable de alimentación

Si no se ha proporcionado con el producto ningún cable de alimentación de CA, adquiera alguno cuyo uso esté aprobado en su país.

Precaución: Para evitar descargas eléctricas o fuego, revise los cables de alimentación que usará con el producto tal y como se describe a continuación:

- No intente modificar ni utilizar los cables de alimentación de CA si no son exactamente del modelo especificado para ajustarse a las tomas de corriente conectadas a tierra
- Los cables de alimentación deben reunir los siguientes requisitos:
- El cable de alimentación debe disponer de una capacidad nominal de corriente eléctrica mayor que la capacidad especificada en el producto.
- El cable de alimentación debe disponer de una patilla o contacto de conexión a tierra que sea apto para la toma de corriente.
- Los cables de la fuente de alimentación son los dispositivos de desconexión principales a la corriente alterna. El enchufe o enchufes de zócalo deben encontrarse cerca del equipo y el acceso a ellos debe poderse efectuar de forma inmediata con el fin de desconectarlos.

- Los cables de la fuente de alimentación deben estar conectados a los enchufes con una toma de tierra adecuada.

Advertencias el acceso al sistema

Precaución: Para evitar lesiones personales o daños en la propiedad, se aplican las siguientes instrucciones de seguridad siempre que se acceda al interior del producto:

- Apague todos los dispositivos periféricos conectados a este producto.
- Pulse el botón de alimentación para apagar el sistema.
- Desconecte la alimentación de CA desenchufando los cables de alimentación de CA del sistema o de la toma de corriente alterna.
- Desconecte todos los cables y líneas de telecomunicación que estén conectados al sistema.
- Guarde todos los tornillos o elementos de fijación cuando retire las cubiertas de acceso. Cuando termine de operar en el interior del producto, vuelva a colocar los tornillos o los elementos de fijación originales de la cubierta de acceso.
- No acceda al interior de la fuente de alimentación. No hay elementos en la fuente de alimentación que usted pueda reparar y utilizar. Devuélvala al fabricante para repararla.
- Apague el servidor y desconecte todos los cables de alimentación antes de agregar o reemplazar cualquier componente que no es de conexión en funcionamiento.
- Al reemplazar una fuente de alimentación de conexión en funcionamiento, desenchufe el cable de alimentación de la fuente de alimentación que va a reemplazar antes de extraerla del servidor.

Precaución: Si el servidor se ha estado ejecutando, los procesadores y disipadores de calor estarán recalentados. A no ser que esté instalando o extrayendo un componente de conexión en funcionamiento, deje que el sistema se enfríe antes de abrir las cubiertas. Para que no llegue a tocar los componentes que estén calientes cuando esté realizando una instalación de conexión en funcionamiento, tenga cuidado al extraer o instalar los componentes de conexión en funcionamiento.

Precaución: Para evitar posibles daños, no toque las aspas en movimiento de los ventiladores. Si el sistema se le ha suministrado con una protección para el ventilador, asegúrese de que cuando esté funcionando el sistema la protección esté en su sitio.

Advertencias sobre el montaje en bastidor

El bastidor del equipo se debe sujetar con un soporte fijo para evitar que se caiga cuando se extraiga un servidor o una pieza del mismo. El bastidor del equipo debe instalarse siguiendo las instrucciones del fabricante del bastidor.

Instale el equipo en el bastidor comenzando desde la parte de abajo, con el equipo más pesado en la parte inferior del bastidor.

Extraiga las piezas del equipo del bastidor de una a una.

El usuario es el responsable de la instalación de un dispositivo de desconexión de la alimentación principal para toda la unidad del bastidor. El acceso a este dispositivo de desconexión deberá ser de fácil acceso y deberán incluirse indicaciones que lo identifiquen como el control de alimentación eléctrica de toda la unidad, no sólo de los servidores.

Para evitar el riesgo de descargas eléctricas, deberá instalar una conexión a tierra apropiada para el bastidor y para cada pieza del equipo instalada en el mismo.

Descarga electrostática (ESD)

Precaución: *Las descargas electrostáticas pueden dañar las unidades de disco, las tarjetas y otros componentes. Recomendamos que realice todos los procedimientos en una estación de trabajo protegida contra descargas electrostáticas. En caso de que no haya una disponible, protéjase de alguna forma contra las descargas llevando un brazaletes antiestático conectado a la toma de tierra de la carcasa (cualquier superficie de metal que no esté pintada) del servidor cuando manipule las piezas.*

Manipule siempre las tarjetas con el máximo cuidado. Pueden ser sumamente sensibles a las descargas electrostáticas. Sujételas sólo por los bordes. Una vez extraída la tarjeta de su envoltorio de protección o del servidor, colóquela con el lado de los componentes hacia arriba sobre una superficie con toma de tierra y sin carga estática. Utilice una almohadilla de espuma conductora si dispone de ella, pero nunca el envoltorio de la tarjeta. No deslice la tarjeta sobre ninguna superficie.

Sustitución de la batería

Precaución: *Existe el peligro de explosión si la batería no se reemplaza correctamente. Al reemplazar la batería, utilice sólo la batería recomendada por el fabricante del equipo.*

Deseche las baterías respetando la normativa local.

No intente recargar la batería.

No intente desmontar, pinchar o causar cualquier otro desperfecto a una batería.

Enfriamiento y circulación de aire

Precaución: El tendido de los cables debe realizarse cuidadosamente tal y como se le indica para reducir al mínimo los problemas de obstrucción de la ventilación y de refrigeración.

Para conseguir una refrigeración y corriente de aire adecuadas, compruebe que cuando sistema esté funcionando, las cubiertas de la carcasa están instaladas. Si utiliza el sistema sin las cubiertas, podría dañar sus componentes. Para instalar las cubiertas:

- Compruebe primero que no ha dejado herramientas o piezas sueltas dentro del sistema.
- Compruebe que los cables, tarjetas adicionales y otros componentes están instalados correctamente.
- Sujete las cubiertas a la carcasa siguiendo las instrucciones del producto.

Periféricos o dispositivos láser

Precaución: Para evitar el riesgo de la exposición a radiaciones o de daños personales:

- No abra la caja de ningún periférico o dispositivo láser
- Los periféricos o dispositivos láser no pueden ser reparados por el usuario
- Haga que el fabricante los repare.

简体中文

服务器安全信息

本文档适用于 Intel® 服务器主板、Intel® 服务器机箱（基座和机架固定件）和已安装的外设。为减少人身伤害、电击、火灾以及设备损坏的危险，请在安装或维护 Intel® 服务器产品之前阅读本文档并遵循本指南中的所有警告和预防措施。





如果本文档中的信息与特定产品的随附信息或 Web 站点信息之间存在不一致，请以产品文档为准。

服务器须由合格的技术人员进行集成和维护。

必须遵守本指南的规定和服务器手册的装配指导，以确保符合现有的产品认证和审批。仅使用本指南中描述和规定的指定组件。使用其他产品 / 组件将使产品的认证和其他管理审批无效，并可能导致产品不符合销售地的产品法规。

安全警告与注意事项

为避免人身伤害与财产损失，安装本产品之前，请阅读以下所有安全指导和信息。下面所列的安全符号可能在整个文档中使用并可能标注于产品和 / 或产品包装之上。

注意	表示如果无视此“???”项”?????? 轻微人身伤害或财产损失的危险。
警告	表示如果无视此“??”?????? 严重人身伤害的危险。
	表示如果无视所示信息，即存在潜在的危险。
	表示如果不遵守安全指导，存在可导致严重伤害或死亡的电击危险。
	表示灼热组件或表面。
	表示请勿触摸风机叶片，否则可能致伤。
	表示拔下所有交流电线，断开交流电源

预期应用使用

根据评估，本产品为信息技术设备 (ITE)，可安装在办公室、学校、计算机房和类似的商业场所。本产品对于非 ITE 应用的其他产品种类和环境（如医疗、工业、住宅、报警系统和测试设备）的适用性尚有待进一步的评估。

场地选择

本系统专为在典型办公环境运行而设计。请选择符合以下条件的地点：

- 清洁、干燥，无气载微粒（而非一般的室内尘埃）。
- 通风良好，远离热源（包括直接日晒和散热器）。
- 远离振动源或物理震动。
- 与电气设备产生的强大电磁场隔离。
- 在易受闪电袭击的地区，我们建议将系统插入电涌抑制器并在闪电期间断开通信线路与调制解调器之间的连接。
- 提供正确接地的墙壁插座。
- 提供足够的空间，以便拿取电源供应线，因为这是本产品的主要电源断开器。

设备操作规范

减少人身伤害或设备受损的危险：

- 移举设备时遵守当地的职业健康与安全要求。
- 借助机械手段或其他合适的手段移举设备。
- 拆除一切易分离组件，以降低重量并方便操作。

电源与电气警告

注意事项

电源按钮（如待机电源标记所示）并不能完全关闭系统的交流电源，只要系统已接通电源，就存在 5V

待机电源。要从系统切断电源，须从墙壁电源插座中拔下交流电线。您的系统可能不止使用一根交流电线。请确保所有的交流电线都已拔下。打开机箱或增加或去除任何热插拔组件之前，确保交流电线已拔下。

若非所需的确切类型，请勿尝试修改或使用交流电线。系统的每个电源供应设备都需要一根单独的交流电线。

本产品的电源供应设备包含非用户维修部件。请勿打开电源供应设备。电源供应设备包含非常危险的电压级、电流级和能量级。请与生产商联系维修事宜。

替换热插拔电源供应设备时，请先拔下需替换的电源供应设备上的电源线，再将其从服务器上移除。

为避免电击，请在打开服务器之前，关闭服务器并断开服务器上连接的电源线、电信系统、网络和调制解调器。

电源线警告

如果产品未提供交流电线，请购买一根您所在国家批准使用的交流电线。

注意事项

为避免电击或火灾危险，请按如下所述对产品所用的电源线进行检查：

- 若非所需的符合接地插座的确切类型，请勿尝试修改或使用交流电线
- 电源线须符合以下标准：
 - 电源线的电气额定值须大于产品上标注的电流额定值。
 - 电源线须拥有适合插座的安全接地插头或触点。
- 电源线为交流电源的主要断开设备。插座须靠近设备并可随时断开。
- 电源线须插入所提供的拥有合适接地的插座。

系统使用警告

注意事项

为避免人身伤害或财产损失，无论何时检查产品内部，以下安全指导都适用：

- 关闭所有与本产品相连的外设。
- 按下电源按钮至关闭状态，关闭系统。
- 从系统或墙壁插座上拔下所有交流电线，断开交流电源。
- 断开与系统相连的所有线缆和通信线路。
- 卸除舱口盖时，保留所有螺钉及其他紧固件。完成产品内部检查之后，请用螺钉或紧固件重新固定舱口盖。
- 请勿打开电源供应设备。电源供应设备内没有可维修部件。请与生产商联系维修事宜。
- 增加或替换任何非热插拔组件之前，请关闭服务器电源并断开所有电源线。
- 替换热插拔电源供应设备时，请先拔下需替换的电源供应设备上的电源线，然后再从服务器上移除电源供应设备。

注意事项

如果服务器一直在运行，任何已安装的处理器和吸热设备都可能很热。除非要增加或移除热插拔组件，否则请待系统冷却后再开盖。为避免在热插拔组件安装过程中接触灼热组件，移除或安装热插拔组件时务须小心。

注意事项

为避免受伤，请勿触摸运转的风机叶片。如果系统的风机上配有防护装置，请勿卸下风机防护装置运行系统。

机架固定件警告

设备的机架须固定在稳固的支座上，以防从中安装服务器或设备时倒塌。须按照机架生产商提供的安装说明进行安装。

从下往上将设备安装在机架上，最重的设备安装在机架的最底层。

一次只从机架上安装一件设备。

您须负责安装整个机架装置的主要电源断开设备。此主要断开设备须随时可用，且须标明为控制整个装置（而不仅限于服务器）的电源。

为避免潜在的电击危险，须对机架及其上所安装的每一件设备实行正确的安全接地。

静电放电（ESD）

注意事项

ESD 会损坏磁盘驱动器、主板及其他部件。我们建议您执行 ESD

工作站的所有步骤。如果没有 ESD

工作站，则采取一些静电放电保护措施，操作部件时，戴上与服务器上的机箱接地或任何未喷漆金属表面连接的防静电腕带。

操作主板时始终保持小心。它们可能对 ESD

非常敏感。拿持主板时只接触边缘。从保护包装中或从服务器上取出主板后，请将主板组件侧面朝上放置在不带电的接地表面上。请使用导电泡沫垫（若有），不要使用主板包装。请勿将主板在任何表面上滑动。

其他危险

替换电池

注意事项

不正确替换电池可能导致爆炸危险。替换电池时，请只使用设备生产商推荐使用的电池。

请按当地法规处置电池。

请勿对电池充电。

请勿拆卸、刺穿或以其他方式损坏电池。

冷却和气流

注意事项

按照说明小心布置线缆，尽量减少气流阻塞和冷却问题。

为保证适当的冷却和气流，运行系统时请确保机箱盖已安装。未安装机箱盖即运行系统可能导致系统部件受损。安装机箱盖的步骤如下：

- 首先检查并确保系统内没有遗留的未固定工具或部件。
- 检查线缆、内插板和其他组件已正确安装。
- 按产品说明安装机箱盖。

激光外设或激光设备

注意事项

为避免幅射暴露和 / 或人身伤害：

- 请勿打开任何激光外设或激光设备的外壳
- 激光外设或激光设备为非用户维修设备

请与生产商联系维修事宜

Appendix F: Getting Help

World Wide Web

<http://support.intel.com/support/motherboards/server/SR9000MK4U>.

Telephone

All calls are billed per incident, levied in local currency at the applicable credit card exchange rate plus applicable taxes. (Intel reserves the right to change the pricing for telephone support at any time without notice).

Before calling, fill out a server issue report form. For the fastest service, please submit your form via the Internet.

For an updated support contact list, see <http://www.intel.com/support/9089.htm/>

U.S. and Canada

1-800-404-2284

Europe

Belgium 02 714 3182

Denmark ... 38 487077

Finland 9 693 79297

France..... 01 41 918529

Germany ... 069 9509 6099

Holland 020 487 4562

Italy..... 02 696 33276

Norway 23 1620 50

Spain..... 91 377 8166

Sweden..... 08 445 1251

UK..... 870 6072439

In Asia-Pacific Region

Australia.... 1800 649931

Cambodia.. 63 2 636 9797 (via Philippines)

China 800 820 1100 (toll-free)
..... 8 621 33104691 (not toll-free)

Hong Kong 852 2 844 4456

India..... 0006517 2 68303634 (manual toll-free. You need an IDD-equipped telephone)

Indonesia ... 803 65 7249

Korea 822 767 2595

Malaysia 1 800 80 1390

Myanmar... 63 2 636 9796 (via Philippines)

New Zealand 0800 444 365

Pakistan.... 632 63684 15 (IDD via Philippines)

Philippines 1 800 1 651 0117

Singapore .. 65 6213-1311

Taiwan 2 2545-1640

Thailand 1 800 631 0003

Vietnam 632 6368416 (IDD via Philippines)

Japan

Domestic.... 0120 868686

Outside country 81 298 47 0800

Latin America

Argentina .. Contact AT&T USA at 0-800 222 1288. Once connected, dial 800 843 4481

Brazil 001-916 377 0180

Chile

Easter Island. Contact AT&T USA at 800 800 311. Once connected, dial 800 843 4481

Mainland and Juan .. Contact AT&T USA at 800 225 288. Once connected, dial 800 843 4481

Colombia... Contact AT&T USA at 01 800 911 0010. Once connected, dial 800 843 4481

Costa Rica . Contact AT&T USA at 0 800 0 114 114. Once connected, dial 800 843 4481

Ecuador

(Andimate) Contact AT&T USA at 1 999 119. Once connected, dial 800 843 4481

(Pacifictel) Contact AT&T USA at 1 800 225 528. Once connected, dial 800 843 4481

Guatemala. Contact AT&T USA at 99 99 190. Once connected, dial 800 843 4481

Mexico Contact AT&T USA at 001 800 462 628 4240. Once connected, dial 800 843 4481

Miami 1 800 621 8423

Panama..... Contact AT&T USA at 00 800 001 0109. Once connected, dial 800 843 4481

Paraguay ... 001 916 377 0114

Peru 001 916 377 0114

Uruguay..... 001 916 377 0114

Venezuela... Contact AT&T USA at 0 800 2255 288. Once connected, dial 800 843 4481

Appendix G: Regulatory and Compliance Information

To ensure regulatory compliance, you must adhere to the assembly instructions in this guide to ensure and maintain compliance with existing product certifications and approvals. Use only the described, regulated components specified in this guide. Use of other products / components will void the UL listing and other regulatory approvals of the product and will most likely result in noncompliance with product regulations in the region(s) in which the product is sold.

To help ensure EMC compliance with your local regional rules and regulations, before computer integration, make sure that the chassis, power supply, and other modules have passed EMC testing using a server board with a microprocessor from the same family (or higher) and operating at the same (or higher) speed as the microprocessor used on this server board. The final configuration of your end system product may require additional EMC compliance testing. For more information please contact your local Intel Representative.

This is an FCC Class A device. Integration of it into a Class B chassis does not result in a Class B device.

Product Regulatory Compliance

The Server Chassis product, when correctly integrated per this guide, complies with the following safety and electromagnetic compatibility (EMC) regulations.

Intended Application - This product was evaluated as Information Technology Equipment (ITE), which may be installed in offices, schools, computer rooms, and similar commercial type locations. The suitability of this product for other product categories and environments (such as: medical, industrial, telecommunications, NEBS, residential, alarm systems, test equipment, etc.), other than an ITE application, may require further evaluation.

Product Safety Compliance

The Intel® Server System SR9000MK4U complies with the following safety requirements:

- UL60950 - CSA 60950 (USA / Canada)
- EN60950 (Europe)
- IEC60950 (International)
- CB Certificate & Report, IEC60950 (report to include all country national deviations)

- GS License (Germany)
- GOST R 50377-92 - License (Russia)
- Belarus License (Belarus)
- Ukraine License (Ukraine)
- CE - Low Voltage Directive 73/23/EEE (Europe)
- IRAM Certification (Argentina)
- GB4943- CNCA Certification (China)

Product EMC Compliance - Class A Compliance

Note: Legally the product is required to comply with Class A emission requirements as it is intended for a commercial type market place. Intel targets 10db margin to Class A Limits

- FCC / ICES-003 - Emissions (USA/Canada) Verification
- CISPR 22 - Emissions (International)
- EN55022 - Emissions (Europe)
- EN55024 - Immunity (Europe)
- EN61000-3-2 - Harmonics (Europe)
- EN61000-3-3 - Voltage Flicker (Europe)
- CE - EMC Directive 89/336/EEC (Europe)
- VCCI Emissions (Japan)
- AS/NZS 3548 Emissions (Australia / New Zealand)
- BSMI CNS13438 Emissions (Taiwan)
- GOST R 29216-91 Emissions (Russia)
- GOST R 50628-95 Immunity (Russia)
- Belarus License (Belarus)
- Ukraine License (Ukraine)
- RRL MIC Notice No. 1997-41 (EMC) & 1997-42 (EMI) (Korea)
- GB 9254 - CNCA Certification (China)
- GB 17625 - (Harmonics) CNCA Certification (China)

Certifications / Registrations / Declarations

- UL Certification (US/Canada)
- CE Declaration of Conformity (CENELEC Europe)
- FCC/ICES-003 Class A Attestation (USA/Canada)
- VCCI Certification (Japan)

- C-Tick Declaration of Conformity (Australia)
- MED Declaration of Conformity (New Zealand)
- BSMI Certification (Taiwan)
- GOST R Certification / License (Russia)
- Belarus Certification / License (Belarus)
- RRL Certification (Korea)
- IRAM Certification (Argentina)
- CNCA Certification (China)
- Ecology Declaration (International)

Electromagnetic Compatibility Notices

FCC Verification Statement (USA)

This device complies with Part 15 of the FCC Rules. Operation is subject to the following two conditions: (1) this device may not cause harmful interference, and (2) this device must accept any interference received, including interference that may cause undesired operation.

For questions related to the EMC performance of this product, contact:

Intel Corporation
5200 N.E. Elam Young Parkway
Hillsboro, OR 97124-6497
1-800-628-8686

This equipment has been tested and found to comply with the limits for a Class A digital device, pursuant to Part 15 of the FCC Rules. These limits are designed to provide reasonable protection against harmful interference in a residential installation. This equipment generates, uses, and can radiate radio frequency energy and, if not installed and used in accordance with the instructions, may cause harmful interference to radio communications. However, there is no guarantee that interference will not occur in a particular installation. If this equipment does cause harmful interference to radio or television reception, which can be determined by turning the equipment off and on, the user is encouraged to try to correct the interference by one or more of the following measures:

- Reorient or relocate the receiving antenna.
- Increase the separation between the equipment and the receiver.
- Connect the equipment to an outlet on a circuit other than the one to which the receiver is connected.
- Consult the dealer or an experienced radio/TV technician for help.

Any changes or modifications not expressly approved by the grantee of this device could void the user's authority to operate the equipment. The customer is responsible for ensuring compliance of the modified product.

Only peripherals (computer input/output devices, terminals, printers, etc.) that comply with FCC Class A or B limits may be attached to this computer product. Operation with noncompliant peripherals is likely to result in interference to radio and TV reception.

All cables used to connect to peripherals must be shielded and grounded. Operation with cables, connected to peripherals, that are not shielded and grounded may result in interference to radio and TV reception.

Industry Canada (ICES-003)

Cet appareil numérique respecte les limites bruits radioélectriques applicables aux appareils numériques de Classe A prescrites dans la norme sur le matériel brouilleur: "Appareils Numériques", NMB-003 édictée par le Ministre Canadien des Communications.

English translation of the notice above:

This digital apparatus does not exceed the Class A limits for radio noise emissions from digital apparatus set out in the interference-causing equipment standard entitled: "Digital Apparatus," ICES-003 of the Canadian Department of Communications.

Europe (CE Declaration of Conformity)

This product has been tested in accordance too, and complies with the Low Voltage Directive (73/23/EEC) and EMC Directive (89/336/EEC). The product has been marked with the CE Mark to illustrate its compliance.

VCCI (Japan)

この装置は、情報処理装置等電波障害自主規制協議会（VCCI）の基準に基づくクラスA情報技術装置です。この装置を家庭環境で使用すると電波妨害を引き起こすことがあります。この場合には使用者が適切な対策を講ずるよう要求されることがあります。

English translation of the notice above:

This is a Class A product based on the standard of the Voluntary Control Council for Interference (VCCI) from Information Technology Equipment. If this is used near a radio or television receiver in a domestic environment, it may cause radio interference. Install and use the equipment according to the instruction manual.

BSMI (Taiwan)

The BSMI Certification Marking and EMC warning is located on the outside rear area of the product.

警告使用者：
這是甲類的資訊產品，在居住的環境中使用時，可能會造成射頻干擾，在這種情況下，使用者會被要求採取某些適當的對策

RRL (Korea)

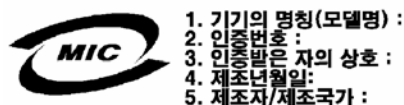

English translation of the notice above:

1. Type of Equipment (Model Name): On License and Product
2. Certification No.: On RRL certificate. Obtain certificate from local Intel representative
3. Name of Certification Recipient: Intel Corporation
4. Date of Manufacturer: Refer to date code on product
5. Manufacturer/Nation: Intel Corporation/Refer to country of origin marked on product

CNCA (CCC China)

The CCC Certification Marking and EMC warning is located on the outside rear area of the product.

声明

此为A级产品，在生活环境中，该产品可能会造成无线电干扰。在这种情况下，可能需要用户对其干扰采取可行的措施。

Regulated Specified Components

To maintain the UL listing and compliance to other regulatory certifications and/or declarations, the following regulated components must be used and conditions adhered to. Interchanging or use of other component will void the UL listing and other product certifications and approvals.

Updated product information for configurations can be found on the Intel Server Builder Web site at the following URL:

<http://channel.intel.com/go/serverbuilder>

If you do not have access to Intel's Web address, please contact your local Intel representative.

- **Server Chassis:** (base chassis is provided with power supply and fans) UL listed.
- **Server board:** you must use an Intel server board-UL recognized.
- **Add-in boards:** must have a printed wiring board flammability rating of minimum UL94V-1. Add-in boards containing external power connectors and/or lithium batteries must be UL recognized or UL listed. Any add-in board containing modem telecommunication circuitry must be UL listed. In addition, the modem must have the appropriate telecommunications, safety, and EMC approvals for the region in which it is sold.
- **Peripheral Storage Devices:** must be UL recognized or UL listed accessory and TUV or VDE licensed. Maximum power rating of any one device is 19 watts. Total server configuration is not to exceed the maximum loading conditions of the power supply.

Restriction of Hazardous Substances (RoHS) Compliance

Intel has a system in place to restrict the use of banned substances in accordance with the European Directive 2002/95/EC. Compliance is based on declaration that materials banned in the RoHS Directive are either (1) below all applicable threshold limits or (2) an approved / pending RoHS exemption applies.

RoHS implementation details are not fully defined and may change.

Threshold limits and banned substances are noted below:

- Quantity limit of 0.1% by mass (1000 PPM) for:
 - Lead
 - Mercury
 - Hexavalent Chromium
 - Polybrominated Biphenyls Diphenyl Ethers (PBDE)
- Quantity limit of 0.01% by mass (100 PPM) for:
 - Cadmium

End of Life / Product Recycling

Product recycling and end-of-life take-back systems and requirements vary by country. Contact the retailer or distributor of this product for information about product recycling and / or take-back.

