



# Intel<sup>®</sup> Integrated RAID Controller SRCS14L

Four-port Low Profile Serial ATA RAID Controller  
Hardware Installation and User's Guide, Version 1.0

---

November 2002

Information in this document is provided in connection with Intel® products. No license, express or implied, by estoppel or otherwise, to any intellectual property rights is granted by this document. Except as provided in Intel's Terms and Conditions of Sale for such products, Intel assumes no liability whatsoever, and Intel disclaims any express or implied warranty, relating to sale and/or use of Intel products including liability or warranties relating to fitness for a particular purpose, merchantability, or infringement of any patent, copyright or other intellectual property right. Intel products are not intended for use in medical, life saving, or life sustaining applications.

Intel may make changes to specifications and product descriptions at any time, without notice.

Designers must not rely on the absence or characteristics of any features or instructions marked "reserved" or "undefined." Intel reserves these for future definition and shall have no responsibility whatsoever for conflicts or incompatibilities arising from future changes to them.

The RAID Adapter may contain design defects or errors known as errata which may cause the product to deviate from published specifications. Current characterized errata are available on request.

This RAID Adapter as well as the software described in it is furnished under license and may only be used or copied in accordance with the terms of the license. The information in this manual is furnished for informational use only, is subject to change without notice, and should not be construed as a commitment by Intel Corporation. Intel Corporation assumes no responsibility or liability for any errors or inaccuracies that may appear in this document or any software that may be provided in association with this document. Except as permitted by such license, no part of this document may be reproduced, stored in a retrieval system, or transmitted in any form or by any means without the express written consent of Intel Corporation.

Copyright © Intel Corporation, 2002

\*Other names and brands may be claimed as property of others.



# Contents

---

<b>1</b>	<b>Getting Started</b>	
1.1	Using the User Documentation Set .....	5
1.1.1	Document Formats .....	6
1.2	About This Guide .....	6
1.3	Customer Support Contact Information .....	6
1.4	Regulatory and Certification Information .....	7
1.4.1	Product Regulatory Compliance .....	7
1.4.2	Product Safety Compliance .....	7
1.4.3	Product EMC Compliance .....	7
1.4.4	Product Regulatory Compliance Markings .....	8
1.4.5	Electromagnetic Compatibility Notices .....	8
1.5	Warnings and Cautions .....	11
<b>2</b>	<b>Hardware Installation</b>	
2.1	Installation Procedures .....	13
2.1.1	Computer System Hardware Requirements .....	13
2.1.2	Installing the IIR Controller .....	14
2.1.3	Changing Jumper Settings .....	15
2.2	Diagnostic Features .....	17
2.2.1	LED Indicators .....	17
2.2.2	Audible Alarm .....	18
2.2.3	Beep Sequences During System Boot .....	19
<b>3</b>	<b>Hardware Specifications and Features</b>	
3.1	IIR Controller Hardware Features .....	20
3.1.1	Key Features .....	20
3.2	Operating System Support .....	22
3.3	Supported Hard Drive Technology .....	22
3.4	Array Roaming Compatibility .....	22
3.5	PCI Hot Plug .....	22
3.6	Hot-Plug Disk Drive Support .....	23
3.7	Auto-detection of Hot-Plug Disk Drives in a Non-Intelligent Drive Enclosure .....	23
3.8	RAID Controller Drive Limitations (Host, Array, Logical, and Physical) .....	23
<b>A</b>	<b>Flash Memory Programming</b>	
A.1	About Firmware Files .....	24
A.2	Choosing Update vs. Recover .....	24
A.3	Setting Jumper J1 .....	24
A.4	Updating or Recovering Firmware Using the FRUU .....	25
A.4.1	Creating Firmware Diskettes from the CD-ROM Autorun Menu .....	26
A.4.2	Creating Firmware Diskettes from the Bootable RAID Software Suite CD-ROM .....	27
A.4.3	Running the FRUU .....	27
A.5	Updating Firmware Using XROM StorCon .....	29

## Figures

2-1	IIR Controller Component Layout .....	14
2-2	Installing the IIR Controller into a Computer System.....	15
2-3	Jumper Locations and Pin Numbers .....	16
2-4	LED Labels and Colors.....	17

## Tables

2-1	Controller Jumper Settings .....	17
2-2	LED Descriptions.....	18
2-3	Beep Sequences .....	19
3-1	Hardware Architecture .....	20
3-2	Environmental Specifications .....	21
3-3	RAID Controller Drive Maximum Limitations (SRCS14L).....	23

# Getting Started

# 1

## Intended Audience

This documentation is intended for users who are experienced in configuring computer systems with new add-in cards or have had previous experience with Intel® Integrated RAID (IIR) Controllers.

Read and adhere to all warnings, cautions, and notices in this guide and the other documents in the user documentation set supplied with this product.

## 1.1 Using the User Documentation Set

User documentation for this product is provided in four separate documents:

### Installation Quick Start Poster

The *Installation Quick Start Poster*, or *Quick Start Poster*, provides a high level view of installing and configuring a RAID controller. Refer to the accompanying *Software Guide* for more detailed information.

### Hardware Installation and User's Guide

The *Hardware Installation and User's Guide*, or *Hardware Guide*, covers instructions for installing an IIR controller and provides a guide to its features and specifications. For a particular IIR controller, its hardware guide documents compatible RAID adapters, supported operating systems, standard features and optional features.

### Software Installation and User's Guide

The *Software Installation and User's Guide*, or *Software Guide*, contains:

- Quick installation of the IIR controller software on a newly created bootable host drive with commonly used operating systems.
- Detailed instructions covering more complex software installation scenarios for all supported operating systems.
- Instructions for using the RAID Software Suite, the drivers, tools and utilities of the IIR controller.

The first part of the software guide provides an overview of RAID technology and its features. Next, the guide documents various installation procedures for an IIR controller and the RAID Software Suite, depending on the chosen OS configuration. The software guide then includes descriptions of the utilities, Storage Console (StorCon) and Storage Console Plus (StorCon+), to facilitate the configuration of the RAID subsystem. Finally, the guide provides details of all product features supported by the software and firmware. For further information refer to the Optional Features section of the appropriate hardware guide since not all features are applicable to all IIR controllers.



## Clustering Guide

The Intel® Integrated RAID *Controller Clustering Guide*, or *Clustering Guide*, describes how to set up clustering configurations using IIR Controllers and IIR controller software.

Information on Operating Systems, Cluster functionality, and other system details may be found in their corresponding system manuals.

### 1.1.1 Document Formats

All documents, with the exception of the quick start poster, are provided on the CD-ROM in both PDF and HTML format:

- **HTML**—To view online HTML documents, Click Documentation from the autorun menu or open <cdromdrive>:\docs\index.htm.
- **PDF**—Portable Document Format (PDF) documents can be opened, viewed, and printed with Adobe\* Acrobat Reader\* (not provided on the CD-ROM).

## 1.2 About This Guide

This guide contains three sections:

### Chapter 1, Getting Started

This chapter covers how to use the different user documents in the user documentation set, customer support contact information, and regulatory and license agreements covering this product.

### Chapter 2, Hardware Installation

This chapter contains the procedures for installing the IIR controller into a computer system.

### Chapter 3, Hardware Specifications and Features

This chapter covers all the hardware specifications associated with the IIR controller and its components and any optional RAID features that are supported by the RAID Software. The software guide covers in detail all software features.

## 1.3 Customer Support Contact Information

For product support, visit <http://support.intel.com>.

## 1.4 Regulatory and Certification Information

**Note:** This controller is intended for use in UL Listed computers or equivalent, that have instructions detailing installation.

### 1.4.1 Product Regulatory Compliance

The IIRRZ4CHSI (SRCS14L) RAID controller, when correctly integrated per this guide, complies with the following safety and electromagnetic compatibility (EMC) regulations.

### 1.4.2 Product Safety Compliance







- CSA C22.2, No. UL 60950/60950, 3<sup>rd</sup> Edition (US/Canada)
- EN 60950 (European Union)
- IEC 60950 (International)
- CE - Low Voltage Directive (73/23/EEC) (European Union)

### 1.4.3 Product EMC Compliance

- FCC Part 15, Class A Emissions (USA)
- ICES-003, Class A Emissions (Canada)
- CISPR 22, 3rd Edition, Class A Emissions (International)
- EN55022: 1998, Class A Emissions
- EN55024: 1998, Immunity
- CE - EMC Directive 89/336/EEC
- AS/NZS 3548, Class A Emissions (Australia / New Zealand)
- BSMI CNS13438, Class A Emissions (Taiwan)
- RRL, MIC Notice No. 1997-41 (EMC) & 1997-42 (EMI) (Korea)

## 1.4.4 Product Regulatory Compliance Markings

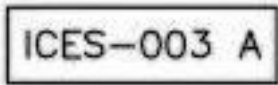
The IIRRZ4CHSI (SRCS14L) RAID controller is marked with the following regulatory markings:

Marking	Description
	UL Listed Accessory mark for USA and Canada
	CE mark for European Union
	C-Tick mark for Australia and New Zealand
	Taiwan BSMI Marking (Class A)
	Canada ICES Mark
	Korea MIC Mark

## 1.4.5 Electromagnetic Compatibility Notices

### 1.4.5.1 FCC Verification Statement (USA)

Product Type: IIRRZ4CHSI (SRCS14L)

This device complies with Part 15 of the FCC Rules. Operation is subject to the following two conditions: (1) This device may not cause harmful interference, and (2) this device must accept any interference received, including interference that may cause undesired operation.



This equipment has been tested and found to comply with the limits for a Class A digital device, pursuant to Part 15 of the FCC Rules. These limits are designed to provide reasonable protection against harmful interference when the equipment is operated in a commercial environment. This equipment generates, uses, and can radiate radio frequency energy and, if not installed and used in accordance with the instruction manual, may cause harmful interference to radio communications. Operation of this equipment in a residential area is likely to cause harmful interference in which case the user will be required to correct the interference at his own expense.

If you make any modification to the equipment not expressly approved by Intel, you could void your authority to operate the equipment.

Any changes or modifications not expressly approved by the grantee of this device could void the user's authority to operate the equipment. The customer is responsible for ensuring compliance of the modified product.

All cables used to connect to peripherals must be shielded and grounded. Operation with cables, connected to peripherals that are not shielded and grounded may result in interference to radio and TV reception.

#### **1.4.5.2 ICES-003 (Canada)**

This Class A digital apparatus complies with Canadian ICES-003.

Cet appareil numérique de la classe A est conforme à la norme NMB-003 du Canada.

#### **1.4.5.3 CE Declaration of Conformity (Europe)**

We, Intel Corporation, declare under our sole responsibility that the product:

Intel® IIRRZ4CHSI (SRCS14L)

is in conformity with all applicable essential requirements necessary for CE marking, following the provisions of the European Council Directive 89/336/EEC (EMC Directive) and Council Directive 73/23/EEC (Safety/Low Voltage Directive).

The product is properly CE marked demonstrating this conformity and is for distribution within all member states of the EU with no restrictions.



This product follows the provisions of the European Directives 89/336/EEC and 73/23/EEC.

*Dansk* Dette produkt er i overensstemmelse med det europæiske direktiv 89/336/EEC & 73/23/EEC.

*Dutch* Dit product is in navolging van de bepalingen van Europees Directief 89/336/EEC & 73/23/EEC.

*Suomi* Tämä tuote noudattaa EU-direktiivin 89/336/EEC & 73/23/EEC määräyksiä.



*Français* Ce produit est conforme aux exigences de la Directive Européenne 89/336/EEC & 73/23/EEC.

*Deutsch* Dieses Produkt entspricht den Bestimmungen der Europäischen Richtlinie 89/336/EEC & 73/23/EEC.

*Icelandic* Þessi vara stent reglugerð Evrópska Efnahags Bandalagsins númer 89/336/EEC & 73/23/EEC.

*Italiano* Questo prodotto è conforme alla Direttiva Europea 89/336/EEC & 73/23/EEC.

*Norsk* Dette produktet er i henhold til bestemmelsene i det europeiske direktivet 89/336/EEC & 73/23/EEC.

*Portuguese* Este produto cumpre com as normas da Diretiva Europeia 89/336/EEC & 73/23/EEC.

*Español* Este producto cumple con las normas del Directivo Europeo 89/336/EEC & 73/23/EEC.

*Svenska* Denna produkt har tillverkats i enlighet med EG-direktiv 89/336/EEC & 73/23/EEC.

#### 1.4.5.4 **BSMI (Taiwan)**

These products have been tested in accordance to, and complies with Taiwan BSMI certification requirements.

警告使用者:

這是甲類的資訊產品，在居住的環境中使用時，可能會造成射頻干擾，在這種情況下，使用者會被要求採取某些適當的對策。

#### 1.4.5.5 **RRL (Korea)**

These products have been tested in accordance to, and complies with Korean RRL certification requirements.

## 1.5 Warnings and Cautions

This guide and all associated guides in the user documentation set (the Quick Start Guide, the Hardware Guide, and the Software Guide) should be used by qualified technical personnel with experience installing and configuring PCI controllers.

Read and adhere to all warnings, cautions, and notices in this guide and all the guides in the *user documentation set* supplied with this product.

### Warnings

- The connection of a non-shielded equipment interface cable to this equipment will invalidate the FCC certification of this device and may cause interference levels that exceed the limits established by the FCC for this equipment. It is the responsibility of the user to obtain and use a shielded equipment interface cable with this device. If the equipment has more than one interface connector, do not leave cables connected to unused interfaces unless otherwise instructed to do so in the user manual.
- Changes or modifications not expressly approved by the manufacturer could void the user's authority to operate the equipment.

### Cautions

- Take precautions to prevent electrostatic discharge (ESD) damage before handling the IIR controller.
- ESD can damage controller components. Perform the described procedures in this guide only at an ESD workstation. If no such station is available, you can provide some ESD protection by wearing an antistatic wrist strap and attaching it to a metal part of the computer chassis.



# Hardware Installation

# 2

This chapter provides information on installing the IIR controller, programming the Flash memory, setting jumpers, and using the LEDs and alarms to diagnose the controller.

## 2.1 Installation Procedures

**Warning:** Shock hazards may be present inside the computer in which this controller is being installed. Disconnect all power cords to the computer before the removal of any covers.

Follow the warnings noted in your computer's user manual before installing this board. ONLY after reinstallation of all the covers should you reconnect the power cords and power up the computer.

**Note:** Take precautions to prevent electrostatic discharge (ESD) damage before handling the IIR controller.

### 2.1.1 Computer System Hardware Requirements

- Computer with CD-ROM drive
- One available 64-bit/66MHz PCI slot for optimal performance; however, the controller is backwards compatible with all 33MHz PCI expansion slots.
- PCI 2.2 compliant system BIOS

Figure 2-1. IIR Controller Component Layout

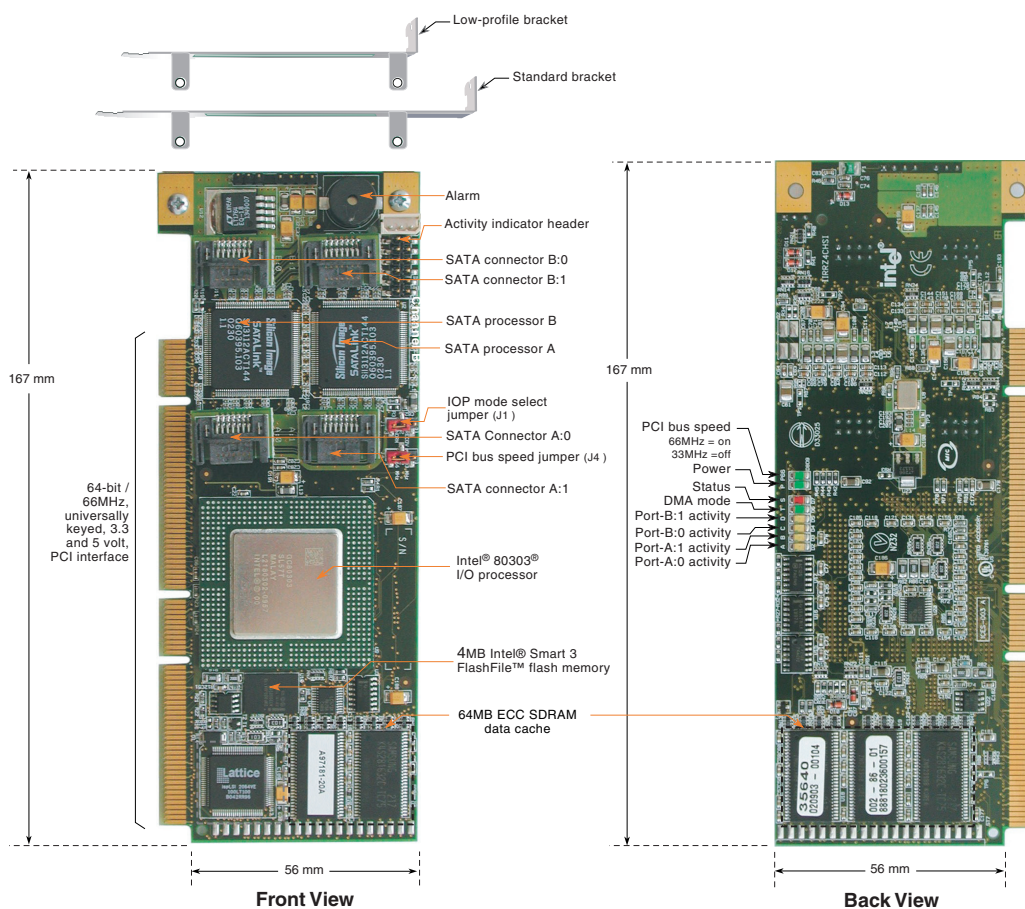

## 2.1.2 Installing the IIR Controller

1. Power-off the computer system.
2. Disconnect power cord(s) and remove the system cover.
3. Install the IIR controller into an available PCI slot. See [Figure 2-2](#).

**Note:** Use the appropriate bracket on the controller for your server platform.

4. Using SATA cables, connect the SATA drives to the internal SATA connectors located on the IIR controller.
5. Replace the system cover and reconnect power cord(s).

**Figure 2-2. Installing the IIR Controller into a Computer System**

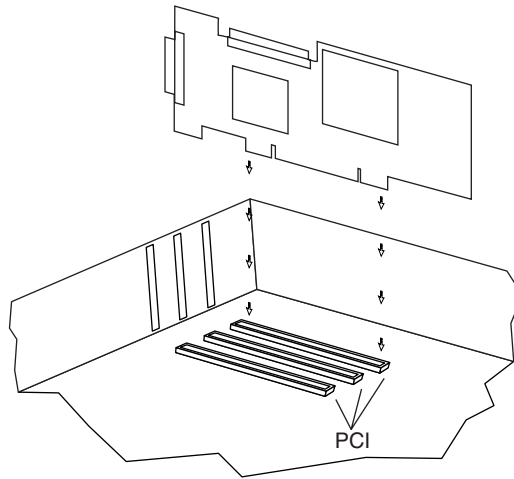

### 2.1.3 Changing Jumper Settings

The IIR controller normally comes ready to be installed into the computer motherboard immediately. However, jumper settings are available to:

- Reprogram the RAID firmware that is located in the flash memory of the IIR controller.
- Set the PCI bus speed (force 33 MHz or auto-negotiate 33/66 MHz).

The board contains 2 jumper blocks to control the functions described in [Table 2-1](#). See [Figure 2-3](#) for jumper locations and pin numbers, and see [Appendix A](#) for a detailed description of jumper J1.

**Figure 2-3. Jumper Locations and Pin Numbers**

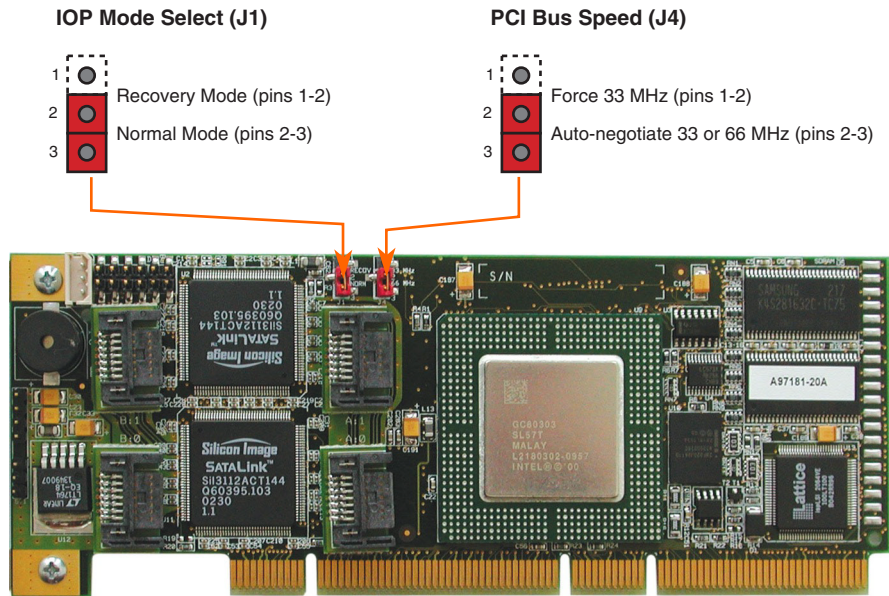



**Table 2-1. Controller Jumper Settings**

Jumper Block	Jumper Position	Definition
J1	Jumper on pins [1-2]	IOP is in reset mode with firmware recovery enabled.
	Jumper on pins [2-3]	IOP is in normal run mode.
	No jumpers	IOP is in normal run mode.
J4	Jumper on pins [1-2]	PCI bus is forced to 33 MHz.
	Jumper on pins [2-3]	PCI bus auto-negotiates 33 MHz or 66 MHz.
	No jumpers	PCI bus auto-negotiates 33 MHz or 66 MHz.

**J1 - IOP mode select jumper block:** This jumper is used to place the IOP in reset, which enables the flash chip to be programmed to recover resident firmware (FW). See [Appendix A](#) for a detailed description of jumper J1.

**J4 - PCI bus speed:** Leave this jumper in the default position (pins 2-3 to auto-negotiate 33/66 Mhz) unless instructed to do otherwise by customer support or a specification update.

## 2.2 Diagnostic Features

The SRCS14L has LED indicators, an 80db audible alarm, and boot-up beep sequences that can help diagnose the controller.

### 2.2.1 LED Indicators

The LEDs on the controller indicate SATA activity, data transfer, power status, PCI bus frequency, and reset mode.

**Figure 2-4. LED Labels and Colors**

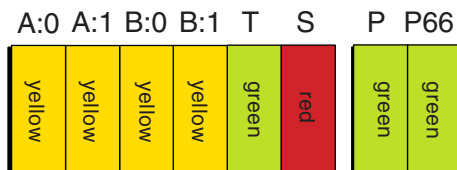

Table 2-2. LED Descriptions

LED	Description
A:0	Indicates activity on SATA port A:0.
A:1	Indicates activity on SATA port A:1.
B:0	Indicates activity on SATA port B:0.
B:1	Indicates activity on SATA port B:1.
T	Indicates data transfer to the controller's cache memory.
S	When illuminated, the controller's IOP is in reset mode.
P	When illuminated, the controller card is powered on.
P66	When illuminated, PCI bus frequency is 66Mhz. When not illuminated, PCI bus frequency is 33Mhz.

## 2.2.2 Audible Alarm

An 80db audible alarm, which is controlled by the RAID firmware, is mounted on the RAID controller to indicate any of the following events:

- State of controller upon boot-up
- Change in the normal state of the array
- Change of controller environmental status (during normal operation)
- Failure of hardware that the controller manages

If the cause of the event is resolved and/or removed, the audible alarm will cease. You can also turn off the audible alarm manually through StorCon or StorCon+. If you use these management tools to silence the alarm, it will only be disabled for the current event and will be ready to sound again at the next event.

### 2.2.2.1 Silencing the Audible Alarm in StorCon

In StorCon, under Advanced Setup > Configure Controller, press <F4> to silence alarm. Note: The <F4> option is only available if the alarm has been activated.

### 2.2.2.2 Silencing the Audible Alarm in StorCon+

In StorCon+, in the *Physical Configuration* view, right click on the icon of the controller requiring alarm deactivation. Click *Silence* to deactivate alarm. If the alarm has not been activated, the *Silence* option will be grayed out.

### 2.2.3 Beep Sequences During System Boot

During system POST, the audible alarm on the controller will produce one of a number of beep sequences to indicate the status of the controller. See [Table 2-3](#) for a description of these beep sequences.

**Table 2-3. Beep Sequences**

Beep Sequence	Status
beep - pause - beep, beep, beep	Controller startup was successful.
beep, beep, beep, beep, ....	RAID controller has a problem. A possible cause is disk failure. To diagnose the problem, run the Storage Console to check the status of the RAID controller and array.
beep, beep - pause - beep, beep - pause - ....	Memory or firmware may have a problem. More details may be available from the boot message. If necessary, recover the firmware by following the procedure in <a href="#">Appendix A, "Flash Memory Programming"</a> .

# Hardware Specifications and Features 3

---

This chapter covers all the hardware specifications associated with the IIR controller and its components. The accompanying *Software Guide* covers all software features.

## 3.1 IIR Controller Hardware Features

This section provides a summary of the key features, configuration options and support interface technology supported by the IIR controller.

### 3.1.1 Key Features

- Supports RAID levels 0, 1, 4, 5 and 10
- Supports up to four hard drives connected to the four SATA ports on the controller
- Online RAID level migration and capacity expansion without reboot
- RAID array roaming
- Instant availability and background initialization
- Automatic rebuild with private (dedicated) or pooled (global) hot fix (spare) drives
- Variable data strip size configurable per array
- 64MB of ECC SDRAM support
- Read/write controller caching
- Hot plug disk drive auto detection configurable for non-intelligent enclosures
- PCI Hot plug support

**Table 3-1. Hardware Architecture**

Component	Features
I/O Microprocessor	The 80303 processor: 100MHz, RISC 64-bit core
Cache Memory	3.3V unbuffered, PC100, ECC SDRAM. 64MB embedded not upgradeable
Flash Memory	3.3v, 32Mb (4MB) flash memory chip is used to store the RAID firmware
I/O interface (PCI)	PCI 2.2 compliant, universally keyed for 3.3 and 5 volt PCI slots
PCI Transfer Rate	528 MB/sec (Burst) DMA to PCI and local buses
PCI Signaling	+5 or +3.3 volt
SATA controllers	Two Silicon Image Sil3112A SATA controllers, which each control two serial ports (four ports total) with speeds up to 1.5 Gbps

**Table 3-2. Environmental Specifications**

<b>Environmental Stress Test</b>	<b>Meets Required Conditions</b>
Operating Temperature	0° C to +55° C
Storage Temperature	-40° C to +70° C
Form Factor (physical dimensions)	Height: 56mm Length: 167mm



## 3.2 Operating System Support

The following operating systems are fully validated and supported:

- Microsoft\* Windows\* XP Professional
- Microsoft Windows 2000 Advanced Server
- Red Hat\* Linux\* 7.3 (2.4 kernel)
- SuSe\* Linux 8.0 Professional

The following operating systems are supported with limited compatibility validation:

- Windows 2000 Server
- Red Hat Linux 7.2
- TurboLinux\* 7.0 Server

## 3.3 Supported Hard Drive Technology

The RAID controller supports up to 4 hard disk drives connected to the 4 SATA ports. These hard drives must be compliant with the SATA specification 1.0.

## 3.4 Array Roaming Compatibility

Array Roaming allows the user the ability to move a complete RAID array from one computer system (for example, computer #1) to another computer system (computer #2) and preserve the RAID configuration information and user data on that RAID array. Computer #2 must also have an SRCS14L controller installed. RAID arrays set up with an SRCS14L controller cannot roam to computers that use other controllers.

**Note:** For a migrated RAID array to be recognized by the new host operating system, the host system may need to be rebooted.

**Warning:** RAID arrays set up with an SRCS14L controller cannot roam to computers that use other controllers (anything other than the SRCS14L). Unpredictable behavior may include, but is not limited to, data loss or corruption.

## 3.5 PCI Hot Plug

The SRCS14L adapter supports PCI Hot Plug under the following OS's:

- Windows 2000 Advanced Server SP2
- Windows 2000 Server

This IIR controller supports the PCI Hot Plug functionality for the hot replacement of an adapter. Hot replacement assumes that the drivers for the adapter being replaced are already loaded.

### 3.6 Hot-Plug Disk Drive Support

This feature allows for the ability to remove and replace drives while I/O activity is taking place, provided that both the hard disk drive and backplane fully support hot-swap, without interruption of operations on any other drives. It supports the hot plug of new drives in non-intelligent enclosures as detailed in [Section 3.7](#).

### 3.7 Auto-detection of Hot-Plug Disk Drives in a Non-Intelligent Drive Enclosure

This feature allows the use of non-intelligent disk enclosures (requires truly hot-pluggable disk drives and backplane connectors) as though they were intelligent enclosures. This feature is configurable and allows the user to set up non-intelligent enclosures to detect the insertion or removal of hot plug disk drives and report the event to the RAID firmware. The RAID configuration is automatically updated to the new configuration. Access this feature through the *Advanced Setup* menu of Storage Console.

### 3.8 RAID Controller Drive Limitations (Host, Array, Logical, and Physical)

The following are limitations assuming the following:

- Four SATA ports
- Cabling that meets SATA specifications 1.0

**Physical drives** are limited by the number of ports (four) on the RAID controller. Each physical drive must be connected to one of the SATA ports. The maximum number of **array drives** is two. A RAID array drive requires a minimum of two hard disk drives (or logical drives). Therefore the maximum RAID array drive limitation for the SRCS14L controller is the physical drive limit divided by two.

Each RAID array drive (up to two) can contain up to a maximum of two **host drives**. This means that the SRCS14L controller has a maximum limitation of four host drives. Also, each array drive must have at least one host drive. A host drive can only be associated with (or reside on) a single array drive.

**Table 3-3. RAID Controller Drive Maximum Limitations (SRCS14L)**

Drive Type	Per RAID Controller	Per Array Drive	Per Host Drive
Physical Disk Drives	4	4	4
RAID Array Drives	2	N/A	1
RAID Host Drives	4	2	N/A

# Flash Memory Programming

# A

## A.1 About Firmware Files

The firmware image that is stored in the flash memory of the RAID controller includes the controller BIOS and the Storage Console (StorCon) software. Refer to the Software Guide for more details about StorCon.

The current firmware file is on the RAID Software Suite CD-ROM. To get the latest firmware for the RAID controller, visit our web site at: <http://support.intel.com>. You can use firmware files to update or recover the firmware image on the controller. See [Section A.2](#) for more information.

Firmware files are in the format SRC\_RXFW.xxx, where the file extension xxx indicates the version stepping. From StorCon or StorCon+, the firmware version is displayed in the format x.yy.zz-A000 (for example, 2.34.00-R02D).

## A.2 Choosing Update vs. Recover

When programming the firmware, you must decide whether an update or a full recovery is more appropriate. If firmware recovery is required, you may need to change a jumper setting. See [Section A.3](#) for details on how to set jumper J1.

**Table A-1. Differences Between Update and Recover**

Symptom or Scenario	Possible Cause	Probability	Suggested Action
New firmware is available on <a href="http://support.intel.com">http://support.intel.com</a> .	A new version of StorCon is available or improvements have been made to the controller BIOS.	Intel provides updates as needed	Update
The controller state is DEFECT when using the FRUU. See <a href="#">Section A.4</a> .	Firmware is damaged.	Rare	Recover
The firmware update procedure was interrupted before successful completion.	Power loss or spike during the update procedure.	Rare	Recover

## A.3 Setting Jumper J1

The J1 jumper must be set for flash recovery mode (pins 1-2) to recover the firmware. For all other operations, including firmware update, normal mode (pins 2-3) is required. See [Figure 2-1](#) for the jumper location and [Figure A-1](#) below for jumper positions.



Refer to [Section A.2](#) for help in deciding whether the firmware needs a recovery or update.

**Figure A-1. Jumper Positions for Flash Update and Recovery**

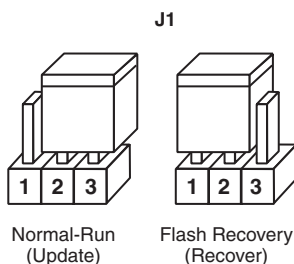

**Warning:** Shock hazards may be present inside the unit in which this controller is being installed. Disconnect all power cords to the unit before removal of any covers. Follow the warnings noted in your computer's user or service manual before installing this board. ONLY after all the covers are reinstalled should you reconnect the power cords and power up the unit.

1. Take all precautions to prevent ESD damage before handling the IIR controller.
2. Power off all system components and disconnect their power cords.
3. Remove the cover from the system to gain access to the PCI slots.
4. Remove the IIR controller from your system.
5. On jumper block J1, move the jumper to position 1-2 for firmware updates or to position 2-3 for firmware recovery. See [Figure A-1](#) and [Figure 2-1](#) for details.
6. Re-install the adapter in the PCI slot in which it was previously installed.
7. Replace the cover, reconnect all power cords and power up the system.

## A.4 Updating or Recovering Firmware Using the FRUU

This section explains how to use the Firmware Recovery and Update Utility (FRUU) to update or recover the firmware on the RAID controller. For help in choosing between update and recover, see [Section A.2](#).

The FRUU is available from these locations:

**Table A-2. FRUU Locations and Descriptions**

FRUU Location	Summary	More Information
Run the FRUU on diskettes created from: <ul style="list-style-type: none"> <li>• The Windows autorun menu of the RAID Software Suite CD-ROM</li> <li style="text-align: center;">OR</li> <li>• The 'Create Diskettes' option from the bootable CD</li> </ul>	Create the two diskettes described below and then boot the computer with diskette 1: <ul style="list-style-type: none"> <li>• <b>Diskette 1</b>—The bootable Firmware Recovery and Update Utility (FRUU).</li> <li>• <b>Diskette 2</b>—The firmware file. You can:               <ul style="list-style-type: none"> <li>— Create the firmware diskette from the firmware file that is on the CD-ROM.</li> <li style="text-align: center;">OR</li> <li>— Download the latest firmware file from <a href="http://support.intel.com">http://support.intel.com</a>.</li> </ul> </li> </ul>	<ul style="list-style-type: none"> <li>• See <a href="#">Section A.4.1</a> to create the diskettes from the Windows autorun menu.</li> <li>• See <a href="#">Section A.4.2</a> to create the diskettes from the Bootable RAID Software Suite CD-ROM.</li> <li>• See <a href="#">Section A.4.3</a> for information on running the FRUU.</li> </ul>
Run the FRUU directly from the bootable RAID Software Suite CD-ROM	Boot directly from the RAID Software Suite CD-ROM to update or recover the firmware image on the controller with the original firmware file that shipped on the CD.	See <a href="#">Section A.4.3</a> for information on running the FRUU.

## A.4.1 Creating Firmware Diskettes from the CD-ROM Autorun Menu

1. Insert the RAID Software Suite CD-ROM into a Windows computer.
2. After the Main Menu loads automatically, click 'Utility Diskettes.'
3. Click 'Firmware Recovery Utility.' A DOS window will display prompting you to insert a blank floppy diskette.
4. Insert the blank diskette, then press Enter.
5. After the file transfer is complete, remove the diskette from the computer and label it.
6. Insert a second blank diskette into the computer.
7. Download the latest firmware file from <http://support.intel.com> and copy it to the second floppy diskette. Proceed to [Section A.4.3](#) for information on running the FRUU.

OR

Click Firmware Diskette to get the firmware file from the RAID Software Suite CD-ROM, then complete the remaining steps in this procedure.

8. Click 'Firmware Diskette.' A DOS window will display prompting you to insert a blank floppy diskette.
9. Verify that a blank diskette is inserted, then press Enter.

10. After the file transfer is complete, remove the firmware diskette from the computer and label it.

#### **A.4.2 Creating Firmware Diskettes from the Bootable RAID Software Suite CD-ROM**

1. If necessary, change your computer's BIOS setting so that the system boots from the CD-ROM.
2. Boot the computer from the RAID Software Suite CD-ROM.
3. Select 'Create Diskettes' and press Enter.
4. Select 'Firmware Diskettes' and press Enter.
5. Select 'Bootable Firmware Recovery Floppy' and press Enter.
6. Insert a blank floppy Diskette, then select 'Yes' and press Enter to begin the file transfer.
7. After the file transfer is complete, select 'OK', then press Enter.
8. Remove the first diskette and label it.
9. From a computer that has an internet connection, download the latest firmware file from <http://support.intel.com> and copy it to a second floppy diskette. Proceed to [Section A.4.3](#) for information on running the FRUU.

OR

Insert a second blank diskette into the computer, then complete the remaining steps in this procedure.

10. Select 'Create Diskettes' and press Enter.
11. Select 'Firmware Diskettes' and press Enter.
12. Select 'Firmware File' and press Enter.
13. Verify that your second blank floppy Diskette is inserted, then select 'Yes' and press Enter to begin the file transfer.
14. After the file transfer is complete, select 'OK', then press Enter.
15. Remove the first diskette and label it.
16. Proceed to [Section A.4.3](#) for information on running the FRUU.

#### **A.4.3 Running the FRUU**

1. Choose between firmware update and firmware recovery. See [Section A.2](#).
2. Set the IIR controller's IOP to normal for firmware updates or to reset for firmware recovery. See [Section A.3](#).
3. If running the FRUU from the RAID Software Suite CD-ROM, change your computer's BIOS setting so that your system boots from the CD-ROM.



4. Insert the RAID Software Suite CD-ROM.

OR

Insert the bootable FRUU floppy.

5. Boot the computer.
6. If booting from the RAID Software Suite CD-ROM, select Firmware Management from the Main Menu and press <Enter>.

OR

If booting from the FRUU bootable floppy diskette, insert the second firmware diskette after the computer finishes booting from the first diskette, then select “Y” (for Yes) and press Enter to load the firmware file.

7. View the summary information on the screen. The Flash Recovery and Update Utility detects any RAID controllers and lists them in the order that they are found.

**Note:** Notice the STATE column in this screen. The state of each controller is **NORMAL** (the word is green if booting from CD), **RESET** (the word is red if booting from CD), or **DEFECT** (the word is red if booting from CD).

- **If the controller state is NORMAL**—You can perform a firmware update. If you need to perform a firmware recovery, shut down the system and start again with [step 4](#) above. Refer to [Section A.3](#) to set the jumper in reset mode.
  - **If the controller state is RESET**—You can perform a firmware recovery. If you only need to perform a firmware update, shut down the system and start again with [step 4](#) above. Refer to [Section A.3](#) to set the jumper in normal mode.
  - **If the controller state is DEFECT**—You must perform a firmware recovery.
8. Type a controller number to start the update or recovery process for the firmware on that controller. You do not need to press Enter after typing the number. You will see messages showing the progress of the firmware update or recovery. The entire process may take several minutes.
  9. If necessary, reset the jumper to normal mode.
    - a. Power off all system components and disconnect power cords.
    - b. Remove the system cover.
    - c. Remove the IIR controller from your system.
    - d. On Jumper block J1, move the jumper from position 1-2 to position 2-3 (see [Section A.3](#)). Reinstall the IIR controller in the PCI slot in which it was previously installed. Reconnect the SATA drives to the controller.
    - e. Replace the cover, reconnect all power cords and power up the system.
  10. Change your computer’s system BIOS setting so that your system boots normally (not from the CD-ROM).

## A.5 Updating Firmware Using XROM StorCon

There are two options for updating the firmware, BIOS and XROM StorCon currently programmed on the flash memory of the RAID controller:

- Use the Storage Console (StorCon) to update the firmware image as explained in this section.
- Run the Firmware Recovery and Update Utility (FRUU) from a bootable CD or diskette as explained in [Section A.4](#).

You cannot use StorCon to recover the firmware, but you can use it to update the firmware. For information about update vs. recover, see [Section A.2](#).

**Note:** The Firmware Update option is not available when StorCon is accessing the RAID Controller remotely.

### To Update the Firmware with StorCon

1. Download the firmware image containing the latest programs/drivers from the website. Format a 3.5" HD disk (1.44MB) and copy the firmware file onto the disk.
2. With the adapter installed in the system, boot the computer and press <Ctrl>+<G> when prompted to enter the BIOS version of StorCon.
3. Select the applicable RAID controller and press <Enter>.
4. If the Express Setup menu is displayed, press <F4> to display the Advanced Setup menu. Select the menu option, Configure Controller and press <Enter>. Insert the floppy containing the latest firmware file into the floppy disk drive.
5. From the Configure Controller submenu, select Firmware Update and press <Enter>.
6. XROM StorCon automatically searches for the firmware file from the floppy drive, a:\. After finding the file, StorCon displays the name, description and version of the firmware. Press <Enter>.
7. StorCon reads and checks the firmware file, then displays a warning. Press <Y> to confirm the firmware update.
8. StorCon programs the flash eeprom.

**Warning:** Do not interrupt the update process to avoid damaging the firmware image in the Flash. If the firmware is interrupted you will need to follow the firmware recovery process in the next section.

After StorCon indicates that the update is complete, press any key.

9. The focus returns to the Configure Controller submenu. Press <Esc> several times to close the menus and press <Y> to quit StorCon.
10. StorCon detects the firmware update and requires a system reboot. Press any key to reboot.

When the update process has completed, reboot the computer for the change to take effect. During boot up, the system displays the updated firmware version. You can also relaunch StorCon and select the applicable RAID controller to view its new firmware version at the bottom of the console (for example, FW:2.34.yy-Rzzz).



You can also use the OS version of StorCon to update the firmware. Refer to the Storage Console chapter of the Software Guide for more details.

## Index

---

### A

- adapter hardware
  - architecture features 20
  - system requirements 13

### I

- installation
  - raid adapter 14
  - warnings and cautions 11

### R

- raid adapter
  - hardware features 20
  - hardware requirements 13
  - installation 14
  - intallation procedures 13
  - system requirements 13

### S

- system requirements
  - hardware 13

### U

- user's manual
  - intended audience 5

### W

- warnings and cautions 11