

# Intel<sup>®</sup> Entry Storage System SS4000-E User Guide

---

**A Guide for Technically Qualified Assemblers of Intel<sup>®</sup> Identified Subassemblies/  
Products**

Intel Order Number D39172-005

## **Disclaimer**

Information in this document is provided in connection with Intel® products. No license, express or implied, by estoppel or otherwise, to any intellectual property rights is granted by this document. Except as provided in Intel's Terms and Conditions of Sale for such products, Intel assumes no liability whatsoever, and Intel disclaims any express or implied warranty, relating to sale and/or use of Intel® products including liability or warranties relating to fitness for a particular purpose, merchantability, or infringement of any patent, copyright or other intellectual property right. Intel products are not designed, intended or authorized for use in any medical, life saving, or life sustaining applications or for any other application in which the failure of the Intel product could create a situation where personal injury or death may occur. Intel may make changes to specifications and product descriptions at any time, without notice.

Intel® server boards contain a number of high-density VLSI and power delivery components that need adequate airflow for cooling. Intel's own chassis are designed and tested to meet the intended thermal requirements of these components when the fully integrated system is used together. It is the responsibility of the system integrator that chooses not to use Intel developed server building blocks to consult vendor datasheets and operating parameters to determine the amount of airflow required for their specific application and environmental conditions. Intel Corporation can not be held responsible if components fail or the server board does not operate correctly when used outside any of their published operating or non-operating limits.

Intel, Intel Pentium, and Intel Xeon are trademarks or registered trademarks of Intel Corporation or its subsidiaries in the United States and other countries.

\* Other names and brands may be claimed as the property of others.

Copyright © 2006-2007, Intel Corporation. All Rights Reserved

# Safety Information

---

## Important Safety Instructions

Read all caution and safety statements in this document before performing any of the instructions. See also Intel Server Boards and Server Chassis Safety Information on the *Intel® Server Deployment Toolkit CD* and/or at <http://support.intel.com/support/motherboards/server/sb/cs-010770.htm>.

## Wichtige Sicherheitshinweise

Lesen Sie zunächst sämtliche Warnung und Sicherheitshinweise in diesem Dokument, bevor Sie eine der Anweisungen ausführen. Beachten Sie hierzu auch die Sicherheitshinweise zu Intel-Serverplatinen und Servergehäusen auf der *Intel® Server Deployment Toolkit CD* oder unter <http://support.intel.com/support/motherboards/server/sb/cs-010770.htm>.

## Consignes de sécurité

Lisez attention toutes les consignes de sécurité et les mises en garde indiquées dans ce document avant de suivre toute instruction. Consultez Intel Server Boards and Server Chassis Safety Information sur le *Intel® Server Deployment Toolkit CD* ou bien rendez-vous sur le site <http://support.intel.com/support/motherboards/server/sb/cs-010770.htm>.

## Instrucciones de seguridad importantes

Lea todas las declaraciones de seguridad y precaución de este documento antes de realizar cualquiera de las instrucciones. Vea Intel Server Boards and Server Chassis Safety Information en el *Intel® Server Deployment Toolkit CD* y/o en <http://support.intel.com/support/motherboards/server/sb/cs-010770.htm>.

### 重要安全指导

在执行任何指令之前，请阅读本文档中的所有注意事项及安全声明。和/或 <http://support.intel.com/support/motherboards/server/sb/cs-010770.htm> 上的 Intel Server Boards and Server Chassis Safety Information (《Intel 服务器主板与服务器机箱安全信息》)。

## Warnings

These warnings and cautions apply whenever you remove the enclosure cover to access components inside the storage system. Only a technically qualified person should maintain or configure the storage system.

**Heed safety instructions:** Before working with your server product, whether you are using this guide or any other resource as a reference, pay close attention to the safety instructions. You must adhere to the assembly instructions in this guide to ensure and maintain compliance with existing product certifications and approvals. Use only the described, regulated components specified in this guide. Use of other products / components void the UL listing and other regulatory approvals of the product and most likely result in noncompliance with product regulations in the region(s) in which the product is sold.

**System power on/off:** The power button DOES NOT turn off the system AC power. To remove power from storage system, you must unplug the AC power cord from the wall outlet or the chassis. Make sure the AC power cord is unplugged before you open the chassis, add, or remove any components.

**Hazardous conditions, devices and cables:** Hazardous electrical conditions may be present on power, telephone, and communication cables. Turn off the storage system and disconnect the power cord, telecommunications systems, networks, and modems attached to the storage system before opening it. Otherwise, personal injury or equipment damage can result.

**Electrostatic discharge (ESD) and ESD protection:** ESD can damage disk drives, boards, and other parts. We recommend that you perform all procedures in this document only at an ESD workstation. If one is not available, provide some ESD protection by wearing an anti-static wrist strap attached to a chassis ground of any unpainted metal surface on your storage system when handling parts.

**ESD and handling boards:** Always handle boards carefully. They can be extremely sensitive to ESD. Hold boards only by their edges. Do not touch the connector contacts. After removing a board from its protective wrapper or from the storage server, place the board component side up on a grounded, static-free surface. Use a conductive foam pad if available but not the board wrapper. Do not slide board over any surface.

**Installing or removing jumpers:** A jumper is a small plastic encased conductor that slips over two jumper pins. Some jumpers have a small tab on top that you can grip with your fingertips or with a pair of fine needle nosed pliers. If your jumpers do not have such a tab, take care when using needle nosed pliers to remove or install a jumper; grip the narrow sides of the jumper with the pliers, never the wide sides. Gripping the wide sides can damage the contacts inside the jumper, causing intermittent problems with the function controlled by that jumper. Take care to grip with, but not squeeze, the pliers or other tool you use to remove a jumper, or you may bend or break the pins on the board.

**Reinstalling enclosure cover:** For proper cooling and airflow, always install the enclosure cover before turning on the storage system. Operating it without the enclosure cover in place can damage system parts.

# Preface

---

## About this Manual

Thank you for purchasing and using the Intel® Entry Storage System SS4000-E.

This manual is written for system technicians who are responsible for troubleshooting, upgrading, and repairing this storage system. This document provides a brief overview of the features of the product, a list of accessories or other components you may need, troubleshooting information, and instructions on how to add and replace components on the Intel® Entry Storage System SS4000-E. For the latest version of this manual, see <http://support.intel.com/support/motherboards/server/ss4000-e/>.

## Manual Organization

Chapter 1 provides a brief overview of the Intel® Entry Storage System SS4000-E. In this chapter, you find a list of the storage system's features, photos of the product, and product diagrams to help you identify components and their locations.

Chapter 2 provides instructions on adding and replacing components. Use this chapter for step-by-step instructions and diagrams for installing or replacing components such as the fans, power supply, drives, and other components.

Chapter 3 provides information on managing your system. This chapter explains how to manage users, create shared folders, and perform other tasks for configuring and managing your storage system.

Chapter 4 provides information on the Intel® Client Backup and Recovery software used to protect your local disks on client machines.

At the back of this book, you find technical specifications, regulatory information, safety information, “getting help” information, and warranty information.

## Product Contents, Order Options, and Accessories

Your storage system ships with the following items:

- Intel® Entry Storage System SS4000-E
- Attention document, in the product box
- Intel® Entry Storage System SS4000-E *Quick Start User's Guide*, in the product box
- AC power cord (North America only)
- One RJ-45 Ethernet cable

- Software CD, containing the Intel® Client Backup and Recovery software and product documentation
- Recovery CD
- Set of hard disk labels

In addition, you may need or want to purchase the following accessory item for your storage system:

- Hard drives

For information about which accessories, memory, and third-party hardware have been tested and can be used with your storage system, and for ordering information for Intel® products, see <http://support.intel.com/support/motherboards/server/ss4000-e/compat.htm>.

## Additional Information and Software

If you need more information about this product or information about the accessories that can be used with this storage system, use the following resources. These files are available at <http://support.intel.com/support/motherboards/server/ss4000-e/>

Unless otherwise indicated in the following table, once on this Web page, type the document or software name in the search field at the left side of the screen and select the option to search “This Product.”

<b>For this information or software</b>	<b>Use this Document or Software</b>
For in-depth technical information about this product	Intel® Entry Storage System SS4000-E <i>Technical Product Specification</i> <a href="http://support.intel.com/support/motherboards/server/ss4000-e/">http://support.intel.com/support/motherboards/server/ss4000-e/</a>
If you just received this product and need to install it	Intel® Entry Storage System SS4000-E <i>Quick Start User's Guide</i> in the product box
For virtual system tours and interactive repair information	A link to the SMaRT Tool is available under “Other Resources” at the right side of the screen at <a href="http://support.intel.com/support/motherboards/server/ss4000-e/">http://support.intel.com/support/motherboards/server/ss4000-e/</a>
Accessories or other Intel server products	Spares and Configuration Guide
Hardware and operating systems that have been validated by Intel for this product	Tested Hardware and Operating Systems List <a href="http://support.intel.com/support/motherboards/server/ss4000-e/">http://support.intel.com/support/motherboards/server/ss4000-e/</a>

# Contents

---

<b>Safety Information</b> .....	<b>iii</b>
Important Safety Instructions .....	iii
Wichtige Sicherheitshinweise .....	iii
Consignes de sécurité .....	iii
Instrucciones de seguridad importantes .....	iii
Warnings.....	iv
<b>Preface</b> .....	<b>v</b>
About this Manual .....	v
Manual Organization .....	v
Product Contents, Order Options, and Accessories .....	v
Additional Information and Software .....	vi
<b>Storage System Features</b> .....	<b>1</b>
Key Features and Benefits .....	2
Front Panel .....	3
Rear Panel .....	5
System Requirements .....	6
Accessories and Spare Parts .....	7
<b>Getting Started</b> .....	<b>9</b>
Setting up the Storage System .....	10
Installing the Hard Disks .....	10
Attaching the Storage System to the Network .....	15
Powering Up the Storage System .....	16
Powering Down the Storage System .....	16
Initializing your Storage System .....	16
Installing the Console .....	17
Starting the Console .....	18
Initializing the Disks .....	20
Configuring Your Storage System .....	21
Accessing the Manager .....	25
Accessing the Manager Using the Console .....	26
Accessing the Manager Using a Web Browser .....	26
Logging in to the Manager.....	27
Navigating the Manager.....	28
Viewing Information About Your Storage System .....	30
Adding Users .....	32
Creating Shared Folders .....	35
Managing Shared Folders .....	36
Deleting a Shared Folder .....	37

## Contents

Assigning Users to Shared Folders .....	38
<b>Managing Your Storage System .....</b>	<b>39</b>
Managing Users .....	40
Adding Users .....	41
Modifying Users .....	41
Removing Users .....	43
Working with Groups .....	43
Synchronizing the Storage System and Active Directory Server .....	54
Managing Shared Folders .....	54
Deleting a Shared Folder .....	55
Assigning Users to Shared Folders .....	56
Managing Backups .....	58
Changing the Recovery Password .....	59
Configuring Remote Boot .....	59
Deleting a Backup .....	60
Deleting a Client .....	61
Setting Up e-mail Alerts.....	62
Upgrading the Firmware.....	64
Disconnecting USB Devices.....	65
Changing the System Settings.....	66
Changing the Network Settings.....	68
Reconfiguring Your Storage System Disks .....	71
Expanding the Shared Storage .....	72
Reconfiguring the Disks .....	73
Viewing System Status Information .....	76
Logging Out of the Manager.....	77
Shutting Down the Storage System .....	77
<b>Working with Shared Folders .....</b>	<b>79</b>
Accessing Shared Folders .....	79
Microsoft Windows* Users .....	79
Linux* Users .....	84
Mac Users .....	84
Accessing Shared Folders using FTP .....	85
Disconnecting from Shared Folders .....	86
Microsoft Windows* Users .....	86
Linux* Users .....	87
Mac* Users .....	87
<b>Protecting Local Disks .....</b>	<b>89</b>
Getting Started .....	90
System Requirements .....	90
Additional Requirements .....	91
Installing the Microsoft iSCSI Initiator* .....	91
Installing Intel® Client Backup and Recovery .....	92



Starting Intel® Client Backup and Recovery .....	95
Activating Your License .....	96
Activating Your License Without an Internet Connection .....	97
Replacing Your Existing License .....	98
Protecting Your Disks .....	98
Manually Backing up Your Disk .....	105
Stopping a Backup or Recovery in Progress .....	106
Changing the Backup Schedule .....	107
Receiving Event Notifications .....	108
Changing the Recovery Password .....	108
Enabling or Disabling Remote Boot .....	110
Enabling Remote Boot .....	111
Disabling Remote Boot .....	112
Recovering Data .....	112
Recovering Files or Folders .....	114
Recovering a Data Disk .....	116
Recovering a System Disk Using the Recovery CD .....	117
Recovering a System Disk While Booting Remotely .....	122
Removing Protection .....	126
<b>Adding or Replacing Hard Disks .....</b>	<b>127</b>
Adding Hard Disks .....	127
Adding Hard Disks to a Linear or Normal RAID Configuration .....	128
Adding Hard Disks to a Degraded RAID Configuration .....	130
Removing Hard Disks or Responding to a Disk Failure.....	131
Responding to RAID Degradation .....	132
Responding to RAID Failure .....	133
Swapping Hard Disks .....	134
Transferring Hard Disks to a New Storage System .....	134
<b>Hardware Installations and Upgrades .....</b>	<b>137</b>
Before You Begin .....	137
Tools and Supplies Needed .....	137
System References .....	137
Removing or Installing the Enclosure Cover .....	137
Removing the Enclosure Cover .....	138
Installing the Enclosure Cover.....	139
Replacing or Installing a Hard Disk.....	140
Replacing Power Supply .....	145
Replacing System Fan.....	151
<b>Troubleshooting .....</b>	<b>159</b>
Viewing the System Log .....	159
Troubleshooting the Storage System .....	160
Troubleshooting Intel® Client Backup and Recovery .....	162
Creating a Diagnostic File.....	165

## Contents

Using Intel® Client Backup and Recovery .....	165
Using the Recovery CD .....	165
Resetting the Recovery Password in the Microsoft iSCSI Initiator* .....	166
<b>Technical Specifications .....</b>	<b>167</b>
Hardware Specification .....	167
Software Specification.....	168
<b>A Levels of RAID .....</b>	<b>169</b>
Linear .....	169
RAID 0 - Data Striping .....	169
RAID 1 - Disk Mirroring/Disk Duplexing .....	170
RAID 5 - Data Striping with Striped Parity .....	170
RAID 5 + Spare .....	171
RAID 10 - Combination of RAID 1 and RAID 0 .....	172
<b>B PXE Remote Boot .....</b>	<b>173</b>
<b>C Glossary .....</b>	<b>175</b>
<b>D Regulatory and Compliance Information .....</b>	<b>177</b>
Product Regulatory Compliance .....	177
Intended Application .....	177
Product Safety Compliance .....	177
Product EMC Compliance - Class B Compliance .....	178
Certifications / Registrations / Declarations .....	178
Product Regulatory Compliance Markings .....	179
Electromagnetic Compatibility Notices .....	180
FCC Statement (USA) .....	180
ICES-003 (Canada) .....	180
Europe (CE Declaration of Conformity) .....	181
VCCI (Japan) .....	181
BSMI (Taiwan) .....	181
RRL (Korea) .....	181
End of Life / Product Recycling .....	182
Restriction of Hazardous Substances (RoHS) Compliance .....	182
<b>E Warranty .....</b>	<b>183</b>
Limited Warranty for Intel® Chassis Subassembly Products .....	183
Extent of Limited Warranty .....	183
Warranty Limitations and Exclusions .....	184
Limitations of Liability .....	184
How to Obtain Warranty Service .....	184
Telephone Support .....	185
Returning a Defective Product .....	185
<b>F Getting Help .....</b>	<b>187</b>
World Wide Web .....	187

Telephone .....	187
U.S. and Canada .....	187
Europe .....	187
In Asia-Pacific region .....	188
Japan .....	188
Latin America .....	188
<b>G Installation/Assembly Safety Instructions .....</b>	<b>191</b>
English .....	191
Deutsch .....	193
Français .....	196
Español .....	198
Italiano .....	200
<b>H Safety Information .....</b>	<b>203</b>
English .....	203
Server Safety Information .....	203
Safety Warnings and Cautions .....	203
Intended Application Uses .....	204
Site Selection .....	204
Equipment Handling Practices .....	204
Power and Electrical Warnings .....	204
System Access Warnings .....	205
Rack Mount Warnings .....	206
Electrostatic Discharge (ESD) .....	206
Other Hazards .....	207
Deutsch.....	208
Sicherheitshinweise für den Server .....	208
Sicherheitshinweise und Vorsichtsmaßnahmen .....	208
Zielbenutzer der Anwendung .....	209
Standortauswahl .....	209
Handhabung von Geräten .....	209
Warnhinweise für den Systemzugang .....	211
Elektrostatische Entladungen (ESD) .....	212
Andere Gefahren .....	213
Français .....	214
Consignes de sécurité sur le serveur .....	214
Sécurité: avertissements et mises en garde .....	214
Domaines d'utilisation prévus .....	215
Sélection d'un emplacement .....	215
Pratiques de manipulation de l'équipement .....	215
Décharges électrostatiques (ESD) .....	218
Autres risques .....	219
Español.....	220
Información de seguridad del servidor .....	220
Advertencias y precauciones sobre seguridad .....	220
Aplicaciones y usos previstos .....	221

## Contents

Selección de la ubicación .....	221
Manipulación del equipo .....	221
Advertencias el acceso al sistema .....	223
Descarga electrostática (ESD) .....	224

# List of Tables

---

Table 1. Component Definitions .....	4
Table 2. Rear Panel LEDs and Components .....	6
Table 3. System Requirements .....	6
Table 4. Accessories and Spare Parts Descriptions .....	7
Table 5. Hardware Specifications.....	167
Table 6. Software Component Specifications .....	168

**This page intentionally left blank.**

# List of Figures

---

Figure 1. Intel® Entry Storage System SS4000-E - Front View.....	1
Figure 2. Front Panel LEDs and Components .....	3
Figure 3. Rear Panel Components.....	5
Figure 4. Removing Drive Carrier from Storage System.....	11
Figure 5. Removing Baffle from Drive Carrier .....	11
Figure 6. Rear View of SATA Hard Disk .....	12
Figure 7. Installing Hard Disk into Drive Carrier .....	12
Figure 8. Applying Label to Hard Disk.....	13
Figure 9. Order of Drive Carriers.....	13
Figure 10. Re-installing Drive Carrier into Storage System.....	14
Figure 11. Connecting Storage System to Network .....	15
Figure 12. Powering up the Storage System.....	16
Figure 13. Removing Enclosure Cover .....	138
Figure 14. Installing Enclosure Cover .....	139
Figure 15. Removing Drive Carrier from Storage System.....	141
Figure 16. Removing Baffle from Drive Carrier .....	141
Figure 17. Rear View of SATA Hard Disk .....	142
Figure 18. Installing Hard Disk into Drive Carrier .....	142
Figure 19. Affixing Label to Drive Carrier .....	143
Figure 20. Order of Drive Carriers.....	143
Figure 21. Re-installing Drive Carrier into Storage System.....	144
Figure 22. Removing Enclosure Cover .....	146
Figure 23. Detaching Power Supply from Chassis.....	147
Figure 24. Disconnecting Power Cables and Removing Power Supply Cage .....	147
Figure 25. Removing Gasket from Old Power Supply.....	148
Figure 26. Installing Gasket on New Power Supply .....	148
Figure 27. Installing New Power Supply Cage .....	149
Figure 28. Securing New Power Supply Cage to Chassis .....	149
Figure 29. Installing Enclosure Cover .....	150
Figure 30. Removing Enclosure Cover .....	151
Figure 31. Removing Drive Carriers.....	152
Figure 32. Removing Backplane from Chassis .....	153
Figure 33. Removing System Fan.....	154
Figure 34. Installing New System Fan.....	155
Figure 35. Re-installing Backplane Assembly .....	156
Figure 36. Re-installing Drive Carriers .....	157
Figure 37. Installing Enclosure Cover .....	158
Figure 38. RAID 0 - Data Striping.....	169
Figure 39. RAID 1 - Disk Mirroring/Disk Duplexing .....	170
Figure 40. RAID 5 - Data Striping with Striped Parity.....	171
Figure 41. RAID 5 + Spare.....	171
Figure 42. RAID 10 - Combination of RAID 1 and RAID 0 .....	172

*List of Figures*



# 1 Storage System Features

---

The Intel® Entry Storage System SS4000-E is an intelligent network storage solution for small and medium-sized offices, and home network environments. It provides up to 3.0 TB of hard disk space for both shared files and backups of your computer hard disks, offering an ideal way to distribute and protect important data.

The storage system features an integrated file server with system backup, and ability to manage shared folders by user names or groups. It can connect to a gigabit Ethernet network and support up to four serial ATA (SATA) hard drives. The storage system's performance is ideal for protecting company data and quickly restoring files from a backup.

To make it easy to back up your computer hard disks, the storage system includes Intel® Client Backup and Recovery, a software application that provides reliable data protection and rapid data recovery in the event of a system crash or disk failure. With Intel® Client Backup and Recovery, you can recover your local disks or partitions without having to reinstall or reconfigure the operating system or applications, dramatically shortening recovery time. One key code is included with the system. Additional key codes can be purchased from <http://www.intel.com/design/servers/storage/offers>.

Figure 1 shows a front view of the Intel® Entry Storage System SS4000-E.



TP000086

**Figure 1. Intel® Entry Storage System SS4000-E - Front View**

## Key Features and Benefits

- **Flexible storage capacity:** The Intel<sup>®</sup> Entry Storage System SS4000-E supports up to four 3.5-inch SATA hard disks. You can start with one hard disk and add more as your needs grow. See the *Tested Hardware and Operating Systems List* at <http://support.intel.com/support/motherboards/server/ss4000-e/> for a list of compatible operating systems and hard drives.
- **Built-in data protection:** In addition to a linear disk configuration in which all the disks are treated as independent entities, the storage system supports several different types of RAIDs (redundant arrays of independent disks). This means that you can take advantage of the built-in data protection and data duplication offered by advanced RAID levels. If your storage system has multiple hard drives and one fails, you won't lose important data. For more information, see [Appendix A, "Levels of RAID"](#).

*Caution:* RAID 0 and linear disk configurations do not offer any data protection. If you lose a hard disk, data loss occurs.

- **Simple administration:** You can run the browser-based management interface from any computer in your network, and its informative wizards and configuration pages help you accomplish your tasks quickly and easily.
- **Storage and Connection Status:** The **HOME** page of the management interface lets you quickly determine how much space is being used and who currently is connected.
- **Support for file sharing on multiple platforms:** Whether the computers in your network run Microsoft Windows\*, a Mac\* OS X or other Mac operating system, or Linux\*, you can set up file-sharing for each of them.
- **Security:** Only authorized users can access the shared folders on your storage system. You can also control whether the user can only view the information in the shared folders or also add, modify, or delete files there.
- **USB support:** Additional USB storage devices may be attached to the USB ports.
- **Client backup:** Provides reliable data protection and rapid data recovery in case of a system crash or hard drive failure.
- **Active Directory Support:** The storage system can import user and group lists automatically making it easier to manage access to the system.

# Front Panel

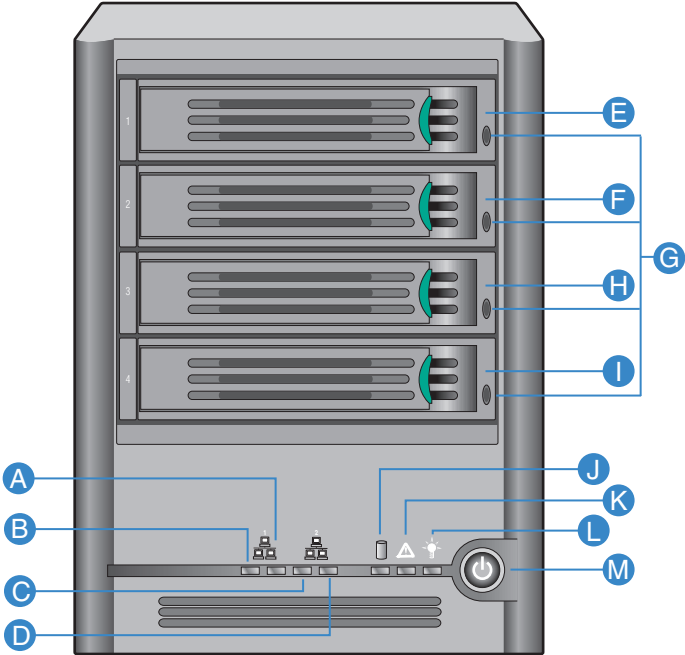

AF000085

Figure 2. Front Panel LEDs and Components

**Table 1. Component Definitions**

<b>Call out</b>	<b>Component</b>	<b>Definition</b>
A	NIC 1 Activity LED	Blinking GREEN indicates Ethernet activity.
B	NIC 1 Link LED	Continuous GREEN indicates an active Ethernet connection. Off indicated no active Ethernet connection.
C	NIC 2 Link LED	Blinking GREEN indicates Ethernet activity.
D	NIC 2 Activity LED	Continuous GREEN indicates an active Ethernet connection. Off indicated no active Ethernet connection.
E	Drive Carrier - 1	3.5-in SATA drive carrier
F	Drive Carrier - 2	3.5-in SATA drive carrier
G	Hard Disk Activity LED Light Pipe	Continuous GREEN indicates the drive is available. Blinking GREEN indicates drive activity. Continuous YELLOW indicates a fault condition, possibly requiring the hard disk to be replaced. Blinking YELLOW indicates the drive is currently rebuilding RAID.
H	Drive Carrier - 3	3.5-in SATA drive carrier
I	Drive Carrier - 4	3.5-in SATA drive carrier
J	Global Disk Status LED	Continuous GREEN indicates hard disk health is good (1-4 hard disks). Continuous YELLOW indicates a critical or non-recoverable condition exists. It also indicates the hard drives are not configured when initially setting up the system. Blinking YELLOW indicates one or more hard disks are experiencing a fault condition or a RAID is being rebuilt.
K	System Status LED	Continuous GREEN indicates the system is running and operating normally. Blinking GREEN indicates the system is in process of powering up or shutting down. Continuous YELLOW indicates a fault is present, either a critical or non-recoverable condition.
L	Power LED	Continuous GREEN indicates the system has power applied to it. No light indicates the system does not have power applied to it.
M	Power Button	Toggles the system power on/off.

# Rear Panel

The rear panel contains the system fan, power supply, USB 2.0 ports, gigabit LAN ports, power cord connection, and reset button.

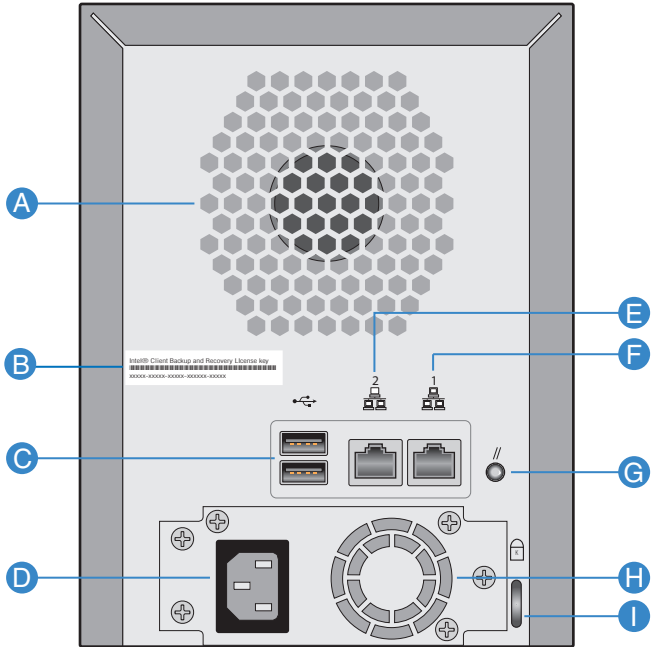

AF000084

Figure 3. Rear Panel Components

**Table 2. Rear Panel LEDs and Components**

Call out	Component	Definition
A	System Fan	
B	License Key	Intel® Client Backup and Recovery License Key
C	USB 2.0 Ports	The USB ports are used to connect an external USB storage device
D	Power Outlet	Supplies power to the device
E	Gigabit LAN Port 2	Gigabit Ethernet connection. The right LED lights up GREEN when connected to a 10/100 MB network, and ORANGE when connected to a gigabit network.
F	Gigabit LAN Port 1	Gigabit Ethernet connection. The right LED lights up GREEN when connected to a 10/100 MB network, and ORANGE when connected to a gigabit network.
G	Reset Button	Press the Reset Button for three seconds to revert the unit to the system defaults.
H	Power Supply Fan	
I	Security Slot	Anti-theft slot for attaching a security cable.

## System Requirements

The following minimum system requirements must be met before setting up the Intel® Entry Storage System SS4000-E. See the *Tested Hardware and Operating Systems List* at <http://support.intel.com/support/motherboards/server/ss4000-e/> for the latest list of compatible operating systems and hard drives.

**Table 3. System Requirements**

Component	Requirement
Web Browser	Microsoft Internet Explorer* 6.0 or above, Firefox* 1.06 or above
Network Environment	TCP/IP networking environment.
SATA Hard Disk	At least one SATA hard disk must be installed with an 80-GB capacity minimum. Additional hard disks can be added.
Operating Systems for Folder Access	Microsoft Windows Server 2003*, Microsoft Windows 2000* Professional, Microsoft Windows XP* Home or Professional, Apple* OS X, Red Hat* Linux
Operating Systems for Intel® Client Backup and Recovery	Microsoft Windows XP* Home Edition or Professional with Service Pack 1 or Service Pack 2, Microsoft Windows Server 2003* with Service Pack 1
Active Directory operating systems used as Domain Controller	Microsoft Windows 2003* Enterprise Edition or Small Business Edition, each with Service Pack 1

## Accessories and Spare Parts

The Intel® Entry Storage System SS4000-E supports up to two USB devices, such as USB drives, which can be purchased separately.

The following accessories and spare parts are available for the Intel® Entry Storage System SS4000-E.

**Table 4. Accessories and Spare Parts Descriptions**

<b>Part Number</b>	<b>Description</b>
FXXSS4000EPS	Power Supply
FXXSS4000ECFAN	Fan
FXX10DVCARBLK	Hard Drive Carriers (10-pack)

*Storage System Features*



## 2 Getting Started

---

Getting started with your Intel® Entry Storage System SS4000-E involves the following general steps:

1. Set up your storage system: Installing the hard disks, attach any optional USB devices, attach the storage system to your network, and power up the system.

For information about this step, see [“Setting up the Storage System” on page 10](#).

***Note:** If your storage system does not have the maximum number of hard disks already installed, it is best to add all the disks that you want to use before you initialize and configure your system. You can add more disks later, but changing your disk configuration might cause data loss. For more information, see [“Levels of RAID” on page 169](#).*

2. Install the Storage System Console on a computer in the same subnet as your storage system and initialize the hard disks on your storage system. Install the operating system and other software from your storage system’s flash memory to each of the hard disks in your storage system. Your vendor might have already performed this step for you.

For information about this step, see [“Initializing your Storage System” on page 16](#).

3. Configure your storage system: Before you can use your storage system, you must perform initial configuration tasks, like setting the date and time, and specifying how much space to use for file sharing and how much to use for backups. The System Setup Wizard guides you through this process.

For information about this step, see [“Configuring Your Storage System” on page 21](#).

4. After the storage system restarts, access the Web-based management interface (the Manager) and log in.

For information about this step, see [“Accessing the Manager” on page 25](#) and [“Logging in to the Manager” on page 27](#).

5. Add users. This is necessary only if you are using local authentication mode and want to control access to the shared folders, or if some users in your network use Linux or Macs other than those running OS X.

For information about this step, see [“Adding Users” on page 32](#).

6. Create shared folders. By default, the Intel® Entry Storage System SS4000-E includes a shared folder named **public**. You might want to create other shared folders. For example, in an office environment, you might want to create a shared folder for company policies that everyone can view, and separate folders for confidential business documents that only selected individuals can view or change. In a home environment, you might want to set up separate folders for different types of files, like photos, videos, or music.

For information about this step, see [“Creating Shared Folders” on page 35](#).

7. Access the shared folders.

For information about this step, see “[Accessing Shared Folders](#)” on page 79.

8. Protect your computer hard disks: Install the Intel® Client Backup and Recovery software on each computer that you want to protect and specify which hard disks or partitions to back up and how often backups should occur. A key code must be purchased for each additional system that you intend to back up. The key code for backing up your system is on the back of the unit.

For information about this step, see “[Protecting Local Disks](#)” on page 89.

## Setting up the Storage System

Your storage system might come pre-installed with hard drives, or you might need to purchase and install them yourself. If you have fewer than four hard drives, you might want to add more now. You can add more disks later, but changing your disk configuration might cause data loss. For more information, see [Appendix A, "Levels of RAID,"](#) beginning on page 169.

The Intel® Entry Storage System SS4000-E supports optional USB devices, such as USB disks. If you have such devices, you can attach them now, or you can attach them later. See the *Tested Hardware and Operating Systems List* at <http://support.intel.com/support/motherboards/server/ss4000-E/> for a list of tested devices.

Whether or not you add hard disks or USB devices, you must connect the storage system to your network, power it up, and upload the firmware.

## Installing the Hard Disks

At least one SATA hard disk with at least an 80-GB capacity must be installed before the storage system can be used. The Intel® Entry Storage System SS4000-E does not ship with any hard disks installed.

**Important:** *The Intel® Entry Storage System SS4000-E supports hot swapping of hard disks. However, data should be backed up before replacing any hard disks.*

**Important:** *An empty drive carrier with baffle MUST be fitted in ALL unused drive bays. There is inadequate drive cooling if any drive bays are left open.*

1. Observe all safety and ESD precautions listed in [Appendix H, “Safety Information”](#).
2. If powered up, power down the system by pressing the power button on the front of the system.
3. Press the green latch at the end of the drive carrier to disengage the drive carrier from the storage system. Pull out on the black lever to slide the drive carrier out of the storage system.



TP000230

**Figure 4. Removing Drive Carrier from Storage System**

4. Remove the four screws that attach the plastic baffle to the drive carrier. Two screws are located on each side of the drive carrier.

*Note:* Store the plastic baffle for future use.

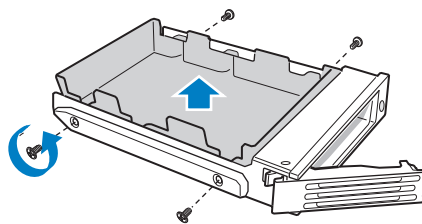

TP00928

**Figure 5. Removing Baffle from Drive Carrier**

5. Remove the hard disk from its wrapper and place it on an anti-static surface. Make sure that the hard disk is a SATA hard disk. It should have a rear SATA connector similar to the following figure.

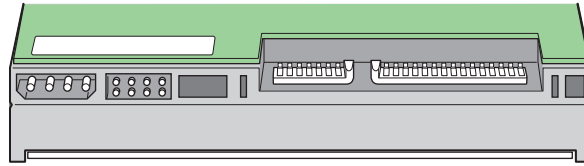

AF000306

**Figure 6. Rear View of SATA Hard Disk**

6. With the hard disk circuit-side down, position the connector end of the hard disk so it faces the rear of the drive carrier. Align the holes in the hard disk to the holes in the drive carrier and attach the hard disk to the carrier with the screws that were removed in Step 4.

**Note:** Do not to remove the side rail on the right side of the drive carrier. This rail contains the light pipe that displays the LED light on the front of the drive carrier. If the side rail comes loose, ensure that the light pipe is properly inserted into the LED hole before reattaching the side rail to the drive carrier.

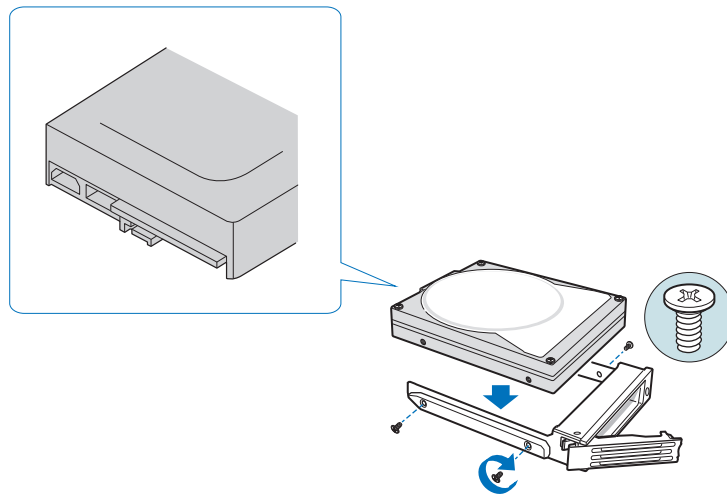

TP00929

**Figure 7. Installing Hard Disk into Drive Carrier**

7. Label the hard disk with the appropriate label. Starting with the uppermost drive, label the hard disks, 1 to 4, in the order shown in the following figure.

**Note:** *The order of drive carriers is critical when replacing hard disks or performing maintenance. A hard disk plugged into an incorrect slot once set up for RAID can result in data loss or an improperly functioning storage system.*

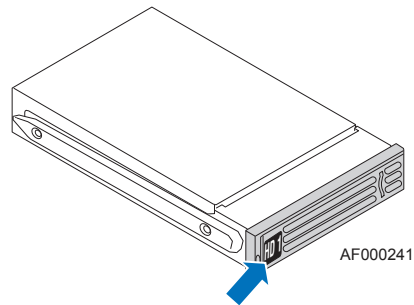

**Figure 8. Applying Label to Hard Disk**

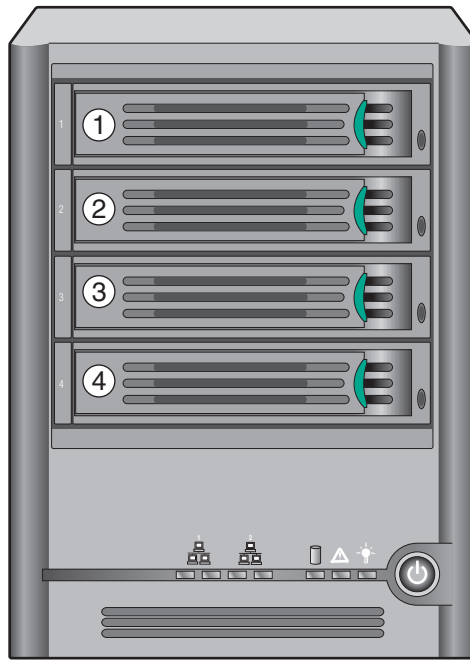

TP02348

**Figure 9. Order of Drive Carriers**

8. With the lever in the fully open position, insert the drive carrier into the storage system. The green latch at the front of the drive carrier must be at the right. Do not push on the black drive carrier lever until the lever begins to close by itself. Once the black drive carrier lever begins to close by itself, push on it to lock the driver carrier into place.

**Important:** Ensure that the drive carrier is orientated so that the hard disk is on top and the drive carrier lever opens from the right. Do not force the drive carrier into the storage system. If there is resistance, make sure that the drive carrier lever is in the fully open position.



TP02349

**Figure 10. Re-installing Drive Carrier into Storage System**

## Attaching the Storage System to the Network

To connect the storage system to your network, insert one end of the RJ-45 Ethernet cable into the Ethernet port 1 on the back of the storage system. See letter “A” in the following figure. Insert the other end of the RJ-45 Ethernet cable into a network port.

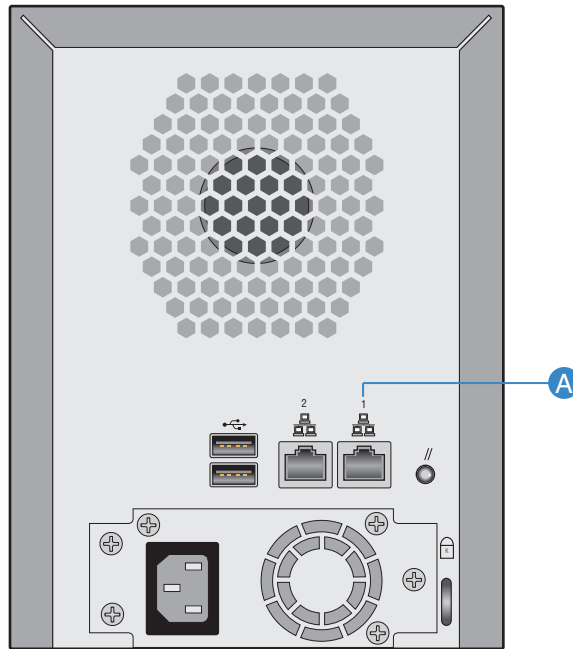

AF000237

**Figure 11. Connecting Storage System to Network**

## Powering Up the Storage System

**Note:** *It is recommended that you plug the storage system into a surge protector or uninterruptible power supply to prevent damage to the system from power surges.*

Plug in the system and then press the power button on the front of the storage system. See letter “A” in the following figure.

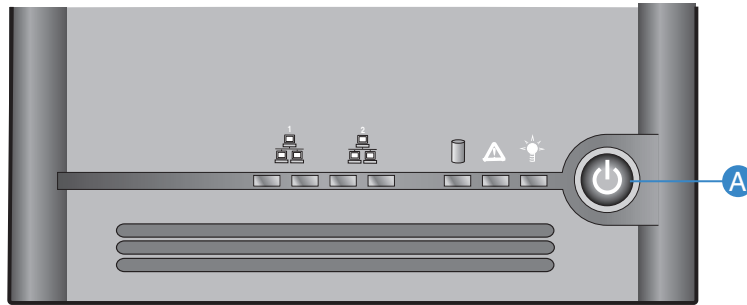

AF000239

**Figure 12. Powering up the Storage System**

The System Status LED light blinks green while the storage system boots. Once the system is booted, the System Status LED and Disk Status LED remains green.

The System Status LED turns solid yellow when you power up the system for the first time, indicating the hard drives are not configured with a RAID level. It remains yellow until the drives are configured then the Status System LED turns solid green.

## Powering Down the Storage System

See “[Shutting Down the Storage System](#)” on page 77 for information on shutting down the storage system.

## Initializing your Storage System

If your vendor installed the hard disks, they might have already been initialized. The operating system that runs the storage system is loaded on the hard drives as part of the initialization process. If your vendor did not initialize the disks, you must do so before you can configure and use your storage system.

To determine whether or not your disks are initialized, and to initialize them if this has not already been done, install the Storage System Console on a computer in the same subnet as your storage system and use that application to connect to the storage system.



## Installing the Console

Install the Console on any computer that runs one of these operating systems:

- Microsoft Windows Server 2003\*
- Microsoft Windows XP\*
- Microsoft Windows 2000\* Professional, Server, or Advanced Server with Service Pack 2 or newer

**Note:** To access the storage system, the Console launches a Web browser, so the computer where you install the Console must have Microsoft Internet Explorer 6.0 or Firefox 1.06 or newer installed and set as the default browser. If you are not sure how to configure the default browser, see the documentation for your browser.

To install the Console:

1. At a computer in the same subnet as your storage system, insert the installation CD.
2. Select Software from the top menu.



3. Select the “Intel® Storage System Console” link to install the software.

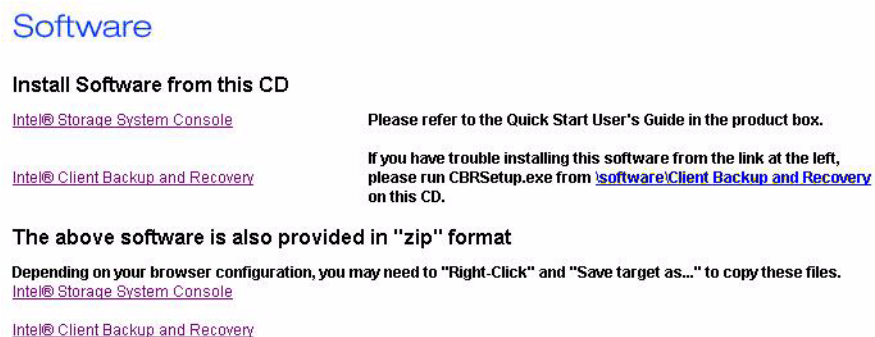

4. Start the setup utility for the Console.
5. On the welcome page, click **Next**.

6. If you agree to the terms of the license agreement, click **Yes**.
7. Enter your name and company name and then click **Next**.
8. Click **Next** to install the Console in the displayed location, or click **Browse** to select or specify a different location and then click **Next**.

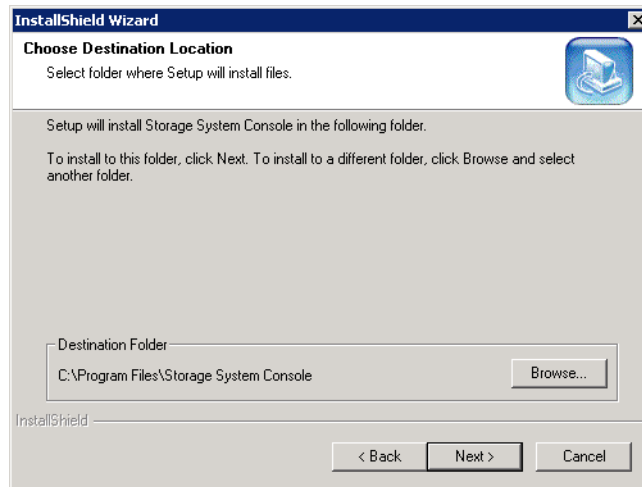

9. Review your selections and click **Next**.
10. If you want to start the Console immediately after it is installed, click the **Launch Storage System Console** check box. Click **Finish**.

## Starting the Console

**Note:** *If the storage system is not directly connected to your computer and your network does not have a DHCP server, you must change the IP address of your computer to use the same subnet as the storage system. You can change it back after you have configured the storage system.*

*To do this, access your local area network properties. For example, you might right-click **My Network Places** and click **Properties**, and then right-click your network connection and click **Properties**. In the list, select **Internet Protocol (TCP/IP)** and click **Properties**. The IP address can be any address beginning with 192.168.0 except 192.168.0.101, since that's the IP address used by the storage system. The subnet mask must be 255.255.255.0. Then click **OK** to close each open dialog box.*

*When you configure the storage system, as described in “[Configuring Your Storage System](#)” on page 21, you can specify the IP address you want the storage system to use. If the IP address of the storage system is in a different subnet than your computer, you must specify the gateway, as described in “[Changing the Network Settings](#)” on page 68. This ensures that you can manage the storage system from any computer using a Web browser, as described in “[Accessing the Manager](#)” on page 25. Then you can change your computer's IP address back to its original setting.*

To start the console:

1. Click **Start > Programs > Storage System Console**.

As soon as you start the Console, it scans the network for storage systems. This might take a few minutes. When the scan is complete, the left pane displays a tree view of all the storage systems it found.

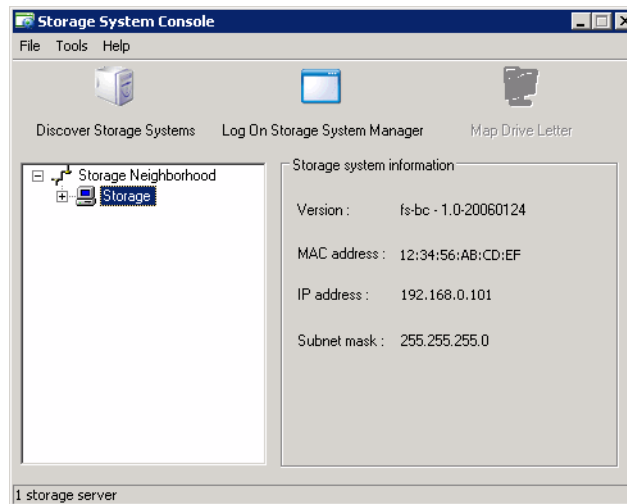

Each storage system has two ports for connecting to the network. If your storage system uses both ports, two items display in the tree in the left pane, each using the same name. You can identify the IP address used by each port by clicking each item in the tree and observing the **IP address** area in the right pane.

**Note:** *If you connect a storage system to the network after the Console has already scanned it, or if you subsequently change the IP address of the storage system, you must click **Discover Storage Systems** to scan the network again and update the tree in the left pane.*

*If no storage system displays in the left pane, your computer might not be in the same subnet as the storage system. Be sure to install the Console on a computer in the same subnet as the storage system and try again.*

2. In the left pane, select the name of the storage system that you want to access, such as **Storage**, and then click **Log On Storage System Manager**. If your storage system uses both available ports to connect to the network, you can select either item.
3. If your storage system has not been initialized, the **System Initialization** page displays. For more information, see the next section, [“Initializing the Disks.”](#)

If your storage system been initialized but not configured, the welcome page for the System Setup Wizard displays. For more information, see [“Configuring Your Storage System” on page 21.](#)

If your storage system has been initialized and configured, the login page for the Manager displays. For more information, see [“Logging in to the Manager” on page 27.](#)

## Initializing the Disks

Once you have installed the Console and connected to the storage system, the **System Initialization** page displays.

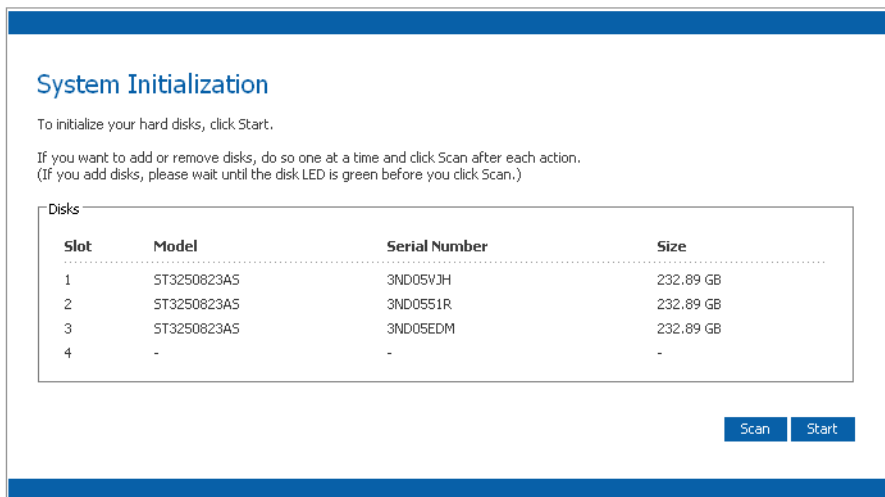

If not all the hard disks have been detected, or if you want to add, remove, or reorder the disks, insert or remove the disks one at a time and click **Scan** after each action.

**Note:** *If you have four disks that are not the same size, it is recommended that you put disks close in size in slots 1 and 2.*

*For example, if one disk is 100 GB, one disk is 200 GB, one disk is 300 GB, and one disk is 400 GB, you should put the 100-GB disk in slot 1 and the 200-GB disk in slot 2 instead of putting the 100-GB disk in slot 1 and the 300- or 400-GB disk in slot 2. This ensures that if you use a RAID 10 configuration, the amount of disk space available for data is maximized.*

*For more information about disk configurations, see “Levels of RAID” on page 169.*

To initialize the hard disks:

1. Click **Start**. The firmware is uploaded to the hard disks. When this process is complete, the storage system restarts.

**Note:** *The operating system and storage system software are installed on each disk in your storage system to ensure that the failure or removal of any one disk does not cause the entire storage system to fail.*

2. If the welcome screen does not display immediately after the storage system restarts, close the browser window and log in again using the Console.

You can now perform the initial configuration as described in “Configuring Your Storage System” on page 21.

## Configuring Your Storage System

Once your storage system has been initialized as described in “[Initializing your Storage System](#)” on page 16, follow these steps to run the System Setup wizard and perform the initial configuration:

1. If you have not already installed the Storage System Console, install it as described in “[Logging in to the Manager](#)” on page 27 and start it as described in “[Starting the Console](#)” on page 18.

In the left pane, click the name of the storage system. If you are using both Ethernet ports, the name of the storage system displays twice in the left pane. You can click either one. Then click **Log On Storage System Manager**.

The welcome page displays:



2. On the welcome page, click **Next**. The **End User Software License Agreement** page displays:
3. If you agree to the terms, select the **I accept the license agreement** check box and then click **Next**. The **Host Name** page displays:

4. Click **Next** to accept the default storage system name (**Storage**), or enter the name you prefer.

The storage system name can be up to 15 characters long and can include letters, numbers, and hyphens.

Click **Next**. The **Date/Time** page displays:

System Setup : Date/Time

Please specify the current date and time

Date : 6 / 30 / 2006 (Month / Day / Year)

Time : 16 : 27 : 3 (Hour : Minute : Second)

Time zone : (GMT-04:00) Atlantic Time (Canada)

Back Next

5. Specify the current date, time, and time zone in 24-hour format. For example, 2:00 P.M. is entered as 14:00:00.

**Note:** The storage system time does not automatically change to reflect daylight savings time. For more information, see [“Changing the System Settings” on page 66](#).

Click **Next**. The **Network Settings** page displays:

System Setup : Network Settings

If you have a DHCP server on your network, this server can get its IP address from that DHCP server automatically. If you don't have a DHCP server, you must use the default IP address or specify a different one.

If your network uses a different subnet mask, you can change the one shown here, but in most cases you can use the default subnet mask.

Get an IP address automatically

Use this IP address:

Port 1

IP address : 192 . 168 . 0 . 101

Subnet mask : 255 . 255 . 255 . 0

Gateway IP address : 0 . 0 . 0 . 0

Back Next

6. By default, if your network has a DHCP server, the storage system obtains its IP address from that server.

If your network does not have a DHCP server or if the storage system is directly attached to your computer, the default IP address and subnet mask are used. The default IP address is 192.168.0.101, and the default subnet mask is 255.255.255.0.

To accept the default settings, click **Next**. Otherwise, specify the desired settings and then click **Next**.

When you click **Next**, the **Disk Configuration** page displays. The options that display on this page vary, depending on the number of hard disks that are currently installed in the system.

**Caution:** *RAID 0 and linear disk configurations do not offer any data protection. If you lose a hard disk, data loss occurs.*

7. If you want to add or remove hard disks, do so one at a time and click **Scan** after each action.

**Note:** *It is strongly recommended that you install all the hard disks that you want to use in the storage system at this time, since changing the number of hard disks later can require disk reconfiguration and possible data loss.*

To accept the default disk configuration, which provides the best level of data protection available for the number of hard disks currently installed, click **Next**. By default, a linear disk configuration is used for a single hard disk, RAID 1 is used for two hard disks, and RAID 5 is used for three or four hard disks.

If you want to change the disk configuration, select the desired RAID level and then click **Next**. For detailed information about the different RAID levels, see [Appendix A, "Levels of RAID,"](#) beginning on page 169.

When you click **Next**, the **Disk Space Distribution** page displays:

**System Setup : Disk Space Distribution**

Your storage system is divided into two partitions, one for shared folders and one for backups. The maximum amount of shared folder space is 2 TB (1 TB=1024 GB). The minimum space requirement is 200 MB. You can allocate more space now or accept the default minimum space allocation. To allocate additional space, select the Specify disk space button and specify 1 GB (1024 MB) or higher. Specify how much space you want to allocate for "public" shared folder and "home" folders.

Once you allocate a certain amount of space for shared folders, you cannot reduce it. If you plan to back up computer disks to your storage system, it is recommended that you use the minimum amount of disk space for shared folders, back up all the computer disks that you plan to protect, and then expand the space allocated for shared folders. This ensures that adequate space is available for backups.

Available disk space : 700.29 GB

**Home**

Use the minimum amount of space for shared folders (200 MB)

Specify disk space :  GB

**Public**

Use the minimum amount of space for shared folders (200 MB)

Specify disk space :  GB

[Back](#) [Finish](#)

8. Capacity in your storage system is divided into partition: one for a shared public folder, one for user home folders, and one for backups. To accept the defaults, click **Finish**. Otherwise, specify the disk space allocations for the home user folders and the public folders in GB. The remaining space is allocated for backup. When you are done, click **Finish**.

**Note:** *You can expand the amount of disk space allocated for shared or home folders later as long as free disk space is available, but you cannot reduce it without reconfiguring your disks and losing all your data.*

*If you plan to back up computer disks to your storage system, it is recommended that you use the minimum amount of space for shared or home folders, back up all the computer disks that you plan to protect, and then expand the space allocated for shared folders. This ensures that adequate space is available for backups.*



9. On the confirmation message, click **OK**.

The **Configuration** page displays and the system is configured according to the settings you specified. Once the configuration is complete, the system restarts.

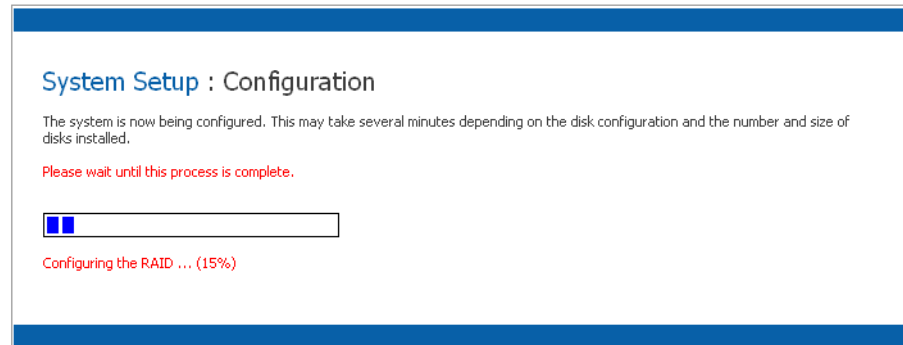

10. After the storage system restarts, you can access the Manager, add users, and create shared folders.

For more information, see [“Accessing the Manager” on page 25](#), [“Logging in to the Manager” on page 27](#), [“Adding Users” on page 32](#), and [“Creating Shared Folders” on page 35](#).

## Accessing the Manager

After you have completed the initialized and configured your storage system as described in [“Initializing your Storage System” on page 16](#) and [“Configuring Your Storage System” on page 21](#), you can access the Manager to add users, create shared folders, and perform other tasks related to managing your storage system.

There are two ways to access the Manager:

- Using the Console
- Using a Web browser (Microsoft\* Internet Explorer 6.0 or Firefox\* 1.06 or newer)

Using the Console, you can access the Manager only from a computer in the same subnet as the storage system, but you do not have to know the name or IP address of the storage system or otherwise modify the network settings.

Using a Web browser, you can access the Manager from any computer in your network, but you must know the name or IP address of the storage system. In addition, if you configured the storage system to use a specific IP address, you might need to specify the IP address of the gateway in your network before you can successfully access the Manager using a Web browser. First access the Manager using the Console and then specify the gateway address as described in [“Changing the Network Settings” on page 68](#) and try to access it with a Web browser.

## Accessing the Manager Using the Console

To access the Manager using the Console:

1. If you have not already done so, install the Console on each computer from which you plan to manage the storage system as described in “[Installing the Console](#)” on page 17.
2. Start the Console and connect to the storage system as described in “[Starting the Console](#)” on page 18.
3. Log in to the Manager as described in “[Logging in to the Manager](#)” on page 27.

## Accessing the Manager Using a Web Browser

To access the Manager using a Web browser:

1. From any computer in your network, run Microsoft Internet Explorer 6.0 or Firefox 1.06 or newer, enter the following in the address bar, and then press Enter:

```
https://storage_system
```

where *storage\_system* is the fully qualified domain name or IP address of the storage system.

**Note:** *You can use the storage system name only if your computer is in the same subnet as the storage system, if you added the storage system’s IP address and name to your local **hosts** file, or if you manually registered the name with a DNS server in your network.*

When the login page displays, you can bookmark it so that you can quickly and easily access it the next time.

2. Log in to the Manager as described in “[Logging in to the Manager](#)” on page 27.

## Logging in to the Manager

To ensure that your connection to the storage system is secure, the HTTPS protocol is used, and only individuals who know the administrator user name and password can view or change any of the storage system settings.

To log in to the Manager:

1. When the security alert appears, click **Yes**. The login page displays.



2. Enter the administrator user name and password.

The default user name is **admin**, and the default password is **storage**. These are case-sensitive. Once you have logged in, you can change both the administrator user name and password at any time. For more information, see [“Changing the System Settings” on page 66](#).

3. Click **Log In**.

## Navigating the Manager

Once you log in to the Manager, the **Home** page displays:

The screenshot shows the Intel Entry Storage System SS4000-E Manager interface. At the top, there is a navigation bar with the following links: Home, Users, Shared Folders, Backups, Advanced, Contact Us, and Logout. The main content area is titled "Welcome to your Intel Entry Storage System SS4000-E". Below the welcome message, there are two buttons: "Storage Status" and "Connection Status". A progress bar indicates that the storage is at 100% capacity. Below the progress bar, there are three summary boxes: "Shared folders", "Backups", and "Storage".

Category	Item	Value
Shared folders	Total shared capacity	195 MB
	Used space	0 MB
	Free space	195 MB
	Shared folders	3
Backups	Used space	0 MB
	Backup clients	0
Storage	Total storage capacity	599.98 GB
	Free space	599.79 GB

The top of the every page in the Manager displays a navigation bar that lets you access all the features of the storage system:

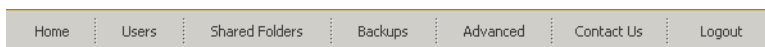

- **Home**—Displays information about your storage system, including how the storage space is being used and which users are connected. For more information, see [“Viewing Information About Your Storage System” on page 30](#).
- **Users**—Displays a list of all currently configured users. If you are using local authentication mode, you can add, modify, and remove all types of users, and add, modify, and remove groups of Windows and Mac OS X users. If you are using Active Directory authentication mode, you can add, modify, and remove Linux users and other Mac users. You can also use this page to change the authentication mode. For more information, see [“Adding Users” on page 32](#).

- **Shared Folders**—Displays a list of all currently configured shared folders and lets you add shared folders, change which users can access them, and remove them.

For more information, see [“Creating Shared Folders” on page 35](#) and [“Managing Shared Folders” on page 54](#).

- **Backups**—Displays a list of all computer disk backups that currently exist and lets you change the recovery password, delete backups or a backup client, and change information related to booting remotely.

For more information, see [“Managing Backups” on page 58](#) and [Chapter 5, “Protecting Local Disks,”](#) beginning on page 89.

- **Advanced**—Provides access to advanced storage system configuration options, such as setting up e-mail alerts; upgrading the firmware; removing USB devices; changing the system, network, or disk configuration settings; viewing information about the system status or system events; and shutting down the system remotely.

For more information, see [Chapter 3, “Managing Your Storage System,”](#) beginning on page 39.

- **Contact Us**—Provides information about Intel and the other products and services it offers.
- **Log Out**—Logs you out of the Manager.

## Viewing Information About Your Storage System

The **Home** page can display two different views: **Storage Status** and **Connection Status**. Switch from one view to the other by selecting the desired option from the **View** list.

- **Storage Status** - Displays information about the total storage capacity on the storage system, how much disk space is allocated for shared folders, how much is currently used by backups, and how much is available for either. Initially, there is no used backup space. The information on this page changes as each computer backs up its hard disks to the storage system. You might have to refresh the browser window to reflect these changes.

This page also indicates how much of the storage space allocated for shared folders is actually used, the total number of shared folders, and the number of networked computers (backup clients) that have backed up one or more disks on the storage system.

Intel® Entry Storage System SS4000-E

Home Users Shared Folders Backups Advanced Contact Us Logout

Welcome to your Intel® Entry Storage System SS4000-E

This interface allows you to create users, groups and shared folders, and also provides access to administrative functions.

To get started, click the Users button above to add a new user. Click the Shared Folders button to add folders and assign users to the folders. Each user can then map a network drive to the shared folder and add files to it. It's that simple!

Storage Status Connection Status

Total Storage Capacity: 599.98 GB

100 %

Shared folders Backups Free space

Shared folders

- Total shared capacity : 195 MB
- Used space : 0 MB
- Free space : 195 MB
- Shared folders : 3

Backups

- Used space : 0 MB
- Backup clients : 0

Storage

- Total storage capacity : 599.98 GB
- Free space : 599.79 GB

**Note:** The amount of used backup capacity is greater than the total size of all the disks listed on the **Backups** page because additional storage space is needed for the data that has changed between backups.

- **Connection Status** - Displays a list of the Microsoft Windows\* and Mac OS X\* users who are currently connected to shared folders, including which shared folder they are accessing and when they logged on.



The screenshot shows the web interface for the Intel Entry Storage System SS4000-E. The header includes the product name and the Intel logo. A navigation menu contains links for Home, Users, Shared Folders, Backups, Advanced, Contact Us, and Logout. The main content area features a welcome message and instructions. Two buttons, 'Storage Status' and 'Connection Status', are visible. Below the buttons is a table titled 'Connections' with columns for Shared Folders, Users, and Login Time.

Shared Folders	Users	Login Time
public	guest (ibm-ccfc0dc11fd)	Jun 30 2006 17:04:04

**Notes:**

- If anyone accessed a shared folder using the **guest** user name, which is described in more detail in *“Adding Users”* on page 32, **guest** displays in the **Users** column, followed in parentheses by the computer name.
- Due to the nature of the NFS protocol, Linux and other Mac users are not listed on this page.
- Ongoing backup or recovery activities do not display on this page.
- This page indicates only that a connection with a shared folder has been established; this does not necessarily mean that the user has opened any files there.

## Adding Users

**Note:** By default, the Intel® Entry Storage System SS4000-E uses local authentication mode. If your site uses Active Directory, you might want to use Active Directory authentication mode instead. Since all user data and all shared folder assignments are deleted when you switch from one mode to another, you should decide which mode you want to use before proceeding. For more information, see “Changing Authentication Mode” on page 48.

In local authentication mode, by default the Intel® Entry Storage System SS4000-E includes a user named **guest** that has a password of **guest**. Windows and Mac OS X users can access all shared folders that **guest** is authorized to access. However, you might want to add other users as well. For example, if you want to restrict access to a shared folder that contains confidential information, you would add at least one user and authorize that user to access that shared folder and not authorize the **guest** user to access it. Adding a user for each individual or computer in your network provides flexibility and security, enabling you to control who can access what information.

In addition, only Windows and Mac OS X users can use the **guest** user name. Linux users and Mac users who do not use OS X must have user names created to allow them to access shared folders. In Active Directory authentication mode, you can add only Linux/other Mac users.

You can add up to 128 Windows or Mac OS X users, and up to 128 Linux or other Mac users, for a total of up to 256 users.

**Note:** Since each Linux/other Mac user can represent multiple users, the number of actual users can be higher.

To add a user:

1. In the navigation bar, click **Users**. The **Users & Computers** page displays.

### Users : Users & Computers

If you're using local authentication mode, add users here. Optionally, Windows users can be placed into groups so that you can easily assign several users to a shared folder at once. To create a group, first add the users here, then click Groups on the left side of the screen. When you are done adding users and groups, click Shared Folders to assign them to shared folders.

If you're using Active Directory authentication mode, you can't add Windows users here; they are added automatically from your Active Directory server. However, you can add Linux users or Mac users who aren't using Mac OS X.

Current authentication mode : Local authentication mode

Select	Name	Type
<input type="radio"/>	guest	Windows/Mac OS X user (CIFS)
<input checked="" type="radio"/>	mike	Windows/Mac OS X user (CIFS)



2. Click **Add**.

## Users : Users & Computers

What type of user do you want to add?

- Windows/Mac OS X user (CIFS)  
 Linux/Other Mac user (NFS)

Next

Cancel

3. Select the type of user you want to add, and then click **Next**. The operating system used by the user determines which option you should choose—**Windows/Mac OS X user (CIFS)** or **Linux/Other Mac user (NFS)**.

### Notes:

- Linux users and Mac users who are not using OS X access shared folders using the Network File System (NFS). In this environment, access to shared folders is given to entire computers, not to individual users of those computers. However, in Windows and Mac OS X environments, each computer user can have individual access to a shared folder.
- If your storage system uses Active Directory authentication mode, you can add only Linux/other Mac users.

The page that displays next varies, depending on the user type you selected.

### Windows/Mac OS X User (CIFS)

**Users : Users & Computers**

Use this screen to add a Microsoft Windows or Mac OS X user.

Enter the name and password for this user. (The password cannot exceed 24 characters.)

The user must enter this name and password to access any shared folders.

User name :

Password :

Confirm password :

Back Done Cancel

## Linux/Other Mac User (NFS)

### Users : Users & Computers

Use this screen to add a Linux or Mac OS user.

The Computer Description can be the name of the user who typically accesses the computer or any other description to identify the computer.

The IP address or the computer name identifies the Host system. Enter the IP address or computer name for the user that you are adding.

Computer description :

IP address or computer name :

[Back](#) [Done](#) [Cancel](#)

4. Enter the requested user information and click **Done**:

For this type of user	Do this
Windows/Mac OS X user (CIFS)	<p>Enter the user name and password for accessing the shared folders. Enter the password a second time to confirm it.</p> <p>The user name can be up to 20 characters long and can include letters and numbers. The password can be up to 24 characters long.</p> <p>If the user name and password that you specify here are the same as the person's Windows user name and password, the person is not prompted to provide a user name and password when accessing the shared folder.</p>
Linux/Other Mac user (NFS)	<p>Enter a computer description and the IP address or computer name of the person's computer.</p> <p>The <b>Computer description</b> can be the name of the person who typically uses the computer, or any other description that you want to provide to identify the computer in the <b>Users</b> list. This description can be up to 15 characters long.</p> <p>The <b>IP address or computer name</b> is the IP address or the actual computer name in the computer's system configuration.</p> <p>You can create a single user that actually represents multiple users. In the <b>IP address or computer name</b> text box, you can use the wildcard characters * and ? to indicate a range of names. For example, <code>client*</code> or <code>client?</code> would include all computers in the subnet whose name begins with <code>client.*.company.com</code> would include all computers in the domain <code>company.com</code>. However, these wildcards cannot be used with IP addresses.</p>

The specified user name and type displays in the list on the **Users & Computers** page.

5. Repeat steps 2 through 4 until you have added all the users that you want to add at this time. You can add more users later.

If you'd like to put Windows and Mac OS X users into groups, see [“Working with Groups” on page 43](#).

## Creating Shared Folders

By default, the Intel® Entry Storage System SS4000-E includes a shared folder named **public**. In local authentication mode, all Windows and Mac OS X users are automatically assigned to this folder and can create, modify, or delete files there unless you change the list of authorized users or their access rights as described in “[Assigning Users to Shared Folders](#)” on page 56. In Active Directory authentication mode, you must manually assign users to this folder in order to provide them with access.

You might want to create other shared folders as well. For example, in an office environment, you might want to create a shared folder for company policies that everyone can only view, and separate shared folders for confidential business files that only selected individuals or departments can view or change. In a home environment, you might want to create separate folders for different types of files, like photos, videos, or music.

You can create up to 128 shared folders. Users who can access and write to these shared folders can create additional sub-folders for organizing the files they store there.

To create a shared folder:

1. In the navigation bar, click **Shared Folders**. The **Shared Folders** page displays:

### Shared Folders

Use this screen to add, expand, or remove shared folders. Click Add to create a shared folder and allocate folder storage space. Click Expand to increase the shared folder size. Click Remove to delete a shared folder and release the associated disk space.

Select	Shared Name	Size	Used Percentage
<input type="radio"/>	Finance	14.99 GB	<input type="text" value="0"/> 0 %
<input type="radio"/>	Marketing	9.99 GB	<input type="text" value="0"/> 0 %
<input type="radio"/>	homes (User Home Folder)	195 MB	<input type="text" value="0"/> 0 %
<input type="radio"/>	public	195 MB	<input type="text" value="0"/> 0 %
<input type="radio"/>	usbdisk1	0 MB	<input type="text" value="0"/> 0 %
<input type="radio"/>	usbdisk2	0 MB	<input type="text" value="0"/> 0 %

**Note:** The **Shared folders** list includes **usbdisk1** and **usbdisk2** whether or not any USB disks have been connected to the storage system.

2. Click **Add**.

### Shared Folders

Use this screen to create a shared folder and allocate folder storage space. Your storage system is divided into two partitions, one for shared folders and one for backups. The maximum amount of shared folder space is 2 TB (1 TB=1024 GB). The minimum space requirement is 200 MB. You can allocate more space now or accept the default minimum space allocation. To allocate additional space, select the Specify disk space button and specify 1 GB (1024 MB) or higher.



Allocated space is approximate. A small amount will be used by the file system.

Shared folder name :

- Use the minimum amount of space for shared folders (200 MB)
- Specify disk space :  GB
- Add maximum available disk space : 344.58 GB

- In the **Shared folder name** text box, enter a unique name for the shared folder. This name can be up to 64 characters long and can contain letters, numbers, hyphens, underlines, and spaces.
- Your storage system is divided into several partitions, one for shared folders, one for home folders and one for backups. The maximum amount of a shared folder space is 2 TB (1 TB=1024 GB). The minimum space requirement is 200 MB. You can allocate more space now or accept the default minimum space allocation. To allocate additional space, select the Specify disk space button and specify 1 GB (1024 MB) or higher. To allocate the maximum available, select the Add maximum available disk space" raid button. After setting the appropriate value, hit OK. The folder is created and the Shared Folders screen will be displayed

## Managing Shared Folders

When you click **Shared Folders** in the navigation bar, the page displays a list of shared resources, including both shared folders and USB devices. When you select an item in the **Shared folders** list, the users and groups that can access that item display in the **Users with access** list. For groups, the group name is preceded by @.

### Shared Folders

Use this screen to add, expand, or remove shared folders. Click Add to create a shared folder and allocate folder storage space. Click Expand to increase the shared folder size. Click Remove to delete a shared folder and release the associated disk space.

Select	Shared Name	Size	Used Percentage
<input type="radio"/>	Finance	14.99 GB	<input type="text" value="0"/> 0 %
<input type="radio"/>	Marketing	9.99 GB	<input type="text" value="0"/> 0 %
<input type="radio"/>	homes (User Home Folder)	195 MB	<input type="text" value="0"/> 0 %
<input type="radio"/>	public	195 MB	<input type="text" value="0"/> 0 %
<input type="radio"/>	usbdisk1	0 MB	<input type="text" value="0"/> 0 %
<input type="radio"/>	usbdisk2	0 MB	<input type="text" value="0"/> 0 %

By default, the storage system includes a shared folder named **public**. In local authentication mode, all users are automatically assigned to this folder and can create, modify, or delete files there. You can change the list of authorized users or their access rights. In Active Directory authentication mode, you must manually assign users to this folder in order to provide them with access.

The **Shared folders** list includes a NAS share called **homes** (user home folders), and **usbdisk1** and **usbdisk2**, whether or not any USB disks have been connected to the storage system.

You can create additional shared folders and delete them at any time. For both shared folders and USB disks, you can change which users can access them and what they can do with the subfolders and files there.

## Deleting a Shared Folder

Once you have created a shared folder, you can delete it at any time. When you delete a shared folder, any users who are currently accessing it are immediately disconnected from it.

**Caution:** Deleting a shared folder deletes *all* the subfolders and files in that shared folder. If you want to delete only selected subfolders or files, access the shared folder, as described in [“Accessing Shared Folders” on page 79](#), and delete the desired items.

**Note:** *You cannot delete the **public** or the **homes** folder.*

*You cannot delete the contents of a USB disk using the **Shared Folders** page. To delete its contents, you must give yourself read/write access to that disk as described in [“Assigning Users to Shared Folders” on page 56](#), access the disk as described in [“Accessing Shared Folders” on page 79](#), and then delete the desired folders and files.*

*To remove the USB disk from the storage system, use the Manager to disconnect it as described in [“Disconnecting USB Devices” on page 65](#). Then physically unplug the USB disk from the storage system.*

*Even after you physically unplug the USB disk, it remains in the **Shared folders** list. This ensures that you don't have to re-assign users if you later reconnect the USB disk.*

To delete a shared folder:

1. In the navigation bar, click **Shared Folders**.
2. In the **Shared folders** list, select the shared folder that you want to delete.
3. Click **Remove**.

## Assigning Users to Shared Folders

1. In the navigation bar, click **Shared Folders**.
2. In the **Shared folders** screen, select the shared assignments from the left menu
3. Click Assign Access

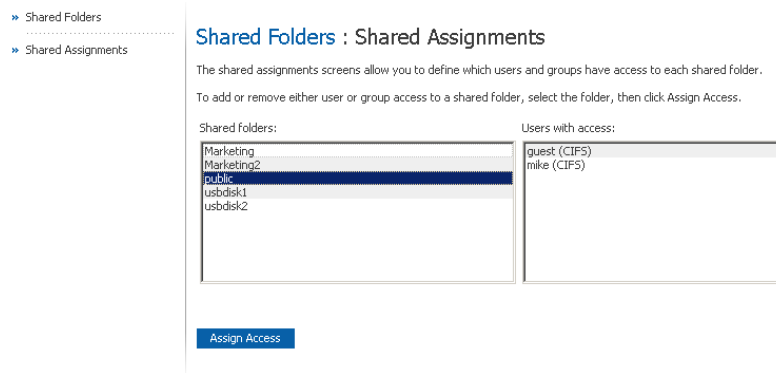

4. Select either the **CIFS**, **NFS** or **GROUP** tabs, and then the user that you want to assign and change the access level.

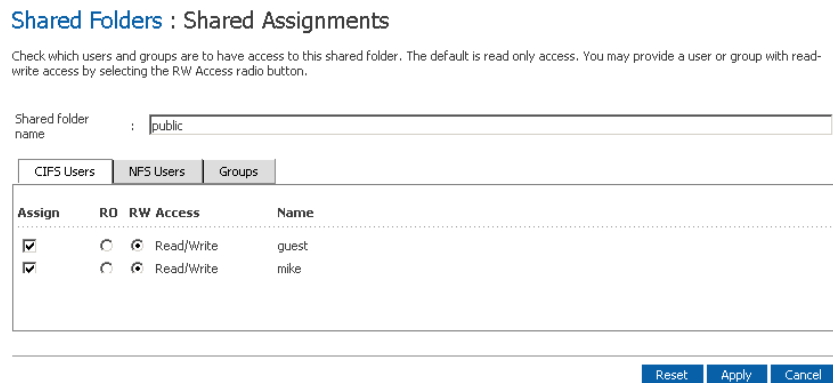

Although you can choose only one user type at a time, you can assign both types of users to the same shared folder.

5. When finished, click **Apply** then **OK**.
6. To assign users of a different type, repeat this procedure, selecting the other user type in Step 4.

# 3 Managing Your Storage System

---

The Web-based storage system Manager enables you perform a number of tasks to help you get the most from your storage system:

- [Managing Users](#)—Add, modify, or remove users; put users into groups; or change the authentication mode.
- [Managing Shared Folders](#)—Create shared folders, rename existing shared folders, change which users can access existing shared folders or their access rights, and delete shared folders that you no longer want to keep.
- [Changing Authentication Mode](#)—Change the storage the authentication mode to either local or authenticate using active directory.
- [Managing Backups](#)—View which computer disks are backed up, change the password for recovering a backup, specify which backup to remotely boot from, or delete a backup or backup client.
- [Setting Up e-mail Alerts](#)—Specify whether or not e-mail notifications should be sent when a problem occurs, and who should receive the notifications.
- [Upgrading the Firmware](#)—Upgrade your storage system firmware to the latest version.
- [Disconnecting USB Devices](#)—If you are using optional USB devices, you must use the Manager to disconnect them before you physically unplug them.
- [Changing the System Settings](#)—Change the storage system name or time and date settings, as well as the user name or password for logging in to the Manager.
- [Changing the Network Settings](#)—Change the workgroup name, the storage system's IP address(es), or the gateway or DNS server settings, or enable the storage system to act as an FTP server.
- [Reconfiguring Your Storage System Disks](#)—Change the proportions of your storage system that are allocated to shared folders and backups, or change your disk configuration.
- [Viewing System Status Information](#)—See details about CPU and memory usage, how long the storage system has been running, disk temperatures, etc.
- [Logging Out of the Manager](#)—Log out of the Manager so that no one else can use your computer to make changes to the storage system.
- [Shutting Down the Storage System](#)—Shut down the storage system using the Manager rather than pushing the power button on the storage system manually.

## Managing Users

When you click **Users** in the navigation bar, the **Users & Computers** page displays a list of all configured Windows and Mac OS X users, and all Linux and other Mac computers. In this guide, the term *user* refers to both individuals and computers.

### Users : Users & Computers

If you're using local authentication mode, add users here. Optionally, Windows users can be placed into groups so that you can easily assign several users to a shared folder at once. To create a group, first add the users here, then click Groups on the left side of the screen. When you are done adding users and groups, click Shared Folders to assign them to shared folders.

If you're using Active Directory authentication mode, you can't add Windows users here; they are added automatically from your Active Directory server. However, you can add Linux users or Mac users who aren't using Mac OS X.

Current authentication mode : Local authentication mode

Select	Name	Type
<input type="radio"/>	Greg	Linux/Other Mac user (NFS)
<input type="radio"/>	guest	Windows/Mac OS X user (CIFS)
<input type="radio"/>	mark	Windows/Mac OS X user (CIFS)
<input type="radio"/>	mike	Windows/Mac OS X user (CIFS)

[Add](#) [Edit](#) [Remove](#)

By default, the storage server uses local authentication mode, which means that you can add, modify, or remove all types of users at any time. If you are using Active Directory authentication mode, you can add, modify, or remove Linux or other Mac users, but not Windows users. All Windows users are controlled entirely by the Active Directory server. For more information about authentication modes, see [“Changing Authentication Mode” on page 48](#).

If you are using local authentication mode, you can also put Windows and Mac OS X users into groups. This makes it easier to give several users access to the same shared folder at once. For example, in an office environment, you might create one group for all users and give that group read-only access to a shared folder with corporate policies. You might then create separate groups for each department, such as Sales or HR, and give those groups read/write access to shared folders with information specifically for those groups. Each user can be a member of multiple groups.

If you are using Active Directory authentication mode, you cannot create groups with the Manager. All groups are controlled by the Active Directory server.



## Adding Users

To add a user, see [“Adding Users” on page 32](#).

## Modifying Users

In local authentication mode, for Windows and Mac OS X users you can change the password used to access the shared folders, but not the user name. This change will not affect current connections, but will take effect the next time the person tries to connect to a shared folder. In Active Directory authentication mode, you cannot modify Windows/Mac OS X users, only Linux/other Mac users.

For Linux and Mac users, you can change the IP address or computer name, but not the computer description. Changing this information immediately disconnects that computer from the shared folders.

**Note:** To change the user name or computer description, you must remove the existing user as described in [“Removing Users” on page 43](#), and then add a new user with the desired name or description as described in [“Adding Users” on page 32](#).

To modify a user:

1. In the navigation bar, click **Users**.
2. Select the radio button next to the user that you want to modify.
3. Click **Edit**.

**Note:** If the storage system uses Active Directory authentication mode and you select a Windows/Mac OS X user, this button displays dimmed.

The page that displays next varies, depending on the type of user you selected.

### Windows/Mac OS X User (CIFS)

#### Users : Users & Computers

The user must provide this user name and password to access any shared folders.



The password cannot exceed 24 characters.

User name	:	<input type="text" value="mark"/>
Password	:	<input type="password"/>
Confirm password	:	<input type="password"/>

OK

Cancel

### Linux/Other Mac User (NFS)

## Users : Users & Computers

Use this screen to edit a Linux or Mac OS user.

The IP address or the computer name identifies the Host system. Edit the IP address or computer name for the user that you wanted.

Computer description :

IP address or computer name :

4. Make the desired change and click **OK**:

For this type of user	Do this
Windows/Mac OS X user (CIFS)	<p>Enter the password for accessing the shared folders. Enter the password a second time to confirm it.</p> <p><b>NOTE:</b> If the user name and password specified here are the same as the person's Windows user name and password, the person is not prompted to provide a user name and password when accessing the shared folders.</p>
Linux/Other Mac user (NFS)	<p>Enter the computer's IP address or the actual computer name in the computer's system configuration.</p> <p>A single user can actually represent multiple computers. In the <b>IP address or computer name</b> text box, you can use the wildcard characters * and ? to indicate a range of names. For example, <code>client*</code> or <code>client?</code> would include all computers in the subnet whose name begins with <code>client.</code> <code>*.company.com</code> would include all computers in the domain <code>company.com</code>. However, these wildcards cannot be used with IP addresses.</p> <p><b>NOTE:</b> If the user is currently connected to a shared folder, changing this information disconnects the user.</p>

## Removing Users

In local authentication mode, you can remove any user except the **guest** user. In Active Directory authentication mode, you can remove any Linux user or Mac user not running Mac OS X, but you cannot remove any Windows/Mac OS X user. Those can be removed only on the Active Directory server.

If you remove a user who is currently connected to the storage system, that user remains connected until the user disconnects from the shared folder or shuts down the computer.

To remove a user:

1. In the navigation bar, click **Users**.
2. Select the radio button next to the user that you want to remove.
3. Click **Remove**.

***Note:** If the storage system uses Active Directory authentication mode and you select a Windows/Mac OS X user, this button appears dimmed.*

4. When prompted to confirm the removal, click **OK**. The user no longer displays in the list on the **Users** page.

## Working with Groups

Windows and Mac OS X users can be put into groups, which makes it easier to give several users access to the same shared folder at once.

To view user groups:

1. In the navigation bar, click **Users**.
2. In the left pane, click **Groups**. The page displays a list of all currently configured groups.
3. Select a group from the Groups list to view the members of that group. The members of that group in the adjacent **Members** list.

## Users : Groups

If you're using local authentication mode, grouping users provides a way to assign many users to shared folders at the same time. Only Microsoft Windows users can be included in groups.

If you're using Active Directory authentication mode, you can't add groups here; they are added automatically from your Active Directory server.

Current authentication mode : Local authentication mode

Groups:	Members:
group1	guest mike

If you are using local authentication mode, you can add a group, modify the group membership, or remove groups at any time. If you are using Active Directory authentication mode, you can view the group membership but you cannot add, modify, or remove groups. Those actions can be done only on the Active Directory server.

## Adding a Group

In local authentication mode, when you create a group, you typically assign users to groups as you add them, although you can create an empty group and add users later. You can create up to 128 groups. Users must be created before they can be added to a group. see [“Adding Users” on page 32](#). A user can be a member of multiple groups.

To add a group:

1. In the navigation bar, click **Users**.
2. In the left pane, click **Groups**.

3. Click **Add**.

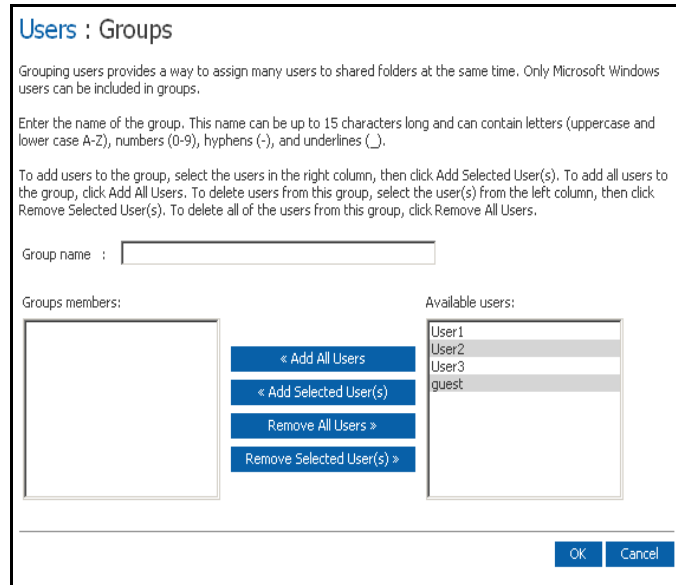

*Note:* If the storage system uses Active Directory authentication mode, this button displays dimmed.

4. In the **Group name** text box, enter a unique name for the group. This name can be up to 15 characters long and can include letters, numbers, hyphens, and underlines.
5. Specify which users should belong to this group, and then click **OK**:

To do this	Do this
Add all users to the group	Click <b>Add All Users</b> . All users move from the <b>Available users</b> list to the <b>Group members</b> list.
Add selected users to the group	In the <b>Available users</b> list, select the user(s) that you want to add and then click <b>Add Selected User(s)</b> . <sup>a</sup>
Remove all users from the group	Click <b>Remove All Users</b> . All users move from the <b>Group members</b> list to the <b>Available users</b> list.
Remove selected users from the group	In the <b>Group members</b> list, select the user(s) that you want to remove from the group and then click <b>Remove Selected User(s)</b> . <sup>a</sup>

**NOTES:**

- a. To select multiple, contiguous users, hold down the Shift key and select the first user, then select the last user. All users between the first and last selected user are selected.  
To select multiple, non-contiguous users, hold down the Ctrl key as you select each user.

## Changing the Group Membership

In local authentication mode, you can change which users are members of each group at any time. When you add a user to a group, that user has immediate access to all the shared folders that the group is authorized to access. However, if you remove a user from a group, the change does not take effect until that user disconnects from the shared folder or shuts down the computer.

For example, the user Alice might be a member of both the Marketing and Executives groups. The Marketing group might have read-only access to the Budget shared folder, and the Executives group might have read/write access. As a member of the Executives group, Alice would have read/write access to that shared folder. If Alice is currently connected to that shared folder and you subsequently remove her from the Executives group, she continues to have read/write access to that folder until she disconnects or shuts down her computer. The next time she connects, she continues to have access to the shared folder since she is still a member of the Marketing group, but she is able to only view the files there; she cannot add, modify, or delete files.

To change the group membership:

1. In the navigation bar, click **Users**.
2. In the left pane, click **Groups**.
3. In the **Groups** list, select the group whose membership you want to change.
4. Click **Edit**.

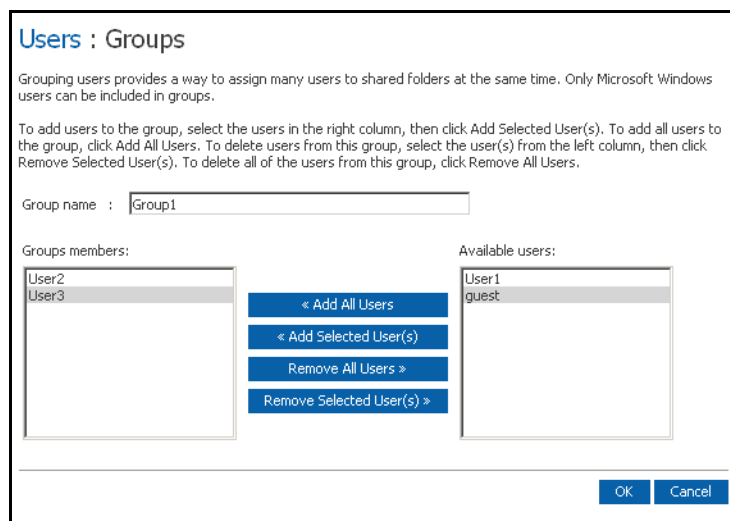

**Note:** If the storage system uses Active Directory authentication mode, this button appears dimmed.

5. Assign users to this group as needed, and then click **OK**:

To do this	Do this
Add all users to the group	Click <b>Add All Users</b> .
Add selected users to the group	In the <b>Available users</b> list, select the user(s) that you want to add and then click <b>Add Selected User(s)</b> . <sup>a</sup>
Remove all users from the group	Click <b>Remove All Users</b> .
Remove selected users from the group	In the <b>Group members</b> list, select the user(s) that you want to remove from the group and then click <b>Remove Selected User(s)</b> . <sup>a</sup>

**NOTES:**

- a. To select multiple, contiguous users, hold down the Shift key and select the first user, then select the last user. All users between the first and last selected user are selected.  
 To select multiple, non-contiguous users, hold down the Ctrl key as you select each user.

The selected users move from one list to the other.

On the **Groups** page, when you select this group in the **Groups** list, the adjacent **Members** list immediately reflects the changes you just made.

## Removing a Group

In local authentication mode, removing a group does not remove the users that are members of that group; it simply means that the group no longer displays in the Groups list on the Groups page. The users remain listed on the Users & Computers page. In Active Directory authentication mode, you cannot remove a group on the storage system. That can be done only on the Active Directory server.

However, removing a group can affect access to shared folders. When you remove a group, the members of that group no longer has access to any shared folders that the group was authorized to access unless they were granted individual access as well.

For example, the Executives group might include Alice, Bob, and Carlos, and that group might have read/write access to the Budget shared folder. If you remove the Executives group, Alice, Bob, and Carlos remain users, but they no longer have access to that shared folder.

On the other hand, if the Executives group had read/write access to the Budget shared folder, but Alice had read-only access, when you remove the group, Bob and Carlos no longer have access to the Budget shared folder since their access rights were determined by their group membership, but Alice continues to have read-only access, since that access right was granted to her on a user level.

To remove a group:

1. In the navigation bar, click **Users**.
2. In the left pane, click **Groups**.
3. In the **Groups** list, select the group that you want to remove.
4. Click **Remove**.

*Note:* If the storage system uses Active Directory authentication mode, this button displays dimmed.

5. When prompted to confirm the removal, click **OK**. The group no longer displays in the **Groups** list.

## Changing Authentication Mode

Your Intel® Entry Storage System SS4000-E can operate in one of two modes:

- Local authentication mode
- Active Directory authentication mode

In local authentication mode, the storage system authenticates all users who try to connect to shared folders, and you can add, modify, or remove all types of users (both Windows/Mac OS X and Linux/other Mac users). By default, the storage system uses local authentication mode.

In Active Directory authentication mode, the Active Directory server authenticates all Windows users who try to connect to shared folders. You can add, modify, or remove Linux /other Mac users, but not Windows users. In addition, you cannot create groups. All Windows users and groups are controlled entirely by the Active Directory server.

### *Notes:*

- The authentication mode has no effect on backups performed using Client Backup and Recovery.
- If you use Active Directory authentication mode, the **User must change password at next logon** check box must be cleared in the properties for each user on the Active Directory server who will be accessing shared folders on the storage system. In addition, each user's password can be no longer than 24 characters.
- If you use Active Directory authentication mode, you must add any Mac OS X users to your Active Directory server in order to provide those users with access to shared folders on the storage system.
- Active Directory authentication mode does not automatically include a guest account. However, the Active Directory administrator can create one on the Active Directory server.
- "ftp" and "anonymous" are reserved for internal use. It is recommended that you do not create user accounts with these names in the Active Directory server.
- It is recommended that you select the root of all the Organization Units (OU) when joining an Active Directory domain in order to have a listing of every user in every OU. If you need to change the OU, you can switch to local mode and then rejoin the domain. However, once you rejoin the domain, user rights to shares will need to be set up again.
- If you use Active Directory authentication mode, and the clocks of the storage system and the Active Directory server differ by more than five minutes, errors will occur when the storage system tries to connect to the Active Directory server. This is when you set the authentication mode, when synchronization between the two systems occurs, and when users access shared folders. It is recommended that you configure



both the storage system and the Active Directory server to set their clocks from a common Network Time Protocol (NTP) server. To configure this on the storage system, see [“Changing the System Settings” on page 66](#).

You can change the authentication mode at any time, but you must provide the administrator password to do so.

**Caution:** *Changing the authentication mode deletes all your existing user data and shared folder assignments. However, if any users are currently accessing shared folders, they will remain connected until they disconnect from the shared folders or shut down their computer.*

To change the authentication mode:

1. In the navigation bar, click **Users**.
2. In the left pane, click **Authentication Mode**. The **Authentication Mode** page displays the current authentication mode.

3. In the **Administrator password** text box, enter the password for accessing the storage system not the active directory password.
4. Click **Change Authentication Mode**.
5. Click **Finish**. All your existing user data and user assignments are deleted, and you can add new users as described in [“Adding Users” on page 32](#), and assign them to shared folders, as described in [“Assigning Users to Shared Folders” on page 56](#).
6. If you are currently using local authentication mode, **Active Directory authentication mode** is selected automatically. Click **Next**. The **Active Directory Server** page displays.

**Users : Active Directory Server**

Enter the IP address of your primary Active Directory server. If desired, you can also enter the IP address of the secondary Active Directory server to use if the primary Active Directory server is not available.

Primary server IP address :

Secondary server IP address :

[Back](#) [Next](#)

7. In the **Primary server IP address** text box, enter the IP address of your primary Active Directory server. You cannot use the server's name.
8. If desired, enter the IP address of a secondary Active Directory server in the **Secondary server IP address** text box. You cannot use the server's name. This server will be used if the primary Active Directory server is not available.  
The secondary server must be in the same domain as the primary server.
9. Click **Next**. The **Active Directory User Login** page displays.

**Users : Active Directory User Login**

Enter the name and password of a user who has privileges to access the Active Directory tree.

If desired, enter the name of the organizational unit that contains the users or groups that will be allowed to access the shared folders on the storage system. If you leave the organizational unit name blank, you can browse the entire tree.

User name :  @ADSERVER.DOMAIN.NET

Password :

Organizational unit name :  Example: /Sales

[Back](#) [Next](#)

10. In the **User name** text box, enter the name of a user who has privileges to access the Active Directory tree.  
When accessing the Active Directory server, this name will be appended with the fully qualified domain name shown on this page.
11. In the **Password** text box, enter the password associated with the specified user name.
12. If you want to specify the name of the organizational unit that contains the users and groups that will be able to access shared folders on the storage system, enter the name in the Organizational unit name text box. The character limit is 256 characters. This unit must not have more than 100 subunits, and the name must be preceded by a forward slash, such as /Sales.

**Note:** The name of the organizational unit cannot contain a slash. For example, if the name is **Sales/Marketing**, you must either specify a different organizational unit name, leave the name blank, or change the name of the organizational unit on the Active Directory server.

If you omit an organizational unit name here, you can browse the Active Directory tree on the next page. However, if the tree has more than 100 subunits or more than 128 users or groups, an error message displays, and you must specify an organizational unit name.

The **Active Directory Tree** page displays.

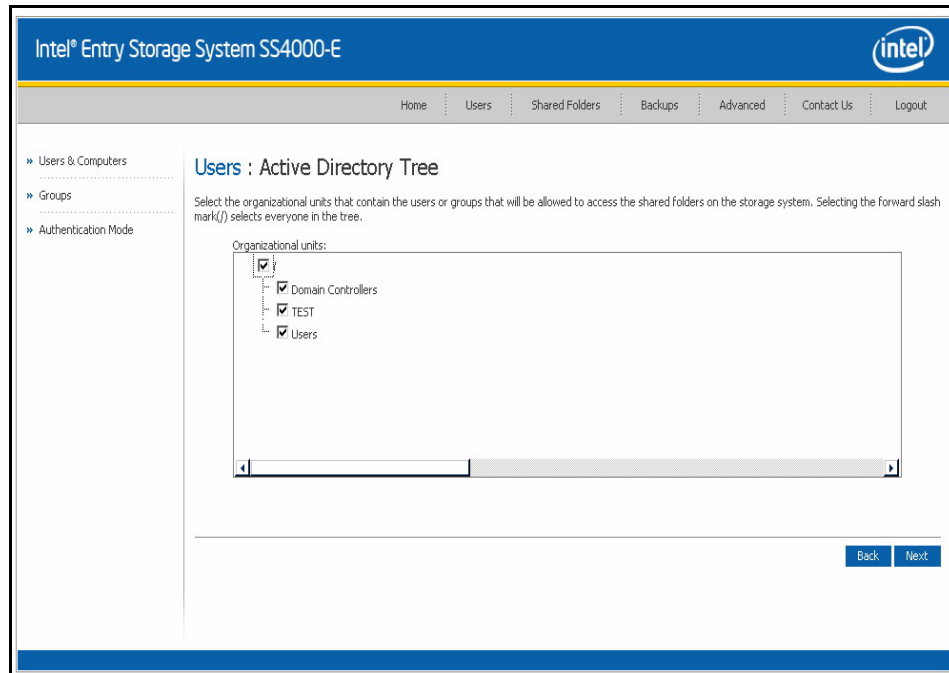

**Note:** If the storage system time and Active Directory server time differ by more than five minutes, an error message displays. You must adjust the storage system time, time zone, or both to ensure that they match as described in [“Changing the System Settings” on page 66](#).

13. Select the organizational units that contain the users or groups that are allowed to access the shared folders on the storage system, and then click **Next**.

**Note:** Once the organizational units are entered, you cannot change them, so make your selection(s) carefully. You can select the root of all the organizational units to get a listing of every user in every unit. If you do setup a organizational unit and need to change it, you can switch to local mode and then re-join the domain. However, this requires setting up the user rights to all shared folders again.

You must select at least one organizational unit. Selecting the forward slash mark (/) selects everyone in the tree.

**Note:** Your storage system supports 256 users and 128 groups. If the selected organizational unit exceeds these maximums, the excess users or groups will not be added to the storage system.

The **Active Directory Administrator Login** page displays.

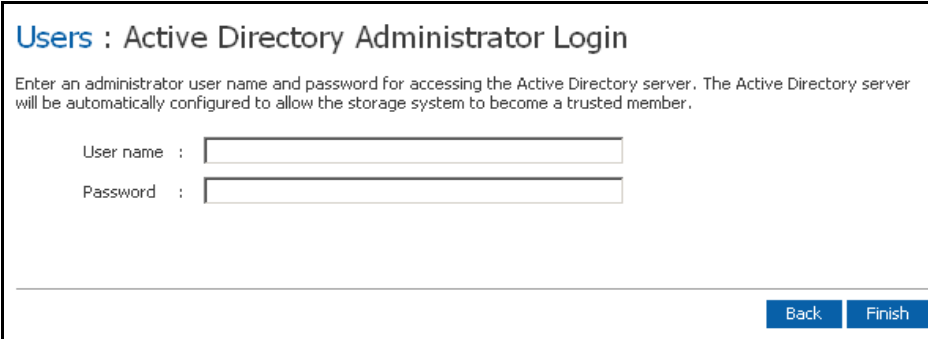

**Users : Active Directory Administrator Login**

Enter an administrator user name and password for accessing the Active Directory server. The Active Directory server will be automatically configured to allow the storage system to become a trusted member.

User name :

Password :

[Back](#) [Finish](#)

14. In the **User name** text box, enter an administrator user name for accessing the Active Directory server.

This account will be used to automatically configure the Active Directory server to allow the storage system to become a trusted member and communicate directly with that server. It is used only when setting up this relationship.

15. In the **Password** text box, enter the password associated with the specified user name, and then click **Finish**.

All the current users and groups associated with the selected organizational unit are imported into the storage system and display on the **Users & Computers** and **Groups** pages. At this point, you can assign these users and groups to shared folders as described in “[Assigning Users to Shared Folders](#)” on page 56.

## Modifying the Active Directory properties

If your storage system is using Active Directory authentication mode, **Active Directory Properties** displays in the left pane when you click **Users** in the navigation bar. Click **Active Directory Properties** to change the IP address of your primary or secondary Active Directory server, the user name or password for browsing the Active Directory tree, or how frequently the storage system should synchronize with the Active Directory server.

To modify the Active Directory properties:

1. In the navigation bar, click **Users**.
2. In the left pane, click **Authentication Directory Properties**.

This item displays only if you are currently using Active Directory authentication mode. To determine which mode you are currently using, click **Authentication Mode** in the left pane and observe the mode specified in the right pane.

When you click **Authentication Directory Properties**, the **Authentication Directory Properties** page displays.

**Users : Update Authentication Mode**

You can change the IP address of your Active Directory server, the user name and password for browsing the tree, and how frequently the storage system should synchronize with the Active Directory server.

You must periodically synchronize the storage system with the Active Directory server to obtain new users, remove deleted users, or update passwords.

Domain Name : DOMAIN.COMPANY.NET

Primary server IP address :  (ServerName)

Secondary server IP address :

User name :  @DOMAIN.COMPANY.NET

Password :

3. Make the desired changes, if any, and click **Apply**:

<b>To change this</b>	<b>Do this</b>
The IP address of the primary Active Directory server	In the <b>Primary server IP address</b> text box, enter the IP address of your primary Active Directory server. You cannot use the server's name.  <b>NOTE:</b> The new server must reside in the same domain as the original server. To change domains, you must change the authentication mode as described in " <a href="#">Changing Authentication Mode</a> " on page 48.
The IP address of the secondary Active Directory server	In the <b>Secondary server IP address</b> text box, enter the IP address of your secondary Active Directory server. You cannot use the server's name.  <b>NOTE:</b> The secondary server must reside in the same domain as the primary server.
The user name or password for browsing the Active Directory tree	In the <b>User name</b> text box, enter the name of a user who has privileges to access the Active Directory tree.  In the <b>Password</b> text box, enter the password associated with that user name.  This user name and password will be used to obtain new user and group information from the Active Directory server at every synchronization.

## Synchronizing the Storage System and Active Directory Server

If you add a new user or group to the Active Directory server, you must wait until the next synchronization before assigning that user or group to a shared folder. You should also do this if a user's password changed on the Active Directory server and the user can no longer access shared folders on the storage system.

To synchronize the storage system and Active Directory server:

1. In the navigation bar, click **Users**.
2. In the left pane, click either **Users & Computers** or **Groups**.
3. Click **Synchronize**. The page displays the progress of the synchronization.

### Notes:

- Your storage system supports 128 users and 128 groups. If the selected organizational unit on your Active Directory server currently exceeds the maximum, the excess users or groups will not be added to the storage system.
- If the clocks of the storage system and the Active Directory server differ by more than five minutes, errors will occur when the two systems synchronize. You must adjust the storage system time, time zone, or both to ensure that they match as described in [“Changing the System Settings” on page 66](#).
- It is recommended that you configure both the storage system and the Active Directory server to set their clocks from a common Network Time Protocol (NTP) server.  
For information about setting the storage system time or using an NTP server, see [“Changing the System Settings” on page 66](#).

## Managing Shared Folders

When you click **Shared Folders** in the navigation bar, the page displays a list of shared resources along with the size of each folder. \

Select	Shared Name	Size	Used Percentage
<input type="radio"/>	Finance	14.99 GB	0 %
<input type="radio"/>	Marketing	9.99 GB	0 %
<input type="radio"/>	homes (User Home Folder)	195 MB	0 %
<input type="radio"/>	public	195 MB	0 %
<input type="radio"/>	usbdisk1	0 MB	0 %
<input type="radio"/>	usbdisk2	0 MB	0 %

The list includes both shared folders and USB devices. Click Shared Assignments in the left pane to see a list of the users and groups that have access to each shared folder. For groups, the group name is preceded by an @ symbol in the **Users with access** list.

The **Shared folders** list includes a NAS share called **homes** as well as **usbdisk1** and **usbdisk2**, whether or not any USB disks have been connected to the storage system.

You can create additional shared folders and delete them at any time. For both shared folders and USB disks, you can change which users can access them and what they can do with the subfolders and files there.

## Deleting a Shared Folder

Once you have created a shared folder, you can remove it at any time. When you delete a shared folder, any users who are currently accessing it are immediately disconnected from it.

**Caution:** *Deleting a shared folder deletes all the subfolders and files in that shared folder. If you want to delete only selected subfolders or files, access the shared folder as described in “Accessing shared folders” on page 79 and delete the desired items.*

### Notes:

- You cannot delete the **public** or the **homes** folder.
- You cannot delete the contents of a USB disk using the **Shared Folders** page. To delete its contents, you must give yourself read/write access to that disk as described in “Managing Shared Folders” on page 54, access the disk as described in “Accessing shared folders” on page 79, and then delete the desired folders and files.
- To remove the USB disk from the storage system, use the Manager to disconnect it as described in “Disconnecting USB Devices” on page 65. Then physically unplug the USB disk from the storage system.  
*Even after you physically unplug the USB disk, it remains in the **Shared folders** list. This ensures that you don't have to re-assign users if you later reconnect the USB disk.*

To delete a shared folder:

1. In the navigation bar, click **Shared Folders**.
2. In the **Shared folders** list, select the shared folder that you want to delete.
3. Click **Remove**.
4. When prompted to confirm the deletion, click **OK**. The shared folder no longer displays in the **Shared folders** list, and all associated subfolders and files are deleted.

## Assigning Users to Shared Folders

1. In the navigation bar, click **Shared Folders**.
2. Select **Shared Assignments** in the left pane. The **Shared Folders: Shared Assignments** page displays:

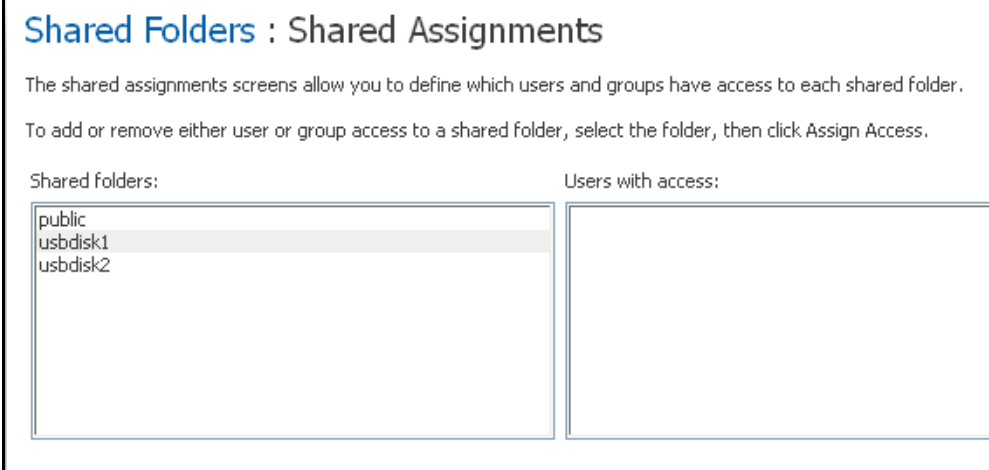

**Note:** The **Shared folders** list includes **usbdisk1** and **usbdisk2**, whether or not any USB disks have been connected to the storage system.

3. In the **Shared folders** list, select the shared folder or USB disk to which you want to assign access or whose user access you want to change.
4. Click **Assign Access**. The **Shared Folders** page displays, listing users and groups.

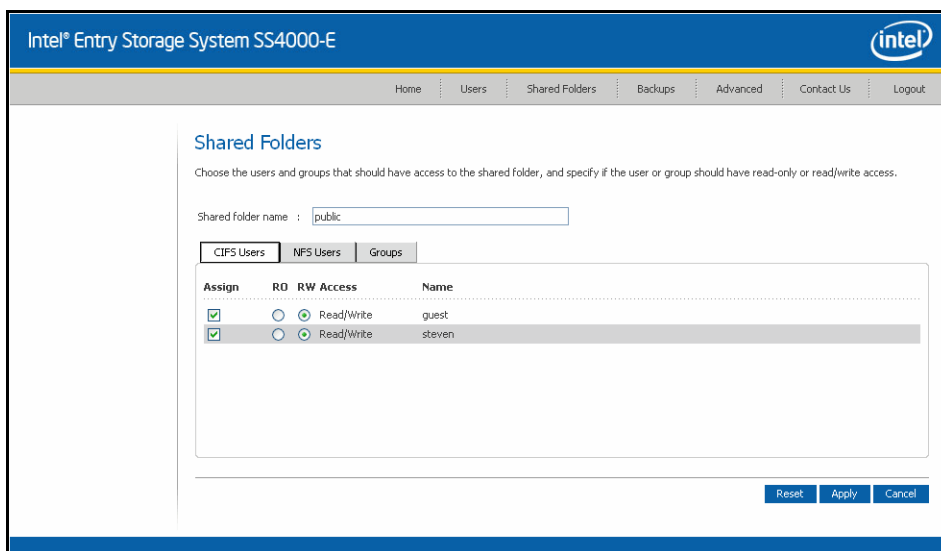



5. Select the user that you want to assign and/or change the access level. You may select either the **CIFS**, **NFS** or **GROUP** tab. Although you can choose only one user type at a time, you can assign multiple user types to the same shared folders.
6. Select the radio button for either **RO** (read only) or **RW** (read/write) access. You can specify which users can access any shared folder or USB disk, as well as setting their level of access.

To do this	Do this
Allow selected users to access to the shared folder or USB disk	<p>Click the check box next to the user(s) name and change their access,</p> <p>Users with read-only access can only view the files in the shared resource; users with read/write access can view, add, modify, and delete folders and files in the shared resource.</p> <p>If you wish to cancel the selection, click the check box again to remove the check.</p>
Unassign user access	Deselect the check box next to the user's name and click Apply.

For any shared folder or USB disk, you can specify which users can access it and what level of access they have.

When you add a user to the list of authorized users for a shared folder or USB disk, that change takes effect immediately. However, if you remove a user from the list of authorized users, or if you change the user's access rights, the change does not take effect until that user disconnects from the shared folder or USB disk, or shuts down the computer.

For example, the user Alice might have read/write access to the Budget shared folder. If Alice is currently connected to that shared folder and you subsequently remove her from the list of authorized users or change her access level to read-only, she will continue to have read/write access to that folder until she disconnects or shuts down her computer. The next time she connects, she will either not have access if she was removed from the list of authorized users, or she will be able to only view the files there if her access level was changed.

**Notes:**

- *Linux users and Mac users who are not using OS X access shared folders using NFS. In this environment, access to shared folders is given to entire computers, not to individual users of those computers. However, in Windows and Mac OS X environments, each computer user can have individual access to a shared folder.*
- *If you created groups, as described in "Adding a Group" on page 44, you can perform this step with the **Group Tab**. This tab displays all groups. For example, if you created a group named Group1, and added User2 and User3 to that group, by default, none of them will be assigned the access to the shared folder. Select Group1 and click RO (Read-Only). User2 and User3 are not assigned the access. This allows you to specify unique access rights for those users. You could select User3 and click RW (Read/Write). This would mean that everyone in Group1 would have read-only access to the shared folder except User3, who would have read/write access to it.*

7. When finished, click **Apply**.

**Note:** Click **Cancel** to negate the shared folder assignments or **Reset** the current shared folder.

To assign users of a different type, repeat this procedure, selecting the other user type in the step 5.

## Managing Backups

Once the users have used Intel® Client Backup and Recovery to back up their computer hard disks to the storage system as described in [Chapter 5, "Protecting Local Disks,"](#) beginning on page 89, the **Backups** page displays a list of each computer that has done this, the size of each protected disk, the date and time of all available backups, and the backup disk ID. The backup disk ID is the number used to identify the backup on both the storage server and on the **Status** page in the Intel® Client Backup and Recovery software.

### Backups

Windows users can protect their local hard disks by creating backups on the storage system. This feature must be licensed on each computer that you want to protect. To acquire additional licenses for the DiskSafe Express client or other upgrades/products, please open the Help/About menu of the DiskSafe Express client.

Using this screen, you can delete all the backups of a selected disk or delete both the client and all backups of all disks for that client.

Protected disks					
Select	Computer Name	Select	Disk Size	Backup Dates	Backup Disk ID
<input type="radio"/>	SBDCLIENT	<input type="radio"/>	102 MB	7/6/2006 12:18:26 PM	3
		<input type="radio"/>	9.77 GB	7/6/2006 12:50:51 PM	4

Recovery passwords

To restore a protected disk using the recovery CD or to boot remotely, you must provide a password.

When protecting a disk, each user enters the desired password. However, you can change it here. For each computer, enter the password that you want to use (12-16 characters). This password will be used for all protected disks at this computer.

**Computer name:** 
**Recovery password:**

Remote boot

The backup for booting remotely must have been created after remote boot was enabled on the client.

**Computer name:** 
**MAC address:** 
**Backup for booting remotely:**

If a user ever has to recover a disk using the recovery CD or remotely boot from a backup on the storage system, the user is prompted for a password to do so. The user had to provide this password when protecting the disk. However, if the user forgets it, you can reset the password using the Manager. For information about recovering a disk using the recovery CD, see [“Recovering a System Disk Using the Recovery CD” on page 117](#). For information about booting remotely, see [“Recovering a System Disk While Booting Remotely” on page 122](#).

For booting remotely, you can also specify the MAC address to use if you want to remotely boot a computer using a different computer’s backup, and the backup to boot from.

In addition, when a user removes protection for a disk, the existing backups are not deleted. The user can re-use the allocated space for new backups, or you can delete those backups manually using the Manager.

## Changing the Recovery Password

To change the recovery password:

1. In the navigation bar, click **Backups**.
2. In the **Computer name** list in the **Recovery passwords** group box, select the name of the computer whose recovery password you want to change.
3. In the **Recovery password** text box, type the password to use. This password must be 12-16 characters long.
4. Click **Change Password**
5. When the confirmation message displays, click **OK**.

The user must provide this password when recovering a disk from this storage system using the Recovery CD or when remotely booting from a backup on the storage system.

## Configuring Remote Boot

Normally, when you enable remote boot for a client computer as described in [“Enabling Remote Boot” on page 111](#), no additional action is necessary on the storage system. However, if you want to remotely boot one computer from another computer’s backup, you must change the MAC address. For example, if Computer1 has been infected by a virus, and all of its backups are also infected, you might want to boot Computer1 from one of Computer2’s backups and recover that disk to Computer1. To do this, you must change the MAC address associated with Computer2.

**Note:** *If you try to recover one computer from another computer’s backup, both computers must have identical hardware. Otherwise, the recovered files do not operate properly.*

You can also specify which backup to remotely boot from. By default, you always boot from the latest backup. You can boot from an earlier backup but no matter which backup you boot from, you can recover only the latest backup.

To configure remote boot:

1. In the navigation bar, click **Backups**.
2. In the **Computer name** list in the **Remote boot** group box, select the name of the computer whose backup you want to remotely boot from.
3. If you are remotely booting the computer from its own backup, do not change the **MAC address**. However, if you are booting a different computer from the selected computer's backup, enter the MAC address of the NIC of the computer that you want to remotely boot in the **MAC address** text box.

Remote boot must have been previously enabled on that computer.

4. From the **Backup for booting remotely** list, select the time and date of the backup that you want to remotely boot from.

To always boot from the most recent backup, select **Latest backup**.

An asterisk (\*) identifies the backup that is used for booting remotely.

**Notes:**

- *You can remotely boot only from backups that were created after remote boot was enabled on the client computer.*
- *If the selected backup is deleted to make room for newer backups, the most recent backup is used for booting remotely.*

5. Click **Apply Boot Info**.
6. When the confirmation message displays, click OK.

If you changed the backup for booting remotely, an asterisk displays next to the selected backup.

## Deleting a Backup

You can delete all backups for a given disk, but you cannot delete just an individual backup from a specific date and time.

**Note:** *If you delete all backups of all disks for a particular computer, that computer no longer displays on the Backups page. However, that computer name remains in the storage system and counts toward the total number of computers that are allowed to back up to the storage system. If you want to delete all backups of all disks and the computer name, see “Deleting a Client” on page 61.*

To delete all backups of a disk:

1. In the navigation bar, click **Backups**.
2. Select the radio button adjacent to the disk whose backups you want to delete in the second **Select** column.
3. Click **Delete Backup**.
4. When prompted to confirm the deletion, click **OK**.

The disk no longer displays on the **Backups** page, and all backup versions are deleted. If only one disk was protected, the computer name disappears from the page.

***Note:** If you delete a backup and the user did not previously remove protection for that disk, when the user subsequently accesses Client Backup and Recovery, the **Status** page indicates that the backup of the protected disk is offline. To back up the disk once again, the user must remove protection and then protect the disk again. For more information, see “[Removing Protection](#)” on page 126 and “[Protecting Your Disks](#)” on page 98.*

## Deleting a Client

If you remove the Intel® Client Backup and Recovery software from a particular computer, or if you change the computer name, the original computer name remains on the storage system and counts toward the total number of computers that are allowed to back up to the storage system. To both delete all backups of all disks for a particular computer and the computer name, you must delete the client.

To delete a client:

1. In the navigation bar, click **Backups**.
2. Select the radio button to the left of the computer whose backups and computer name you want to delete from the storage system in the first **Select** column.
3. Click **Delete Client**.
4. When prompted to confirm the deletion, click **OK**. The disk no longer displays on the **Backups** page, and all backup versions are deleted. If only one disk was protected, the computer name shows from the page as well.

***Note:** If you delete a client and the user did not previously remove protection for that disk, when the user subsequently accesses the Intel® Client Backup and Recovery software, the **Status** page indicates that the backup of the protected disk is offline. To back up the disk once again, the user must remove protection and then protect the disk again. For more information, see “[Removing Protection](#)” on page 126 and “[Protecting Your Disks](#)” on page 98.*

## Setting Up e-mail Alerts

The **Alerts** feature is one of the **Advanced** menu options that allows you to set up the storage system to notify up to three people via e-mail if a problem occurs. For example, if one of the disks fails, or if insufficient space is available for creating new files or performing a backup.

### Advanced : Alerts

Specify whether or not you want the storage system to send out an e-mail notification when an error or warning occurs. If you select this option, enter information about your e-mail server, e-mail sender and up to three e-mail addresses that should receive the notification.



You can specify a name for your SMTP server only if your network has a DNS server. In addition, you might also have to modify the network settings (such as the gateway or DNS server to use). To configure these settings, click Network in the left pane.

Send e-mail notifications.

**E-mail server**

SMTP server name or IP address : localhost

SMTP server authentication

User name : username

Password :

Enter a user name and password for your e-mail server only if this is required by your e-mail server.

**E-mail sender**

Sender e-mail address : root@localhost

**E-mail recipients**

First e-mail address : admin@company.com

Second e-mail address :

Third e-mail address :

To take advantage of this feature, you must have access to an SMTP e-mail server either within your own network or through an Internet service provider.

**Note:** *The e-mail is sent within five minutes of the event. If the problem is fixed before the email is sent, the alert is not sent.*

To set up e-mail alerts:

1. In the navigation bar, click **Advanced**.
2. Specify whether or not the storage system should send e-mail notifications when a problem occurs by selecting or clearing the **Send e-mail notifications** check box.

If you select this option, you must provide the fully qualified domain name or IP address of your e-mail server and at least one email address.

If you clear this option, e-mail notifications is not sent, and all the related fields on this page display dimmed. However, if you previously entered information on this page, that information is retained so that you can easily re-enable e-mail notifications later. If you clear this option, you do not have to complete the rest of this procedure; simply click **Apply**.

3. In the **SMTP server name or IP address** text box, enter the fully qualified domain name or IP address of your e-mail server.
4. Specify where or not your e-mail server requires authentication by selecting or clearing the **SMTP server authentication** check box.

If you select this option, you must enter a user name and password for logging into that server in the **User name** and **Password** text boxes.

If you clear this option, no authentication is performed.

5. If your e-mail server cannot use the default sender e-mail address (`root@localhost`), or if you want the individuals who receive e-mail notifications to be able to reply to the alert, enter the address that you want to display as the return address in the **Sender e-mail address** text box.

For example, you might enter your own e-mail address, such as `MyName@MyCompany.com`.

6. In the **First e-mail address** text box, enter the e-mail address of an individual who should receive e-mail notifications when a problem occurs.

The e-mail address can be up to 128 characters long and must include the @ symbol, such as `MyName@MyCompany.com`.

7. If you want e-mail notifications to be sent to other individuals as well, enter the appropriate e-mail addresses in the **Second e-mail address** and **Third e-mail address** text boxes.

8. Click **Apply**.

9. When the confirmation message displays, click **OK**.

10. To confirm that the configuration is correct, click **Test E-mail**, and click **OK** on the confirmation message.

This sends a test message to the specified recipients. If they do not receive the test message, make sure that all the entries on this page are correct. You might also have to modify the network settings, such as the gateway. For information about changing the network settings, see [“Changing the Network Settings” on page 68](#).

## Upgrading the Firmware

The **Firmware** option is available from the **Advanced** tab in the top navigation bar. The Firmware screen displays the current version of the firmware that is installed on your storage system. It also allows you to upgrade it if newer firmware becomes available.

**Advanced** : Firmware

You must enter the administrator password to upgrade the firmware.

**Current version** : fs-bc - 1.2-b504

Firmware file :

Administrator password :

---

For additional security, you must enter your administrator password in order to upgrade the firmware. In addition, you should backup your data before upgrading the firmware.

### **Caution:**

- *When you upgrade the firmware, the storage system restarts, and access to the Manager is interrupted. Users cannot access the shared folders while the system restarts. If users have shared files open, data might be lost. Be sure to have all users save their changes and close any open files before you upgrade the firmware.*
- *Restarting the storage system when a backup is occurring does not have adverse effects; the backup resumes automatically when the storage system resumes operation. However, restarting the storage system when a disk is being recovered can potentially corrupt the operating system, and you will need to recover the system disk using the recovery CD, or if the system disk was not protected, re-install the operating system. Upgrade the firmware only when recovery is not occurring.*
- *You cannot use the advanced interface to upgrade from version 1.0, 1.1, 1.2, or 1.3 to version 1.4. Upgrading to version 1.4 is a data-destructive process due to the structure of the firmware and the addition of support for drivers greater than 500 GB. Back up your data and see the version 1.4 release notes for upgrade information.*

After reading the above cautions, to upgrade the firmware:

1. In the navigation bar, click **Advanced**.
2. In the left pane, click **Firmware**.
3. In the **Firmware file** text box, enter the path and file name for the firmware package, such as **D:\fs20060921.pkg**, or click **Browse** and select the file from the displayed list.
4. In the **Administrator password** text box, enter the password that you use for logging in to the Manager.
5. Click **Upgrade**.
6. When the confirmation message displays, click **OK**.



## Disconnecting USB Devices

The **USB** page displays a list of all USB devices that are currently attached to the storage system, including the type of device it is, the manufacturer, and the name. USB disks are identified by the names **usbdisk1** and **usbdisk2**. These names cannot be changed.

### Advanced : USB

To remove a USB device, select the checkbox next to the device and click **Disconnect** before you unplug the device from your system.

To detect a newly attached USB device or to remove from this list a USB device that has been unplugged, click **Scan**.

Select	Type	Manufacturer	Shared Resource
<input type="checkbox"/>	Storage	N/A	usbdisk2

When you plug a USB device into the storage system, the storage system automatically detects it and adds that device to the **USB** page. You might need to click **Scan** to update the display.

However, when you want to unplug a USB device from the storage system, you must first use the Manager to disconnect it. This prevents data corruption and other potential problems with the device. Once the USB device has been disconnected via the Manager, you can unplug it.

To disconnect a USB device:

1. In the navigation bar, click **Advanced**.
2. In the left pane, click **USB**.
3. In the list of USB devices, select the device(s) that you want to disconnect.
4. Click **Disconnect**.
5. When the confirmation message displays, click **OK**. You can now unplug the USB device.

**Note:** *If you inadvertently disconnect a USB device that you want to retain, unplug it from the storage system, plug it back in, and then click **Scan**. This reactivates the USB device.*

*Since the USB device always remains on the **Shared Folders** page, any user assignments are always retained.*

## Changing the System Settings

The **System** page displays the settings that you specified when you initially configured the storage system, such as the storage system name, and the current date and time.

### Advanced : System

You can change basic system settings as well as the password for logging in.

Changing the storage system name will restart the system. The users will not be able to access the shared folders or perform backups or recovery during this time.

System settings

Storage system name :

Date :  /  /  (Month / Day / Year)

Time :  :  :  (Hour : Minute : Second)

Time zone :

NTP server name or IP address :

Administrator login

Administrator name :

Password :

Confirm password :

 The password cannot exceed 24 characters.

In local authentication mode, you can change any of these settings at any time. In Active Directory authentication mode, you can change all of the settings except the storage system name. You can also change the administrator name and password used for logging in to the Manager.

To change any of the system settings:

1. In the navigation bar, click **Advanced**.
2. In the left pane, click **System**.

3. Make the desired changes:

To change this	Do this
The storage system name	<p>In the <b>Storage system name</b> text box, enter the new name to use for the storage system.</p> <p>This name can be up to 15 characters long and can include letters, numbers, and hyphens.</p>
The system date, time, or time zone	<p>In the <b>Date</b> fields, enter or select the desired month, date, and year.</p> <p>In the <b>Time</b> field, enter or select the desired hour, minute, and second.</p> <p>In the <b>Time zone</b> list, select the desired time zone.</p>
Network Time Protocol (NTP) server name or IP address	<p>In the <b>NTP server name or IP address</b> text box, enter the name or IP address of the NTP server from which the storage system should set its time.</p> <p>The storage system synchronizes its time with the NTP server every hour.</p> <p>You can use a name only if it is resolvable.</p>
The administrator name or password	<p>In the <b>Administrator name</b> text box, enter the user name to use for logging in to the Manager.</p> <p>In the <b>Password</b> and <b>Confirm password</b> text boxes, enter the password to use for logging in to the Manager.</p> <p>The user name and password are case-sensitive.</p>

4. Click **Apply**.

5. When the confirmation message displays, click **OK**.

## Changing the Network Settings

The **Network** page displays the network settings that were set when you initially configured the storage system. Only the first Ethernet port was configured during setup. The second uses its default settings unless you change them here.

### Advanced : Network

The network settings determine how this storage system interacts with your network, and whether or not it also acts as a DHCP server or FTP server.

 If you change the IP address, you must re-access the Manager using the new IP address after you click Apply. In addition, any changes to the settings on this screen might temporarily interrupt user access to the storage system.

Workgroup :

**Port 1**

MAC address: 00:90:08:07:43:AF

Get an IP address automatically

Use this IP address:

IP address :  ,  ,  ,

Subnet mask :  ,  ,  ,

Gateway IP address :  ,  ,  ,

**DNS server settings**

Preferred DNS server :  ,  ,  ,

Alternate DNS server :  ,  ,  ,

**DHCP server settings**

Enable DHCP server

Starting IP address :  ,  ,  ,

Ending IP address :  ,  ,  ,

 You can enable the storage system to be a DHCP server only if this port uses a fixed IP address.

Jumbo Frames :  Bytes

**Port 2**

MAC address: 00:90:08:07:43:B0

Get an IP address automatically

Use this IP address:

IP address :  ,  ,  ,

Subnet mask :  ,  ,  ,

Jumbo Frames :  Bytes

**FTP server settings**

Enable FTP server

[Apply](#)

You can change these settings at any time.

**Note:** Changing the IP address or subnet mask can have several effects:

- Access to the Manager is temporarily disrupted. If you access the Manager using a Web browser and an IP address, you need to use the new IP address. In addition, if you added the storage system's IP address to a local **hosts** file or DNS server, you must update the IP address in those resources.
- Users who accessed the shared folders using the previous IP address is disconnected and must access them again using the new IP address as described in [“Accessing Shared Folders” on page 79](#).
- Users running Intel® Client Backup and Recovery must restart that application. If a backup or recovery was in progress and did not complete successfully, perform the action again.

You can also configure the storage system to act as a DHCP server. In other words, the storage system can assign IP addresses to other computers in your network, simplifying the network configuration of each individual system.

In addition, your storage system can act as an FTP server. This allows all Windows/Mac OS X users to use a Web browser to access the **public** folder. For more information, see [“Accessing Shared Folders using FTP” on page 85](#).

To change any of the network settings:

1. In the navigation bar, click **Advanced**.
2. In the left pane, click **Network**.
3. Make the desired changes:

To change this	Do this
The workgroup to which the storage system belongs	In the <b>Workgroup name</b> text box, enter the name of the workgroup. This name can be up to 15 characters long.
The IP address(es) used by the storage system	In the <b>Port 1</b> group box, either select <b>Get an IP address automatically</b> to obtain the IP address from your DHCP server, or select <b>Use this IP address</b> and enter the IP address and subnet mask in the subsequent text boxes.  If you select <b>Get an IP address automatically</b> and your network does not have a DHCP server, or if the storage system is directly attached to your computer, the default IP address and subnet mask are used. The default IP address is 192.168.0.101, and the default subnet mask is 255.255.255.0.  If you are using the second Ethernet port, do the same in the <b>Port 2</b> group box.
The IP address of the gateway	If your network includes a gateway, and if the first port on the storage system uses a specified IP address rather than obtaining one from the DHCP server, enter the IP address of the default router in the <b>Gateway IP address</b> text boxes. This is typically the same IP address as the first port, with the last number being 1.  If your network does not include a gateway, or if the first port obtains its IP address from the DHCP server, leave these text boxes blank. If the first port obtains its IP address from a DHCP server, the gateway obtains its IP address from the DHCP server as well.

To change this	Do this
The DNS server to use	<p>If your network includes a DNS server, and if the first port on the storage system uses a specified IP address rather than obtaining one from the DHCP server, enter the primary IP address in the <b>Preferred DNS server</b> text boxes and the secondary IP address in the <b>Alternate DNS server</b> text boxes.</p> <p>If your network does not include a DNS server, or if the first port obtains its IP address from the DHCP server, leave these text boxes blank. If the first port obtains its IP address from a DHCP server, the DNS server IP address is obtained from the DHCP server as well.</p>
The IP address(es) used by the storage system	<p>In the <b>Port 1</b> group box, either select <b>Get an IP address automatically</b> to obtain the IP address from your DHCP server, or select <b>Use this IP address</b> and enter the IP address and subnet mask in the subsequent text boxes.</p> <p>If your storage system has two Ethernet ports and you are using the second one, do the same in the <b>Port 2</b> group box. This group box does not appear if your storage system supports only one Ethernet port.</p>
The DHCP settings	<p>If you want to use the storage system as a DHCP server, in the <b>Port 1</b> group box, select <b>Use this IP address</b> and enter the IP address and subnet mask in the subsequent text boxes.</p> <p>Then select the <b>Enable DHCP server</b> check box, enter the beginning IP address in the <b>Starting IP address</b> text boxes, and enter the last IP address in the <b>Ending IP address</b> text boxes.</p> <p>For example, if the <b>Starting IP address</b> is 192.168.0.103 and the <b>Ending IP address</b> is 192.168.0.107, the storage system allocates the IP addresses 192.168.0.103, 192.168.0.104, 192.168.0.105, 192.168.0.106, and 192.168.0.107 to the first five computers that try to obtain their IP addresses from the storage system. As soon as one of those computers shuts down or otherwise loses its network connection, that IP address is assigned to the next computer that tries to obtain its IP address from the storage system.</p> <p>If you do not want to use the storage system as a DHCP server, clear the <b>Enable DHCP server</b> check box. If <b>Get an IP address automatically</b> is selected, you cannot use the storage system as a DHCP server.</p>
The packet size for transferring data	<p>Specify whether or not to transfer larger data packets between the storage system and the computers in your network by selecting or clearing the <b>Jumbo Frames</b> check box.</p> <p>If you clear this option, the storage system uses 1514-byte packets. If you select this option, you can specify a larger packet size from 1514 to 9014 bytes.</p> <p><b>NOTE:</b> Using jumbo frames allows you to transfer data more quickly. However, you can select this option only if your network, Ethernet switch, and the network interface cards (NICs) on the computers in your network support the specified packet size. To determine whether you can use jumbo frames, see the documentation for those components.</p>
The FTP settings	<p>If you want to use the storage system as an FTP server, select the <b>Enable FTP server</b> check box. If you do not want to use the storage system as an FTP server, clear this option.</p> <p>For information about accessing the storage system using FTP, see <a href="#">“Accessing Shared Folders using FTP” on page 85</a>.</p>

4. Click **Apply**. When the confirmation message displays, click **OK**.

**Note:** *If you changed the IP address of the storage system, you must now access the Manager using the new IP address.*

## Reconfiguring Your Storage System Disks

The **Disks** page displays information about all the hard disks that are installed in your storage system:

### Advanced : Disks



Reconfiguring the disks will delete all user information and all data on all the disks.

Expanding the disk space allocated to shared folders has no effect on your existing data or user access.

Disk configuration: RAID 5 (NORMAL)

Slot	Model	Serial Number	Size	Disk Status	Hotplug Indicator
1	ST3250823AS	3ND05VJH	232.89 GB	RAID 5	YELLOW
2	ST3250823AS	3ND05EDM	232.89 GB	RAID 5	YELLOW
3	ST3250823AS	3ND0551R	232.89 GB	RAID 5	YELLOW
4	-	-	-	-	-

Refresh

Disk configuration settings

Administrator password :

Reconfigure Disks

This page includes the following details:

- The disk configuration that is, whether the disks use a linear or RAID configuration, and the RAID level.
- The overall status of the disks:
  - **Normal**—All the disks are working properly.
  - **Degraded**—One or more disks have failed but all the data is still available.
  - **Failed**—The storage system has stopped working properly.
- The slot where each hard disk resides.
- The model number, serial number, and size of each hard disk.
- The current status of each disk:
  - **Linear** or **RAID *n***—The disk is working properly as part of the specified configuration.
  - **New**—The disk has been added to the storage system but is not currently being used.
  - **Spare**—The disk is acting as a spare disk for the RAID.
  - **Rebuilding**—The disk is being rebuilt such as when a failed disk is replaced.
  - **N/A**—The disk is detected but not available for use, such as when it has failed.

- The hot-plug indicator:
  - **RED**—Removing the disk causes the RAID to fail.
  - **YELLOW**—Removing the disk causes RAID degradation.
  - **GREEN**—Removing the disk does not affect the RAID.

**Note:** Whenever you add or remove a disk from the storage system, you must click **Refresh** to update the hot-plug indicator.

For detailed information about RAID configurations and how adding, removing, or swapping disks affects the storage system, see “Levels of RAID” on page 169.

You can change the disk configuration or amount of storage space that is allocated for shared folders at any time. However, for additional security, you must enter your administrator password to be able to make these changes.

## Expanding the Shared Storage

The disk space on your storage system is divided into two portions. One portion is for shared folders; the other is for backups of your computer disks. The **Storage Status** view on the **Home** page shows how much disk space is currently allocated for shared folders, how much is used by backups, and how much is available for either.

You can expand the amount of disk space allocated for shared folders (as long as free disk space is available), but you cannot reduce it without reconfiguring your disks and losing all your data. Therefore, it is recommended that you allocate the least amount of space for shared folders until all the computer disks that you plan to protect have been backed up to the storage system.

To expand the amount of disk space allocated for shared folders:

1. In the navigation bar, click **Shared Folders**.
2. Select the shared storage you want to expand.
3. Click **Expand**. The **Shared Folders** page displays:

### Shared Folders

Use this screen to expand the shared folder space. Your storage system is divided into two partitions, one for shared folders and one for backups. The maximum amount of shared folder space is 2TB. To allocate additional space, select the Additional disk space button and specify 1GB or higher. .



It is recommended that you limit expansion to 20GB at a time due to the extensive processing time required for large expansions. Once you allocate space for this shared folder, you cannot reduce that amount. Be sure to leave enough space for backups of your computer disks and other shared folders.

Shared folder name :

Current amount of space allocated for shared folder : 9.99 GB

Add maximum available disk space : 344.58 GB

Additional disk space :  GB



4. Select the amount of disk space to allocate. You can choose to allocate the maximum available space or specify any amount. It is recommended that you limit expansion to 20 GB at a time due to the extensive processing time required for large expansions. To allocate additional space, select the Specify disk space button and specify 1 GB or higher. You can specify only whole numbers.

**Note:** *Allocated space is approximate. A small amount will be used by the file system. For example, allocating 200 MB might display as 195 MB on the screen.*

5. Click **OK**.
6. When the confirmation message displays, click **OK**.

## Reconfiguring the Disks

**Caution:** *Changing the disk configuration deletes all user information and all data on the disks.*

*Before you do this, have all the users disconnect from all shared folders, as described in “Disconnecting from Shared Folders” on page 86, and remove protection from all disks as described in “Removing Protection” on page 126.*

*When you are done, you must re-add all users as described in “Adding Users” on page 41, create new shared folders as described in “Creating Shared Folders” on page 35, and protect their disks as described in “Protecting Your Disks” on page 98.*

To change the disk configuration:

1. In the navigation bar, click **Advanced**.
2. In the left pane, click **Disks**.
3. In the **Administrator password** text box, enter your password for logging in to the Manager.
4. Click **Reconfigure Disks**.
5. When the confirmation message displays, click **OK**. The **Disk Configuration** page displays. The options that appear on this page vary, depending on the number of hard disks that are currently installed in the system.

### Advanced : Disk Configuration

Your storage system can have up to four disks. Four disks have been detected. What kind of disk configuration would you like to use?

- Data protection (RAID 5 - three disks minimum)**  
An amount of disk space equal to one disk is used for data protection, and the rest is used for data storage. The data is distributed in such a way that it can be recovered if any one disk fails.
- Data protection, failover (RAID 5+spare - four disks minimum)**  
Three of the disks provide RAID 5 data protection, and the fourth automatically joins the RAID if one of the other three disks fails.
- Data duplication (RAID 10 - four disks minimum)**  
Half of the disk space is used for data storage, and the other half is used for a duplicate (mirror) of that data. If one disk fails, you have a backup copy.
- Better performance, no data protection (RAID 0 - two disks minimum)**  
All the disk space is used for data storage.
- Expandable, no data protection (Linear - one disk minimum)**  
All the disk space is used for data storage, and you can add more disks later without affecting your existing data.

- If you want to add or remove hard disks, do so one at a time and click **Scan** after each action. If you are adding disks, wait until the disk LED is green before you click **Scan**.

To accept the default disk configuration, which provides the best level of data protection available for the number of hard disks currently installed, click **Next**. By default, a linear disk configuration is used for a single hard disk, RAID 1 is used for two hard disks, and RAID 5 is used for three or four hard disks.

If you want to change the disk configuration, select the desired RAID level and then click **Next**. For detailed information about the different RAID levels, see [Appendix A, "Levels of RAID,"](#) beginning on page 169.

- The **Disk Space Distribution** page displays:

**System Setup : Disk Space Distribution**

Your storage system is divided into two partitions, one for shared folders and one for backups. The maximum amount of shared folder space is 2 TB (1 TB=1024 GB). The minimum space requirement is 200 MB. You can allocate more space now or accept the default minimum space allocation. To allocate additional space, select the Specify disk space button and specify 1 GB (1024 MB) or higher. Specify how much space you want to allocate for "public" shared folder and "home" folders.

 Once you allocate a certain amount of space for shared folders, you cannot reduce it. If you plan to back up computer disks to your storage system, it is recommended that you use the minimum amount of disk space for shared folders, back up all the computer disks that you plan to protect, and then expand the space allocated for shared folders. This ensures that adequate space is available for backups.

Available disk space : 934.05 GB

**Home**

Use the minimum amount of space for shared folders (200 MB)

Specify disk space :  GB

**Public**

Use the minimum amount of space for shared folders (200 MB)

Specify disk space :  GB

[Back](#) [Finish](#)

8. Your storage system is divided into several partitions, one for shared folders, one for home folders, and one for backups. The maximum amount of a shared folder space is 2 TB (1 TB=1024 GB). The minimum space requirement is 200 MB. You can allocate more space now or accept the default minimum space allocation. To allocate additional space, select the Specify disk space button and specify 1 GB (1024 MB) or higher. To allocate the maximum available, select the Add maximum available disk space" raid button. After setting the appropriate value, hit OK. The folder is created and the Shared Folders screen will be displayed.

**Note:** *You can expand the amount of disk space allocated for shared or home folders later as long as free disk space is available, but you cannot reduce it without reconfiguring your disks and losing all your data.*

*If you plan to back up computer disks to your storage system, it is recommended that you use the minimum amount of space for shared or home folders, back up all the computer disks that you plan to protect, and then expand the space allocated for shared folders. This ensures that adequate space is available for backups.*

9. When the confirmation message displays, click **OK**. The screen displays the progress of the process:

#### Advanced : Disk Configuration

The system is now being configured. This may take several minutes depending on the disk configuration and the number and size of disks installed.

Please wait until this process is complete.

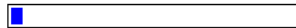

Resetting the storage ... (10%)

When this process is complete, the storage system restarts.

#### Advanced : Disk Configuration

The system is now being configured. This may take several minutes depending on the disk configuration and the number and size of disks installed.

Please wait until this process is complete.

The storage system is rebooting. If the page does not reappear automatically when this process is complete, please close the current browser window and reconnect when the system status LED is solid green and has stopped blinking.

10. Close the browser window.

After the system has restarted, you can access the Manager and re-create your users and shared folders as described in “Adding Users” on page 32 and “Creating Shared Folders” on page 35.

## Viewing System Status Information

When you click **Advanced** in the navigation bar and click **System Status** in the left pane, you can view many of the operational parameters of your storage system, including CPU usage, memory usage, the amount of time that the storage system has been running, the current fan speed, the temperatures of the CPU and disks, the IP address of the gateway, the IP address(es) of the DNS servers in your network, the network settings of your ports, the MAC addresses of your ports, and the speed at which data is being sent and received.

To update the information on this page, click **Refresh**.

### Advanced : System Status

This list displays major system status. You can click Refresh to update it.

System Status			
<b>CPU</b>		<b>Memory</b>	
Busy	57 %	Total	256916 KB
Idle	43 %	Used	74204 KB
		Cache	26208 KB
		Free	182712 KB
<b>Uptime</b>		<b>Hardware</b>	
Uptime (days:hours:minutes)	0:0:18	Fan Speed	1757 RPM
		CPU Temp	53 °C (127.4 °F)
		Disk 1 and 2 Temp	32 °C (89.6 °F)
		Disk 3 and 4 Temp	36 °C (96.8 °F)
<b>Network</b>			
Gateway	---		
DNS Server 1	---		
DNS Server 2	---		
<b>PORT 1</b>		<b>PORT 2</b>	
MAC	00:0E:0C:B2:74:14	MAC	00:0E:0C:B2:74:15
Status	Connected	Status	Disconnected
Address Type	Manually Configured	Address Type	Automatic Private Address
IP	192.168.0.101	IP	---
MASK	255.255.255.0	MASK	---
Jumbo Frames	1514 Bytes	Jumbo Frames	1514 Bytes
Receiving Speed	0.00 KB/s	Receiving Speed	0.00 KB/s
Sending Speed	0.39 KB/s	Sending Speed	0.00 KB/s

Refresh

**Note:** The fan speed changes depending on the temperature of the unit. If the temperature of the CPU reaches or exceeds 85° C (185° F), or if the temperature of any of the disks reaches or exceeds 55° C (131° F), the storage system shuts down automatically.

## Logging Out of the Manager

When you have finished using the Manager, you should log out to ensure that unauthorized individuals do not make changes to the storage system.

To log out:

1. In the navigation bar, click **Log Out**.
2. When the confirmation message displays, click **OK**. The **Log Out** page displays:

### Log Out

You have successfully logged out. Thank you for using our network storage system.

Log In

3. To log back in to the Manager, click **Log In**.

## Shutting Down the Storage System

Press the power button on the unit or shut the system down remotely using the Manager. To shut down using the power button, press and hold the power button for approximately five seconds until the System Status LED starts flashing.

**Caution:** Do not disconnect the power cord while the system is powering down.

The storage system shuts off after a short shutdown period. To ensure that you do not shut down the system accidentally, you must enter your administrator password.

### Advanced : Shut Down

You must enter the administrator password to shut down the storage system.

Use this screen to remotely power down the storage system.

Shutting down the storage system will prevent user access to shared folders and interrupt backup and recovery activities.

Administrator password :

Shut Down

**Caution:** If you shut down the storage system, users can no longer access the shared folders on the storage system. If users have shared files open, data might be lost. Have all users save their changes and close any open files before you shut down the system.

Shutting down the storage system when a backup is occurring does not have any adverse effect; the backup resumes automatically when the storage server is powered on again. However, shutting down the storage system when a disk is being recovered can potentially corrupt the user's operating system. If this happens, the user needs to recover the system disk using the recovery CD or, if the system disk was not protected, re-install the operating system.

To shut down the storage system using the Manager:

1. In the navigation bar, click **Advanced**.
2. In the left pane, click **Shut Down**.
3. In the **Administrator password** text box, enter the password for logging in to the Manager.
4. Click **Shut Down**.

A message displays, indicating that the system is shutting down. Once the storage system shuts down, if you refresh the browser window, it is blank. If you subsequently try to access the Manager, an error message displays, since the storage system is no longer running.

# 4 Working with Shared Folders

---

## Accessing Shared Folders

Once you have added users and created shared folders, as described in [“Adding Users” on page 32](#) and [“Creating Shared Folders” on page 35](#), the users need to perform some simple steps to be able to access those folders. The procedure for doing this varies, depending on the user’s operating system. Each user can access only those shared folders that the user is authorized to access.

### *Notes:*

- If the storage system uses Active Directory authentication mode, and the clocks of the storage system and the Active Directory server differ by more than five minutes, errors will occur when users try to access the shared folders. It is recommended that you configure both the storage system and the Active Directory server to set their times from a common Network Time Protocol (NTP) server. To configure this on the storage system, see [“Changing the System Settings” on page 66](#).
- If you change the IP address of the storage system, users who accessed the shared folders using the previous IP address is disconnected and must repeat the procedures described here using the new IP address.

## Microsoft Windows\* Users

If you are using Microsoft Windows\*, you have two options for accessing shared folders: you can use My Computer/Windows Explorer to map a drive letter to the shared folder, or you can install the Console and use that utility to map a drive letter to the shared folder. The Console must be installed on the same subnet as the storage system. It is not necessary to remember the name of the storage server and shared folders because they are displayed automatically.

## Using My Computer/Windows Explorer

To access a shared folder using My Computer/Windows Explorer:

1. Open My Computer/Windows Explorer.
2. From the **Tools** menu, click **Map Network Drive**. The **Map Network Drive** dialog box appears:

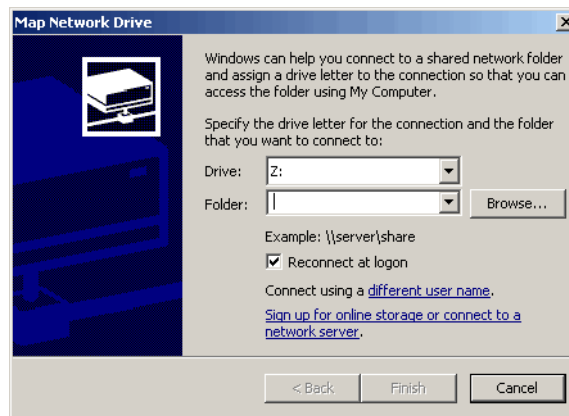

The appearance of this dialog box varies by operating system.

3. In the **Drive** list, select the drive letter that you want to assign to the shared folder.
4. In the **Folder** text box, enter the following:

```
\\storage_system\shared_folder
```

where *storage\_system* is the name or IP address of the storage system and *shared\_folder* is the name of the shared folder. For example, if your storage system's IP address is 192.168.0.101 and the shared folder name is **Photos**, you would enter the following:

```
\\192.168.0.101\Photos
```

**Note:** You can use the storage system name only if your computer is in the same subnet as the storage system, if you added the storage system's IP address and name to your local **hosts** file, or if you manually registered the name with a DNS server in your network.

Alternatively, you can click **Browse** and select the shared folder from the **Microsoft Windows Network**.

5. To automatically connect to this shared folder each time you log on to Windows, select **Reconnect at logon**.

If you clear this option, you must repeat this procedure each time you want to access the shared folder.

6. Click **Finish**.



- If prompted, enter your user name and password for accessing this shared folder, and then click **OK**.

**Note:** *If the user name and password for accessing the shared folder are the same as your Windows user name and password, you are not prompted to provide a user name and password to access the shared folder.*

*In addition, once you provide your user name and password for accessing one shared folder, you are not prompted to provide it again when you access other shared folders to which you have access rights.*

If the storage system uses local authentication mode and the guest user has access to this shared folder, you can use **guest** as both the user name and password.

You can now access the shared folder from My Computer/Windows Explorer.

## Using the Console

To access a shared folder using the Console:

- Install the Console as described in [“Installing the Console” on page 17](#).
- Click **Start > Programs > Storage System Console**.

The Console application window appears:

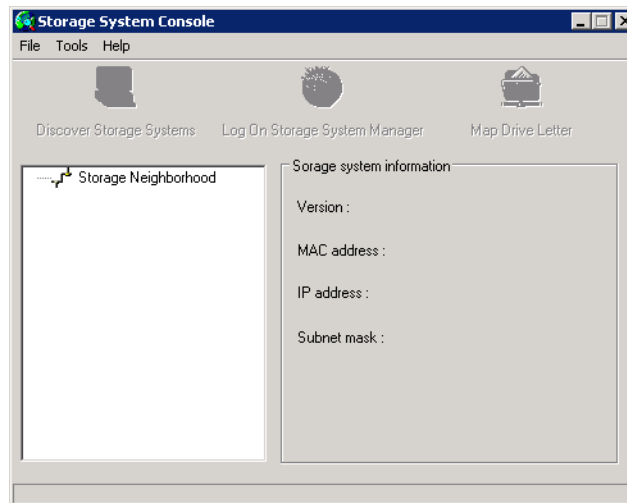

As soon as you start the Console, it automatically scans the network for storage systems. This might take a few minutes. As soon as the scan is complete, the left pane displays a tree view of all the storage systems it found:

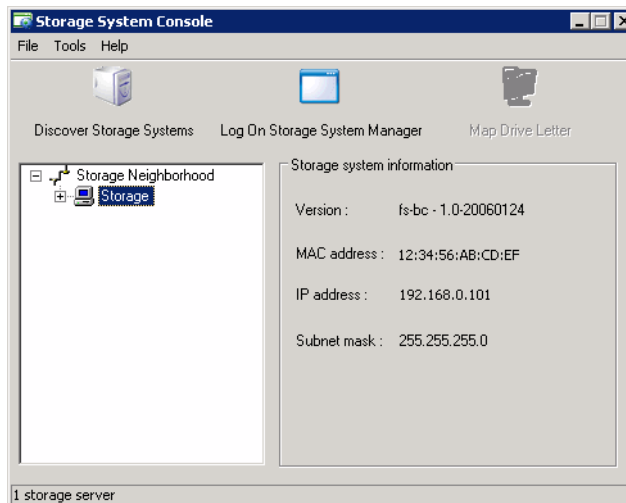

Each storage system has two ports for connecting to the network. If your storage system uses both ports, two items appear in the tree in the left pane, each using the same name. You can identify the IP address used by each port by clicking each item in the tree and observing the **IP address** area in the right pane.

**Note:** *If you connect a storage system to the network after the Console has already scanned it, or if you change the IP address of the storage system, you must click **Discover Storage Systems** to scan the network again and update the tree in the left pane.*

3. In the left pane, double-click the name of the storage system that contains the shared folders that you want to access.

If your storage system uses both available ports to connect to the network, you can double-click either name.

The storage system name expands to display all the available shared folders.

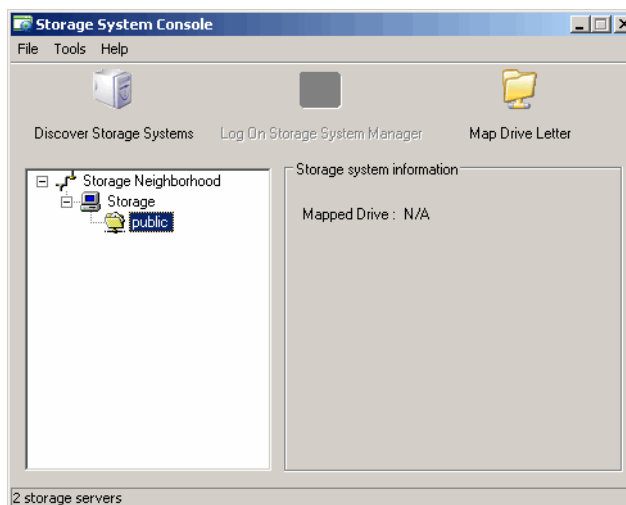

**Notes:**

- All shared folders appear in the left pane. However, you can access only the ones that you are authorized to use.
  - If your storage system uses Active Directory authentication mode, only the **public** folder appears in the left pane.
4. In the left pane, select the name of the shared folder that you want to access and then click **Map Drive Letter**.

The **Map Network Drive** dialog box appears with the name of the folder installed:

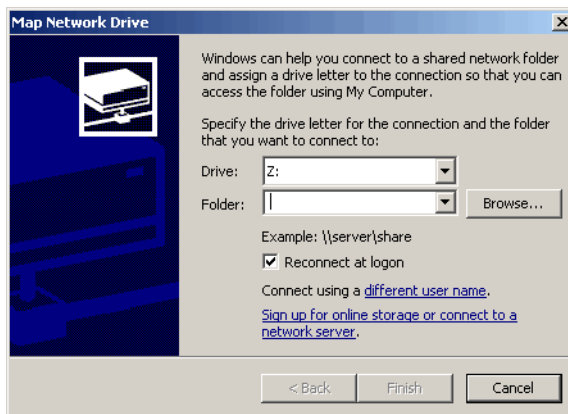

The appearance of this dialog box varies by operating system.

5. In the **Drive** list, select the drive letter that you want to assign to the shared folder.
6. To automatically connect to this shared folder each time you log on to Windows, select **Reconnect at logon**.

If you clear this option, you must repeat this procedure each time you want to access the shared folder.

7. Click **Finish**.
8. If prompted, enter your user name and password for accessing this shared folder, and then click **OK**.

**Note:** *If the user name and password for accessing the shared folder are the same as your Windows user name and password, you are not prompted to provide a user name and password to access the shared folder.*

*In addition, once you provide your user name and password for accessing one shared folder, you are not prompted to provide it again when you access other shared folders to which you have access rights.*

If the **guest** user has access to this shared folder, you can use **guest** as both the user name and password.

You can now access the shared folder from My Computer/Windows Explorer.

## Linux\* Users

To access a shared folder on a computer running Linux:

1. Create a directory by entering the following command at the command prompt:

```
mkdir /my_directory
```

where *my\_directory* is the name of the directory. Include the full path to the directory, such as, */mnt/my\_directory*.

2. If desired, display a list of all the available shared folders by entering the following command:

```
showmount -e storage_system
```

where *storage\_system* is the IP address of the storage system.

3. Mount the desired shared folder by entering the following command:

```
mount storage_system:/nas/NASDisk-00002/folder /mnt/my_directory
```

where *storage\_system* is the IP address of the storage system, *folder* is the name of the shared folder, and *my\_directory* is the name of the directory that you created in step 1.

If you included a full path when creating the directory, be sure to include the full path with this command, for example:

```
mount storage_system:/nas/NASDisk-00002/folder /mnt/my_directory
```

4. Repeat steps 1 through 3 for each shared folder that you want to access.

## Mac Users

The procedure for accessing a shared folder on a Mac varies, depending on whether the Mac is running OS X or an older operating system. Macs running OS X can access the same shared CIFS folders as Windows users. Macs running older operating systems can access the same shared NFS folders as Linux users.

### Mac OS X

To access a shared folder on a Mac running OS X:

1. From the **Go** menu, click **Connect to Server**.
2. In the **Address** text box, enter the following and click **Connect**:

```
smb://storage_system
```

where *storage\_system* is either the name or IP address of the storage system

**Note:** *You can use the storage system name only if your computer is in the same subnet as the storage system, if you added the storage system's IP address and name to your local **hosts** file, or if you manually registered the name with a DNS server in your network.*

3. In the **Select a share** list, select the name of the shared folder that you want to access and then click **OK**.

4. Enter the user name and password for accessing this shared folder, and then click **OK**.  
If the **guest** user has access to this shared folder, you can use **guest** as both the user name and password.  
An icon with the name of the shared folder is created on the desktop.
5. Repeat steps 1 through 4 for each shared folder that you want to access.
6. To access the shared folder, double-click the icon on the desktop.

## Other Mac Operating Systems

See your Mac documentation for information about accessing a shared folder using NFS on a Mac running an operating system older than OS X.

## Accessing Shared Folders using FTP

If you enabled the storage system to act as an FTP server as described in “[Changing the Network Settings](#)” on page 68, all Windows and Mac OS X users can use a Web browser to access the **public** folder.

***Note:** Even if you changed the access rights to the **public** folder. For example, to prevent a particular user from accessing it altogether or to limit a user to read-only access, all existing users have full read/write access to the **public** folder when accessing it via FTP.*

To access shared folders using FTP:

1. At any Windows or Mac OS X computer, open a Web browser, enter the following in the address bar, and press Enter:

```
ftp://user_name@storage_system
```

where *user\_name* is the user name defined on the storage system and *storage\_system* is the name or IP address of the storage system. For example, ftp://user1@storage or ftp://user1@192.168.0.101.

***Note:** You can use the storage system name only if your computer is in the same subnet as the storage system, if you added the storage system’s IP address and name to your local **hosts** file, or if you manually registered the name with a DNS server in your network.*

2. If prompted, enter your user name and password for accessing shared folders, and then click **OK**. If you use the **guest** user name, the password is also **guest**.
3. Double-click any of the displayed folders or files to open them. You have full read / write access to all the folders and files in the **public** folder and you can create new folders.

Even if you browse to other websites, you remain logged in until you close the browser window. Until you close the browser window, you can return to the FTP site using the **Back** button in your browser window.

***Note:** Files copied to or from the system using FTP can be no larger than 2 GB.*

## Disconnecting from Shared Folders

If you need to reconfigure the disks in your storage system or shut it down for any reason, all users should disconnect from the shared folders to ensure that the process proceeds smoothly. You might also want to have users disconnect from the shared folders if you want to change their access rights, since otherwise the change does not take effect until the user shuts down the computer.

The procedure for disconnecting from a shared folder varies, depending on the operating system used by the user. Users who connected to shared folders using FTP can disconnect simply by closing the browser window.

### Microsoft Windows\* Users

Windows users can disconnect from a shared folder using either My Computer/Windows Explorer or the Console.

#### Disconnecting Using My Computer/Windows Explorer

To disconnect from a shared folder using My Computer/Windows Explorer:

1. Close any files that you currently have open in the shared folder.
2. In My Computer/Windows Explorer, right-click the drive for the shared folder and then click **Disconnect** from the pop-up menu.

The shared folder no longer appears in My Computer/Windows Explorer.

#### Disconnecting Using the Console

To disconnect from a shared folder using the Console:

1. Close any files that you currently have open in the shared folder.
2. Start the Console as described in [“Starting the Console” on page 18](#).
3. In the left pane, double-click the name of the storage system that contains the shared folder from which you want to disconnect. If your storage system uses both available ports to connect to the network, you can double-click either name. The storage system name expands to display all the available shared folders.
4. In the left pane, select the name of the shared folder from which you want to disconnect, and then click **Unmap Drive Letter**. The shared folder no longer appears in My Computer/Windows Explorer.

## Linux\* Users

To disconnect from a shared folder using Linux:

1. Unmount the desired shared folder by entering:

```
umount /my_directory
```

where *my\_directory* is the name of the local directory.

For example, if you mounted the shared folder with this command:

```
mount 192.168.0.101:/nas/NASDisk-00002/public /my_directory
```

Unmount it with this command:

```
umount /my_directory
```

If you included a longer path when mounting the shared folder such as `/mnt/my_directory`, use the same path when unmounting it.

## Mac\* Users

The procedure for disconnecting from a shared folder on a Mac varies, depending on whether the Mac is running OS X or an older operating system.

### Mac OS X

To disconnect from a shared folder on a Mac running OS X:

1. On the desktop, select the shared folder from which you want to disconnect.
2. From the **File** menu, click **Eject**.

Any open window to the shared folder closes, and the shared folder disappears from the desktop.

### Other Mac Operating Systems

For information about disconnecting from a shared folder on a Mac running an operating system older than OS X, see your Mac documentation.

*Working with Shared Folders*



## 5 Protecting Local Disks

---

Even if most of your data is stored and protected on your storage system, your operating system files, applications, and many other files still reside on each individual computer in your network. If one of those local disks fails, it can take many hours to re-install and reconfigure the operating system and applications on a new or repaired hard disk, and some files might be completely lost.

Intel® Client Backup and Recovery is a software application designed to address this issue. On each computer where it is installed, Intel® Client Backup and Recovery provides reliable data protection and rapid data recovery in the event of a system crash or disk failure.

Intel® Client Backup and Recovery protects Windows desktops and laptops by backing up their local disks or partitions to the storage system. To make sure that you have recent copies of your local disk, Intel® Client Backup and Recovery can automatically perform a backup at regularly scheduled intervals—either once a day or once a week, whichever you prefer.

Alternatively, you can disable automatic backups and just perform backups manually at a time of your choosing. Once the maximum number of supported backups are saved on the storage system, the oldest backup is automatically deleted each time a new backup is performed.

The maximum number of users that you can backup is 16. The maximum number of total backups for all users is 64. If you are backing up a large number of users, you should schedule the backups at separate times in order to minimize the impact on performance.

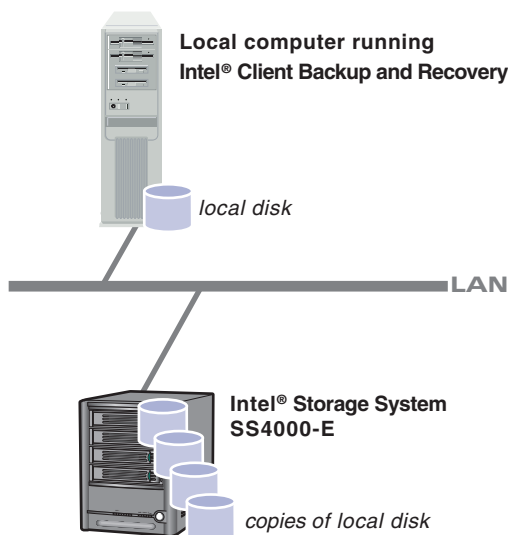

To ensure that valuable storage space isn't used up by duplicate data, when Intel® Client Backup and Recovery performs each subsequent backup, it copies only the data that has changed since the last time a backup was performed. This also minimized the impact on your network. Yet through unique technology on the storage system, each backup is a complete point-in-time image. You can view or recover the entire disk or partition exactly as it existed at a particular date and time.

If you need to recover data from the storage system, you can do so quickly and easily. You can recover just a few files or an entire disk.

- To recover a few files or folders, access the backup and copy the needed data to the local disk.
- To recover an entire data disk or partition that does not contain operating system files, use Client Backup and Recovery.
- To recover the whole system disk, use the recovery CD. If your computer does not support the recovery CD, but does support the PXE protocol, boot from a backup on the storage system and then recover the system disk. When you recover a disk, it contains the data it contained when the backup was performed. It is not necessary to reinstall or reconfigure the operating system or applications.

## Getting Started

### System Requirements

Each computer where Intel® Client Backup and Recovery is installed must have the following:

- One of the following operating systems:
  - Microsoft Windows XP\* Home Edition or Professional with Service Pack 2
  - Microsoft Windows Server 2003\* with Service Pack 1
  - Microsoft Windows 2000\* Professional, Server, or Advanced Server with Service Pack 4
- An enabled network interface card.
- A CD-ROM drive for installation and using the recovery CD. A CD-ROM drive is not required for installation if an image of the CD is accessible via a network server.
- Microsoft iSCSI Initiator\*2.x. For information about downloading and installing this item, see the next section, "[Installing the Microsoft iSCSI Initiator\\*](#)."
- 20 MB free hard disk space. Intel® Client Backup and Recovery requires the Intelligent Management Agent (IMA), which is installed automatically if it is not already installed. IMA requires an additional 5 MB of free hard disk space for the application and associated log file data.
- Microsoft .NET\* Framework 1.1 is required and installed automatically if it is not already installed. The .NET Framework requires approximately 40 MB of hard disk space.

## Additional Requirements

In addition to the system requirements, the following criteria must be met:

- You must be logged on as an administrator to install Intel® Client Backup and Recovery and run it for the first time. However, after you have run the application once as an administrator, you can subsequently run it when logged on as a user.
- If your computer name includes any characters other than letters (A-Z or a-z), numbers (0-9), hyphens (-), colons (:), or periods (.), you must change the computer name before you use Intel® Client Backup and Recovery to protect a disk.

***Note:** Previous releases allowed the use of underscores (\_) in the computer name. If your computer name included this character and you protected a disk, you must remove protection from all disks as described in “Removing Protection” on page 126, delete the client from the storage system as described in “Deleting a Client” on page 61, and protect the disks again as described in “Protecting Your Disks” on page 98. When you protect your disks again, you must remove the storage system from the list of backup locations and add it again as described in step 4 in “Protecting Your Disks” on page 98.*

- If you are using a firewall on the computer that you plan to protect, open TCP port 11762 on the firewall. This ensures that Intel® Client Backup and Recovery can communicate with the storage system. Make sure that your firewall does not block incoming network communication to the Microsoft iSCSI Initiator\*.

## Installing the Microsoft iSCSI Initiator\*

Before you can install Intel® Client Backup and Recovery, you must download and install the Microsoft iSCSI Initiator\* 2.x.

To download and install this initiator:

1. Open a Web browser, enter the following in the address bar, and press Enter:  
<http://www.microsoft.com/downloads/details.aspx?FamilyID=12cb3c1a-15d6-4585-b385-befd1319f825&DisplayLang=en>
2. Scroll down to the **Files in This Download** section and download the item that ends in **x86fre.exe**.
3. Select the option to run the file. **Run, Open, or Run this program from its current location**.
4. If a security warning displays, click **Run**. The installation wizard starts.
5. On the first page of the installation wizard, click **Next**.
6. On the page with installation options, click **Next**. **Initiator Service** and **Software Initiator** are selected by default.
7. If a message box displays telling you to configure the settings in the Control Panel, click **OK**.

***Note:** You do not have to configure the Microsoft iSCSI Initiator. Intel® Client Backup and Recovery configures it for you automatically.*

8. If you agree to the terms of the license agreement, select **I Agree** and then click **Next**.
9. When the installation completes, click **Finish**. After your computer restarts, you can install Intel<sup>®</sup> Client Backup and Recovery.

## Installing Intel<sup>®</sup> Client Backup and Recovery

You must install Intel<sup>®</sup> Client Backup and Recovery on each computer whose local disks you want to protect. A single license for the storage system is located on the back of the storage system. Additional licenses can be purchased from <http://www.intel.com/design/servers/storage/offers>.

To install Intel<sup>®</sup> Client Backup and Recovery using Internet Explorer:

1. Log on as an administrator and insert the installation CD into a CD-ROM drive.
2. Select Software from the top menu.

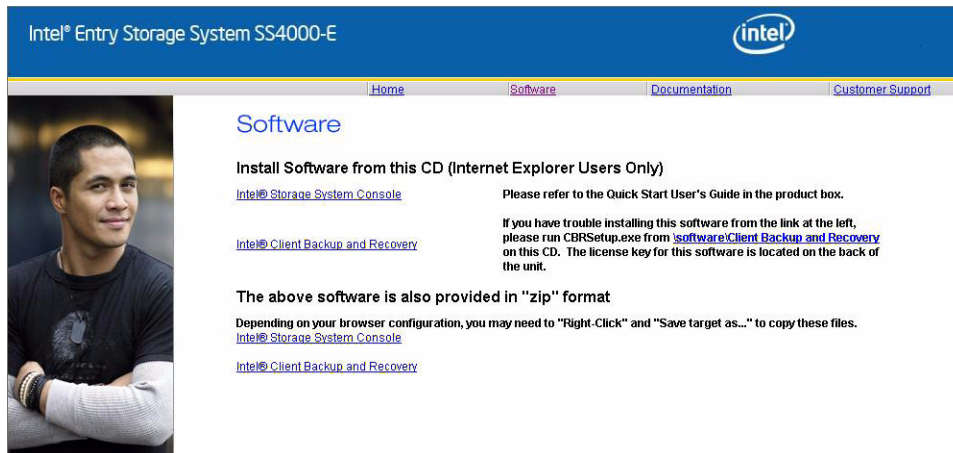

3. Select the “Intel<sup>®</sup> Client Backup and Recovery” link to install the software.

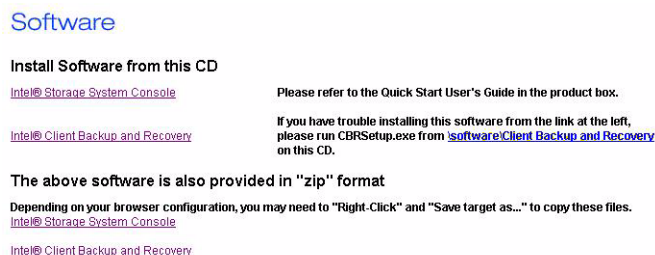

4. Start the setup utility for Intel<sup>®</sup> Client Backup and Recovery.

5. If Microsoft\* iSCSI Initiator 2.0 is already installed, go to the next step. If this component is not currently installed, the following prompt displays:

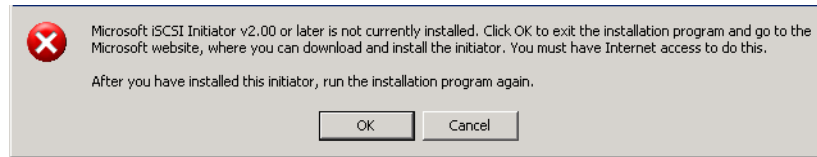

Click **OK** to go to the Microsoft website and then click **OK** to cancel the installation of Intel® Client Backup and Recovery.

On the Microsoft website, click **iSCSI Software Initiator v2.0**, and follow the instructions in “[Installing the Microsoft iSCSI Initiator\\*](#)” on page 91.

You must install the Microsoft iSCSI Initiator 2.0 before you can install Intel® Client Backup and Recovery.

When you have finished installing the iSCSI initiator, re-start the installation of Intel® Client Backup and Recovery.

6. If Microsoft .NET Framework 1.1 is already installed, go to step 9. If this component is not currently installed, the following prompt displays:

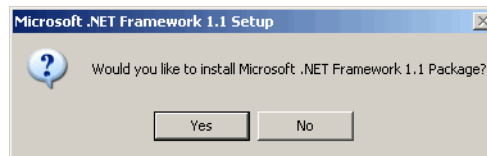

Click **Yes** to install this component. You cannot install Intel® Client Backup and Recovery without first installing Microsoft .NET Framework 1.1.

When you click **Yes**, the setup utility for Microsoft .NET Framework 1.1 starts:

7. If you agree to the terms of the license agreement, select **I agree** and then click **Install**.

It might take some time to copy and configure the associated files.

***Note:** The remaining time might be reported as 0 and it might display that no progress is occurring. However, configuration is occurring in the background.*

8. When a message displays, indicating that the installation of Microsoft .NET Framework 1.1 is complete, click **OK**.

After you click **OK**, the Intelligent Management Agent is installed automatically if it is not already installed, and the welcome page for installing Intel® Client Backup and Recovery displays.

9. On the welcome page, click **Next**. The license agreement displays.
10. If you agree to the terms of the license agreement, select **I accept the terms of the license agreement** and then click **Next**.

11. Click **Next** to install the Intel® Client Backup and Recovery in the displayed location or click **Browse** to select different location, click **OK**, and then click **Next**.

**Note:** Intel® Client Backup and Recovery must be installed on the system partition from which you boot. This is where Windows is installed, typically C:. If the application is not installed on the system partition, you cannot use PCE Remote boot.

If you install Intel® Client Backup and Recovery on a non-system partition of your system disk, you cannot recover that partition using the Client Backup and Recovery application window.

If you install Intel® Client Backup and Recovery on a different disk than your system disk, you cannot boot remotely.

12. To complete the installation and restart your computer, click **Finish**.

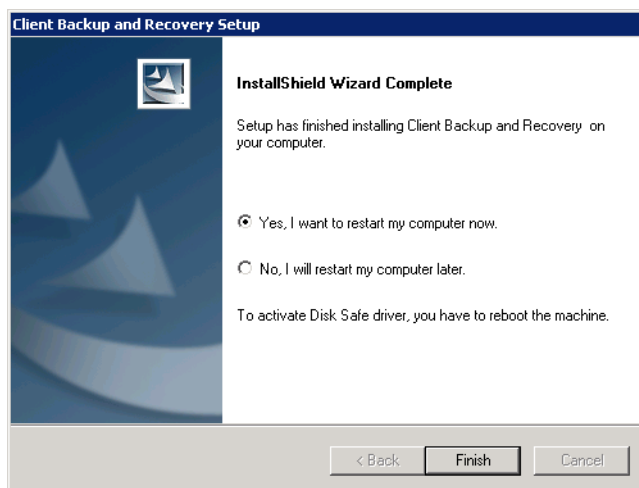

If you do not want to restart your computer at this time, select **No, I will restart my computer later** and then click **Finish**. When the confirmation message displays, click **OK**. You do not have to restart the computer immediately after installation, but you do have to restart it before running Intel® Client Backup and Recovery.

**Note:** If you do not restart your computer and you subsequently reinstall Intel® Client Backup and Recovery, serious problems can occur with your installation. It is strongly recommended that you restart your computer at your earliest convenience.

13. After you restart your computer, click **OK** on the welcome message. The **Add License** dialog box appears.

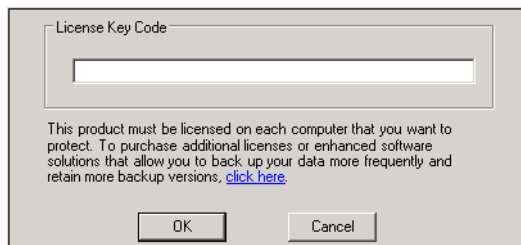

14. Enter the key code for licensing the product and click **OK**. The license key code is located on the back of the storage system.

If you have an Internet connection, the license is activated automatically. When you click **OK** on the confirmation message, the Protect a Disk wizard starts. For information about this wizard, see “[Protecting Your Disks](#)” on page 98.

***Note:** If you previously used this key code on a different computer, an error message displays, and you must re-activate your license. For more information, see “[Activating Your License](#)” on page 96.*

If your Internet connection is temporarily down, or if this computer doesn’t have an Internet connection, click **OK** on the warning message. The Protect a Disk wizard still starts, but after 30 days you no longer can perform backups or recovery until you activate the license. For more information, see “[Activating Your License](#)” on page 96.

## Starting Intel® Client Backup and Recovery

To start Intel® Client Backup and Recovery, do either of the following

- Click **Start > Programs > Client Backup and Recovery**
- If the Intel® Client Backup and Recovery Agent is running as indicated by the presence of the Agent icon (📁💻) in the system tray, double-click this icon.

If you did not protect a disk after installing Intel® Client Backup and Recovery and restarting your computer, you are prompted to do so the first time you run this application. For information about this wizard, see “[Protecting Your Disks](#)” on page 98.

If you already protected a disk, the application window displays:

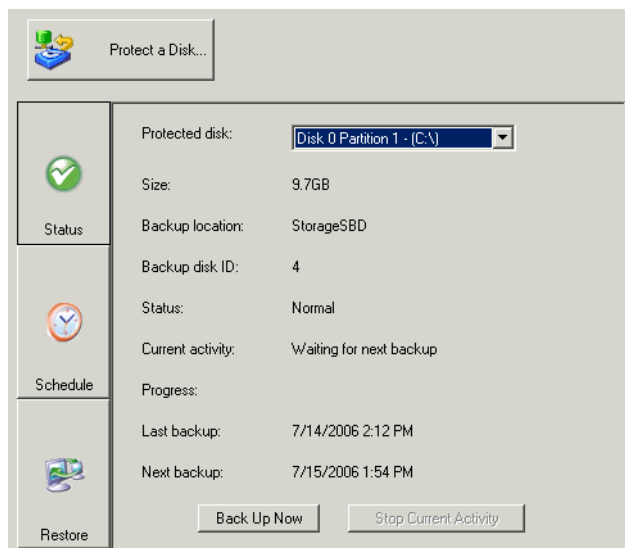

The **Status** page displays the name of the disk that you protected and related information, such as the size of the disk, the name of the storage system where the backup resides (**Backup location**), the number used to identify the backup disk on the storage system (**Backup disk ID**), the current backup status, a progress bar that displays information about any ongoing activity, the date and time of the last backup and next scheduled backup, if any, and the number of backups to keep.

**Note:** *If your license is not currently activated, a message displays, advising you of this. You must activate your license within 30 days of installing Intel® Client Backup and Recovery. After that time, you no longer can perform backups or recovery. For more information, see “[Activating Your License](#)”.*

## Activating Your License

When you install Intel® Client Backup and Recovery and restart your computer, you are prompted to license the product. If your computer has an Internet connection, the license is activated automatically. However, if your Internet connection was temporarily down or if your computer has no Internet connection, your license was not activated. You must activate your license within 30 days of installing Intel® Client Backup and Recovery; otherwise, you are not be able to perform backups or recovery.

If your Internet connection was down, your license is activated the next time you run Intel® Client Backup and Recovery with a restored Internet connection. If your computer has no Internet connection, you must perform offline activation as described in the next section.



If your computer had no network interface card (NIC) when you installed Client Backup and Recovery, or your NIC was disabled, and you subsequently add or enable a NIC, you must add the license again, as described in “[Replacing Your Existing License](#)” on page 98, to activate it.

**Note:** *Activation is tied to your computer’s hardware. Once you have activated a license, if your computer hardware changes, or if you subsequently install Intel® Client Backup and Recovery on a different computer using the same key code, an error message displays. Contact Intel Customer Support for help.*

## Activating Your License Without an Internet Connection

If your license wasn’t activated because your computer has no Internet connection, you must obtain an activation code using another computer that does have both an Internet connection and e-mail.

To activate your license without an Internet connection:

1. From the **Action** menu, click **License > Offline Activation**. The **Offline Activation** dialog box appears.
2. Click **Export License Data**.
3. On the **Save As** dialog box, select one of the following locations and then click **Save**:
  - A shared folder accessible to both your computer and a computer that has Internet and e-mail access
  - A floppy disk
  - A USB disk
4. If you did not save the file to a shared folder, take the floppy disk or USB disk to a computer with Internet and e-mail access.
5. From the computer that has Internet and e-mail access, e-mail the license file to the following address:
 

```
Activate.Keycode@falconstor.com
```
6. When you receive an e-mail response, save the returned license file back to the shared folder, floppy disk, or USB disk.
7. If you did not save the file to a shared folder, take the floppy disk or USB disk back to the computer where Client Backup and Recovery is installed.
8. From the **Action** menu, click **License > Offline Activation**.
9. Click **Import Activation Code**.
10. On the **Open** dialog box, browse to the location where the returned license file exists and double-click it.
11. On the confirmation message, click **OK**. The license is now activated and you can continue to back up and recover your disks.
12. To close the dialog box, click **Exit**.

## Replacing Your Existing License

To replace your existing license:

1. From the **Action** menu, click **License > Add License**. The **Add License** dialog box displays your current license key code.
2. In the **License key code** text box, enter the new key code.
3. Click **OK**.
4. When the confirmation message displays, click **OK**. If your computer has an Internet connection, the license is activated automatically. If your Internet connection is temporarily down, your license will be activated automatically the next time you run Intel® Client Backup and Recovery with a restored Internet connection. If this computer does not have an Internet connection, you must perform an offline activation as described in the previous section.

## Protecting Your Disks

After you install Intel® Client Backup and Recovery and restart your computer, the Protect a Disk wizard runs automatically. Using this wizard, you can specify which disk or partition you want to back up, where the backups should be stored, when automatic backups, if any, should occur, and what password you want to use for the recovery CD or booting remotely. If you cancel this wizard, you can start it again at any time using the following procedure.

Before you protect a disk, it is recommended that you confirm that sufficient space is available on the storage system. At least an additional 20% of the disk size is required for changed data. For example, if the disk that you want to protect is 15 GB, at least 18 GB of space must be available on the storage system. The **Home** page in the Manager, described in [“Navigating the Manager” on page 28](#), displays the amount of available space.

To protect a disk:

1. Click **Protect a Disk**. The Protect a Disk wizard runs.
2. In the **Available disks** list, select the disk or partition that you want to protect.

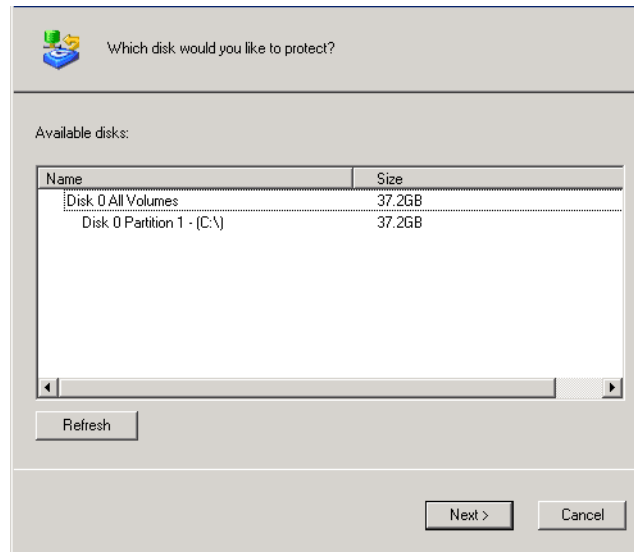

Even if your computer has only one hard disk, two items display in this list. The first item represents the entire hard disk, and the second item represents the partition on that disk. If there's only one partition on the disk, the partition is the same as the entire disk.

If your hard disk is divided into multiple partitions, this list displays one item for the entire hard disk, and one item for each partition. If your computer has multiple hard disks, this list displays an item for each entire disk and an item for each partition on each disk. Each partition is identified by its drive letter.

**Note:** *Dynamic disks are not supported.*

If you select an entire disk, all the partitions on that disk are protected as a single entity. This means that you can't later recover only one partition; you have to recover the entire disk. If you select just a partition, you can subsequently recover just that partition.

In addition, you can recover a data disk or partition using Intel® Client Backup and Recovery, but you can recover a system disk or partition only using the recovery CD or when booting remotely from a backup on the storage system. Therefore, if you have separate partitions for your system information and your data, you might want to protect each one separately.

**Recommendations:**

- If your computer has only one disk with one partition, select the disk.
  - If any partition, such as an EISA partition, precedes your system partition, select the entire disk. This ensures that you can remotely boot from and recover the disk.
  - If your disk has a system partition and a data partition, select one of the partitions and complete the wizard. Then run the wizard again and protect the other partition. This provides complete protection with maximum flexibility.
- However, Intel Client Backup and Recovery should be installed on the system partition so that you can remotely boot later.

**What To Do Next:**

In this case	Go to this step
You have not completed the Protect a Disk wizard	3
You completed the Protect a Disk wizard and connected to a storage system	4
You protected this disk and removed protection, or an allocation error occurred the first time you tried to protect the disk	5

3. When the **Add Storage System** dialog box displays, Client Backup and Recovery automatically scans your subnet for storage systems. Any storage systems that are detected display in the **Discovered storage systems** list.

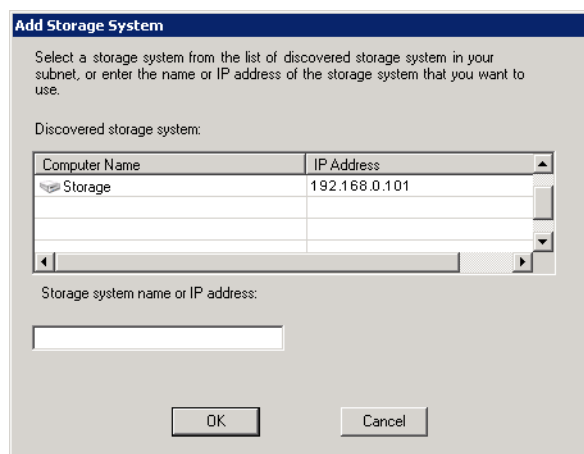

From the **Discovered storage systems** list, select the storage system where you want to back up the selected disk. The name of the storage system displays in the **Storage system name or IP address** text box.

If you plan to remotely boot from a backup on the storage system, it is recommended that you select the IP address of the first port. If the DHCP server option is enabled on your storage system, you can remotely boot only from the first port. If this option is disabled and you are using a separate DHCP server, you can remotely boot from either port.

If no storage systems are automatically discovered, or if you want to back up your disk to a different storage system, enter the name or IP address of the desired storage system in the **Storage system name or IP address** text box.

Click **OK**.

***Note:** If an authentication error occurs, make sure the name or IP address of the storage system is correct, and that your computer is connected to the network.*

- From the **Backup locations** list, select the storage system to use for backups of this disk or partition. The first backup location in the list is selected by default.

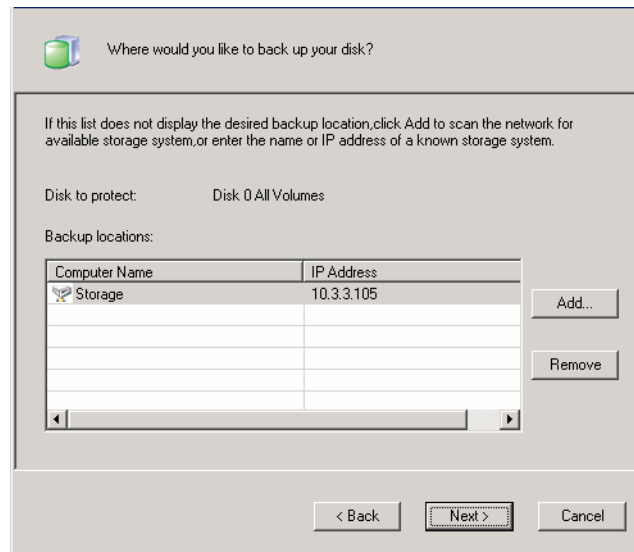

If you want to scan the network for new storage systems, or add a new one manually, click **Add** and repeat step 3.

If you want to remove a storage system that is not valid or that you no longer want to use, select the storage system from the **Backup locations** list, click **Remove**, and then click **Yes** to confirm the removal. You can remove a storage system only if it is not being used to protect another disk.

Once you have selected the desired backup location, click **Next** and go to step 6.

5. If you previously protected this disk and removed protection, specify whether or not you want to re-use the existing backup or create a new one:

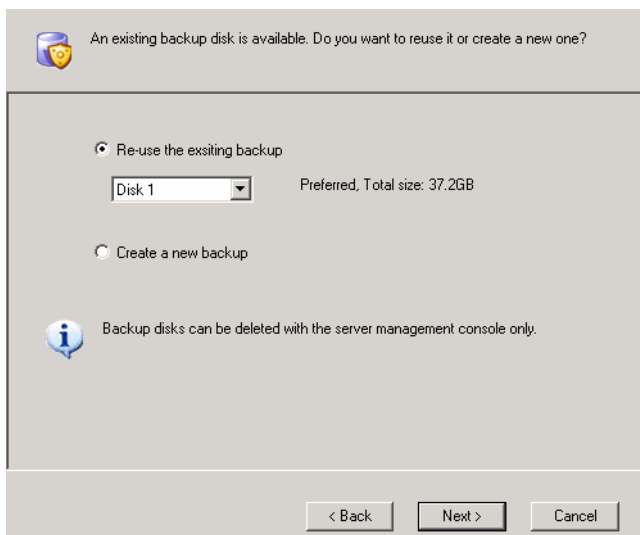

If you select **Re-use the existing backup**, you must select which backup to re-use from the list. When you select an item from the list, the size also displays to help you identify exactly which backup to use. The word **Preferred** displays for the backup that best matches the disk that you are currently protecting. Once you have selected the desired backup, click **Next** and go to the next step.

**Note:** *If the list does not display the expected information, you might need to click **Cancel**, click **Action** > **Repair Connection**, and then try to protect the disk again. Repairing the network connection refreshes the information about the backups that exist on the storage system.*

**Caution:** *If you select any disk other than the preferred one, all the data associated with the selected disk is overwritten with the data associated with the disk that you are protecting, and you are not able to recover any previous backups associated with the selected disk.*

If you select **Create a new backup** and click **Next**, you must select the desired backup location as described in step 4.

## 6. Specify when you want backups to occur.

When do you want backups to occur?

Disk to protect: Disk 0 All Volumes

Backup location: Storage

Backup schedule

Recurrence: Time:

Daily 04:43 PM

Back up now

< Back Next > Cancel

For example, if you want backups to occur every day, select **Daily** from the **Recurrence** list. If you want backups to occur once a week, select the day of the week from the **Recurrence** list. Then select the time.

If you do not want backups to occur automatically, select **Not Scheduled** from the **Recurrence** list. Backups occur only when you start one manually as described in [“Manually Backing up Your Disk” on page 105](#).

**Notes:**

- *If you are using Client Backup and Recovery, only four backups of each protected disk or partition are saved on the storage system, so if you back up your disk every day, you'll be able to recover data from only the last four days. If you back up your disk once a week, you'll be able to recover data from four weeks ago, but the most recent backup might be as many as six days old.*
- *Although Intel® Client Backup and Recovery is specifically designed to perform backups without affecting your other computer activities, you might want to schedule backups for a time when they'll have the least impact on your system, like during lunch or after business hours if you leave your computer running overnight. If you are protecting multiple disks or partitions, it is recommended that you schedule each backup to occur at a different time.*

7. Specify whether or not to back up your disk as soon as you finish the wizard by selecting or clearing the **Back up now** check box, and then click **Next**.

If you clear this option, the disk is backed up at the next scheduled time or the next time you perform a manual backup.

**Note:** *Be sure to back up your disk or partition before you try to recover it using the recovery CD as described in [“Recovering a System Disk Using the Recovery CD” on page 117](#).*

8. If you ever need to recover your disk using the recovery CD or remotely boot from a backup on the storage system, you'll be prompted for a password. In the **Recovery password** text box, enter the password that you'd like to use, enter it again in the **Retype your password** text box, and then click **Next**.

The screenshot shows a dialog box titled "What password would you like to use for recovering data using the recovery CD or for booting remotely from the storage system?". It contains a CD icon and a question mark. Below the title, there is a paragraph of text: "This password must be 12-16 characters long. The same password is used for all the disks that you protect at the same backup location. If the remote boot option is enabled, this password is also used to authenticate on the storage system during a remote boot." Below this text, there are three input fields: "User name:" with the value "client", "Recovery password:" with an empty text box, and "Retype your password:" with an empty text box. At the bottom of the dialog, there are three buttons: "< Back", "Next >", and "Cancel".

**Notes:**

- The recovery password must be 12–16 characters long.
  - The same password is used for all disks backed up to the same storage system. If you subsequently protect a second disk using the same storage system, you are not prompted to provide this password again. However, if you protect a second disk using a different storage system, you are prompted to provide a password for that storage system.
  - You can change this password later using Intel<sup>®</sup> Client Backup and Recovery, as described in [“Changing the Recovery Password” on page 108](#), and using the storage system as described in [“Changing the Recovery Password” on page 59](#).
9. Review your selections and click **Finish**.

If you selected the **Back up now** check box, the backup begins as soon as you click **Finish**, and you can review its progress on the **Status** page in Client Backup and Recovery.

If you want to protect additional disks or partitions, repeat this procedure for each one.

**Note:** If you subsequently change the drive letter of a protected disk or partition, you must restart Intel<sup>®</sup> Client Backup and Recovery to update this application.



## Manually Backing up Your Disk

Once you protect a disk, it is automatically backed up at regular intervals unless you chose **Not Scheduled** from the **Recurrence** list when you completed the schedule. You can also back up a disk manually as long as a backup or recovery is not currently occurring. For example, if you are about to install a new application, you might want to back up your disk right before you start the installation, so if any problems occur, you can recover your disk to the state it was in immediately before you installed the application.

To manually back up a disk:

1. Click **Status**.

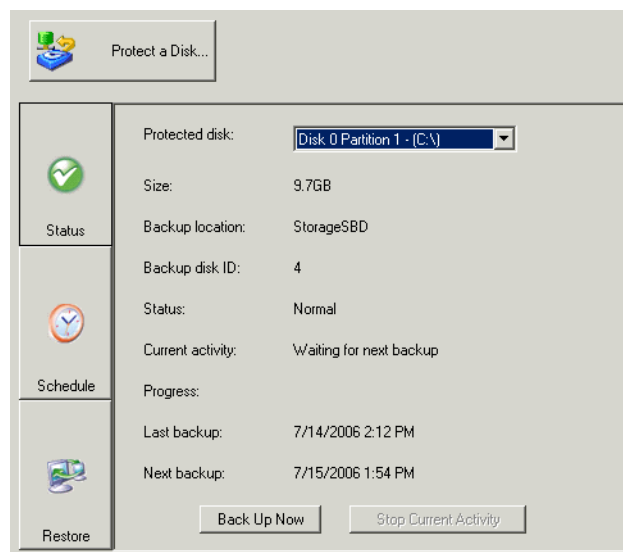

2. In the **Protected disk** list, select the disk that you want to back up.
3. Click **Back Up Now**. The **Current activity** area displays information about what's happening, the percentage of the backup that has completed, and the speed at which the data is being sent over the network. The **Progress** bar graphically indicates how much of the backup is complete.

To stop a backup in progress, click **Stop Current Activity**.

## Stopping a Backup or Recovery in Progress

Once a backup or recovery starts, you can stop it at any time. For example, you may decide to stop it if you notice that your system is not responding as quickly as you'd like, and you want to free processing capabilities for other tasks.

When you stop a backup in progress, that backup does not display in the list of backups on the **Restore** page, and any changed data that was not copied to the storage system is copied during the next backup.

When you stop a recovery in progress, the local disk or partition is left in an incomplete state, and you must recover it again later before you can use it.

To stop a backup or recovery in progress:

1. Click **Status**.

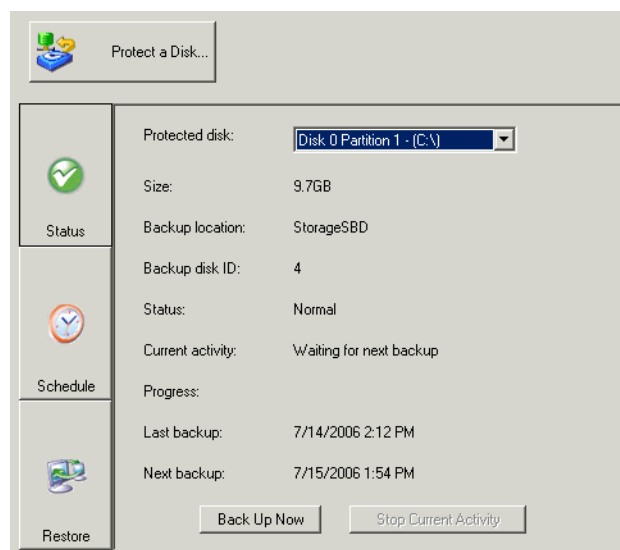

2. In the **Protected disk** list, select the disk whose backup or recovery you want to stop.
3. Click **Stop Current Activity**. If you are stopping a backup, the backup stops immediately.

If you are stopping a recovery, a confirmation message displays. Click **OK** to stop the recovery now, or click **Cancel** to proceed.

## Changing the Backup Schedule

When you protect a disk, you specify when you want backups to occur. However, you can change this schedule at any time as long as the **Status** page indicates that the **Status** is **Normal**. If protection is stopped, such as if you recovered the disk or recovered a different partition on the same disk, you cannot change the disk schedule until you resume protection by clicking **Back Up Now**.

To change the backup schedule:

1. Click **Schedule**.

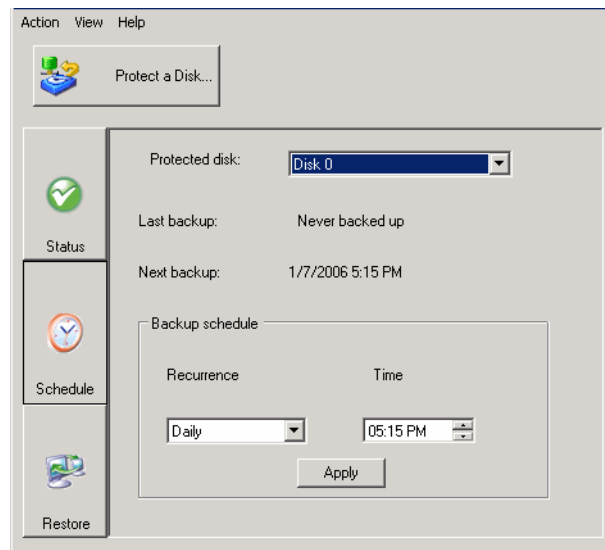

2. In the **Protected disk** list, select the disk whose backup schedule you want to change.
3. Specify when you want backups to occur.

For example, if you want backups to occur every day, select **Daily** from the **Recurrence** list. If you want backups to occur once a week, select the day of the week from the **Recurrence** list. Then select the time.

If you do not want backups to occur automatically, select **Not Scheduled** from the **Recurrence** list. Backups occur only when you start one manually as described in [“Manually Backing up Your Disk” on page 105](#).

4. Click **Apply**.
5. When the confirmation message displays, click **Yes**.
6. When the result message displays, click **OK**. The schedule change takes effect immediately, and the date and time of the next scheduled backup displays in the **Next backup** area.

## Receiving Event Notifications

When you install Intel® Client Backup and Recovery, the Client Backup and Recovery Event Viewer is also installed. This program starts automatically whenever you start your computer, and the Agent icon displays in your system tray.

When the Agent is running, a pop-up message displays whenever a backup-related problem occurs, such as if a scheduled backup did not occur because the storage system was not running.

You can close the Agent at any time. However, if you do this, notifications no longer display automatically. If you subsequently want to start the Agent again, you can do so using Intel® Client Backup and Recovery.

To close the Agent:

- In the system tray, right-click the Agent icon () and click **Exit Client Backup and Recovery Agent**.

To restart the Agent after you have closed it:

- From the **View** menu, click **Agent**. The Agent icon appears in the system tray.

## Changing the Recovery Password

When you protect a disk, you specify the password to use for recovering the disk using the recovery CD or when you remotely boot from a backup on the storage system. You can change this password at any time as long as the **Status** of the backup is **Normal**. This ensures that the change is also made on the storage system.

**Note:** *The same password is used for all disks backed up to the same storage system. If you backed up multiple disks to the same location and change the password for one, the password is changed for all of them. However, if you backed up one disk to one storage system and a different disk to a different storage system, each disk can have a different recovery password.*

To change the recovery password:

1. Click **Restore**.

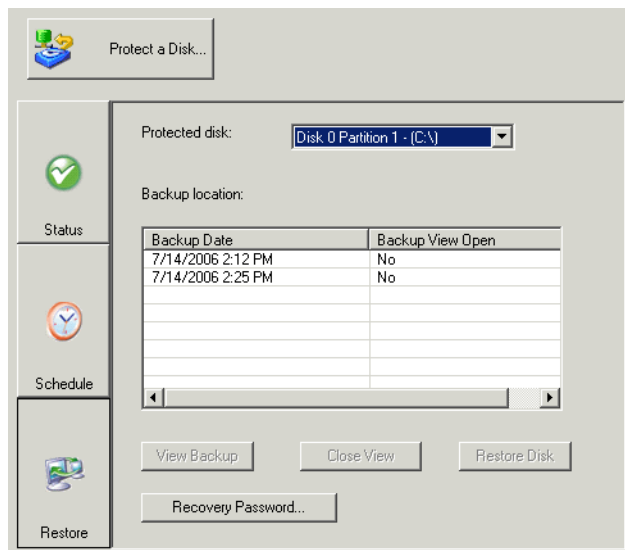

2. In the **Protected disk** list, select a disk whose backup resides on the storage system whose recovery password you want to change.

To check your selection, click **Status**. The name of the storage system displays in the **Backup location** area. Click **Restore** to return to the **Restore** page.

3. Click **Recovery Password**. The Reset Recover Password dialog box displays.

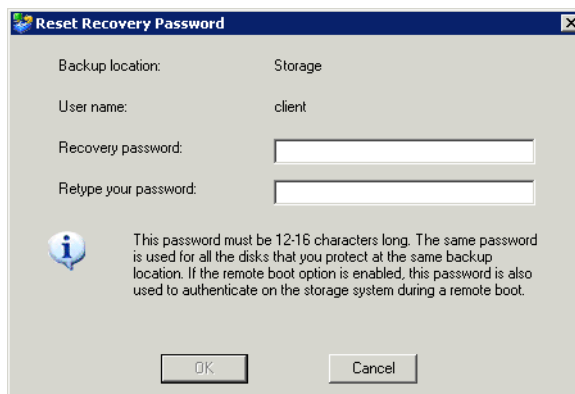

4. In the **Recovery password** text box, enter the desired password. This password must be 12–16 characters long.
5. In the **Retype your password** text box, enter the password again.
6. Click **OK**.

## Enabling or Disabling Remote Boot

If you need to recover your system disk or partition, using the recovery CD is recommended, as described in “[Recovering a System Disk Using the Recovery CD](#)” on [page 117](#). If your computer does not support the recovery CD but does support the PXE protocol, you can remotely boot your computer from a backup on the storage system and then recover your system disk. If you are not sure if your computer supports the PXE protocol, try to enable remote boot. If your computer does not support the PXE protocol, an error message displays.

**Caution:** *It is strongly recommended that you determine whether or not your computer supports the recovery CD before a system failure occurs. To do this, perform steps 1 through 3 in “[Recovering a System Disk Using the Recovery CD](#)” on [page 117](#) and use **Diagnostic Mode** to confirm that at least one network interface card is supported.*

*If your computer does not support the recovery CD, you must enable remote boot before a system failure occurs. Once your system has failed, you cannot enable remote boot.*

*If your computer does not support either the recovery CD or the PXE protocol, gather your hardware information, as described in step 4 in “[Recovering a System Disk Using the Recovery CD](#)” on [page 117](#), and send it to your vendor. You might be able to obtain an updated recovery CD or a new driver that makes your computer compatible with your existing recovery CD.*

You can enable remote boot only if the following criteria have been met:

- Microsoft Windows\* was installed on the first partition of the first disk in your computer.
- Intel® Client Backup and Recovery was installed on that system partition.
- You protected your system disk or partition.
- You are accessing the computer directly rather than using Remote Desktop.

**Note:** *You must wait until the initial backup of your system disk or partition has completed before you enable remote boot.*

When you enable remote boot, your network connection is temporarily interrupted. It is recommended that you enable remote boot when this does not adversely affect any network applications that you might be running.

If remote boot is successfully enabled, a new backup is created automatically.

Once you have enabled remote boot, if you subsequently want to boot remotely using a different network interface card (NIC), you must first disable remote boot and then enable it again, specifying the other NIC. In addition, after you recover a disk while booting remotely, you must disable and re-enable remote boot.

## Enabling Remote Boot

To enable remote boot:

1. In the **Protected disk** list on any page, select your system disk or partition. If you protected multiple system disks or partitions, select the first system disk or partition on your computer. This is typically Disk 0.
2. From the **Action** menu, click **Enable Remote Boot**. The Enable Remote Boot dialog box displays. This dialog box displays a list of all the NICs on your computer.

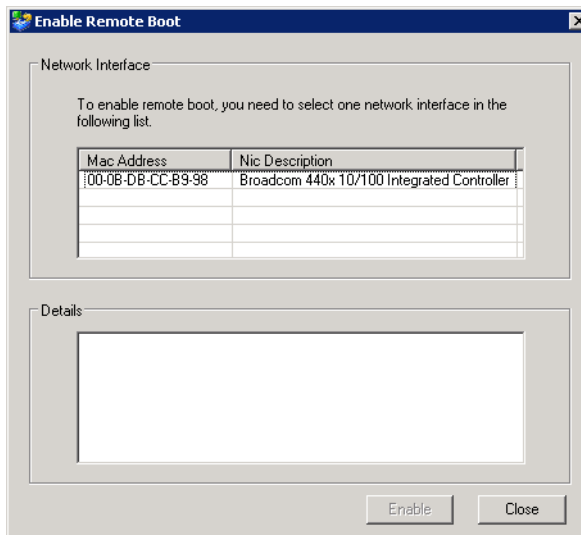

3. From the list, select the NIC that you want to use when remotely booting from the storage system. For a list of supported NICs, go to <http://www.intel.com/support/motherboards/server/ss4000-e/>.
4. Click **Enable**. A message displays, advising you that your network connection is temporarily interrupted.

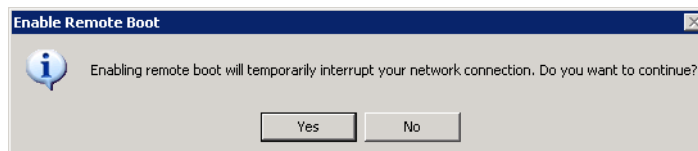

5. Click **Yes** to allow the temporary network interruption. Your network connection is restored immediately after this process is complete.

On the Enable Remote Boot dialog box, the **Details** area shows the progress of the enabling process. If any problems are encountered—for example, if the selected disk or partition was not your system disk—that portion of the process is marked as **Failed**. You can click the plus sign next to the process description to expand it and display an error message that explains exactly what happened.

6. When a message displays, advising you that drivers will be installed, click **OK**.
7. When the drivers are installed, one or more messages might display, advising you that these drivers are not signed. This has no adverse effect on your system. Click **Continue Anyway** or **Yes** on each message to proceed with the installation.

In addition, the Found New Hardware Wizard starts. Select **No, Not this Time** on the initial screen and complete the rest of the wizard, accepting all the default values.

If remote boot was successfully enabled as indicated in the **Details** area, a new backup is created.

***Note:** If remote boot was successfully enabled but for some reason the new backup was not created as indicated in the **Details** area, you must perform a manual backup as described in “[Manually Backing up Your Disk](#)” on page 105. You can remotely boot only from backups that were performed after remote boot was enabled.*

8. Click **Close**. If no problems were encountered, you can now remotely boot from the storage system as described in “[Recovering a System Disk While Booting Remotely](#)” on page 122.

If any problems were encountered, take corrective action. For example, if you did not previously protect a system disk or partition, do so now as described in “[Protecting Your Disks](#)” on page 98. Repeat this procedure for enabling remote boot until all parts of the process complete successfully.

## Disabling Remote Boot

Disabling remote boot restarts your computer automatically. It is recommended that you save and close any open files on your system before you do this.

To disable remote boot:

1. From the **Action** menu, click **Disable Remote Boot**. A progress bar displays the progress of the process.
2. When the confirmation message displays, click **OK**. Your computer restarts.

## Recovering Data

With Intel® Client Backup and Recovery, there are several ways to recover data from backups. The best method depends on your goals and the capabilities of your computer:

- **Recover selected folders, files, or sections of files**—If you accidentally permanently deleted a file or folder that you want to recover, or if you just want to retrieve some information from a file that you changed, you can access the backup that contains the desired data and copy it to your local disk.

You can use this procedure to try out different “what if” scenarios—for example, changing the format of the data in a file—without adversely affecting the data on your local disk.

For more information, see “[Recovering Files or Folders](#)” on page 114.



- **Recover an entire data disk or partition**—If you protected a disk or partition that isn't being used to run the operating system, you can recover that disk or partition using Intel<sup>®</sup> Client Backup and Recovery. You might need to do this if the disk has become corrupted or the data has been extensively damaged. The entire disk or partition is restored to its exact state at the time of the selected backup.

You can continue to use your computer for other tasks while the data is being recovered, although not any applications or files located on the disk or partition that you are recovering.

For more information, see [“Recovering a Data Disk” on page 116](#).

- **Recover an entire system disk or partition**—If you need to recover your system disk or partition—that is, the disk or partition used to run the operating system—you can do so using the recovery CD. This is particularly useful if the hard disk has failed and has been repaired or replaced, or if you want to duplicate an existing disk to another computer. The entire disk or partition is recovered to its exact state at the time of the selected backup. However, you won't be able to use your computer until all this process is complete. For more information, see [“Recovering a System Disk Using the Recovery CD” on page 117](#).

Alternatively, if your computer does not support the recovery CD but does support the PXE protocol, you can boot your computer from a backup on the storage system and then recover your system disk. For more information, see [“Recovering a System Disk While Booting Remotely” on page 122](#).

**Caution:** *It is strongly recommended that you determine whether or not your computer supports the recovery CD before a system failure occurs. To do this, perform steps 1 through 3 in [“Recovering a System Disk Using the Recovery CD” on page 117](#) and use **Diagnostic Mode** to confirm that at least one network interface card is supported.*

*If your computer does not support the recovery CD, you must enable remote boot, as described in [“Enabling Remote Boot” on page 111](#), before a system failure occurs. Once your system has failed, you cannot enable remote boot.*

*If your computer does not support either the recovery CD or the PXE protocol, gather your hardware information, as described in step 2 in [“Recovering a System Disk Using the Recovery CD” on page 117](#), and send it to your vendor. You might be able to obtain an updated recovery CD or a new driver that makes your computer compatible with your existing recovery CD.*

## Recovering Files or Folders

To recover selected folders, files, or sections of files from a backup:

1. Click **Restore**.

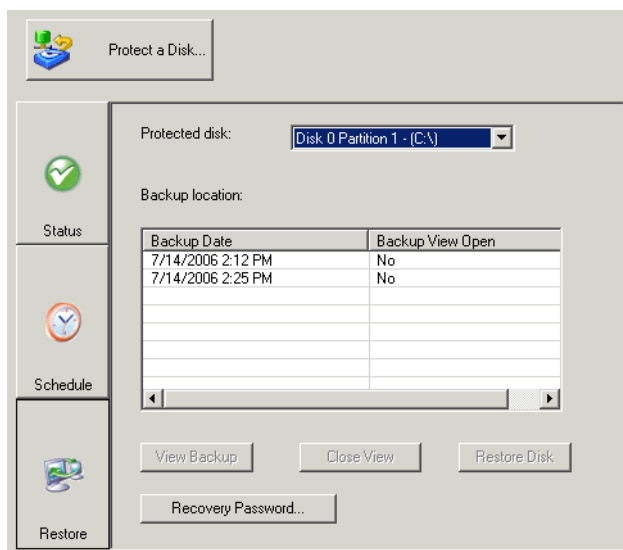

2. In the **Protected disk** list, select the disk that contains the folders or files that you want to recover.
3. In the **Backups** list, select the backup from the desired date and time. You can select only a backup for which **No** displays in the **Backup View Open** column.
4. Click **View Backup**.
5. When the confirmation message displays, click **OK**.

After a few moments, a window opens, displaying all the data associated with the selected backup. You can now open the folders and files in the backup view to make sure they contain the information you want, and copy any of the data to your local disk.

**Caution:** *You can open and change the files in the backup view, and even create new folders or files there. However, as soon as you close the view as described in the next step, all changes are lost. The next time you view the backup, it displays the way it existed when the backup was created.*

**Notes:**

— *If the first drive letter after your local disks is mapped to a shared network folder, you must use Disk Management to change the drive letter assigned to the backup view so that you can access it.*

*For example, if your system disk is mapped to C:, your CD-ROM drive is mapped to D:, and a shared network folder is mapped to E:, and you view a backup, you*

continue to see the shared network folder when you explore E:, and you do not see a new drive letter for the backup view. Internally, the backup view is also mapped to E:, since that was the first drive letter after the local disks. However, when you use Disk Management to change the drive letter for the backup view from E: to F:, you are able to see both the shared network folder (E:) and the backup view (F:).

To change the drive letter, right-click My Computer and click **Manage**. In the left pane, click **Disk Management**. In the right pane, right-click the backup view, click **Change Drive Letter and Paths**, click **Change**, select the desired drive letter from the list box, and then click **OK** on each dialog box. You can now access the backup view using the specified drive letter.

- If you open a backup view of a disk that contains multiple partitions, a drive letter is assigned to each partition.
  - Windows caching can affect the content of the backup view. If the content look correct, restart your computer and check again.
  - You can view more than one backup simultaneously. Simply repeat steps 3 and 4 for each backup that you want to view.
  - If you open a backup view for a partition that cannot be explored, such as an EISA partition, the backup view is closed automatically.
  - When a backup view is open, that backup is not deleted to make room for new backups until it is closed or unless the storage system runs critically low on resources. If you view the oldest backup, and the maximum number of backups is reached, new backups cannot occur until the view of the oldest backup is closed, as described in the next step.
  - When you close the Intel<sup>®</sup> Client Backup and Recovery application window, you are prompted to close all open backup views. If you click **Yes**, both the application window and all open views are closed. If you click **No**, both the application window and all open views remain open.
6. When you have finished viewing or copying all the desired data, select the backup in the **Backups** list and click **Close View**.

The Windows Explorer window closes automatically, and the **Backup View Open** column for the selected backup now displays **No**.

## Recovering a Data Disk

You can recover a data disk or partition only as long as Intel® Client Backup and Recovery is not installed on that disk or partition, the disk or partition is not currently being backed up, and a more recent backup view is not open.

If you recover a partition and other partitions of that same disk are also protected, protection for those other partitions temporarily stops until the selected partition is recovered.

Once the recovery of any data disk or partition is complete, your computer restarts automatically.

**Caution:** *When you recover a data disk or partition, you lose any data that was written to the disk after the time of the selected backup, as well as any backups that were performed after the backup you are recovering. You might want to copy any newer files that you want to keep to another disk before you recover the disk.*

*In rare cases, such as if your data disk contains applications like anti-virus programs that interact with the operating system, if network errors occur or the storage system shuts down during recovery, your operating system might become unstable, and you have to recover it using the recovery CD or re-install the operating system if you did not protect your system disk.*

To recover a data disk or partition:

1. Click **Restore**.

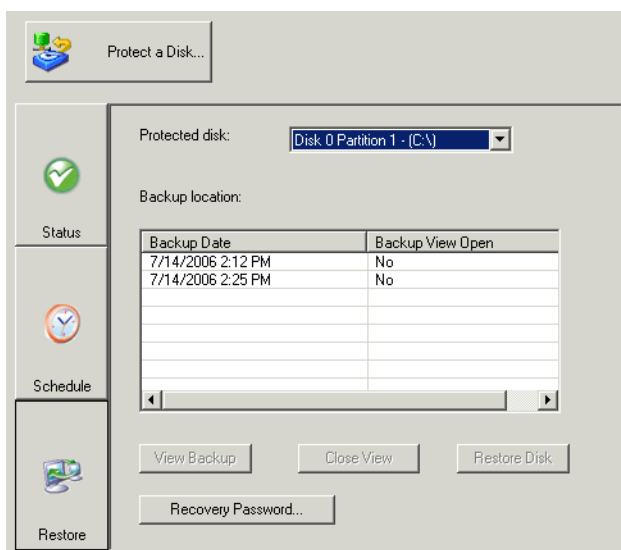

2. In the **Protected disk** list, select the disk or partition that you want to recover.
3. In the **Backups** list, select the backup that you want to recover.
4. Click **Restore Disk**.

5. If you are restoring a partition, and at least one other partition on the same disk is also protected, a message displays, advising you that protection is stopped for that partition during the recovery process. Click **Yes** to proceed.
6. When the recovery confirmation message displays, click **Yes**.
7. If any backup views are open, including backup views of disks other than the one you are recovering, click **Yes** to close them.

The disk or partition is recovered to exactly its state at the date and time of the selected backup.

To let you monitor the progress of this activity, the **Status** page displays automatically. The **Current activity** area displays the percentage of the recovery that has completed, and the speed at which the data is being sent over the network. The **Progress** bar graphically indicates how much of the recovery is complete.

***Note:** You can cancel this operation at any time by clicking **Stop Current Activity**. However, this leaves the local disk or partition in an incomplete state, and you have to recover it again before you can use it.*

8. When you are prompted to restart the computer, click **OK**.

You do not have to restart your computer immediately, but you cannot access the recovered disk or partition until you do.

As soon as you restart the computer, you must start Intel® Client Backup and Recovery and back up the recovered disk or partition manually, as described in [“Manually Backing up Your Disk” on page 105](#), to resume protection. In addition, if you recovered a partition and any other partitions on the same disk were protected, you must manually back up those partitions as well.

## Recovering a System Disk Using the Recovery CD

When you use the recovery CD, you boot your computer from that CD rather than from your local hard disk.

The recovery CD has a menu-style user interface. When responding to the prompts, use the arrow keys to highlight the desired item, use the space bar to select or clear options. An **x** displays in the brackets when the option is selected. Press Enter to make your selection. You can also tab between fields.

***Note:** The recovery CD does not support USB keyboards or mouse devices.*

Although the recovery CD is used primarily for recovering a system disk or partition, you can also use it to recover data disks or partitions.

The recovery CD can recover multiple partitions to a disk with existing partitions. It can also create one partition on a new disk. However, if you want to recover multiple partitions to a new disk, you must format and partition the disk before you use the recovery CD to recover the partitions.

In some cases, when you recover a disk using the recovery CD, an additional backup is created on the storage system. If the maximum number of backups has already been performed, the oldest backup is deleted to make room for this backup.

To recover a system disk or partition using the recovery CD:

1. Using the appropriate procedure for your computer, configure it to boot from the CD-ROM drive. For more information, see the documentation for your computer.
2. Insert the recovery CD into the CD-ROM drive. A welcome screen displays while the CD initializes.
3. If you have already verified that the recovery CD supports your local hardware, or if you have received a new recovery driver from your vendor, wait 25 seconds for **Normal Mode** to start automatically and go to step 4.

If this is the first time you have used the recovery CD, press any key to start **Diagnostic Mode**. The screen displays a list of all the devices found on your computer and whether or not they are compatible with the recovery CD. You can use the arrow keys to scroll through the list. If at least one supported network interface card (NIC) and one hard disk have been detected, select **Normal Mode** and go to step 4.

If no supported NIC is found, you can gather information about your computer and send it to Technical Support to see if an updated recovery CD or an appropriate driver is available. To do this, select **Save**, insert a formatted floppy disk or USB disk into your computer, and select the appropriate option (**Save to Floppy Disk** or **Save to USB Disk**). Once the file has been saved to the specified location, you can send it to Technical Support. Then select **Finish** and select **Yes** to restart your computer. At this point, you have 10 seconds to remove the recovery CD from your CD-ROM drive and boot from your local disk once more. Otherwise, your computer boots from the recovery CD again.

4. When the hardware list displays, take the desired action:

To do this	Do this
Proceed with recovering data	Select <b>Next</b> . You can select <b>Next</b> only if at least one supported NIC is listed.
Load a new recovery driver	Select <b>Load Driver</b> , select the location from which you want to install the driver: <ul style="list-style-type: none"> <li>• <b>Load From System</b> for the local hard disk</li> <li>• <b>Load From Floppy Disk</b> for a floppy disk</li> <li>• <b>Load From CD</b> for a CD</li> <li>• <b>Load From USB Disk</b> for a USB disk</li> </ul> Insert the disk if loading from a floppy disk, CD, or USB disk, and respond to the prompts.
See a complete list of the detected hardware	Select <b>Diagnostic Mode</b> . When you are done viewing the list, select <b>Normal Mode</b> .

- Review the network settings for your NIC and select **Next**.

The recovery CD obtains the IP address to use from your DHCP server. If the displayed settings are not the ones you want to use, or if no IP address is displayed, select the NIC in the list, select **Config**, specify the desired IP address, subnet mask, and default gateway, and select **OK**.

If multiple NICs are listed, Intel<sup>®</sup> Client Backup and Recovery uses the last NIC whose **Status** is **Enabled**. If you do not want to use the last listed NIC, select **Config** and then select **Disable** to change the **Status** to **Disabled**. Repeat this procedure for each NIC that you do not want to use. Then select **Next**.

- In the **Computer Name** field, enter the full computer name of this computer.

If you do not remember the full computer name, access the Manager, as described in [“Accessing the Manager” on page 25](#), and click **Backups** in the navigation bar. In the **Protected disks** group box, the **Computer Name** column lists the computer name of each computer that has backed up disks to the storage system.

- If your computer is a member of a Windows domain, enter the domain name in the **Domain Name** field. If your computer is not a member of a Windows domain, leave this field blank.

Initially, the recovery CD attempts to connect to the storage system using only the computer name. If this fails, the domain name is appended as well. This ensures that your computer can be properly authenticated.

- In the **Storage System** field, enter the name or IP address of the storage system where the backups reside.

***Note:** You can use the storage system name only if your computer is in the same subnet as the storage system or if you manually registered the name with a DNS server in your network.*

- In the **Recovery Password** field, enter the recovery password that you specified when you protected the disk or when you last changed the password, and then select **Next**.

If you do not remember your password, you can change it on the storage system, as described in [“Changing the Recovery Password” on page 59](#), and enter the new password.

- In the left column, select the disk or partition that you want to recover.

If you protected only one disk or partition, only one item displays in this list.

If you protected multiple disks or partitions, you can identify the correct item by looking at the **Attr**, **Disk ID**, and **Size** columns. **Attr** column displays the attributes of each listed item (**D** for disk, **P** for partition, and **S** for system disk). For example, if you protected both a system partition and a data partition, the system partition is labeled **PS**, and the data partition is labeled **P**.

The **Size** column displays the number of megabytes. This column can also help you identify the right item. You can also compare the disk ID with the listed backup disk IDs in the Manager as described in [“Managing Backups” on page 58](#).

If you protected the same disk more than once, such as if you removed protection and then protected the disk again without re-using the existing backup, the attributes and size of each backup of that disk is the same. To determine which item to select, select



each one individually and look at the times and dates in the right column. This can help you identify which image is the most recent.

11. In the right column, select the date and time of the backup that you want to recover.

**Caution:** *Selecting a backup with a specific date/time stamp is strongly recommended.*

*In most cases, selecting **Latest Backup** is the same as selecting the backup in the list with the most recent date/time stamp. However, if the most recent backup is marked <Protect>, the **Latest Backup** is in an incomplete state. In that case, be sure to select one of the other listed backup dates rather than **Latest Backup**.*

*If nothing displays in this column besides **Latest Backup**, do not recover this disk or partition. In this situation, Latest Backup represents only the empty storage space allocated for the backup and contains no data to recover. You can press Ctrl+Alt+Delete to exit the recovery CD.*

If you select Latest Backup, an additional backup of the selected backup is created. As a result, if the maximum number of backups has already been performed, the oldest backup is deleted to make room for this backup. Backups created by the recovery CD are identified in this list by the word <Recovery>.

To update the information on this screen, select **Refresh**. This is helpful if you are recovering data from one computer to another and a new disk was protected or a backup occurred after this screen was displayed.

12. If you selected a backup other than Latest Backup, specify whether or not to delete all backups that occurred after the selected date by selecting or clearing **Delete all later backups**.

**Caution:** *This action is not reversible. If you select this option, you are not able to subsequently recover from another later backup*

*In addition, you can select this option only if you selected an older backup from the list; you cannot select this option if you selected <Latest Backup>.*

13. Specify whether or not to scan for differences between the backup and your local disk by selecting or clearing **Enable microscan**, and then select **Next**.

If you are simply overwriting corrupted data on the same disk that you protected previously, select this option. Only the data that differs between the backup and the local disk is copied to the local disk. This can minimize the impact to the network, although the scanning process takes some additional time.

If you are recovering the backup to a new disk, clear this option. All the data from the backup is copied to the new disk without any scanning since there is nothing to scan on the new disk.

14. Select the local disk where you want to recover the data, and select **Next**.



**Note:** *If you replace the original hard disk, the new disk must be at least as large as the original disk. You must also connect the new hard disk to the same location as the original one. If this is not done, there may be a problem after restoration.*

*In addition, if you are recovering a system disk, the system to which you are recovering the data must be identical to the original system. For example, if the original system had a particular type of network adapter, the system to which you are recovering the data must have the exact same type of network adapter. Otherwise, the recovered files do not operate properly.*

15. If you selected a disk in step 10, go to step 18.

If you selected a partition in step 10, select **Recover to an existing partition** to recover to an existing partition on the selected disk, or select **Reformat the local disk and recover to a new partition** to delete all the existing data on the selected disk and recover only the selected partition.

16. If you selected **Recover to an existing partition** in step 15, select the partition where you want to recover the data, and then select **Next**. Otherwise, go to step 18.

For system partitions, the **Active** column displays **Yes**.

17. If the selected partition is the original partition, go to step 18.

If the selected partition is not the original partition, select **Yes** to use the selected partition, or select **No** and select a different partition.

18. Select **Yes** to confirm the recovery.

**Caution:** *This overwrites any existing data on the selected disk. Although you can subsequently recover different data, you cannot recover the original data.*

The status screen displays the progress of the recovery. You can cancel it at any time by selecting **Cancel**. However, this leaves the disk or partition in an incomplete state. Some of the data is recovered, but not all of it.

19. When the completion screen displays, review the results and do one of the following:

To do this	Do this
Recover another disk or partition	<p>Select <b>Recover Another Disk</b>.</p> <p>If you want to recover a different backup of the same computer from the same storage system, select <b>No</b> to retain the current configuration settings and return to step 10.</p> <p>If you want to recover a different computer's backup, or if you want to recover a backup from a different storage system, select <b>Yes</b> to modify the current configuration settings and return to step 6.</p>
Restart the computer	<p>Select <b>Restart Computer</b>.</p> <p>When the informational message displays, select <b>OK</b>.</p> <p>When prompted to confirm that you want to restart the computer, select <b>Yes</b>.</p> <p>You have 10 seconds to remove the recovery CD from the CD-ROM drive.</p>

20. When the computer restarts, use the appropriate procedure for your system to configure the computer to boot from the local hard disk once more.
21. If you changed the recovery password on the storage system, reset it in the Microsoft iSCSI Initiator\* as described in [“Resetting the Recovery Password in the Microsoft iSCSI Initiator\\*”](#) on page 166.
22. Start Intel® Client Backup and Recovery and remove protection from the recovered disk or partition as described in [“Removing Protection”](#) on page 126.
23. Protect the recovered disk once again as described in [“Protecting Your Disks”](#) on page 98, re-using the original backup.

## Recovering a System Disk While Booting Remotely

If your computer meets the prerequisites, you can remotely boot it from a backup on your storage system and recover your system disk or partition. You can recover only your most recent backup.

**Note:** *If you replace the original hard disk, the new disk must be at least as large as the original disk. You must also connect the new hard disk to the same location as the original one. If this is not done, there can be a problem after restoration.*

*In addition, the system to which you are recovering the data must be identical to the original system. For example, if the original system had a particular type of network adapter, the system to which you are recovering the data must have the exact same type of network adapter. Otherwise, the recovered files do not operate properly.*

## Prerequisites

Before you recover a disk while booting remotely, the following criteria must be met:

- The computer that you are remotely booting must be in the same subnet as the storage system.
- Remote boot must be enabled for that computer as described in [“Enabling Remote Boot”](#) on page 111.
- At least one backup must have been performed after remote boot was enabled.
- The network must have a DHCP server, or your storage system must be configured to act as a DHCP server as described in [“Changing the Network Settings”](#) on page 68.
- If you plan to remotely boot your computer from a different computer’s backup, you must enter the MAC address of your computer’s network interface card (NIC) on the storage system. For more information, see [“Configuring Remote Boot”](#) on page 59.
- If you want to remotely boot from any backup other than the most recent one, you must select the desired backup on the storage system. For more information, see [“Configuring Remote Boot”](#) on page 59.

## Recovering the Disk

To recover a system disk or partition while booting remotely:

1. Start your computer.
2. Use the appropriate procedure for your system to configure it to boot from the NIC.  
For example, you might press F12 when the boot menu displays. For more information, see the documentation for your computer.  
When the computer restarts, allow it to boot from the NIC. You might be prompted to press F1 to continue.
3. When prompted, press F8. You have a limited amount of time to do this.
4. Using the arrow keys, select **Remote Boot (Windows)** and then press Enter.
5. When prompted, enter the password that you specified when you protected the system disk or when you last changed the password for that disk.

If you do not remember your password, you can change it on the storage system, as described in [“Changing the Recovery Password” on page 59](#), and enter the new password.

6. If any error messages display, click **OK**.
7. Log in as you normally would. The message **Network Boot Mode** displays on the screen to confirm that you are working from the storage system.

**Caution:** *You can open and change files while remotely booting, and even create new files or folders. However, only the data that existed at the time and date of the selected backup is recovered. If you want to save any new data, you must copy the files or folders to a different location, such as a network server.*

8. Start Intel<sup>®</sup> Client Backup and Recovery.

**Caution:** *While booting remotely, do not try to use Intel<sup>®</sup> Client Backup and Recovery for any operation other than recovering the system disk.*

9. When a warning message displays, advising you that the computer name has changed, click **OK**.
10. Click **Restore**.

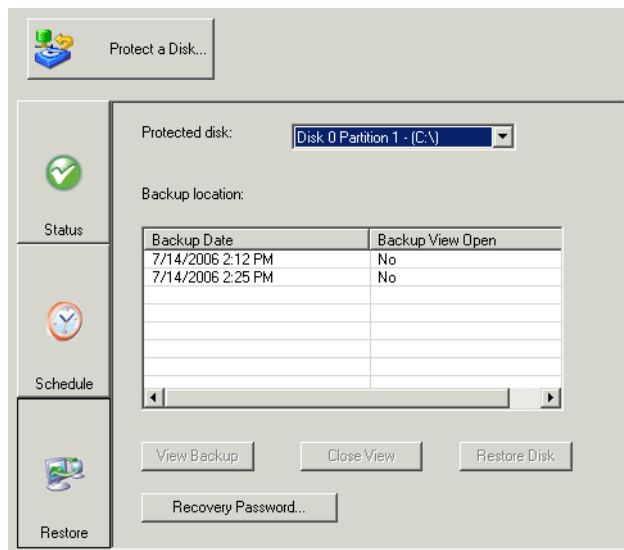

The **Protected disk** list displays the disk or partition that you are currently booting from.

11. In the **Backups** list, select the most recent backup. You can recover only the most recent backup.

**Note:** *If no backups display in this list, the backup that you booted from is not using the same recovery password as the storage system. This can occur if you changed the recovery password on the storage system before booting remotely, or if you changed it between backups in Intel® Client Backup and Recovery and booted from an earlier backup. To resolve this issue, you must reset the password in the Microsoft iSCSI Initiator\* as described in [“Resetting the Recovery Password in the Microsoft iSCSI Initiator\\*”](#) on page 166. Then restart Intel® Client Backup and Recovery.*

12. Click **Restore Disk**. The Restore dialog box displays.

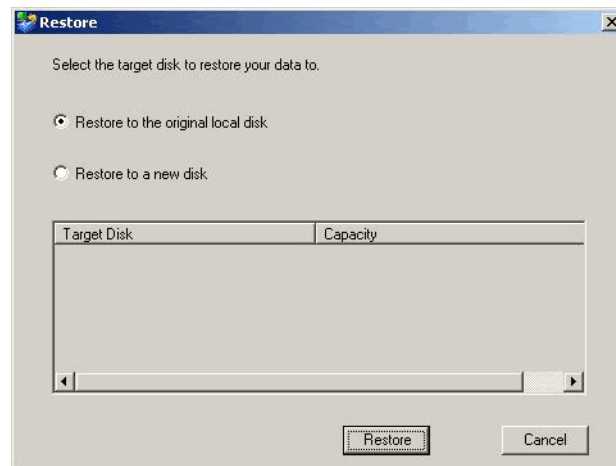

13. Specify whether you are recovering to the original disk or a new disk.

If you are recovering to a new disk, select the desired disk from the list. Then click **Restore**.

14. When the confirmation message displays, click **Yes**.

The backup is recovered to your local disk, and the progress bar displays the progress of this process. You can cancel the recovery at any time by clicking **Stop** on the progress dialog box.

***Note:** Do not shut down your computer, disconnect from the network, or perform any other tasks until this process is complete.*

15. After the recovery is complete, click **OK** to restart your computer.

16. Use the appropriate procedure for your computer to configure it to boot from the local disk once more.

17. If you changed the recovery password, reset it in the Microsoft iSCSI Initiator\* after your computer restarts as described in [“Resetting the Recovery Password in the Microsoft iSCSI Initiator\\*”](#) on page 166.

18. Start Intel® Client Backup and Recovery and remove protection from all your disks and partitions as described in [“Removing Protection”](#) on page 126. This disables remote boot and restarts your computer. Then protect them again as described in [“Protecting Your Disks”](#) on page 98, reusing the existing backups.

If you need to recover other data disks or partitions, you can do so as described in [“Recovering a Data Disk”](#) on page 116. However, be sure to do this after you have removed protection and then reprotected the disks.

19. Enable remote boot again as described in [“Enabling Remote Boot”](#) on page 111.

## Removing Protection

If you no longer want to back up a particular disk or partition, you can remove protection as long as a recovery is not currently in progress for that disk or partition. If a recovery is in progress, you must cancel it or wait until it completes before you can remove protection.

**Note:** *If you plan to delete a protected partition, be sure to remove protection before you delete that partition. Otherwise, you might not be able to protect other partitions on that disk.*

When you remove protection for a disk for which remote boot is enabled, remote boot is disabled and your computer restarts.

When you remove protection, you no longer can back up the selected disk or partition either automatically or manually, and you cannot recover data using Client Backup and Recovery as described in [“Recovering Files or Folders” on page 114](#) and [“Recovering a Data Disk” on page 116](#). However, the backups that currently exist on the storage system are retained, and you can recover them using the recovery CD as described in [“Recovering a System Disk Using the Recovery CD” on page 117](#).

If you subsequently want to protect the same disk or partition again, you can re-use the existing backups. You can also delete the existing backups on the storage system to free up space for backups of other disks or partitions, either for this computer or other computers. For more information, see [“Deleting a Backup” on page 60](#) the documentation for your storage system.

To remove protection:

1. In the **Protected disk** list on any page, select the disk for which you want to remove protection.
2. From the **Action** menu, click **Remove Protection**.
3. Click **Yes** at the confirmation message.

The disk disappears from the **Protected disk** list. If another disk is protected, that disk displays in the **Protected disk** list, and information about that disk displays in the application window. If no other disk is protected, click **OK** on the informational message; the **Protected disk** list and application window are blank.

4. If remote boot was enabled, it is disabled. When prompted, click **OK** to restart your computer.

# 6 Adding or Replacing Hard Disks

---

## Adding Hard Disks

The effect of adding hard disks to your storage system varies, depending on the disk configuration you chose when you configured the system and the current state of the existing disks.

For example, in a linear configuration, you can add a new disk at any time, and data can be written to that disk as soon as it is added. Access to the disks is temporarily interrupted while the disk is being added. Whether you previously removed a disk or one of the other disks failed makes no difference.

In a RAID configuration, the effect of adding a disk varies, depending on whether the RAID is in a normal or degraded state as indicated on the disks page; see [“Reconfiguring Your Storage System Disks” on page 71](#). A normal state indicates that the RAID is functioning properly. A degraded state indicates that one or more disks have been removed or failed, but because of the data protection offered by the RAID, you can continue to access all the data. RAID 0 offers no data protection.

In a normal state, you cannot add a disk to a RAID 0 or RAID 1 configuration. Any disk that you install is not be used unless you subsequently reconfigure the storage system as described in [“Reconfiguring Your Storage System Disks” on page 71](#).

**Caution:** *Reconfiguring your storage system disks deletes all the data on your storage system.*

However, if you currently have three disks and a RAID 5 configuration, you can add a fourth disk as a spare, essentially changing from RAID 5 to RAID 5 + spare while retaining all existing data.

In a degraded state, you can add a disk to a RAID at any time, and the new disk is rebuilt to replace the disk that was removed or failed.

**Caution:** *If the RAID has failed—that is, if so many disks have failed or been removed that the RAID can no longer function—you must either re-install the disks or reconfigure the entire storage system, deleting all the data on your system.*

Although you can add a disk of any size to a linear configuration, any new disk that you add to a RAID configuration must be the same size as or larger than the smallest existing disk in the RAID.

## Adding Hard Disks to a Linear or Normal RAID Configuration

To add a hard disk to a linear or normal RAID configuration:

1. Insert the hard disk into the storage system. The drive LED turns green once the hard disk is recognized. You can do this whether the storage system is powered on or off.
2. Access the Manager or refresh the browser window. The **Disk Change Notification** page appears:

### Disk Change Notification

One or more hard disks in the storage system have failed or been added or removed.

If you add or remove disks at this time, click Scan after each change to update the list of current disks. (If you add disks, please wait until the disk LED is green before you click Scan.) To power off the storage system, click Shut Down. The other available options vary, depending on the nature of the change.

Current state: RAID 5 (NORMAL, Resync : 21 %, Finish : 627 min, Speed : 4367K/sec)

Previous disks

Slot	Model	Serial Number	Size	Disk Status
1	ST3250823A5	3ND05VJH	232.89 GB	RAID 5
2	ST3250823A5	3ND0551R	232.89 GB	RAID 5
3	ST3250823A5	3ND05EDM	232.89 GB	RAID 5
4	-	-	-	-

Current disks

Slot	Model	Serial Number	Size	Disk Status
1	ST3250823A5	3ND05VJH	232.89 GB	RAID 5
2	ST3250823A5	3ND0551R	232.89 GB	RAID 5
3	ST3250823A5	3ND05EDM	232.89 GB	RAID 5
4	HD5728080PLA380	PFDB2054RVTZVJ	232.89 GB	New

Scan
Shut Down
Add New Disk

3. To add the disk to the storage system, click **Add New Disk**.

If the information on this page is not correct, click **Scan** to scan the storage system again and update the page.

You can also click **Shut Down** to shut down the storage system, but you are presented with this page again the next time you access the Manager.

When you click **Add New Disk**, the following page appears:



### Add New Disk

One or more new disks have been added to the storage system.

If the list of new disks shown here is not correct, click **Back** and then click **Scan** to update it. To add new disk to your current disk configuration, click **Add**. To proceed without adding the disk to your current disk configuration, click **Ignore**.

 For a linear configuration, click **Add** to immediately begin using the available disk space. For a three-disk RAID 5 configuration in a normal state, click **Add** to use the new disk as a spare. For any other RAID configuration, click **Ignore**; you cannot add a new disk to an otherwise normal RAID without reconfiguring the RAID.

Current state: RAID 5 (NORMAL, Resync : 21 %, Finish : 514 min, Speed : 5301K/sec)

Slot	Model	Serial Number	Size	Disk Status
1	-	-	-	-
2	-	-	-	-
3	-	-	-	-
4	HDS728080PLA380	PFDB2054RVTZVJ	232.89 GB	New

Back
Ignore

4. Take the desired action:

To do this	Do this
Add the disk to a linear configuration or use it as a spare for a normal three-disk RAID 5 configuration	Click <b>Add</b> . The <b>Disks</b> page indicates the current state of the disk configuration.
Add the disk to the storage system but not add it to the RAID at this time	Click <b>Ignore</b> . The <b>Disks</b> page lists the disk is part of the storage system, but its status is <b>New</b> , indicating that it is not being used.  If you subsequently reconfigure the disks as described in <a href="#">"Reconfiguring Your Storage System Disks"</a> on page 71, you are able to use this new disk.
Return to the previous page, for example, to re-scan the storage system	Click <b>Back</b> .

## Adding Hard Disks to a Degraded RAID Configuration

To add a hard disk to a degraded RAID configuration:

1. Insert the hard disk into the storage system.

You can do this whether the storage system is powered on or off.

2. Access the Manager or refresh the browser window.

The **Disk Change Notification** page appears:

### Disk Change Notification

One or more hard disks in the storage system have failed or been added or removed.

If you add or remove disks at this time, click Scan after each change to update the list of current disks. (If you add disks, please wait until the disk LED is green before you click Scan.) To power off the storage system, click Shut Down. The other available options vary, depending on the nature of the change.

Current state: RAID 5 (DEGRADED, Recovery : 0 %, Finish : 1012 min, Speed : 3445K/sec)

Previous disks

Slot	Model	Serial Number	Size	Disk Status
1	ST3250823A5	3ND05VJH	232.89 GB	RAID 5
2	ST3250823A5	3ND0551R	232.89 GB	RAID 5
3	-	-	-	-
4	-	-	-	-

Current disks

Slot	Model	Serial Number	Size	Disk Status
1	ST3250823A5	3ND05VJH	232.89 GB	RAID 5
2	ST3250823A5	3ND0551R	232.89 GB	RAID 5
3	ST3250823A5	3ND05EDM	232.89 GB	Rebuilding
4	-	-	-	-

Scan
Shut Down
Continue

3. Click **Continue** to continue rebuilding the disk and return to the Manager. The **Disks** page shows the progress of the rebuilding progress.

If the information on this page is not correct, click **Scan** to scan the storage system again and update the page.

You can also click **Shut Down** to shut down the storage system. When you restart the storage system, this page re-appears.

## Removing Hard Disks or Responding to a Disk Failure

The effect of removing hard disks from your storage system or a disk failure varies, depending on the disk configuration you chose when you configured the system and the current state of the existing disks.

For example, in a linear configuration, when you remove a disk or a disk fails, the data associated with that disk is no longer available, but the data on all the other disks remains available.

In a RAID configuration, the effect of disk removal/failure varies, depending on the RAID level and whether the RAID is in a normal or degraded state. You can determine the effect of disk removal/failure by looking at the **Hotplug Indicator** on the **Disks** page. If this indicator is **GREEN**, disk removal/failure has no effect on the RAID. If this indicator is **YELLOW**, disk removal/failure causes RAID degradation, but you still can access all the data. If the indicator is **RED**, disk removal/failure causes the entire RAID to fail.

For example, in a RAID 5 configuration, all the disks are **YELLOW**. Removing any one of them causes the RAID to be degraded, but all the data is still available. However, after you remove one disk, all the other disks become **RED**, since removing any one of them at this point causes the entire RAID to fail.

**Note:** *In a linear configuration, the **Hotplug Indicator** is **RED** for all the disks because removing any one of them removes data from the storage system. However, this does not adversely affect any of the other disks.*

*In addition, while a disk is being rebuilt, all the other disks are **RED**, since removing any one of them at this point causes the RAID to fail.*

If you remove a viable disk and cause only RAID degradation, you can re-install the same disk and resume normal operation. For information about adding a disk, see [“Adding Hard Disks” on page 127](#).

**Note:** *If you remove two or more disks, you must re-install them in the reverse order to help maintain data integrity. For example, if you remove disk A from slot 1 and then remove disk B from slot 2, you must re-install disk B first, then disk A. You can put the disks back into different slots, but they must be re-installed in the opposite order from which they were removed.*

If you remove one or more viable disks and cause the entire RAID to fail, you can shut down the storage system, re-install the same disks, and then restart the storage system. As long as you re-install the original disks, the storage system should be able to resume proper operation, although the integrity of the data cannot be guaranteed. However, if you replace the removed disks with new disks, you must reconfigure your disks as described in [“Reconfiguring Your Storage System Disks” on page 71](#).

**Caution:** *Reconfiguring your disks deletes all the data on your storage system.*

## Responding to RAID Degradation

When disk removal/failure causes RAID degradation, the **Disk Change Notification** page appears when you access the Manager or refresh the browser window:

### Disk Change Notification

One or more hard disks in the storage system have failed or been added or removed.

If you add or remove disks at this time, click Scan after each change to update the list of current disks. (If you add disks, please wait until the disk LED is green before you click Scan.) To power off the storage system, click Shut Down. The other available options vary, depending on the nature of the change.

Current state: RAID 5 (DEGRADED, Resync : 0 %, Finish : 895 min, Speed : 3894K/sec)

Previous disks

Slot	Model	Serial Number	Size	Disk Status
1	ST3250823A5	3ND05VJH	232.89 GB	RAID 5
2	ST3250823A5	3ND0551R	232.89 GB	RAID 5
3	ST3250823A5	3ND05EDM	232.89 GB	RAID 5
4	-	-	-	-

Current disks

Slot	Model	Serial Number	Size	Disk Status
1	ST3250823A5	3ND05VJH	232.89 GB	RAID 5
2	ST3250823A5	3ND0551R	232.89 GB	RAID 5
3	-	-	-	-
4	-	-	-	-

Scan
Shut Down
Continue

Take the appropriate action:

<b>To do this</b>	<b>Do this</b>
Scan the storage system again and update the information on the page	Click <b>Scan</b> .
Re-install the same disk or install a new disk	Click <b>Shut Down</b> . After the storage system shuts down, install the disk and then restart the system. <b>NOTE:</b> If you are re-installing multiple disks, be sure to re-install them in the opposite order than you removed them.
Return to the Manager and continue to operate in a degraded mode	Click <b>Continue</b> .

## Responding to RAID Failure

When disk removal/failure causes the entire RAID to fail, the **Disk Change Notification** page appears when you access the Manager or refresh the browser window:

### Disk Change Notification

One or more hard disks in the storage system have failed or been added or removed.

 If you add or remove disks at this time, click **Scan** after each change to update the list of current disks. (If you add disks, please wait until the disk LED is green before you click **Scan**.) To power off the storage system, click **Shut Down**. The other available options vary, depending on the nature of the change.

Current state: Failed

Previous disks

Slot	Model	Serial Number	Size	Disk Status
1	ST3250823A5	3ND05VJH	232.89 GB	RAID 5
2	ST3250823A5	3ND0551R	232.89 GB	RAID 5
3	-	-	-	-
4	-	-	-	-

Current disks

Slot	Model	Serial Number	Size	Disk Status
1	ST3250823A5	3ND05VJH	232.89 GB	RAID 5
2	-	-	-	-
3	-	-	-	-
4	-	-	-	-

Scan
Shut Down
Reconfigure Disks

Take the appropriate action:

To do this	Do this
Scan the storage system again and update the information on the page	Click <b>Scan</b> .
Re-install the same disk	Click <b>Shut Down</b> . After the storage system shuts down, re-install the same disk and then restart the system. <b>NOTE:</b> If you removed multiple disks, be sure to re-install them in the opposite order than you removed them.
Reconfigure the storage system using the available disks	Click <b>Reconfigure Disks</b> and complete the system setup pages as described in <a href="#">"Configuring Your Storage System" on page 21</a> . <b>Caution:</b> Reconfiguring the storage system deletes all user information and all data on all the disks.

## Swapping Hard Disks

If you are using RAID 5 + spare or RAID 10, you can move the hard disks from one slot to another whether or not the storage system is running. However, if you do this when the storage system is running, you can swap only two disks, and you must restart the system after you swap the disks. If you swap the disks when the storage system is not running, you can swap all four disks, and the system functions as it previously did when you restart it.

**Note:** For RAID 5 + spare, if you swap the disks when the storage system is running, one of the swapped disks must be the spare.

For RAID 10, the swapped disks must be in different pairs. For example, you can swap disks 1 and 3 or disks 2 and 4, but not disks 1 and 2, as those are members of the same pair.

If the storage system is running when you swap the disks, the **Disk Change Notification** page appears as shown in the preceding section. Click **Shut Down** and then restart the system.

For all other disk configurations (linear, RAID 0, RAID 1, and RAID 5), you can swap the hard disks only when the storage system is powered off, and you can swap all four disks.

## Transferring Hard Disks to a New Storage System

If your storage system unit fails but the hard disks themselves are viable, you can transfer your existing hard disks to a new storage system, thereby preserving all your existing data.

To transfer hard disks to a new storage system:

1. Shut down both the old unit and the new unit.

**Caution:** If you do not shut down the new unit before you insert the hard disks, you are prompted to re-initialize the disks. If you do this, all the data on your hard disks is lost.

2. Transfer the hard disks to the new unit.
3. Connect the new unit to your network and power on the new unit.
4. Access the Manager for the new unit as described in [“Accessing the Manager” on page 25](#).

As long as the new unit is in the same subnet as the old unit, you can access the Manager using the same procedure you used previously. However, if the new unit is in a different subnet, you might have to install the Console on a computer in the same subnet as the storage system and use the Console to access it.

5. If the firmware in the flash memory of the new unit differs from the firmware on the hard disks, a message appears, prompting you to update the flash memory on the storage system with the firmware from the hard disks. Click **Update** to proceed. If you do not want to upgrade the firmware at this time, click **Shut Down** to shut down the system.

***Note:** If the firmware on your new unit is newer than the firmware on your hard disks, you might want to contact your vendor about obtaining the latest firmware. see [“Upgrading the Firmware”](#) on page 64 for information about upgrading to newer firmware.*

If no message appears, you can manage the unit as you did before.

## *Adding or Replacing Hard Disks*



# 7 Hardware Installations and Upgrades

---

This chapter provides instructions for removing, installing, and replacing storage system components in your Intel® Entry Storage System SS4000-E.

**Note:** *Maintenance procedures should be done by qualified technical personnel.*

**Caution:** *It is recommended that you fit and check a suitable anti-static wrist and conductive foam pad and observe all conventional ESD precautions when handling storage system modules and components. Avoid contact with the backplane components and module connectors.*

## Before You Begin

Before working with your storage system, review the important safety information listed in [Appendix H, “Safety Information”](#).

## Tools and Supplies Needed

- Phillips\* (cross head) screwdriver (#1 bit and #2 bit)
- Anti-static wrist strap and conductive foam pad (recommended)

## System References

All references to left, right, front, top, and bottom assume the reader is facing the front of the storage system as it would be positioned for normal operation.

## Removing or Installing the Enclosure Cover

**Warning:** *The enclosure cover must only be removed by a service personnel. Potential hazards include:*

- *Energy hazard*
- *Rotating fans*
- *Hot surfaces*
- *Access to power supply unit openings*

*Upon replacement, the cover MUST be secured by tightening the retaining screw with a screwdriver.*

## Removing the Enclosure Cover

**Important:** The cover should only be removed by qualified service personnel as it provides access to a service area.

**Note:** Before performing any maintenance on the storage system, back up all data. Shut down the storage system by selecting the Advanced tab from the Manager and then Shutdown from the left-hand menu.

1. Observe all safety and ESD precautions listed in [Appendix H, “Safety Information”](#).
2. If you are unable to shut down the system using the software Manager then power down the storage system by pressing and holding the power button for approximately five seconds until the System Status LED starts flashing. The storage system shuts off after a short shutdown period.

**Caution:** Ensure the system is completely shutdown before removing the power chord.

3. Disconnect the storage system from its power source.
4. Remove the four screws at the back of the enclosure cover. See letter “A” in the following figure. Slide the enclosure cover slightly rearward and then lift up. See letter “B”.

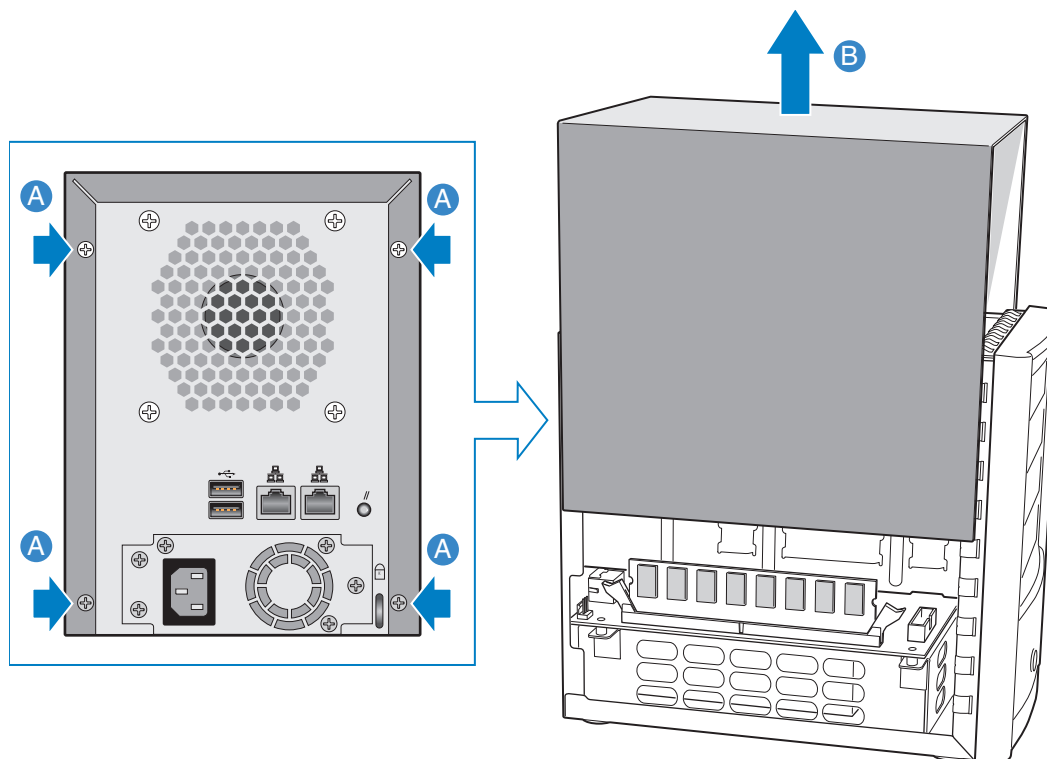

AF000231

**Figure 13. Removing Enclosure Cover**

## Installing the Enclosure Cover

1. Observe all safety and ESD precautions listed in [Appendix H, “Safety Information”](#).
2. Align the guide on the left and right sides of the enclosure cover with the edge at the bottom of the chassis and slide the enclosure cover downward. See letter “A” in the following figure. Secure the enclosure cover to the chassis with four screws. See letter “B”.

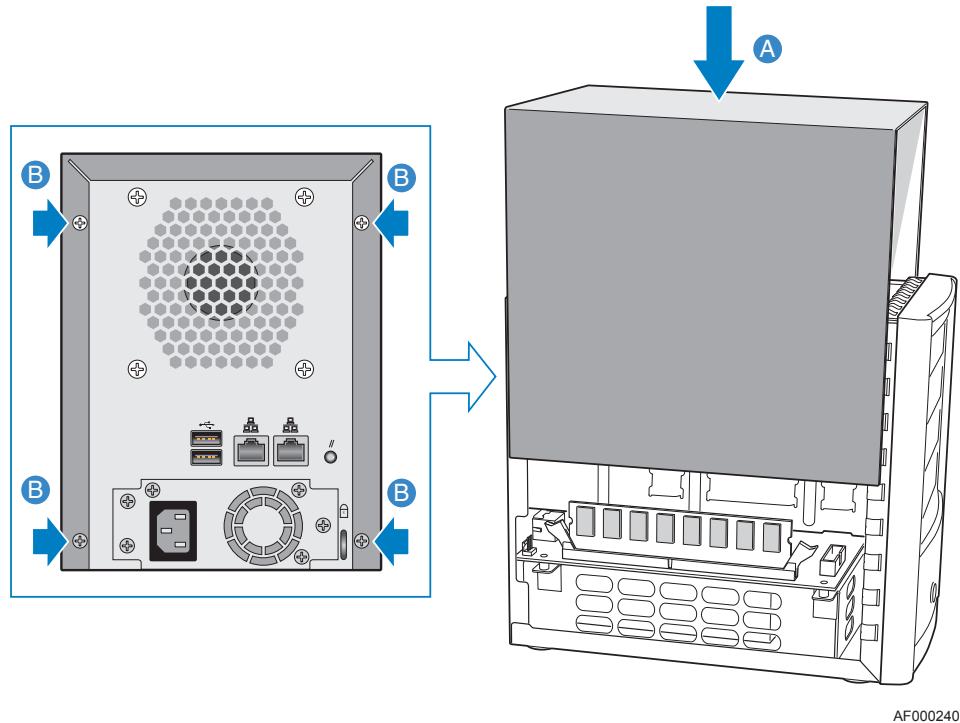

AF000240

**Figure 14. Installing Enclosure Cover**

3. Reconnect the storage system to its power source.
4. Power up the storage system by pressing the power button on the front of the unit. The System Status LED flashes green while the system is booting up.

## Replacing or Installing a Hard Disk

The Intel® Entry Storage System SS4000-E allows for easy installation and replacement of hard disks for any upgrade or repair. see [Chapter 6, “Adding or Replacing Hard Disks”](#) for additional information on adding hard disks to or removing hard disks from your system.

**Important:** *An empty drive carrier with a baffle installed, MUST be fitted in ALL unused drive bays. Cooling is inadequate if any drive bays are left open.*

**Note:** *At least one SATA hard disk with at least an 80-GB capacity must be installed. The Intel® Entry Storage System SS4000-E does not ship with any hard disks installed.*

**Caution:** *Before performing any maintenance, back up the data. Shut down the storage system by selecting the Advanced tab from the Manager and then Shutdown from the left menu.*

1. Observe all safety and ESD precautions listed in [Appendix H, “Safety Information”](#).
2. If you are unable to shut down the system using the software Manager then power down the storage system by pressing and holding the power button for approximately five seconds until the System Status LED starts flashing. The storage system shuts off after a short shutdown period.

**Caution:** *Ensure the system is completely shutdown before removing the power chord.*

3. Disconnect the storage system from its power source.

4. Press in the green latch at the end of the drive carrier to disengage the drive carrier from the storage system. Pull out on the black lever to pull the drive carrier out of the storage system.



TP000230

**Figure 15. Removing Drive Carrier from Storage System**

5. Remove the four screws that attach the plastic baffle or defective hard disk to the drive carrier. Two screws are located on each side of the drive carrier.

**Note:** Store the plastic baffle for future use.

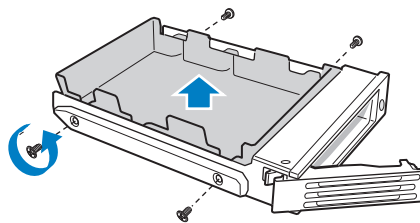

TP000928

**Figure 16. Removing Baffle from Drive Carrier**

6. Remove the hard disk from its wrapper and place it on an anti-static surface.

**Important:** Make sure the hard disk is a SATA disk. It should have a SATA connector similar to the one in the following figure.

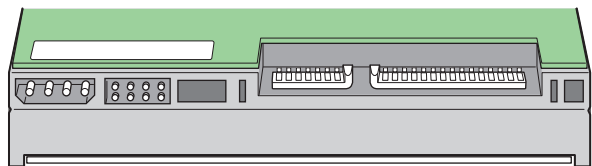

AF000306

**Figure 17. Rear View of SATA Hard Disk**

7. With the hard disk circuit-side down, position the connector end of the new hard disk so that it is facing the rear of the drive carrier. Align the holes in the new hard disk to the holes in the drive carrier and attach the new hard disk to the carrier with the screws that were removed in [Step 5](#).

**Note:** Do not remove the side rail on the right side of the drive carrier. This rail contains the light pipe that displays the LED light on the front of the drive carrier. If the side rail comes loose, check to ensure that the light pipe is properly inserted into the LED hole before reattaching the side rail to the drive carrier.

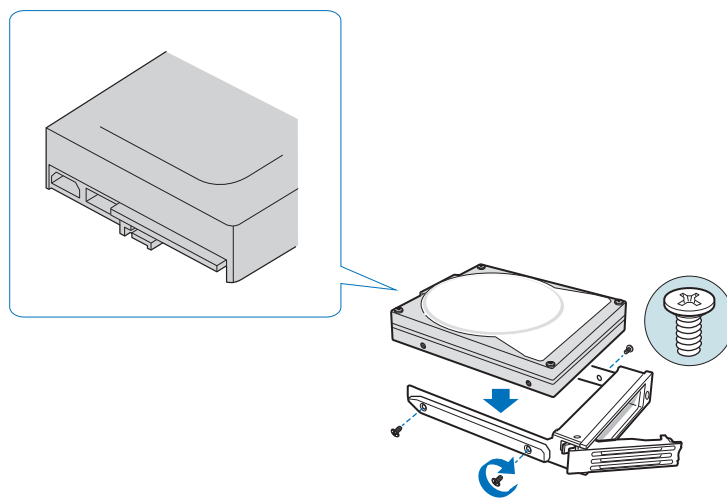

TP00929

**Figure 18. Installing Hard Disk into Drive Carrier**

- Label the hard disk appropriately. Starting with the uppermost drive, label the hard disks 1 to 4.

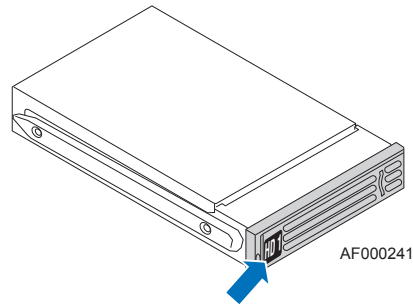

**Figure 19. Affixing Label to Drive Carrier**

**Important:** The order of drive carriers is critical when replacing hard disks or performing maintenance. A hard disk plugged into an incorrect slot once set up for RAID can result in data loss or an improperly functioning storage system.

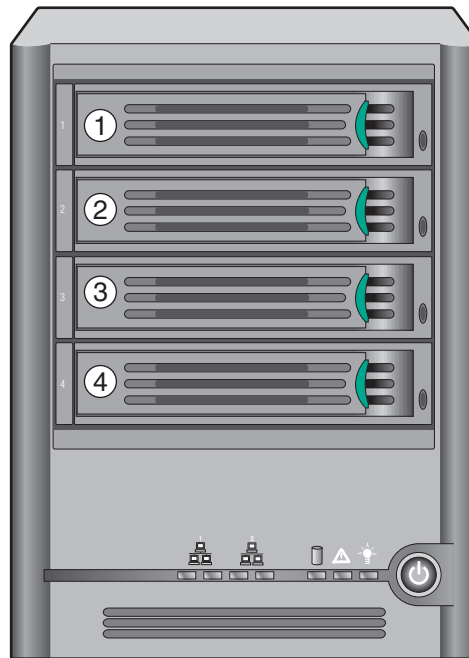

TP02348

**Figure 20. Order of Drive Carriers**

9. With the black lever in the fully open position, insert the drive carrier into the storage system. The green latch at the front of the drive carrier must be to the right of the storage system. Do not push on the black drive carrier lever until the lever begins to close by itself. Once the black drive carrier lever begins to close by itself, push on it to lock the driver carrier into place.

**Important:** Ensure that the drive carrier is orientated so that the hard disk is uppermost and the drive carrier lever opens from the right. Also, do not force the drive carrier into the storage system. If there is resistance, make sure that the drive carrier lever is in the fully open position.



TP02349

**Figure 21. Re-installing Drive Carrier into Storage System**

10. Reconnect the storage system to its power source.
11. Power up the storage system by pressing the power button on the front of the unit. The System Status LED flashes while the system is booting up.

**Notes:** If your hard drive was part of a RAID array previously, it rebuilds automatically.

If you are replacing a failed hard disk in a RAID array, the Drive Status LED blinks yellow until the array is rebuilt. Once the RAID is rebuilt, the Drive Status LED turns green indicating normal operation. If the RAID rebuild fails, the Drive Status LED turns a



*continuous yellow, indicating a fault condition. If this occurs, remove the hard disk from the storage system and check it or replace it with another hard disk.*

*When first installing hard disks to set up your storage system, the System Status LED turns yellow to indicate that the disks are not configured.*

*If you replace all of the hard disks with higher-capacity hard disks, you must go to Administrator to login and reconfigure the disks.*

## Replacing Power Supply

The power supply is located on the back of the Intel<sup>®</sup> Entry Storage System SS4000-E.

**Note:** *Replacement of the power supply should be done by qualified service personnel.*

**Note:** *Before performing any maintenance on the storage system, back up all data. Shut down the storage system by selecting the Advanced tab from the Manager and then Shutdown from the left-hand menu.*

1. Observe all safety and ESD precautions listed in [Appendix H, “Safety Information”](#).
2. Remove the new power supply from its protective packaging.
3. If you are unable to shut down the system using the software Manager than power down the storage system by pressing and holding the power button for approximately five seconds until the System Status LED starts flashing. The storage system shuts off after a short shutdown period.

**Caution:** *Ensure the system is completely shutdown before removing the power chord.*

4. Disconnect the storage system from its power source.

5. Remove the four screws at the back of the enclosure cover. See letter “A” in the following figure. Slide the enclosure cover slightly rearward and then lift up. See letter “B”.

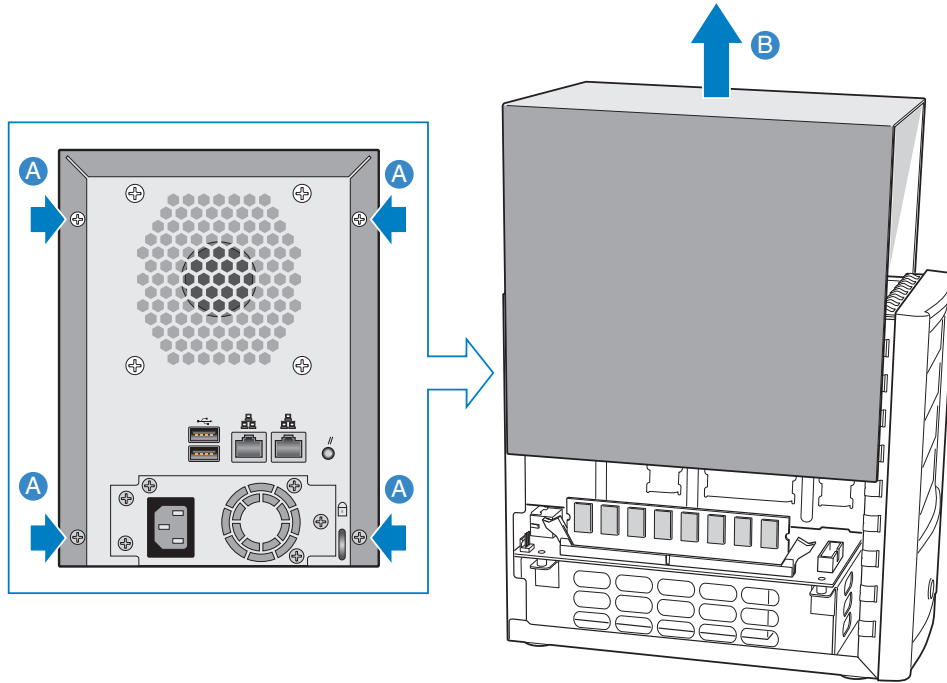

AF000231

**Figure 22. Removing Enclosure Cover**

- Remove the three screws securing the old power supply to the chassis. See letter “A” in the following figure.

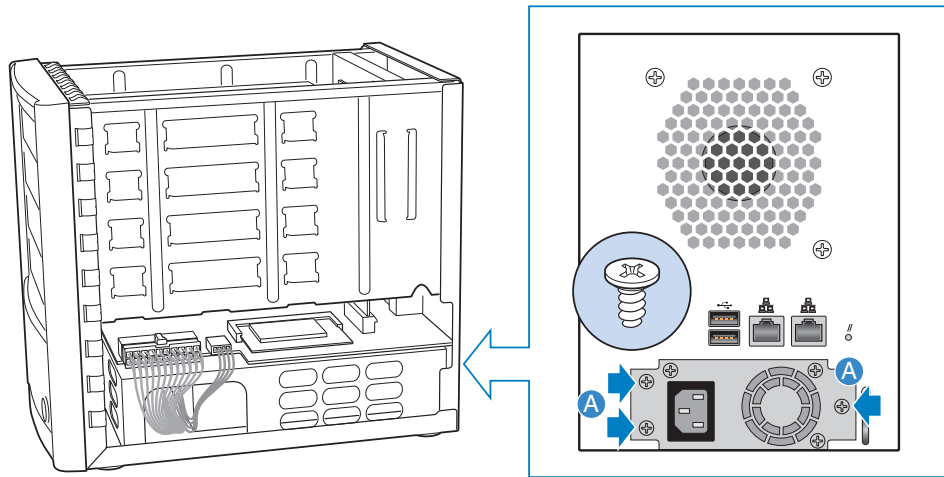

AF000292

**Figure 23. Detaching Power Supply from Chassis**

- Disconnect the large power cable. See letter “A”. Disconnect the small power cable. See letter “B”. Remove the old power supply from the chassis by sliding the old power supply towards the rear. See letter “C”. Slide the power cables through the opening in the power supply enclosure. See letter “D”.

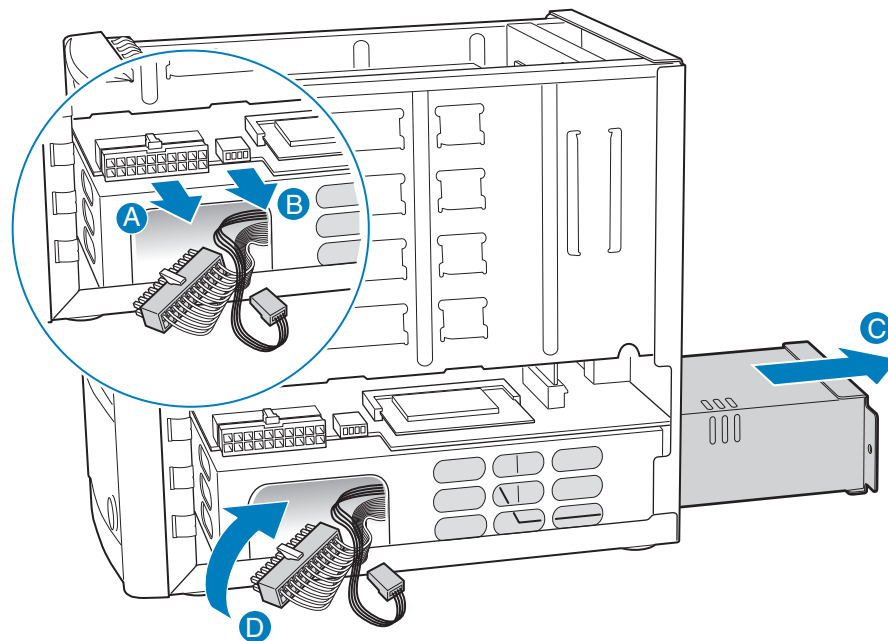

AF000293

**Figure 24. Disconnecting Power Cables and Removing Power Supply Cage**

8. Remove the three screws securing the power supply gasket to the old power supply. See letter “A” in the following figure.

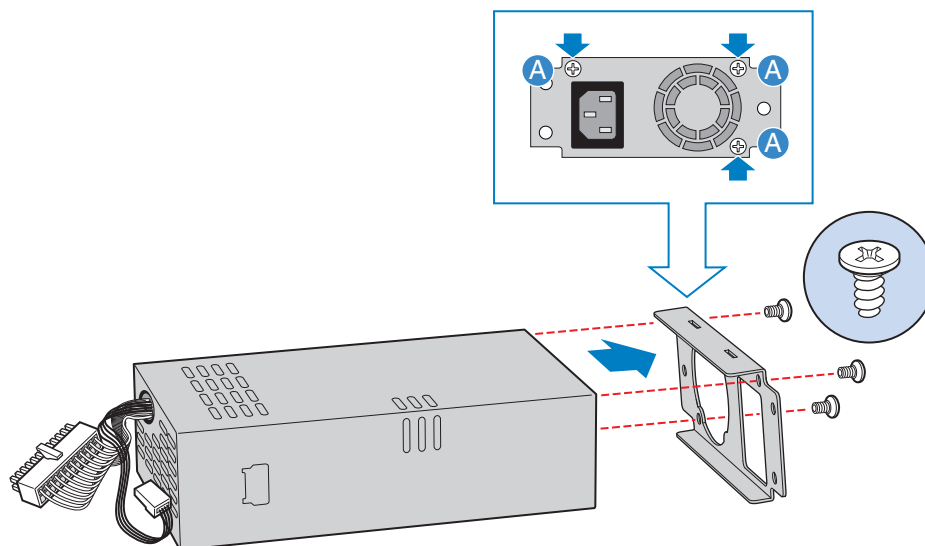

AF000301

**Figure 25. Removing Gasket from Old Power Supply**

9. Attach the power supply gasket to the new power supply with the three screws removed in the previous step. See letter “A” in the following figure.

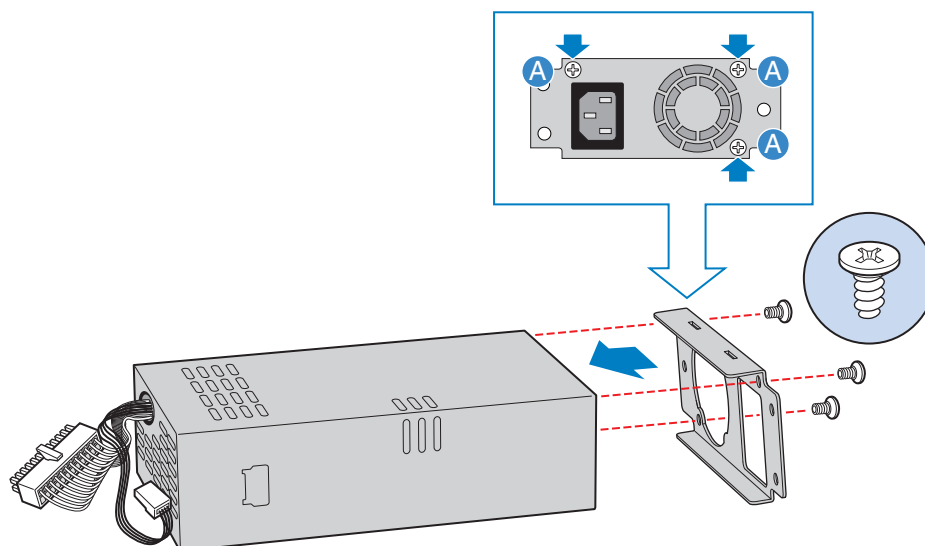

AF000302

**Figure 26. Installing Gasket on New Power Supply**

- Slide the new power supply cage into the chassis. See letter “A” in the following figure. Feed power supply cables through the opening in the side of the chassis. See letter “B”. Connect the small power cable to its connector on the system board. See letter “C”. Connect the large power cable to its connector on the system board. See letter “D”.

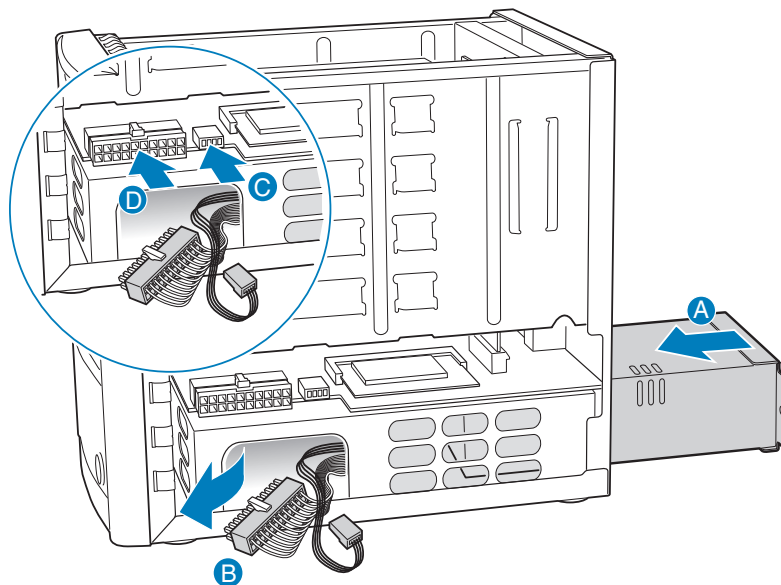

**Figure 27. Installing New Power Supply Cage**

- Secure the power supply cage to the chassis with three screws. See letter “A” in the following figure.

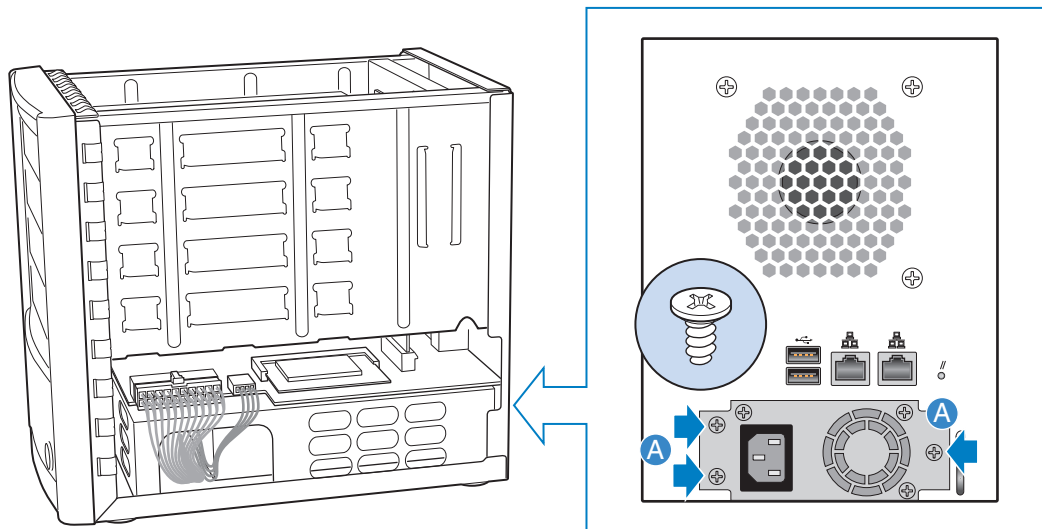

AF000292

**Figure 28. Securing New Power Supply Cage to Chassis**

- Align the guide on the left and right sides of the enclosure cover with the edge at the bottom of the chassis and slide the enclosure cover downward. See letter “A” in the following figure. Secure the enclosure cover to the chassis with four screws. See letter “B”.

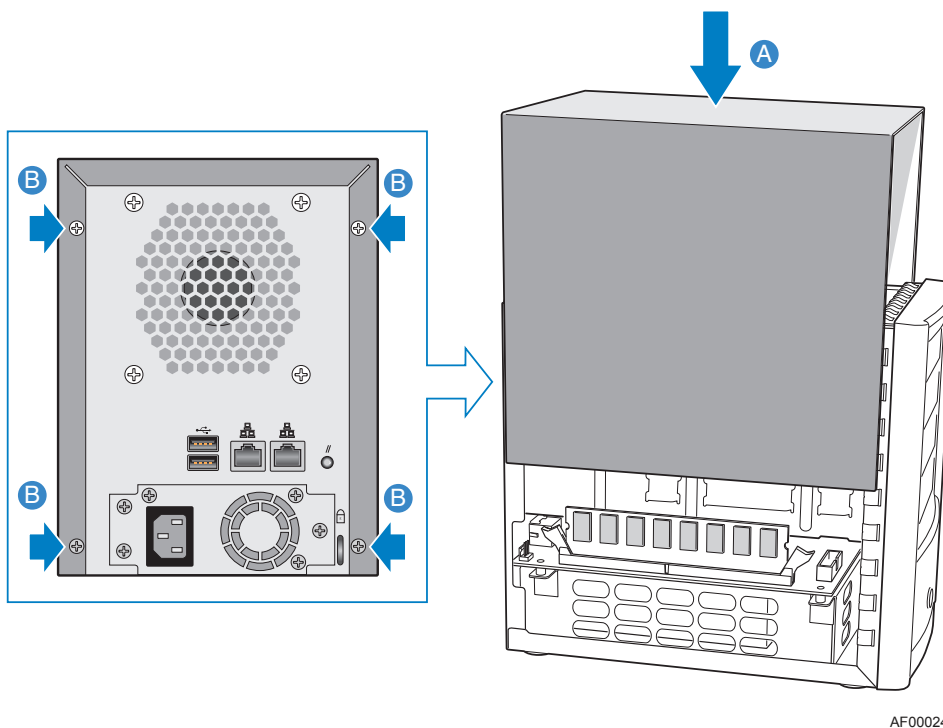

AF000240

**Figure 29. Installing Enclosure Cover**

- Reconnect the storage system to its power source.
- Power up the storage system by pressing the power button on the front of the unit. The System Status LED flashes while the system is booting up.

## Replacing System Fan

The system fan is located on the back of the Intel® Entry Storage System SS4000-E.

**Note:** Replacement of the system fan should only be done by qualified service personnel.

**Note:** Before performing any maintenance on the storage system, back up all data. Shut down the storage system by selecting the Advanced tab from the Manager and then Shutdown from the left menu.

1. Observe all safety and ESD precautions listed in [Appendix H, “Safety Information”](#).
2. Remove the new system fan from its packaging.
3. If you are unable to shut down the system using the software Manager then power down the storage system by pressing and holding the power button for approximately five seconds until the System Status LED starts flashing. The storage system shuts off after a short shutdown period.

**Caution:** Ensure the system is completely shutdown before removing the power chord.

4. Disconnect the storage system from its power source.
5. Remove the four screws at the back of the enclosure cover. See letter “A” in the following figure. Slide the enclosure cover slightly rearward and then lift up. See letter “B”.

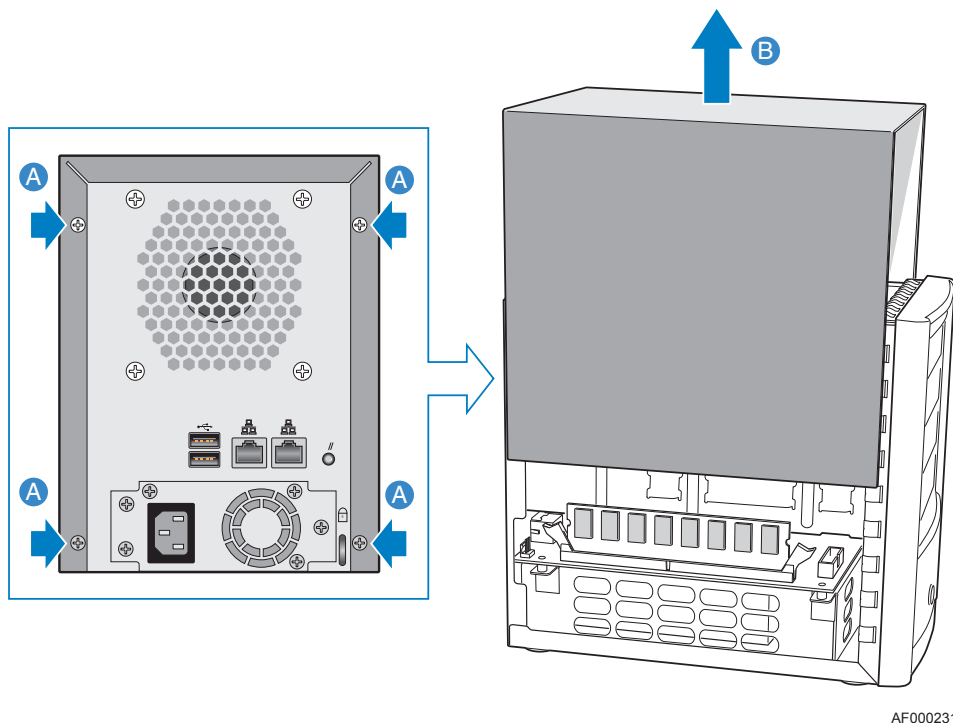

AF000231

**Figure 30. Removing Enclosure Cover**

6. Remove each of the drive carriers, starting with the topmost drive carrier.

**Note:** Note the order of the drive carriers as they are removed so as to ensure that each drive carrier can be re-installed later in its proper location.

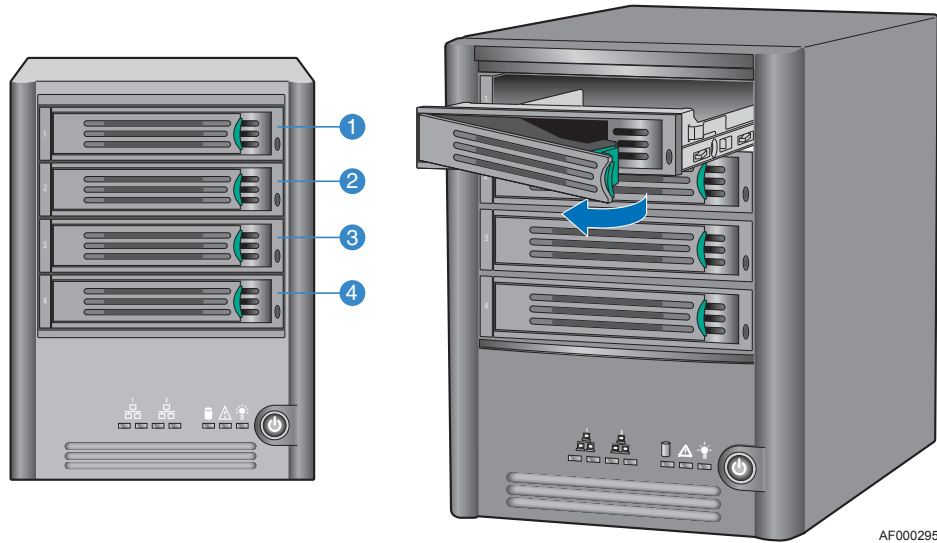

AF000295

**Figure 31. Removing Drive Carriers**



7. Remove the four hex-head screws, two per side, that secure the backplane assembly to the chassis. See letter “A” in the following figure. Disconnect the backplane assembly from its connector on the system board by pulling it up. See letter “B”. Lift the backplane assembly from the chassis. See letter “C”.

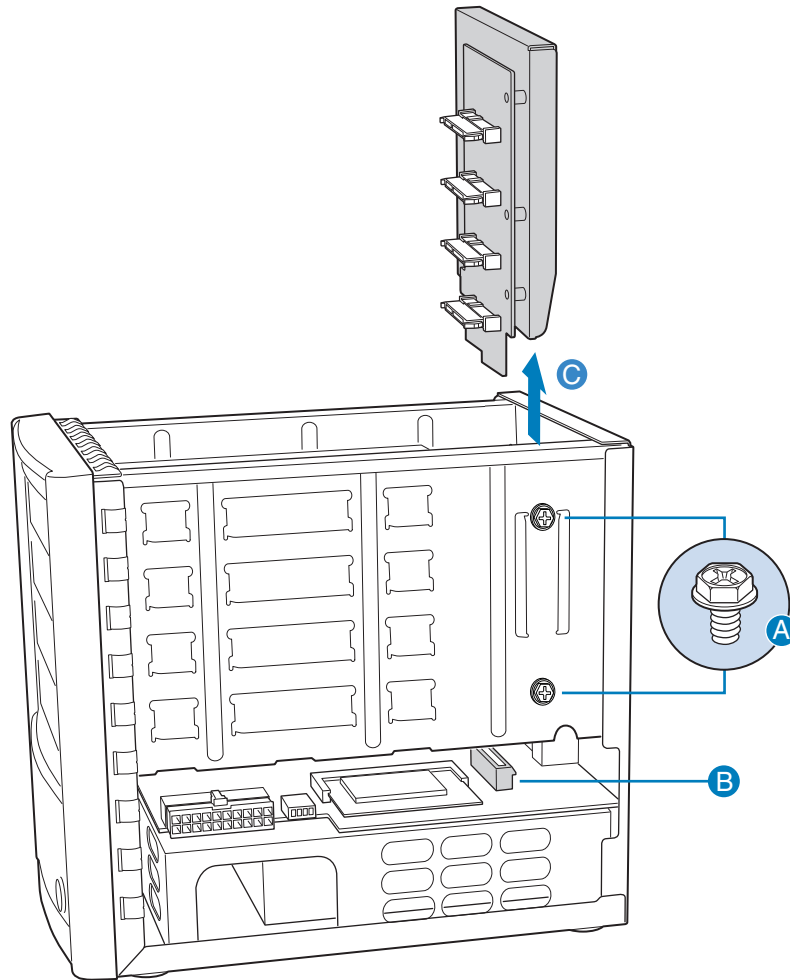

AF000296

**Figure 32. Removing Backplane from Chassis**

8. Disconnect the fan power cable from the system board. See letter “A” in the following figure. Remove the four screws securing the old system fan to the chassis. See letter “B”. Remove the old system fan from the chassis. See letter “C”.

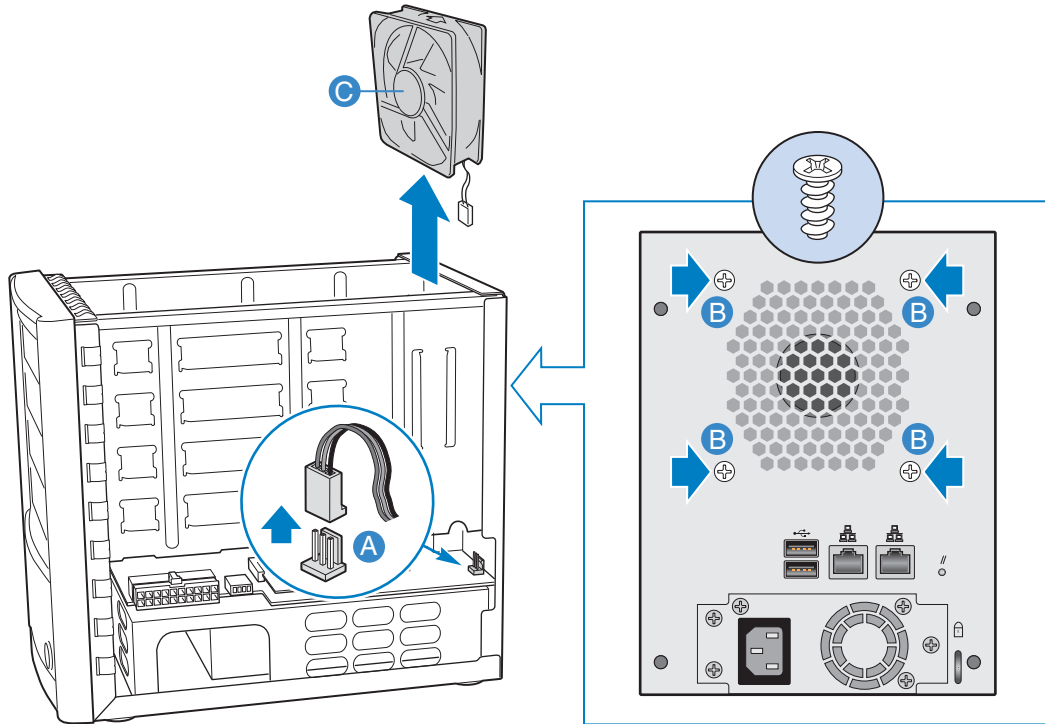

AF000297

**Figure 33. Removing System Fan**

- Before installing the new system fan, note the direction of airflow. Fan airflow exits the back of the chassis. See letter “A” in the following figure. Slide the new system fan into the chassis. See letter “B”. Align the holes in fan assembly with holes in chassis. See letter “C”. Secure the new system fan to the chassis with four screws. Route the fan cable through the opening provided in the chassis. See letter “D”. Connect the system fan power cable to its connector on the system board. See letter “E”.

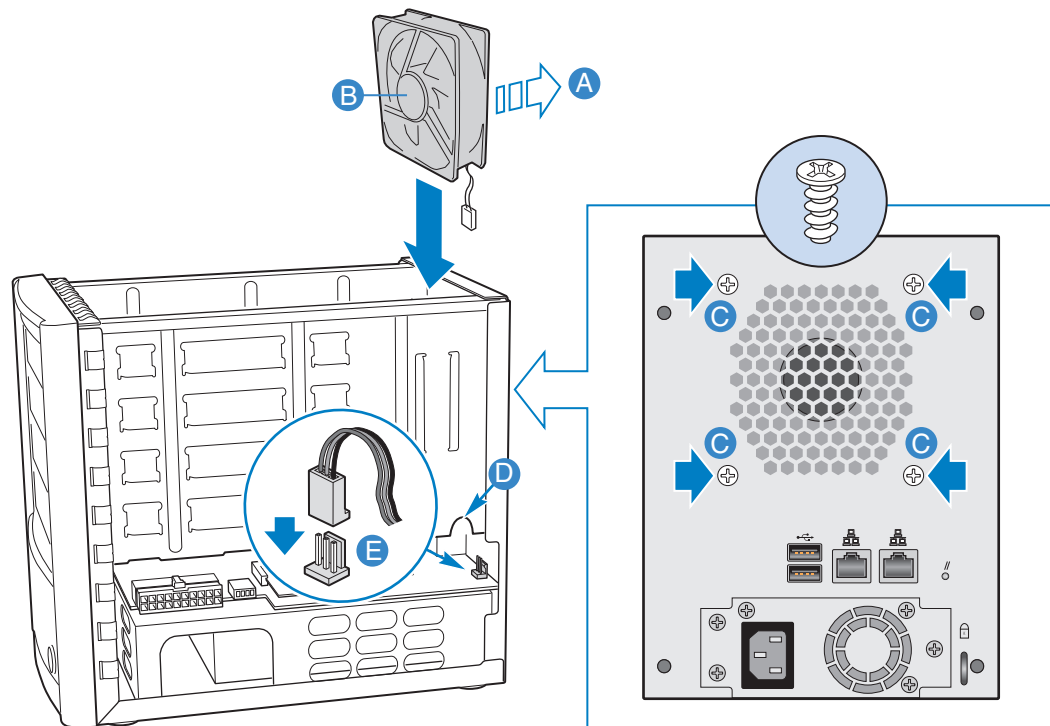

AF000298

**Figure 34. Installing New System Fan**

- Slide the backplane assembly into the guides on each side of the chassis. See letter “A” in the following figure. Ensure that the backplane assembly fully connects to its connector on the system board. See letter “B”. Secure the backplane assembly to the chassis with four screws, two per side. See letter “C”.

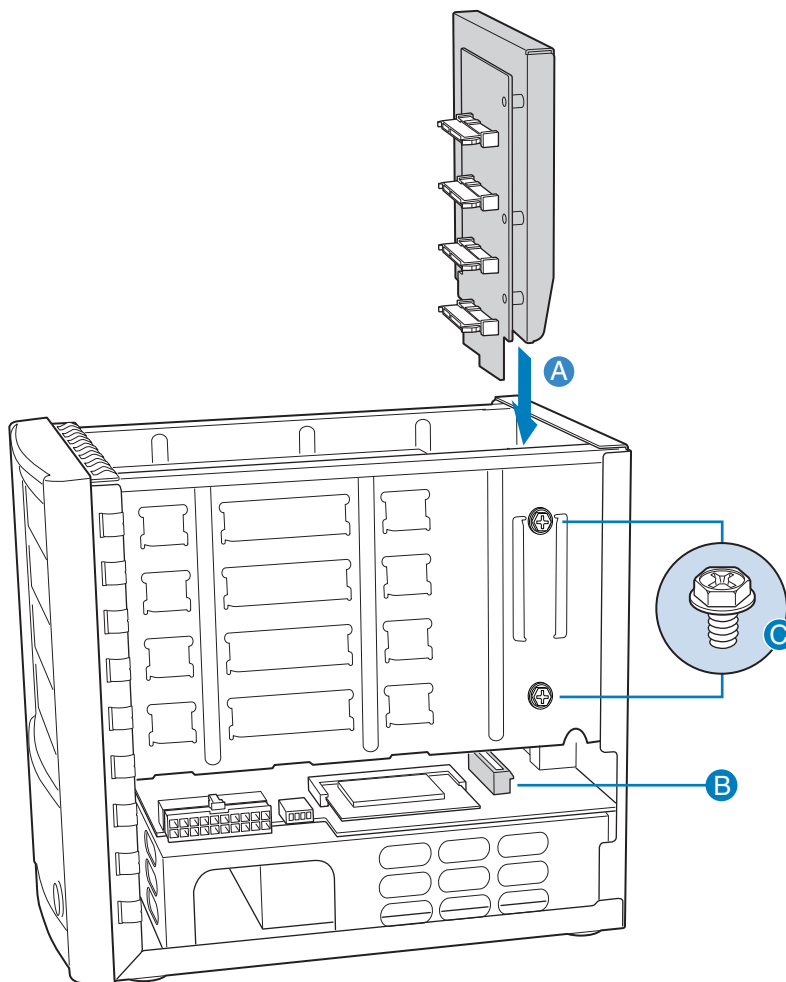

AF000299

**Figure 35. Re-installing Backplane Assembly**

11. Re-install the four drive carriers into the chassis making sure to re-install each drive carrier into its original slot.

**Note:** Ensure that each drive carrier is re-installed in its proper location.

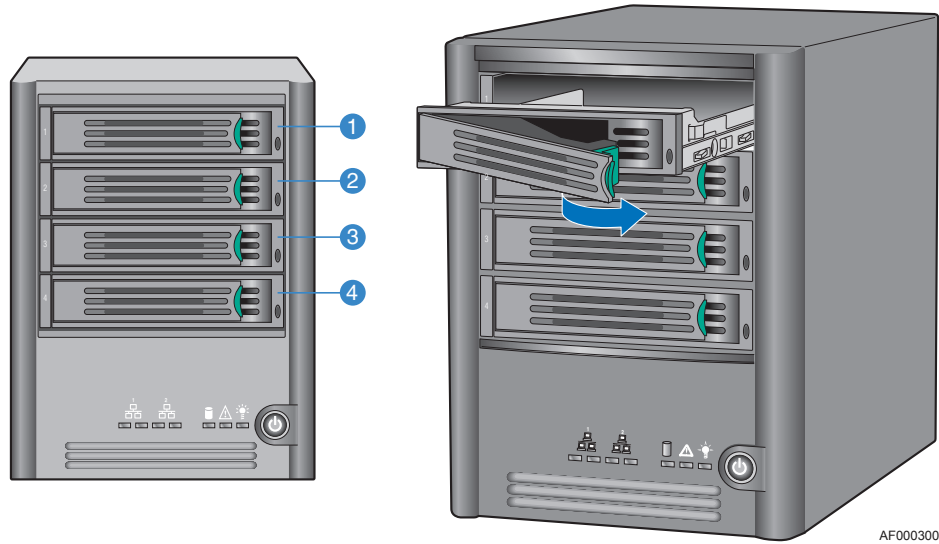

**Figure 36. Re-installing Drive Carriers**

- Align the guide on the left and right sides of the enclosure cover with the edge at the bottom of the chassis and slide the enclosure cover downward. See letter “A” in the following figure. Secure the enclosure cover to the chassis with four screws. See letter “B”.

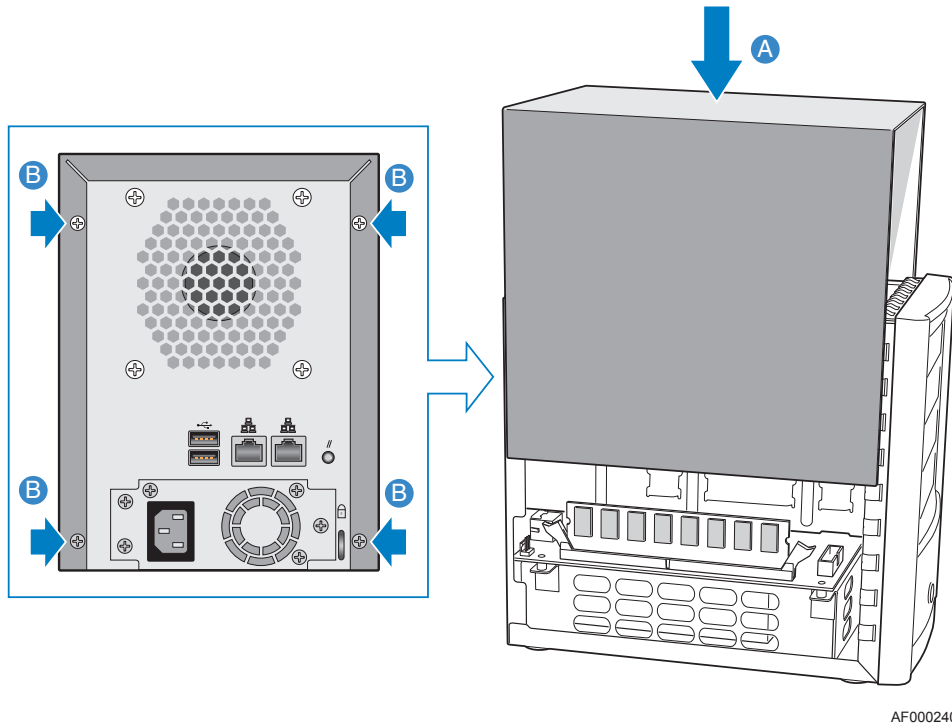

**Figure 37. Installing Enclosure Cover**

- Reconnect the storage system to its power source.
- Power up the storage system by pressing the power button on the front of the unit. The System Status LED flashes while the system is booting up.

# 8 Troubleshooting

## Viewing the System Log

The **System Log** page displays a list of events that have occurred on the storage system. Reviewing this list can help you identify and resolve any problems that you might encounter.

### Advanced : System Log

This list displays major system events. You can click Refresh to update it.

Date/Time	Type	Event
Jul 13 16:24:02	I	Group [Group1] changed (user [User3] added).
Jul 13 16:24:01	I	Group [Group1] changed (user [User2] added).
Jul 13 16:23:59	I	Group [Group1 ] added.
Jul 13 16:23:30	I	Shared folder [public] now available to [User3 ].
Jul 13 16:23:29	I	User [User3 ] added.
Jul 13 16:23:06	I	Shared folder [public] now available to [User2 ].
Jul 13 16:23:05	I	User [User2 ] added.
Jul 13 16:22:45	I	Shared folder [public] now available to [User1 ].
Jul 13 16:22:44	I	User [User1 ] added.

I=Informational, E=Error, W=Warning, C=Critical Error

Refresh

To view event information:

1. In the navigation bar, click **Advanced**.
2. In the left pane, click **System Log**.

The **System Log** page displays the date and time of the event, the type of event, and a brief description of the event.

- **I** = Informational
- **E** = Error
- **W** = Warning
- **C** = Critical

3. If an event occurs while you are viewing this list, click **Refresh** to update it.

## Troubleshooting the Storage System

This section provides general information about common problems that you might have with your storage system and steps you can take to resolve them.

### I Can't Access the Manager.

This can occur if you attached the network cable after powering on the storage system. Shut down the storage system, make sure the network cable is attached, and power it on again.

If you are using the Console, make sure the computer where the Console is installed is in the same subnet as the storage system.

If you are using a Web browser, make sure the name or IP address of the storage system is correct. You can use the storage system name only if your computer is in the same subnet as the storage system, if you added the storage system's IP address and name to your local **hosts** file, or if you manually registered the name with a DNS server in your network. In addition, if you configured the storage system to use a specific IP address, you might need to specify the IP address of the gateway in your network before you can successfully access the Manager using a Web browser. First access the Manager using the Console, as described in [“Logging in to the Manager” on page 27](#), and then specify the gateway address, as described in [“Changing the Network Settings” on page 68](#) and try to access it using a Web browser.

### I Forgot the Password for Logging in to the Manager.

You can reset the storage system to use its original administrator user name (**admin**) and password (**storage**) by pressing the small, recessed reset button on the back of the storage system.

**Note:** *This also resets the storage system to its original network settings. If you previously configured the storage system to use a specific IP address, it obtains its IP address from the DHCP server, if any. If you do not have a DHCP server on the network, it uses its default IP address (192.168.0.101). For information about changing these settings, see [“Changing the Network Settings” on page 68](#).*

*In addition, pressing this button restarts the storage system, which might adversely affect user connections to shared folders. Be sure to do this only when users are not connected to shared folders or performing recovery.*



## Users Can't Access the Shared Folders.

- Make sure the storage system is powered on, connected to the network, and operating properly.
- If the storage system uses local authentication mode, make sure the user configuration is correct. For Windows or Mac OS X users, try changing the password, as described in [“Modifying Users” on page 41](#), and accessing the shared folder again. For Linux users, make sure the computer name or IP address is correct. If it's not, recreate the user by removing the existing user, as described in [“Removing Users” on page 43](#), and adding it again as described in [“Adding Users” on page 32](#).

If the storage system uses Active Directory authentication mode, check the user configuration on the Active Directory server.

- If the storage system uses Active Directory authentication mode, make sure the clocks of the storage system and the Active Directory server do not differ by more than five minutes. If they do, errors will occur when users try to access the shared folders. It is recommended that you configure both the storage system and the Active Directory server to set their times from a common Network Time Protocol (NTP) server. To configure this on the storage system, see [“Changing the System Settings” on page 66](#).
- Make sure the users are using the proper procedure for accessing the shared folders, as described in [“Accessing Shared Folders” on page 79](#), including the correct name or IP address of the storage system. Windows\* and Mac OS X users can use the storage system name only if their computer is in the same subnet as the storage system, if they added the storage system's IP address and name to their local **hosts** file, or if the storage system name was manually registered with a DNS server in your network. Linux users must use the IP address.

Windows users can't access shared folders using the Console unless their computers are on the same subnet as the storage system. If using the Console does not work, try accessing the shared folders using My Computer/Windows Explorer as described in [“Using My Computer/Windows Explorer” on page 80](#)).

- Make sure the user's computer is connected to the network and can otherwise access the storage system.

To check the network connection in a Windows environment, click **Start > Run** and type `cmd`. At the command prompt, type the following:

```
ping IP_address
```

where `IP_address` is the IP address of the storage system. If you do not see `Reply from...`, the problem is with your network.

## Users Cannot Create Files in the Shared Folders.

- Check the access rights for the user as described in [“Assigning Users to Shared Folders” on page 56](#). The user must have read/write rights to be able to create files in the shared folder.
- There might not be enough space allocated to the shared folders. Expand the amount of available disk space as described in [“Expanding the Shared Storage” on page 72](#).

### The storage system is not distributing IP addresses.

Make sure that **Enable DHCP server** is selected on the **Network** page, as described in “[Changing the Network Settings](#)” on page 68, and that the starting and ending IP addresses are valid. The first three digit groups of both the starting IP address and ending IP address must be the same.

If the network configuration is correct and it still doesn't work, the DHCP service might not be working properly. Restart the storage system.

### The users cannot access the storage system using FTP.

Make sure that **Enable FTP server** is selected on the **Network** page, as described in “[Changing the Network Settings](#)” on page 68, and that the users are using the correct address for accessing the storage system as described in “[Reconfiguring Your Storage System Disks](#)” on page 71).

If the network configuration is correct and the users are using the proper address and it still doesn't work, the FTP service might not be working properly. Restart the storage system.

### A package size error appears when I upgrade the firmware

If you downloaded the firmware from a website or copied it from a CD, compare the original size of the package file with the size of the package file that you are using. If they differ, download or copy the file again to ensure that it is not corrupted.

If the problem persists, restart the storage system before upgrading the firmware. This ensures that any temporary files on the storage system are deleted before the firmware is upgraded.

## Troubleshooting Intel® Client Backup and Recovery

This section provides general information about common problems that you might have with Intel® Client Backup and Recovery and steps you can take to resolve them.

**Note:** *If you need help from Technical Support, you might be asked to create a diagnostic file. For information about this procedure, see “[Creating a Diagnostic File](#)” on page 165.*

### The disk that I want to protect isn't listed.

Intel® Client Backup and Recovery does not support dynamic disks. These disks are filtered from the list of disks that you can protect.

## Errors occur when I try to protect a disk.

- When adding a storage system to the list of backup locations, make sure that you are using the correct name or IP address of the storage system.
- If the storage system is already listed, select it in the list of backup locations and then click **Remove**. Then click **Add** to add it again. This resets the settings in the Microsoft iSCSI Initiator\* which might cause authentication problems.
- Make sure the storage system is powered on.
- Make sure the computer is connected to the network and can otherwise access the storage system.  
To check the network connection, click **Start** > **Run** and type `cmd`. At the command prompt, type the following:  
`ping IP_address`  
where `IP_address` is the IP address of the storage system. If you do not see `Reply from...`, the problem is with your network.
- Make sure that sufficient space is available on the storage system. At least an additional 20% of the disk size is required for changed data. For example, if the disk that you want to protect is 15 GB, at least 18 GB of space must be available on the storage system. The **Home** page in the Manager described in [“Viewing Information About Your Storage System” on page 30](#) displays the amount of available space.

**Note:** *If errors occur when you are protecting a disk for the first time, invalid backups might be created on the storage system. To ensure that you do not use up disk space unnecessarily, be sure to delete any extraneous backups on the storage system, as described in [“Deleting a Backup” on page 60](#). Compare the **Backup disk ID** on the **Status** page in Intel® Client Backup and Recovery with the **Backup Disk ID** on the **Backups** page in the Manager to determine which backup is actually being used.*

## The Status page indicates that the backup is offline.

- Make sure the storage system is powered on.
- Check the network connection to the storage system.  
To do this, click **Start** > **Run** and type `cmd`. At the command prompt, type the following:  
`ping IP_address`  
where `IP_address` is the IP address of the storage system. If you do not see `Reply from...`, the problem is with your network.
- Click **Action** > **Repair Connection** to refresh the network connection.
- Make sure that the backup has not been deleted on the storage system by checking the **Backups** page as described in [“Managing Backups” on page 58](#).  
If it has been deleted, remove protection as described in [“Removing Protection” on page 126](#) and protect the disk again as described in [“Protecting Your Disks” on page 98](#).
- If you changed the name of your computer, the storage system does not recognize it. Remove protection from your disks or partitions, as described in [“Removing](#)

[Protection](#) on page 126, delete the old computer name from the storage system, as described in [“Deleting a Client”](#) on page 61, and then protect your disks again as described in [“Protecting Your Disks”](#) on page 98.

### A backup did not occur at its scheduled time.

- Check the schedule as described in [“Changing the Backup Schedule”](#) on page 107 to confirm that it is correctly configured.
- Make sure the computer is powered on during the scheduled backup time.
- Make sure the storage system is powered on during the scheduled backup time.
- On the **Status** page, make sure that the **Status** is **Normal**. If protection is stopped, such as if you recovered the disk or recovered a different partition on the same disk, backups do not occur until you resume protection by clicking **Back Up Now**.  
If the **Status** is **Offline**, review the troubleshooting procedures in the preceding section.
- If you changed the name of your computer, the storage system does not recognize it any longer. Remove protection for all your disks or partitions, as described in [“Removing Protection”](#) on page 126, delete the old computer name from the storage system, as described in [“Deleting a Client”](#) on page 61, and then protect your disks again as described in [“Protecting Your Disks”](#) on page 98.
- If the IP address of the storage system changed, such as if the storage system obtains its IP address from a DHCP server and acquired a new one after you added the storage system to the list of backup locations, you must start Intel<sup>®</sup> Client Backup and Recovery so that it can retrieve the new IP address. You must do this each time the IP address on the storage system changes.

### I can't change my backup schedule.

On the **Status** page, make sure that the **Status** is **Normal**. If protection is stopped, such as if you recovered the disk or recovered a different partition on the same disk, you cannot change the schedule until you resume protection by clicking **Back Up Now**.

### I forgot my recovery password.

Reset the password using the storage system as described in [“Managing Backups”](#) on page 58. Once you reset it on the storage system, you can use the new password with the recovery CD or for booting remotely from the storage system.

## Creating a Diagnostic File

In some cases, you might need assistance from Technical Support to solve problems that you might have with Client Backup and Recovery. When you contact the Technical Support team, they might ask you to create a diagnostic file to help them better understand your environment and configuration settings.

You can create a diagnostic file using either the Intel® Client Backup and Recovery application or, in the event of a system failure, using the recovery CD. To create a diagnostic file using the recovery CD, the computer must have a floppy disk drive or a directly connected USB disk.

***Note:** This diagnostic file does not include the log files associated with the Intelligent Management Agent (IMA). You might be asked to send those files (iscmlib.log and iscm.service.log) separately.*

## Using Intel® Client Backup and Recovery

To create a diagnostic file using Intel® Client Backup and Recovery:

1. Run Intel® Client Backup and Recovery as described in “Starting Intel® Client Backup and Recovery” on page 95.
2. From the **Action** menu, click **Create Diagnostic File**.
3. Click **Save** to save the file using the default file name, or type the desired file name in the **File name** text box and then click **Save**. If desired, you can save the file in a different location.

Once the file has been created, you can send it to Technical Support.

## Using the Recovery CD

To create a diagnostic file using the recovery CD:

1. Insert the recovery CD into the computer’s CD-ROM drive.
2. After the CD has initialized, press Alt+F2.
3. At the command line, enter the following command and then press Enter:

```
xray
```

4. When prompted, enter your e-mail address and press Enter.

This ensures that your e-mail address is saved as part of the diagnostic file in case Technical Support needs to contact you.

5. When prompted, insert a formatted floppy disk into the computer’s floppy disk drive or attach a USB disk and press Enter.
6. When the list of destination options appears, enter the appropriate number and press Enter.

When a message appears, indicating that the file has been created, you can send it to Technical Support.

7. To return to the recovery CD menu, press Alt+F1.

For information about using the recovery CD to restore data, see [“Removing Protection” on page 126](#).

## Resetting the Recovery Password in the Microsoft iSCSI Initiator\*

The recovery password used by the recovery CD and for booting remotely is actually the Microsoft iSCSI Initiator\* CHAP secret. When you protect a disk or change the recovery password using Intel<sup>®</sup> Client Backup and Recovery, the Microsoft iSCSI Initiator\* is configured automatically.

If you forget this password, you can reset it on the storage system. However, if you do this when your system is down, that is, while you are booting from the recovery CD or booting remotely, the recovery password in your Microsoft iSCSI Initiator\* does not match the recovery password on the storage system. As a result, when you recover your system disk using the recovery CD and then boot from the local disk, you cannot connect to the storage system. Likewise, when you boot remotely, you cannot recover your disks.

This problem can also occur if you change the recovery password between backups using Intel<sup>®</sup> Client Backup and Recovery and then remotely boot from one of the earlier backups. In this case as well, the recovery password in the Microsoft iSCSI Initiator\* does not match the recovery password on the storage system.

To address this issue, you must reconfigure the Microsoft iSCSI Initiator\* to use the password that you specified on the storage system. If you are using the recovery CD, you must do this after you recover your system disk. If you are booting remotely, you must do this while in **Network Boot Mode**, before you recover your system disk, and again after you recover your disk and boot locally.

To reset the recovery password in the Microsoft iSCSI Initiator\*:

1. Click **Start > Programs > Microsoft iSCSI Initiator > Microsoft iSCSI Initiator**.
2. Click the **Targets** tab.
3. If more than one target appears in the **Targets** list, select the one that contains the name of the storage system.

The **Status** should be **Disconnected**.

4. Click **Log On**.
5. Click **Advanced**.
6. Select the **CHAP logon information** check box.
7. In the **User name** text box, type your computer name in all capital letters.
8. In the **Target secret** text box, type the recovery password that you specified on the storage system.
9. Click **OK** on the Advanced Settings and Log On to Target dialog boxes.

The **Status** of the target should now be **Connected**.

10. Click **OK** on the iSCSI Initiator Properties dialog box.

# 9 Technical Specifications

See the Intel® Entry Storage System SS4000-E *Technical Product Specification* at <http://support.intel.com/support/motherboards/server/ss4000-E/> for additional technical specification information.

## Hardware Specification

**Table 5. Hardware Specifications**

Component	Specification
Processor	400-MHz Intel® IOP80219
Memory	256 MB 32-bit DDR SDRAM
Flash	32-MB NOR Flash
Hard Drive	Supports up to four 3.5-in SATA-I hard drives from 80 GB <b>NOTE:</b> The total amount of storage space cannot exceed 3 terabytes.
Maximum Capacity	Up to 3 terabytes
Network	Two Intel® gigabit LAN port interface
USB	Two USB 2.0 connectors
EMI Safety	CE/FCC Class B
System Power	200-W power supply
Operating Temperature	10° C to 35° C (50° F to 95° F)

**Note:** *If the temperature of the processor reaches or exceeds 85° C (185° F) or if the temperature of any of the backplane temperature sensors reaches or exceeds 55° C (131° F), the storage system shuts down automatically.*

*If the temperature of any of the backplane temperature sensors reaches or exceeds 42° C (107.6° F), the fan runs at full speed. If, subsequently, the temperature of any of the backplane temperature sensors reaches or falls below 37° C (98.6° F), the fan returns to normal speed.*

## Software Specification

**Table 6. Software Component Specifications**

Component	Specification
Operating System	Linux Kernel 2.6.10
Network Service	DHCP client/server (default IP address for Port 1 is 192.168.0.101)
Supported Web Browsers	<ul style="list-style-type: none"> <li>• Microsoft Internet Explorer 6.0*</li> <li>• Firefox* 1.06 or newer</li> </ul>
RAID	<ul style="list-style-type: none"> <li>• Standard RAID 0</li> <li>• RAID 1</li> <li>• RAID 5</li> <li>• RAID 5 + spare</li> <li>• RAID 10</li> </ul>
File Sharing Protocols	<ul style="list-style-type: none"> <li>• CIFS/SMB</li> <li>• NFS</li> </ul>
Access Control	<ul style="list-style-type: none"> <li>• Users have read-only or read/write access to shared folders</li> <li>• CIFS users access shared folders using passwords</li> </ul>



# A Levels of RAID

---

**Caution:** After you initially configure your storage system, you can change from one type of disk configuration to another as described in “Reconfiguring Your Storage System Disks” on page 71. Doing this deletes all the data on your storage system.

## Linear

**Caution:** A linear disk configuration does not offer any data protection. If you lose a hard disk, data loss occurs.

A linear configuration is similar to using multiple hard disks in a regular computer. Each disk is an independent entity, and the data on it is self-contained. You can add or remove the disks without affecting the other disks. All the available disk space is used for data.

If your storage system has only one disk, you must use a linear configuration. However, you can use a linear configuration for two, three, or four disks as well.

## RAID 0 - Data Striping

**Caution:** A RAID 0 disk configuration does not offer any data protection. If you lose a hard disk, data loss occurs.

Instead of writing all the data to one disk in a linear fashion, some bytes are written to one disk, and other bytes are written to another. Performance is faster because reading and writing activities can occur on multiple disks simultaneously. All the available disk space is used for data.

For RAID 0, your storage system must have at least two disks. However, you can use RAID 0 with three or four disks as well, and the disks can be any size.

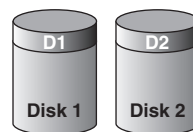

AF000242

**Figure 38. RAID 0 - Data Striping**

## RAID 1 - Disk Mirroring/Disk Duplexing

In a RAID 1 configuration, all the data written to one disk is duplicated on the other disk. This offers greater data protection since if one disk fails, all your data is still intact on the other disk. However, using RAID 1 means only half your available disk space is used for data; the other half is used for a duplicate (mirror) of that data.

You can use RAID 1 only if your storage system has only two disks. If the disks are not the same size, the smaller of the two disks is used for data, and the larger of the two disks is used as the mirror.

If one disk fails, the other disk continues to make its data available.

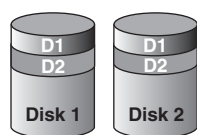

AF000243

**Figure 39. RAID 1 - Disk Mirroring/Disk Duplexing**

## RAID 5 - Data Striping with Striped Parity

Like RAID 0, RAID 5 offers increased performance by distributing the data across multiple disks. But unlike RAID 0, RAID 5 also offers data protection. If your storage system has three disks of equal size, two thirds of each disk are used for data, and the remaining third contains the parity information needed to reconstruct either of the other two. In this way, if any of the three disks fails, it can be reconstructed when a new disk is installed in the storage system.

If your storage system has four disks of equal size, three fourths of each disk are used for data, and the remaining fourth contains the parity information needed to reconstruct either of the other three. If any of the four disks fails, it can be reconstructed when a new disk is installed.

You can use RAID 5 only if your storage system has at least three disks. If the disks are not the same size, the smallest of the disks determines how much disk space is available for data. For example, if one disk is 300 GB, one is 400 GB, and one is 500 GB, only 300 GB from each disk can be used. Two thirds of each disk (200 GB) is used for storage space, and the remaining third is used for parity information. As a result, only 600 GB of disk space would be available for data.

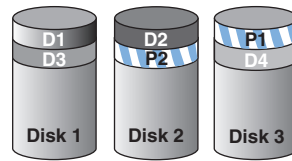

AF000289

**Figure 40. RAID 5 - Data Striping with Striped Parity**

## RAID 5 + Spare

In a RAID 5 + spare configuration, three of the disks use RAID 5, and the fourth is empty. If any of the three disks fails, it is immediately rebuilt using the fourth spare disk. As a result, you can remove the failed disk and still have the ongoing fast performance and data protection offered by RAID 5. When the failed disk is repaired or replaced and re-installed into the storage system, it automatically becomes the spare for the other functioning three.

You can use RAID 5 + spare only if your storage system has four disks. If the disks are not the same size, the smallest of the disks determines how much disk space is available for data, similar to RAID 5.

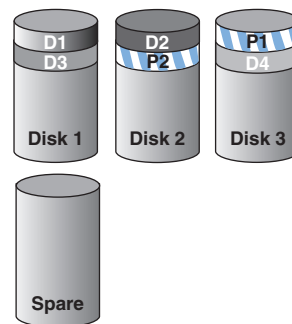

AF000291

**Figure 41. RAID 5 + Spare**

## RAID 10 - Combination of RAID 1 and RAID 0

RAID 10 is similar to RAID 1, but rather than having one disk mirror to one other disk, two disks mirror to the two other disks.

You can use RAID 10 only if your storage system has four disks. The disks in the first two slots constitute the first pair, and the disks in the second two slots constitute the second pair. In each pair, the smaller of the two disks is used for data, and the larger of the two disks is used as the mirror.

If one disk in the pair fails, the other disk continues to make its data available.

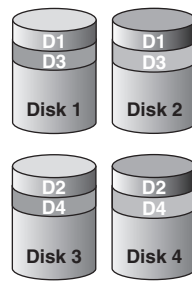

AF000290

**Figure 42. RAID 10 - Combination of RAID 1 and RAID 0**

## B PXE Remote Boot

---

If you cannot boot from the operating system on the computer connected to the storage appliance, you can boot over the network using PXE boot.

PXE is an acronym for Pre-boot eXecution Environment. By following this procedure, your computer can be remotely booted by the storage system. Follow the steps below to remotely boot from the Intel® Entry Storage System SS4000-E.

1. Power off your computer.
2. Wait a few minutes and power the computer back on. The screen displays two options: **Normal Boot** and **Remote Boot**.
3. Use the down arrow key to highlight **Remote Boot** and press Enter. PXE initializes and asks for the remote boot password.
4. Type the same password you created when setting up Client Backup and Recovery and press **Enter**.

Your computer boots remotely from the Intel Entry Storage System SS4000E. The upper portion of the screen that displays indicates you are in Network Boot Mode. Once you are in the mode you can repair the original boot sector on your hard drive.

The Windows screen displays once booted from the system partition on the storage system. The upper portion of the screen indicates you are in Network Boot Mode. Once in this mode, you can repair the original boot sector on your c: drive

**Note:** *Any modifications made to the PXE disk during the boot will be discarded. The PXE disk is only a timeview disk. The iSCSI disk is the actual mirror disk. If data is changed on the iSCSI disk during the PXE boot, it will remain intact*

In the example below, Drive C: is the PXE boot disk. Drive E: is the original local system disk and disk2 is the iSCSI disk. If the original system disk is not connected, Drive C: is the boot and system disk.

There are three copies of the operating system disk in a PXE session. The original physical disk, the remote boot disk from the Baxter Creek appliance and the base disk from the Baxter Creek appliance provided by the Microsoft iSCSI Initiator.

## PXE Remote Boot

If you unplug the original physical disk before a PXE boot, the PXE disk will be the system and boot partition. When the original physical disk is still fully connected, the system disk will be on the original local disk because Windows remembers its disk signatures illustrated in the following example.

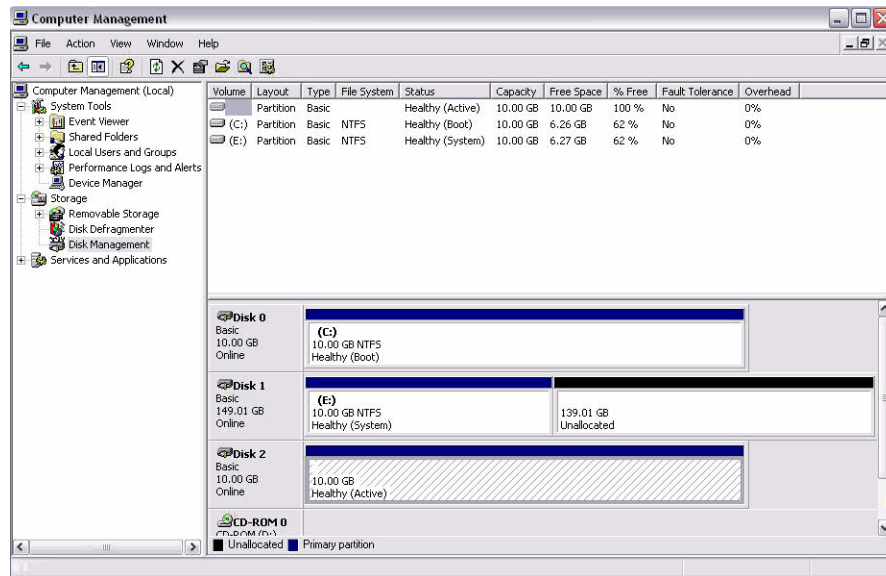

**Note:** The simplest way to identify the PXE disk is to remember its drive letter. For example; If your original system drive was C:, the disk identified as C: during the PXE boot is the PXE boot disk.

## C Glossary

---

- backup view** A backup that has been assigned a drive letter and can be opened and explored using My Computer/Windows Explorer
- Console** The Windows-based application that enables you to discover all the storage systems on your subnet, view their version and network information, access the Manager, and map drive letters to shared folders
- data disk or partition** A hard disk or partition of a hard disk that is not used to run the computer operating system
- group** A collection of one or more users that can be given access to a shared folder all at once
- jumbo frame** A large packet size for transferring data between the storage system and computers in the network
- Manager** The Web-based user interface that enables you to configure the storage system
- NIC** An acronym for network interface card
- NTP** An acronym for Network Time Protocol, a mechanism for synchronizing a computer's time with a standard time on a server
- RAID** An acronym for redundant array of independent disks
- Different levels of RAID provide different types of data protection and data duplication, as well as enhance the performance of your disks.
- remote boot** The process of booting your computer from the storage system rather than from a local hard disk
- shared folder** A folder on the storage system that can be accessed by authorized users
- subnet** A portion of a local area network
- Computers in a subnet typically have IP addresses that are the same except for the last three digits. For example, computers with IP addresses of 192.168.0.101, 192.168.0.102, and 192.168.0.103 would all belong to the same subnet.

## *Glossary*

**system disk or partition** A hard disk or partition of a hard disk that the computer boots from

**user** An individual or computer that can access a shared folder on the storage system



# D Regulatory and Compliance Information

---

## Product Regulatory Compliance

**Warning:** *To ensure regulatory compliance, you must adhere to the assembly instructions in this guide to ensure and maintain compliance with existing product certifications and approvals. Use only the described, regulated components specified in this guide. Use of other products/components voids the UL listing and other regulatory approvals of the product and most likely results in noncompliance with product regulations in the region(s) in which the product is sold.*

*To help ensure EMC compliance with your local regional rules and regulations, before performing integration, make sure the peripheral devices selected have passed EMC testing. The final configuration of your end system product may require additional EMC compliance testing. For more information, please contact your local Intel representative.*

*This is an FCC Class B device.*

## Intended Application

This product was evaluated as Information Technology Equipment (ITE), which may be installed in homes, offices, schools, computer rooms, and similar commercial type locations. The suitability of this product for other product categories and environments (such as: medical, industrial, telecommunications, NEBS, residential, alarm systems, test equipment, etc.), other than an ITE application, may require further evaluation.

## Product Safety Compliance

This product complies with the following product safety requirements:

- UL60950 - CSA 60950 (USA / Canada)
- EN60950 (Europe)
- IEC60950 (International)
- CB Certificate & Report, IEC60950 (report to include all country national deviations)
- GS License (Germany)
- GOST R 50377-92 - License (Russia)
- Belarus License (Belarus)
- Ukraine License (Ukraine)
- CE - Low Voltage Directive 73/23/EEE (Europe)
- IRAM Certification (Argentina)

## Product EMC Compliance - Class B Compliance

This is an FCC Class B device.

- FCC /ICES-003 - Emissions (USA/Canada)
- CISPR 22 - Emissions (International)
- EN55022 - Emissions (Europe)
- EN55024 - Immunity (Europe)
- EN61000-3-2 - Harmonics (Europe)
- EN61000-3-3 - Voltage Flicker (Europe)
- CE - EMC Directive 89/336/EEC (Europe)
- VCCI Emissions (Japan)
- AS/NZS 3548 Emissions (Australia / New Zealand)
- BSMI CNS13438 Emissions (Taiwan)
- GOST R 29216-91 Emissions (Russia)
- GOST R 50628-95 Immunity (Russia)
- Belarus License (Belarus)
- Ukraine License (Ukraine)
- RRL MIC Notice No. 1997-41 (EMC) & 1997-42 (EMI) (Korea)







## Certifications / Registrations / Declarations

- UL Certification (US/Canada)
- CE Declaration of Conformity (CENELEC Europe)
- FCC/ICES-003 Class A Attestation (USA/Canada)
- VCCI Certification (Japan)
- C-Tick Declaration of Conformity (Australia)
- MED Declaration of Conformity (New Zealand)
- BSMI Certification (Taiwan)
- GOST R Certification / License (Russia)
- Belarus Certification / License (Belarus)
- RRL Certification (Korea)
- IRAM Certification (Argentina)
- Ecology Declaration (International)

## Product Regulatory Compliance Markings

This product bears the following regulatory marks.

**Table 7. Product Regulatory Compliance Markings**

Regulatory Compliance	Country	Marking
cULus Listing Marks	USA/Canada	
GS Mark	Germany	
CE Mark	Europe	
FCC Marking (Class B)	USA	
EMC Marking (Class B)	Canada	<b>CANADA ICES-003 CLASS B</b> <b>CANADA NMB-003 CLASSE B</b>
C-Tick Mark	Australia/New Zealand	
VCCI Marking (Class B)	Japan	
BSMI Certification Number & Class B Warning	Taiwan	
GOST R Marking	Russia	
RRL MIC Mark	Korea	

## Electromagnetic Compatibility Notices

### FCC Statement (USA)

This device complies with Part 15 of the FCC Rules. Operation is subject to the following two conditions: (1) this device may not cause harmful interference, and (2) this device must accept any interference received, including interference that may cause undesired operation.

Intel Corporation  
5200 N.E. Elam Young Parkway  
Hillsboro, OR 97124-6497  
1-800-628-8686

This equipment has been tested and found to comply with the limits for a Class B digital device, pursuant to Part 15 of the FCC Rules. These limits are designed to provide reasonable protection against harmful interference in a residential installation. This equipment generates, uses, and can radiate radio frequency energy and, if not installed and used in accordance with the instructions, may cause harmful interference to radio communications. However, there is no guarantee that interference does not occur in a particular installation. If this equipment does cause harmful interference to radio or television reception, which can be determined by turning the equipment off and on, the user is encouraged to try to correct the interference by one or more of the following measures:

- Reorient or relocate the receiving antenna.
- Increase the separation between the equipment and the receiver.
- Connect the equipment to an outlet on a circuit other than the one to which the receiver is connected.
- Consult the dealer or an experienced radio/TV technician for help.

Any changes or modifications not expressly approved by the grantee of this device can void the user's authority to operate the equipment. The customer is responsible for ensuring compliance of the modified product.

Only peripherals (computer input/output devices, terminals, etc.) that comply with FCC Class B limits may be attached to this computer product. Operation with noncompliant peripherals is likely to result in interference to radio and TV reception.

All cables used to connect to peripherals must be shielded and grounded. Operation with cables, connected to peripherals, that are not shielded and grounded may result in interference to radio and TV reception.

### ICES-003 (Canada)

Cet appareil numérique respecte les limites bruits radioélectriques applicables aux appareils numériques de Classe B prescrites dans la norme sur le matériel brouilleur: "Appareils Numériques", NMB-003 édictée par le Ministre Canadien des Communications.

English translation of the notice above:

This digital apparatus does not exceed the Class B limits for radio noise emissions from digital apparatus set out in the interference-causing equipment standard entitled: “Digital Apparatus,” ICES-003 of the Canadian Department of Communications.

## Europe (CE Declaration of Conformity)

This product has been tested in accordance to, and complies with the Low Voltage Directive (73/23/EEC) and EMC Directive (89/336/EEC). The product has been marked with the CE Mark to illustrate its compliance.

## VCCI (Japan)

この装置は、情報処理装置等電波障害自主規制協議会（VCCI）の基準に基づくクラスB情報技術装置です。この装置は、家庭環境で使用することを目的としていますが、この装置がラジオやテレビジョン受信機に近接して使用されると、受信障害を引き起こすことがあります。  
取扱説明書に従って正しい取り扱いをして下さい。

## BSMI (Taiwan)

**警告使用者：**  
這是甲類的資訊產品，在居住的環境中使用時，可能會造成射頻干擾，在這種情況下，使用者會被要求採取某些適當的對策

The BSMI Certification Marking and EMC warning is located on the outside rear area of the product.

## RRL (Korea)

Following is the RRL certification information for Korea.



1. 기기의 명칭(모델명) :
2. 인증번호 :
3. 인증받은 자의 상호 :
4. 제조년월일 :
5. 제조자/제조국가 :

English translation of the notice above:

1. Type of Equipment (Model Name): On License and Product
2. Certification No.: On RRL certificate. Obtain certificate from local Intel representative

3. Name of Certification Recipient: Intel Corporation
4. Date of Manufacturer: see date code on product
5. Manufacturer/Nation: Intel Corporation/see country of origin marked on product

## End of Life / Product Recycling

Product recycling and end-of-life take-back systems and requirements vary from country to country. Contact the retailer or distributor of this product for information on product recycling and / or take back.

## Restriction of Hazardous Substances (RoHS) Compliance

Intel has a system in place to restrict the use of banned substances in accordance with the European Directive 2002/95/EC. Compliance is based on declaration that materials banned in the RoHS Directive are either (1) below all applicable substance threshold limits or (2) an approved/pending RoHS exemption applies.

**Note:** *RoHS implementing details are not fully defined and may change.*

Threshold limits and banned substances are noted below:

- Quantity limit of 0.1% by mass (1000 PPM) for:
  - Lead
  - Mercury
  - Hexavalent Chromium
  - Polybrominated Biphenyls Diphenyl Ethers (PBDE)
- Quantity limit of 0.01% by mass (100 PPM) for:
  - Cadmium

# E Warranty

---

## Limited Warranty for Intel® Chassis Subassembly Products

Intel warrants that the Products (defined herein as the Intel® chassis subassembly and all of its various components and software delivered with or as part of the Products) to be delivered hereunder, if properly used and installed, is free from defects in material and workmanship and substantially conforms to Intel's publicly available specifications for a period of three (3) years after the date the Product was purchased from an Intel authorized distributor. Software of any kind delivered with or as part of products is expressly provided “as is” unless specifically provided for otherwise in any software license accompanying the software.

If any Product furnished by Intel which is the subject of this Limited Warranty fails during the warranty period for reasons covered by this Limited Warranty, Intel, at its option, will:

- REPAIR the Product by means of hardware and/or software; OR
- REPLACE the Product with another Product; OR
- REFUND the then-current value of the Product if Intel is unable to repair or replace the Product.

If such Product is defective, transportation charges for the return of Product to buyer within the USA is paid by Intel. For all other locations, the warranty excludes all costs of shipping, customs clearance, and other related charges. Intel will have a reasonable time to make repairs or to replace Product or to refund the then-current value of the Product.

In no event will Intel be liable for any other costs associated with the replacement or repair of Product, including labor, installation or other costs incurred by buyer and in particular, any costs relating to the removal or replacement of any product soldered or otherwise permanently affixed to any printed circuit board.

This Limited Warranty, and any implied warranties that may exist under state law, apply only to the original purchaser of the Product.

## Extent of Limited Warranty

Intel does not warrant that Products to be delivered hereunder, whether delivered stand-alone or integrated with other Products, including without limitation semiconductor components, is free from design defects or errors known as “errata.” Current characterized errata are available upon request.

This Limited Warranty does not cover damages due to external causes, including accident, problems with electrical power, usage not in accordance with product instructions, misuse, neglect, alteration, repair, improper installation, or improper testing.

## Warranty Limitations and Exclusions

These warranties replace all other warranties, expressed or implied including, but not limited to, the implied warranties of merchantability and fitness for a particular purpose. Intel makes no expressed warranties beyond those stated here. Intel disclaims all other warranties, expressed or implied including, without limitation, implied warranties of merchantability and fitness for a particular purpose. Some jurisdictions do not allow the exclusion of implied warranties, so this limitation may not apply.

All expressed and implied warranties are limited in duration to the limited warranty period. No warranties apply after that period. Some jurisdictions do not allow limitations on how long an implied warranty lasts, so this limitation may not apply to you.

## Limitations of Liability

Intel's responsibility under this, or any other warranty, implied or expressed, is limited to repair, replacement, or refund, as set forth above. These remedies are the sole and exclusive remedies for any breach of warranty. Intel is not responsible for direct, special, incidental, or consequential damages resulting from any breach of warranty under another legal theory including, but not limited to, lost profits, downtime, goodwill, damage to or replacement of equipment and property, and any costs of recovering, reprogramming, or reproducing any program or data stored in or used with a system containing this product. Some jurisdictions do not allow the exclusion or limitation of incidental or consequential damages, so the above limitations or exclusions may not apply to you.

This limited warranty gives you specific legal rights, and you may also have other rights that vary from jurisdiction to jurisdiction.

Any and all disputes arising under or related to this Limited Warranty shall be adjudicated in the following forums and governed by the following laws: for the United States of America, Canada, North America, and South America, the forum shall be Santa Clara, California, USA, and the applicable law shall be that of the State of California, USA; for the Asia Pacific region, the forum shall be Singapore and the applicable law shall be that of Singapore; for Europe and the rest of the world, the forum shall be London and the applicable law shall be that of the United Kingdom.

In the event of any conflict between the English language version and any other translated version(s) of this Limited Warranty, the English language version shall control.

## How to Obtain Warranty Service

To obtain warranty service for this Product, you may contact Intel or your authorized distributor.

- North America and Latin America To obtain warranty repair for the product, please go to the following Web site to obtain instructions: <http://support.intel.com/support/motherboards/draform.htm>
- In Europe and in Asia Contact your original authorized distributor for warranty service.



Any replacement Product is warranted under this written warranty and is subject to the same limitations and exclusions for the remainder of the original warranty period.

## Telephone Support

If you cannot find the information you need on Intel's World Wide Web site (<http://www.intel.com/>), call your local distributor or an Intel Customer Support representative. See “[Getting Help](#)” for telephone numbers.

## Returning a Defective Product

Before returning any product, call your authorized dealer/distribution authority.

**This page intentionally left blank.**

# F Getting Help

---

## World Wide Web

<http://support.intel.com/support/motherboards/server/ss4000-e/>.

## Telephone

All calls are billed US \$25.00 per incident, levied in local currency at the applicable credit card exchange rate plus applicable taxes. (Intel reserves the right to change the pricing for telephone support at any time without notice).

For an updated support contact list, see <http://www.intel.com/support/9089.htm/>

## U.S. and Canada

1-800-404-2284

## Europe

**Belgium** ..... 02 714 3182

**Denmark** ... 38 487077

**Finland** ..... 9 693 79297

**France**..... 01 41 918529

**Germany** ... 069 9509 6099

**Holland**..... 020 487 4562

**Italy**..... 02 696 33276

**Norway** ..... 23 1620 50

**Spain**..... 91 377 8166

**Sweden**..... 08 445 1251

**UK**..... 870 6072439

## In Asia-Pacific region

**Australia**.... 1800 649931

**Cambodia**.. 63 2 636 9797 (via Philippines)

**China** ..... 800 820 1100 (toll-free)  
..... 8 621 33104691 (not toll-free)

**Hong Kong** 852 2 844 4456

**India**..... 0006517 2 68303634 (manual toll-free. You need an IDD-equipped telephone)

**Indonesia** ... 803 65 7249

**Korea** ..... 822 767 2595

**Malaysia** .... 1 800 80 1390

**Myanmar**... 63 2 636 9796 (via Philippines)

**New Zealand** 0800 444 365

**Pakistan**.... 632 63684 15 (IDD via Philippines)

**Philippines** 1 800 1 651 0117

**Singapore** .. 65 6213-1311

**Taiwan** ..... 2 2545-1640

**Thailand** .... 1 800 631 0003

**Vietnam** ..... 632 6368416 (IDD via Philippines)

## Japan

**Domestic**.... 0120 868686

**Outside country** 81 298 47 0800

## Latin America

**Argentina** .. Contact AT&T USA at 0-800 222 1288. Once connected, dial 800 843 4481

**Brazil** ..... 001-916 377 0180

**Chile**

**Easter Island.** ..... Contact AT&T USA at 800 800 311. Once connected, dial 800 843 4481

**Mainland and Juan** .. Contact AT&T USA at 800 225 288. Once connected, dial 800 843 4481

**Colombia**... Contact AT&T USA at 01 800 911 0010. Once connected, dial 800 843 4481

**Costa Rica** . Contact AT&T USA at 0 800 0 114 114. Once connected, dial 800 843 4481

**Ecuador**

**(Andimate)** .... Contact AT&T USA at 1 999 119. Once connected, dial 800 843 4481

**(Pacifictel)** ..... Contact AT&T USA at 1 800 225 528. Once connected, dial 800 843 4481

**Guatemala**. Contact AT&T USA at 99 99 190. Once connected, dial 800 843 4481

**Mexico** ..... Contact AT&T USA at 001 800 462 628 4240. Once connected, dial 800 843 4481

**Miami** ..... 1 800 621 8423

**Panama**..... Contact AT&T USA at 00 800 001 0109. Once connected, dial 800 843 4481

**Paraguay** ... 001 916 377 0114

**Peru** ..... 001 916 377 0114



**Uruguay**..... 001 916 377 0114

**Venezuela**... Contact AT&T USA at 0 800 2255 288. Once connected, dial 800 843 4481

**This page intentionally left blank.**

# G Installation/Assembly Safety Instructions

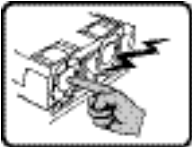
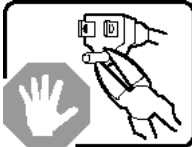
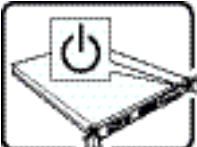

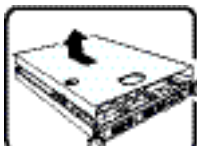
## English

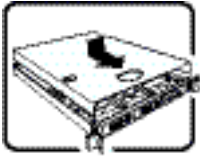
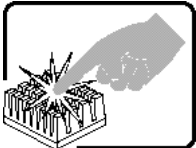
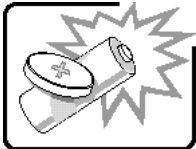
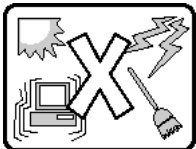
	<p>The power supply in this product contains no user-serviceable parts. Refer servicing only to qualified personnel.</p>
	<p>Do not attempt to modify or use the supplied AC power cord if it is not the exact type required. A product with more than one power supply has a separate AC power cord for each supply.</p>
	<p>The power button on the system does not turn off system AC power. To remove AC power from the system, you must unplug each AC power cord from the wall outlet or power supply.</p> <p>The power cord(s) is considered the disconnect device to the main (AC) power. The socket outlet that the system plugs into shall be installed near the equipment and shall be easily accessible.</p>
	<p><b>SAFETY STEPS:</b> Whenever you remove the chassis covers to access the inside of the system, follow these steps:</p> <ol style="list-style-type: none"> <li>1. Turn off all peripheral devices connected to the system.</li> <li>2. Turn off the system by pressing the power button.</li> <li>3. Unplug all AC power cords from the system or from wall outlets.</li> <li>4. Label and disconnect all cables connected to I/O connectors or ports on the back of the system.</li> <li>5. Provide some electrostatic discharge (ESD) protection by wearing an antistatic wrist strap attached to chassis ground of the system-any unpainted metal surface-when handling components.</li> <li>6. Do not operate the system with the chassis covers removed.</li> </ol>
	<p>After you have completed the six SAFETY steps above, you can remove the system covers. To do this:</p> <ol style="list-style-type: none"> <li>1. Unlock and remove the padlock from the back of the system if a padlock has been installed.</li> <li>2. Remove and save all screws from the covers.</li> <li>3. Remove the cover(s).</li> </ol>

	<p>For proper cooling and airflow, always reinstall the chassis covers before turning on the system. Operating the system without the covers in place can damage system parts. To install the covers:</p> <ol style="list-style-type: none"> <li>1. Check first to make sure you have not left loose tools or parts inside the system.</li> <li>2. Check that cables, add-in boards, and other components are properly installed.</li> <li>3. Attach the covers to the chassis with the screws removed earlier, and tighten them firmly.</li> <li>4. Insert and lock the padlock to the system to prevent unauthorized access inside the system.</li> <li>5. Connect all external cables and the AC power cord(s) to the system.</li> </ol>
	<p>A microprocessor and heat sink may be hot if the system has been running. Also, there may be sharp pins and edges on some board and chassis parts. Contact should be made with care. Consider wearing protective gloves.</p>
	<p>Danger of explosion if the battery is incorrectly replaced. Replace only with the same or equivalent type recommended by the equipment manufacturer. Dispose of used batteries according to manufacturer's instructions.</p>
	<p>The system is designed to operate in a typical office environment. Choose a site that is:</p> <ul style="list-style-type: none"> <li>• Clean and free of airborne particles (other than normal room dust).</li> <li>• Well ventilated and away from sources of heat including direct sunlight.</li> <li>• Away from sources of vibration or physical shock.</li> <li>• Isolated from strong electromagnetic fields produced by electrical devices.</li> <li>• In regions that are susceptible to electrical storms, we recommend you plug your system into a surge suppressor and disconnect telecommunication lines to your modem during an electrical storm.</li> <li>• Provided with a properly grounded wall outlet.</li> <li>• Provided with sufficient space to access the power supply cord(s), because they serve as the product's main power disconnect.</li> </ul>

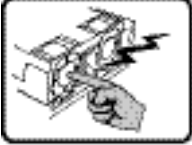
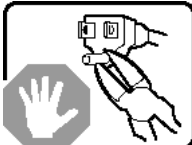
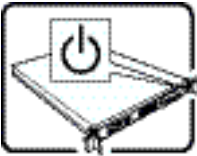

## Deutsch

	<p>Benutzer können am Netzgerät dieses Produkts keine Reparaturen vornehmen. Das Produkt enthält möglicherweise mehrere Netzgeräte. Wartungsarbeiten müssen von qualifizierten Technikern ausgeführt werden.</p>
	<p>Versuchen Sie nicht, das mitgelieferte Netzkabel zu ändern oder zu verwenden, wenn es sich nicht genau um den erforderlichen Typ handelt. Ein Produkt mit mehreren Netzgeräten hat für jedes Netzgerät ein eigenes Netzkabel.</p>
	<p>Der Wechselstrom des Systems wird durch den Ein-/Aus-Schalter für Gleichstrom nicht ausgeschaltet. Ziehen Sie jedes Wechselstrom-Netzkabel aus der Steckdose bzw. dem Netzgerät, um den Stromanschluß des Systems zu unterbrechen.</p>
	<p><b>SICHERHEISSMASSNAHMEN:</b> Immer wenn Sie die Gehäuseabdeckung abnehmen um an das Systeminnere zu gelangen, sollten Sie folgende Schritte beachten:</p> <ol style="list-style-type: none"> <li>1. Schalten Sie alle an Ihr System angeschlossenen Peripheriegeräte aus.</li> <li>2. Schalten Sie das System mit dem Hauptschalter aus.</li> <li>3. Ziehen Sie den Stromanschlußstecker Ihres Systems aus der Steckdose.</li> <li>4. Auf der Rückseite des Systems beschriften und ziehen Sie alle Anschlußkabel von den I/O Anschlüssen oder Ports ab.</li> <li>5. Tragen Sie ein geerdetes Antistatik Gelenkband, um elektrostatische Ladungen (ESD) über blanke Metallstellen bei der Handhabung der Komponenten zu vermeiden.</li> <li>6. Schalten Sie das System niemals ohne ordnungsgemäß montiertes Gehäuse ein.</li> </ol>

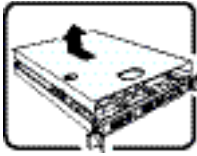
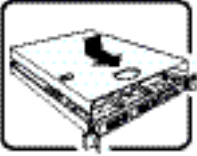
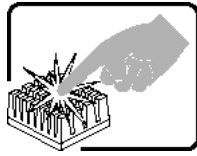
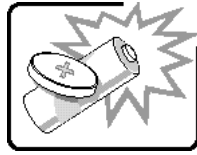

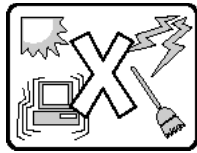
	<p><b>SICHERHEISSMASSNAHMEN:</b> Immer wenn Sie die Gehäuseabdeckung abnehmen um an das Systeminnere zu gelangen, sollten Sie folgende Schritte beachten:</p> <ol style="list-style-type: none"> <li>1. Schalten Sie alle an Ihr System angeschlossenen Peripheriegeräte aus.</li> <li>2. Schalten Sie das System mit dem Hauptschalter aus.</li> <li>3. Ziehen Sie den Stromanschlußstecker Ihres Systems aus der Steckdose.</li> <li>4. Auf der Rückseite des Systems beschriften und ziehen Sie alle Anschlußkabel von den I/O Anschlüssen oder Ports ab.</li> <li>5. Tragen Sie ein geerdetes Antistatik Gelenkband, um elektrostatische Ladungen (ESD) über blanke Metallstellen bei der Handhabung der Komponenten zu vermeiden.</li> <li>6. Schalten Sie das System niemals ohne ordnungsgemäß montiertes Gehäuse ein.</li> </ol>
	<p>Zur ordnungsgemäßen Kühlung und Lüftung muß die Gehäuseabdeckung immer wieder vor dem Einschalten installiert werden. Ein Betrieb des Systems ohne angebrachte Abdeckung kann Ihrem System oder Teile darin beschädigen. Um die Abdeckung wieder anzubringen:</p> <ol style="list-style-type: none"> <li>1. Vergewissern Sie sich, daß Sie keine Werkzeuge oder Teile im Innern des Systems zurückgelassen haben.</li> <li>2. Überprüfen Sie alle Kabel, Zusatzkarten und andere Komponenten auf ordnungsgemäßen Sitz und Installation.</li> <li>3. Bringen Sie die Abdeckungen wieder am Gehäuse an, indem Sie die zuvor gelösten Schrauben wieder anbringen. Ziehen Sie diese gut an.</li> <li>4. Bringen Sie die Verschlusseinrichtung (Padlock) wieder an und schließen Sie diese, um ein unerlaubtes Öffnen des Systems zu verhindern.</li> <li>5. Schließen Sie alle externen Kabel und den AC Stromanschlußstecker Ihres Systems wieder an.</li> </ol>
	<p>Der Mikroprozessor und der Kühler sind möglicherweise erhitzt, wenn das System in Betrieb ist. Außerdem können einige Platinen und Gehäuseteile scharfe Spitzen und Kanten aufweisen. Arbeiten an Platinen und Gehäuse sollten vorsichtig ausgeführt werden. Sie sollten Schutzhandschuhe tragen.</p>
	<p>Bei falschem Einsetzen einer neuen Batterie besteht Explosionsgefahr. Die Batterie darf nur durch denselben oder einen entsprechenden, vom Hersteller empfohlenen Batterietyp ersetzt werden. Entsorgen Sie verbrauchte Batterien den Anweisungen des Herstellers entsprechend.</p>



Das System wurde für den Betrieb in einer normalen Büroumgebung entwickelt. Der Standort sollte:

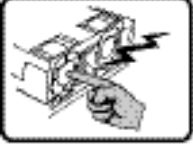
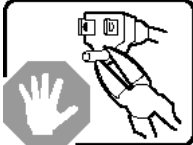

- "sauber und staubfrei sein (Hausstaub ausgenommen);
- "gut gelüftet und keinen Heizquellen ausgesetzt sein (einschließlich direkter Sonneneinstrahlung);
- "keinen Erschütterungen ausgesetzt sein;
- "keine starken, von elektrischen Geräten erzeugten elektromagnetischen Felder aufweisen;
- "in Regionen, in denen elektrische Stürme auftreten, mit einem Überspannungsschutzgerät verbunden sein; während eines elektrischen Sturms sollte keine Verbindung der Telekommunikationsleitungen mit dem Modem bestehen;
- "mit einer geerdeten Wechselstromsteckdose ausgerüstet sein;
- "über ausreichend Platz verfügen, um Zugang zu den Netzkabeln zu gewährleisten, da der Stromanschluß des Produkts hauptsächlich über die Kabel unterbrochen wird

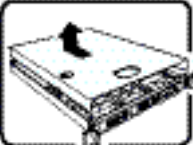
## Français

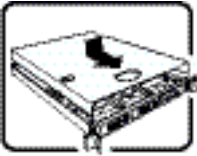
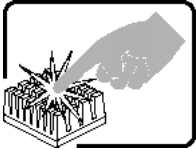
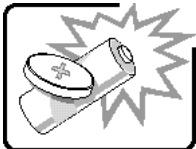
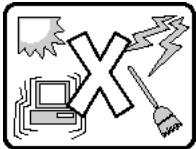
	<p>Le bloc d'alimentation de ce produit ne contient aucune pièce pouvant être réparée par l'utilisateur. Ce produit peut contenir plus d'un bloc d'alimentation. Veuillez contacter un technicien qualifié en cas de problème.</p>
	<p>Ne pas essayer d'utiliser ni modifier le câble d'alimentation CA fourni, s'il ne correspond pas exactement au type requis. Le nombre de câbles d'alimentation CA fournis correspond au nombre de blocs d'alimentation du produit</p>
	<p>Notez que le commutateur CC de mise sous tension /hors tension du panneau avant n'éteint pas l'alimentation CA du système. Pour mettre le système hors tension, vous devez débrancher chaque câble d'alimentation de sa prise.</p>
	<p><b>CONSIGNES DE SÉCURITÉ</b> -Lorsque vous ouvrez le boîtier pour accéder à l'intérieur du système, suivez les consignes suivantes:</p> <ol style="list-style-type: none"> <li>1. Mettez hors tension tous les périphériques connectés au système.</li> <li>2. Mettez le système hors tension en mettant l'interrupteur général en position OFF (bouton-poussoir).</li> <li>3. Débranchez tous les cordons d'alimentation c.a. du système et des prises murales.</li> <li>4. Identifiez et débranchez tous les câbles reliés aux connecteurs d'E-S ou aux accès derrière le système.</li> <li>5. Pour prévenir les décharges électrostatiques lorsque vous touchez aux composants, portez une bande antistatique pour poignet et reliez-la à la masse du système (toute surface métallique non peinte du boîtier).</li> <li>6. Ne faites pas fonctionner le système tandis que le boîtier est ouvert.</li> </ol>
	<p>Une fois TOUTES les étapes précédentes accomplies, vous pouvez retirer les panneaux du système. Procédez comme suit:</p> <ol style="list-style-type: none"> <li>1. Si un cadenas a été installé sur à l'arrière du système, déverrouillez-le et retirez-le.</li> <li>2. Retirez toutes les vis des panneaux et mettez-les dans un endroit sûr.</li> <li>3. Retirez les panneaux.</li> </ol>

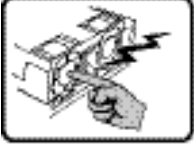
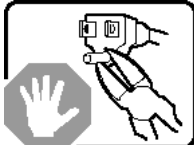
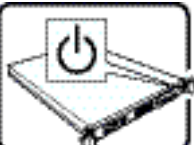

	<p>Afin de permettre le refroidissement et l'aération du système, réinstallez toujours les panneaux du boîtier avant de mettre le système sous tension. Le fonctionnement du système en l'absence des panneaux risque d'endommager ses pièces. Pour installer les panneaux, procédez comme suit:</p> <ol style="list-style-type: none"> <li>1. Assurez-vous de ne pas avoir oublié d'outils ou de pièces démontées dans le système.</li> <li>2. Assurez-vous que les câbles, les cartes d'extension et les autres composants sont bien installés.</li> <li>3. Revissez solidement les panneaux du boîtier avec les vis retirées plus tôt.</li> <li>4. Remettez le cadenas en place et verrouillez-le afin de prévenir tout accès non autorisé à l'intérieur du système.</li> <li>5. Rebranchez tous les cordons d'alimentation c. a. et câbles externes au système.</li> </ol>
	<p>Le microprocesseur et le dissipateur de chaleur peuvent être chauds si le système a été sous tension. Faites également attention aux broches aiguës des cartes et aux bords tranchants du capot. Nous vous recommandons l'usage de gants de protection.</p>
	<p>Danger d'explosion si la batterie n'est pas remontée correctement. Remplacer uniquement avec une batterie du même type ou d'un type équivalent recommandé par le fabricant. Disposez des piles usées selon les instructions du fabricant.</p>
	<p>Le système a été conçu pour fonctionner dans un cadre de travail normal. L'emplacement choisi doit être:</p> <ul style="list-style-type: none"> <li>• "Propre et dépourvu de poussière en suspension (sauf la poussière normale).</li> <li>• "Bien aéré et loin des sources de chaleur, y compris du soleil direct.</li> <li>• "A l'abri des chocs et des sources de vibrations.</li> <li>• "Isolé de forts champs électromagnétiques géenérés par des appareils électriques.</li> <li>• "Dans les régions sujettes aux orages magnétiques il est recomandé de brancher votre système à un supresseur de surtension, et de débrancher toutes les lignes de télécommunications de votre modem durant un orage.</li> <li>• "Muni d'une prise murale correctement mise à la terre.</li> <li>• "Suffisamment spacieux pour vous permettre d'accéder aux câbles d'alimentation (ceux-ci étant le seul moyen de mettre le système hors tension).</li> </ul>

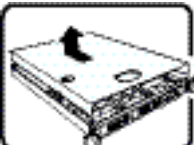
## Español

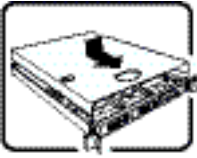
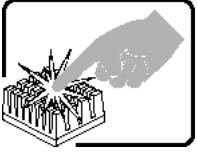
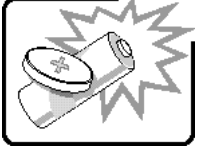
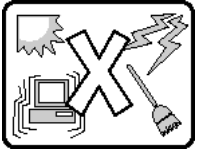
	<p>El usuario debe abstenerse de manipular los componentes de la fuente de alimentación de este producto, cuya reparación debe dejarse exclusivamente en manos de personal técnico especializado. Puede que este producto disponga de más de una fuente de alimentación</p>
	<p>No intente modificar ni usar el cable de alimentación de corriente alterna, si no corresponde exactamente con el tipo requerido. El número de cables suministrados se corresponden con el número de fuentes de alimentación de corriente alterna que tenga el producto</p>
	<p>Nótese que el interruptor activado/desactivado en el panel frontal no desconecta la corriente alterna del sistema. Para desconectarla, deberá desenchufar todos los cables de corriente alterna de la pared o desconectar la fuente de alimentación.</p>
	<p><b>INSTRUCCIONES DE SEGURIDAD:</b> Cuando extraiga la tapa del chasis para acceder al interior del sistema, siga las siguientes instrucciones:</p> <ol style="list-style-type: none"> <li>1. Apague todos los dispositivos periféricos conectados al sistema.</li> <li>2. Apague el sistema presionando el interruptor encendido/apagado.</li> <li>3. Desconecte todos los cables de alimentación CA del sistema o de las tomas de corriente alterna.</li> <li>4. Identifique y desconecte todos los cables enchufados a los conectores E/S o a los puertos situados en la parte posterior del sistema.</li> <li>5. Cuando manipule los componentes, es importante protegerse contra la descarga electrostática (ESD). Puede hacerlo si utiliza una muñequera antiestática sujeta a la toma de tierra del chasis - o a cualquier tipo de superficie de metal sin pintar.</li> <li>6. No ponga en marcha el sistema si se han extraído las tapas del chasis.</li> </ol>
	<p>Después de completar las seis instrucciones de <b>SEGURIDAD</b> mencionadas, ya puede extraer las tapas del sistema. Para ello:</p> <ol style="list-style-type: none"> <li>1. Desbloquee y extraiga el bloqueo de seguridad de la parte posterior del sistema, si se ha instalado uno.</li> <li>2. Extraiga y guarde todos los tornillos de las tapas. Extraiga las tapas.</li> </ol>

	<p>Para obtener un enfriamiento y un flujo de aire adecuados, reinstale siempre las tapas del chasis antes de poner en marcha el sistema. Si pone en funcionamiento el sistema sin las tapas bien colocadas puede dañar los componentes del sistema. Para instalar las tapas:</p> <ol style="list-style-type: none"> <li>1. Asegúrese primero de no haber dejado herramientas o componentes sueltos dentro del sistema.</li> <li>2. Compruebe que los cables, las placas adicionales y otros componentes se hayan instalado correctamente.</li> <li>3. Incorpore las tapas al chasis mediante los tornillos extraídos anteriormente, tensándolos firmemente.</li> <li>4. Inserte el bloqueo de seguridad en el sistema y bloquéelo para impedir que pueda accederse al mismo sin autorización.</li> <li>5. Conecte todos los cables externos y los cables de alimentación CA al sistema.</li> </ol>
	<p>Si el sistema ha estado en funcionamiento, el microprocesador y el disipador de calor pueden estar aún calientes. También conviene tener en cuenta que en el chasis o en el tablero puede haber piezas cortantes o punzantes. Por ello, se recomienda precaución y el uso de guantes protectores.</p>
	<p>Existe peligro de explosión si la pila no se cambia de forma adecuada. Utilice solamente pilas iguales o del mismo tipo que las recomendadas por el fabricante del equipo. Para deshacerse de las pilas usadas, siga igualmente las instrucciones del fabricante.</p>
	<p>El sistema está diseñado para funcionar en un entorno de trabajo normal. escoja un lugar:</p> <ul style="list-style-type: none"> <li>• "Limpio y libre de partículas en suspensión (salvo el polvo normal).</li> <li>• "Bien ventilado y alejado de fuentes de calor, incluida la luz solar directa.</li> <li>• "Alejado de fuentes de vibración.</li> <li>• "Aislado de campos electromagnéticos fuertes producidos por dispositivos eléctricos.</li> <li>• "En regiones con frecuentes tormentas eléctricas, se recomienda conectar su sistema a un eliminador de sobrevoltage y desconectar el módem de las líneas de telecomunicación durante las tormentas.</li> <li>• "Provisto de una toma de tierra correctamente instalada.</li> <li>• "Provisto de espacio suficiente como para acceder a los cables de alimentación, ya que éstos hacen de medio principal de desconexión del sistema.</li> </ul>

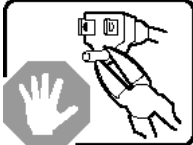
## Italiano

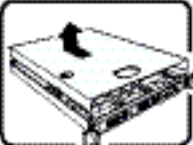
	<p>Rivolgersi ad un tecnico specializzato per la riparazione dei componenti dell'alimentazione di questo prodotto. È possibile che il prodotto disponga di più fonti di alimentazione.</p>
	<p>Non modificare o utilizzare il cavo di alimentazione in c.a. fornito dal produttore, se non corrisponde esattamente al tipo richiesto. Ad ogni fonte di alimentazione corrisponde un cavo di alimentazione in c.a. separato</p>
	<p>L'interruttore attivato/disattivato nel pannello anteriore non interrompe l'alimentazione in c.a. del sistema. Per interromperla, è necessario scollegare tutti i cavi di alimentazione in c.a. dalle prese a muro o dall'alimentazione di corrente.</p>
	<p><b>PASSI DI SICUREZZA:</b> Qualora si rimuovano le coperture del telaio per accedere all'interno del sistema, seguire i seguenti passi:</p> <ol style="list-style-type: none"> <li>1. Spegner tutti i dispositivi periferici collegati al sistema.</li> <li>2. Spegner il sistema, usando il pulsante spento/acceso dell'interruttore del sistema.</li> <li>3. Togliere tutte le spine dei cavi del sistema dalle prese elettriche.</li> <li>4. Identificare e sconnettere tutti i cavi attaccati ai collegamenti I/O od alle prese installate sul retro del sistema.</li> <li>5. Qualora si tocchino i componenti, proteggersi dallo scarico elettrostatico (SES), portando un cinghia anti-statica da polso che è attaccata alla presa a terra del telaio del sistema - qualsiasi superficie non dipinta - .</li> <li>6. Non far operare il sistema quando il telaio è senza le coperture.</li> </ol>
	<p>Dopo aver seguito i sei passi di SICUREZZA sopracitati, togliere le coperture del telaio del sistema come segue:</p> <ol style="list-style-type: none"> <li>1. Aprire e rimuovere il lucchetto dal retro del sistema qualora ve ne fosse uno installato.</li> <li>2. Togliere e mettere in un posto sicuro tutte le viti delle coperture.</li> <li>3. Togliere le coperture.</li> </ol>

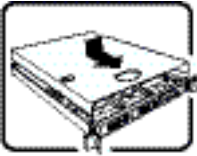
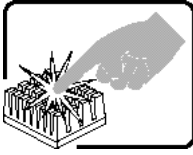
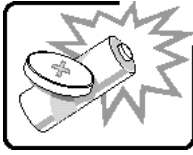
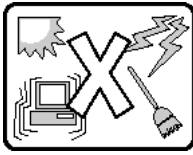

	<p>Per il giusto flusso dell'aria e raffreddamento del sistema, rimettere sempre le coperture del telaio prima di riaccendere il sistema. Operare il sistema senza le coperture al loro proprio posto potrebbe danneggiare i componenti del sistema. Per rimettere le coperture del telaio:</p> <ol style="list-style-type: none"> <li>1. Controllare prima che non si siano lasciati degli attrezzi o dei componenti dentro il sistema.</li> <li>2. Controllare che i cavi, dei supporti aggiuntivi ed altri componenti siano stati installati appropriatamente.</li> <li>3. Attaccare le coperture al telaio con le viti tolte in precedenza e avvitarle strettamente.</li> <li>4. Inserire e chiudere a chiave il lucchetto sul retro del sistema per impedire l'accesso non autorizzato al sistema.</li> <li>5. Ricollegare tutti i cavi esterni e le prolunghe AC del sistema.</li> </ol>
	<p>Se il sistema è stato a lungo in funzione, il microprocessore e il dissipatore di calore potrebbero essere surriscaldati. Fare attenzione alla presenza di piedini appuntiti e parti taglienti sulle schede e sul telaio. È consigliabile l'uso di guanti di protezione.</p>
	<p>Esiste il pericolo di un'esplosione se la pila non viene sostituita in modo corretto. Utilizzare solo pile uguali o di tipo equivalente a quelle consigliate dal produttore. Per disfarsi delle pile usate, seguire le istruzioni del produttore.</p>
	<p>Il sistema è progettato per funzionare in un ambiente di lavoro tipo. Scegliere una postazione che sia:</p> <ul style="list-style-type: none"> <li>• "Pulita e libera da particelle in sospensione (a parte la normale polvere presente nell'ambiente).</li> <li>• "Ben ventilata e lontana da fonti di calore, compresa la luce solare diretta.</li> <li>• "Al riparo da urti e lontana da fonti di vibrazione.</li> <li>• "Isolata dai forti campi magnetici prodotti da dispositivi elettrici.</li> <li>• "In aree soggette a temporali, è consigliabile collegare il sistema ad un limitatore di corrente. In caso di temporali, scollegare le linee di comunicazione dal modem.</li> <li>• "Dotata di una presa a muro correttamente installata.</li> <li>• "Dotata di spazio sufficiente ad accedere ai cavi di alimentazione, i quali rappresentano il mezzo principale di scollegamento del sistema.</li> </ul>

**This page intentionally left blank.**

# H Safety Information

## English

### Server Safety Information

This document applies to Intel® server boards, Intel® server chassis (pedestal and rack-mount) and installed peripherals. To reduce the risk of bodily injury, electrical shock, fire, and equipment damage, read this document and observe all warnings and precautions in this guide before installing or maintaining your Intel® server product.







In the event of a conflict between the information in this document and information provided with the product or on the website for a particular product, the product documentation takes precedence.

Your server should be integrated and serviced only by technically qualified persons.

You must adhere to the guidelines in this guide and the assembly instructions in your server manuals to ensure and maintain compliance with existing product certifications and approvals. Use only the described, regulated components specified in this guide. Use of other products / components voids the UL Listing and other regulatory approvals of the product, and may result in noncompliance with product regulations in the region(s) in which the product is sold.

### Safety Warnings and Cautions

To avoid personal injury or property damage, before you begin installing the product, read, observe, and adhere to all of the following safety instructions and information. The following safety symbols may be used throughout the documentation and may be marked on the product and / or the product packaging.

<b>CAUTION</b>	Indicates the presence of a hazard that may cause minor personal injury or property damage if the CAUTION is ignored.
<b>WARNING</b>	Indicates the presence of a hazard that may result in serious personal injury if the WARNING is ignored.
	Indicates potential hazard if indicated information is ignored.
	Indicates shock hazards that result in serious injury or death if safety instructions are not followed.
	Indicates hot components or surfaces.
	Indicates do not touch fan blades, may result in injury.
	Indicates to unplug all AC power cord(s) to disconnect AC power
	Please recycle battery

## Intended Application Uses

This product was evaluated as Information Technology Equipment (ITE), which may be installed in offices, schools, computer rooms, and similar commercial type locations. The suitability of this product for other product categories and environments (such as medical, industrial, residential, alarm systems, and test equipment), other than an ITE application, may require further evaluation.

## Site Selection

The system is designed to operate in a typical office environment. Choose a site that is:

- Clean, dry, and free of airborne particles (other than normal room dust).
- Well-ventilated and away from sources of heat including direct sunlight and radiators.
- Away from sources of vibration or physical shock.
- Isolated from strong electromagnetic fields produced by electrical devices.
- In regions that are susceptible to electrical storms, we recommend you plug your system into a surge suppressor and disconnect telecommunication lines to your modem during an electrical storm.
- Provided with a properly grounded wall outlet.
- Provided with sufficient space to access the power supply cord(s), because they serve as the product's main power disconnect.

## Equipment Handling Practices

Reduce the risk of personal injury or equipment damage:

- Conform to local occupational health and safety requirements when moving and lifting equipment.
- Use mechanical assistance or other suitable assistance when moving and lifting equipment.
- To reduce the weight for easier handling, remove any easily detachable components.

## Power and Electrical Warnings

**Caution:** *The power button, indicated by the stand-by power marking, DOES NOT completely turn off the system AC power, 5V standby power is active whenever the system is plugged in. To remove power from system, you must unplug the AC power cord from the wall outlet. Your system may use more than one AC power cord. Make sure all AC power cords are*

*unplugged. Make sure the AC power cord(s) is/are unplugged before you open the chassis, or add or remove any non hot-plug components.*

*Do not attempt to modify or use an AC power cord if it is not the exact type required. A separate AC cord is required for each system power supply.*

*Some power supplies in Intel® servers use Neutral Pole Fusing. To avoid risk of shock use caution when working with power supplies that use Neutral Pole Fusing.*

*The power supply in this product contains no user-serviceable parts. Do not open the power supply. Hazardous voltage, current and energy levels are present inside the power supply. Return to manufacturer for servicing.*

*When replacing a hot-plug power supply, unplug the power cord to the power supply being replaced before removing it from the server.*

*To avoid risk of electric shock, turn off the server and disconnect the power cord, telecommunications systems, networks, and modems attached to the server before opening it.*

## Power Cord Warnings

If an AC power cord was not provided with your product, purchase one that is approved for use in your country.

**Caution:** *To avoid electrical shock or fire, check the power cord(s) that is used with the product as follows:*

- *Do not attempt to modify or use the AC power cord(s) if they are not the exact type required to fit into the grounded electrical outlets*
- *The power cord(s) must meet the following criteria:*
- *The power cord must have an electrical rating that is greater than that of the electrical current rating marked on the product.*
- *The power cord must have safety ground pin or contact that is suitable for the electrical outlet.*
- *The power supply cord(s) is/are the main disconnect device to AC power. The socket outlet(s) must be near the equipment and readily accessible for disconnection.*
- *The power supply cord(s) must be plugged into socket-outlet(s) that is /are provided with a suitable earth ground.*

## System Access Warnings

**Caution:** *To avoid personal injury or property damage, the following safety instructions apply whenever accessing the inside of the product:*

- *Turn off all peripheral devices connected to this product.*
- *Turn off the system by pressing the power button to off.*
- *Disconnect the AC power by unplugging all AC power cords from the system or wall outlet.*

## Safety Information

- *Disconnect all cables and telecommunication lines that are connected to the system.*
- *Retain all screws or other fasteners when removing access cover(s). Upon completion of accessing inside the product, refasten access cover with original screws or fasteners.*
- *Do not access the inside of the power supply. There are no serviceable parts in the power supply. Return to manufacturer for servicing.*
- *Power down the server and disconnect all power cords before adding or replacing any non hot-plug component.*
- *When replacing a hot-plug power supply, unplug the power cord to the power supply being replaced before removing the power supply from the server.*

**Caution:** *If the server has been running, any installed processor(s) and heat sink(s) may be hot. Unless you are adding or removing a hot-plug component, allow the system to cool before opening the covers. To avoid the possibility of coming into contact with hot component(s) during a hot-plug installation, be careful when removing or installing the hot-plug component(s).*

**Caution:** *To avoid injury do not contact moving fan blades. If your system is supplied with a guard over the fan, do not operate the system without the fan guard in place.*

## Rack Mount Warnings

The equipment rack must be anchored to an unmovable support to prevent it from tipping when a server or piece of equipment is extended from it. The equipment rack must be installed according to the rack manufacturer's instructions.

Install equipment in the rack from the bottom up, with the heaviest equipment at the bottom of the rack.

Extend only one piece of equipment from the rack at a time.

You are responsible for installing a main power disconnect for the entire rack unit. This main disconnect must be readily accessible, and it must be labeled as controlling power to the entire unit, not just to the server(s).

To avoid risk of potential electric shock, a proper safety ground must be implemented for the rack and each piece of equipment installed in it.

## Electrostatic Discharge (ESD)

**Caution:** *ESD can damage disk drives, boards, and other parts. We recommend that you perform all procedures at an ESD workstation. If one is not available, provide some ESD protection by wearing an antistatic wrist strap attached to chassis ground -- any unpainted metal surface -- on your server when handling parts.*

*Always handle boards carefully. They can be extremely sensitive to ESD. Hold boards only by their edges. After removing a board from its protective wrapper or from the server, place the board component side up on a grounded, static free surface. Use a*

*conductive foam pad if available but not the board wrapper. Do not slide board over any surface.*

## Other Hazards

### Battery Replacement

**Caution:** *There is the danger of explosion if the battery is incorrectly replaced. When replacing the battery, use only the battery recommended by the equipment manufacturer.*

*Dispose of batteries according to local ordinances and regulations.*

*Do not attempt to recharge a battery.*

*Do not attempt to disassemble, puncture, or otherwise damage a battery.*

### Cooling and Airflow

**Caution:** *Carefully route cables as directed to minimize airflow blockage and cooling problems.*

*For proper cooling and airflow, operate the system only with the chassis covers installed. Operating the system without the covers in place can damage system parts. To install the covers:*

- *Check first to make sure you have not left loose tools or parts inside the system.*
- *Check that cables, add-in boards, and other components are properly installed.*
- *Attach the covers to the chassis according to the product instructions.*

### Laser Peripherals or Devices

**Caution:** *To avoid risk of radiation exposure and/or personal injury:*

- *Do not open the enclosure of any laser peripheral or device*
- *Laser peripherals or devices have are not user serviceable*
- *Return to manufacturer for servicing*

## Deutsch

### Sicherheitshinweise für den Server

Das vorliegende Dokument bezieht sich auf Intel® Serverplatinen, Intel® Servergehäuse (Standfuß und Rack) sowie installierte Peripheriegeräte. Es enthält Warnungen und Vorsichtsmaßnahmen zur Vermeidung von Gefahren durch Verletzung, Stromschlag, Feuer und Beschädigungen von Geräten. Lesen Sie diese Dokument daher sorgfältig, bevor Sie Ihr Intel® Serverprodukt installieren oder warten.







Bei Widersprüchen zwischen den hier vorliegenden Angaben und den Informationen im Lieferumfang des Produkts oder auf der Website des betreffenden Produkts hat die Produktdokumentation Vorrang.

Die Integration und Wartung des Servers darf nur durch technisch qualifizierte Personen erfolgen.

Um die Einhaltung der vorhandenen Zulassungen und Genehmigungen für das Produkt zu gewährleisten, sind die Richtlinien in diesem Handbuch sowie die Montageanleitungen in den Serverhandbüchern zu beachten. Verwenden Sie nur die beschriebenen, zugelassenen Komponenten, die im vorliegenden Handbuch angegeben werden. Die Verwendung anderer Produkte oder Komponenten führt zum Erlöschen der UL-Zulassung und anderer Genehmigungen für das Produkt. Dadurch kann das Produkt gegen Produktbestimmungen verstoßen, die im Verkaufsland gelten.

### Sicherheitshinweise und Vorsichtsmaßnahmen

Um Verletzungen und Beschädigungen zu vermeiden, sollten Sie vor dem Beginn der Produktinstallation die nachfolgend aufgeführten Sicherheitshinweise und -informationen sorgfältig lesen und befolgen. In dem vorliegenden Handbuch sowie auf dem Produkt und auf der Verpackung werden folgende Sicherheitssymbole verwendet:

<b>VORSICHT</b>	Weist auf eine Gefahrenquelle hin, die bei Nichtbeachtung des VORSICHTSHINWEISES zu leichteren Verletzungen bzw. Sachbeschädigungen führen kann.
<b>WARNUNG</b>	Weist auf eine Gefahrenquelle hin, die bei Nichtbeachtung der WARNUNG zu ernstesten Verletzungen führen kann.
	Weist auf potentielle Gefahr bei Nichtbeachtung der angezeigten Informationen hin.
	Weist auf die Gefahr eines Stromschlags hin, der bei Nichtbeachtung der Sicherheitshinweise zu schweren oder tödlichen Verletzungen führen kann.
	Weist auf Verbrennungsgefahr an heißen Bauteilen bzw. Oberflächen hin.
	Weist darauf hin, daß das Anfassen des Gebläses zu Verletzungen führen kann.
	Bedeutet, alle Netzkabel abzuziehen und das Gerät von der Netzspannung zu trennen.
	Bereiten Sie bitte Batterie auf



## Zielbenutzer der Anwendung

Dieses Produkt wurde in seiner Eigenschaft als IT-Gerät getestet, das in Büros, Schulen, Computerräumen und ähnlichen öffentlichen Räumlichkeiten installiert werden kann. Die Eignung dieses Produkts für andere Einsatzbereiche als IT (z. B. Medizin, Industrie, Alarmsysteme oder Prüfgeräte) kann u. U. weitere Tests erfordern.

## Standortauswahl

Das System ist für den Betrieb innerhalb normaler Büroumgebungen geeignet. Wählen Sie einen Standort, der folgenden Kriterien entspricht:

- Sauber, trocken und frei von Partikeln in der Luft (außer dem normalen Raumstaub).
- Gut belüftet, nicht in der Nähe von Wärmequellen und keiner direkten Sonnenbestrahlung ausgesetzt.
- Nicht in der Nähe von Vibrations- oder Erschütterungsquellen.
- Abgeschirmt von starken elektromagnetischen Feldern, die durch elektrische Geräte erzeugt werden.
- In gewittergefährdeten Gebieten sollten Sie das System an einen Überspannungsschutz anschließen und bei einem Gewitter die Telekommunikationskabel zum Modem abziehen.
- Eine ordnungsgemäß geerdete Wandsteckdose muß vorhanden sein.
- Ausreichender Freiraum für den Zugang zu den Netzkabeln, da diese die Hauptvorrichtung zum Trennen des Produkts von der Stromversorgung sind.

## Handhabung von Geräten

Beachten Sie zur Vermeidung von Verletzungen oder Beschädigungen an den Geräten die folgenden Hinweise:

- Halten Sie beim Transportieren und Anheben von Geräten die örtlichen Gesundheits- und Sicherheitsvorschriften ein.
- Verwenden Sie mechanische oder andere geeignete Hilfsmittel zum Transportieren oder Anheben von Geräten.
- Entfernen Sie alle Komponenten, die sich leicht abnehmen lassen, um das Gewicht zu reduzieren und die Handhabung zu erleichtern.

## Warnungen zu Netzspannung und Elektrizität

**Vorsicht:** Durch Betätigen der mit dem Standby-Symbol gekennzeichneten Netztaste wird das System NICHT vollständig vom Netz getrennt. Es sind weiterhin 5 V aktiv, solange das System eingesteckt ist. Um das System vollständig vom Strom zu trennen, muß das Netzkabel aus der Steckdose abgezogen werden. Das System verfügt möglicherweise über mehrere Netzkabel. Vergewissern Sie sich in diesem Fall, daß alle Netzkabel abgezogen sind. Wenn Sie Komponenten ein- oder ausbauen möchten, die nicht hot-plug-fähig sind, stellen Sie sicher, daß zuvor alle Netzkabel abgezogen sind.

Nehmen Sie keine Änderungen am Netzkabel vor, und verwenden Sie kein Kabel, das nicht genau dem geforderten Typ entspricht. Jedes Netzteil im System muß über ein eigenes Netzkabel angeschlossen werden.

Einige Netzteile von Intel Servern verwenden Nullleitersicherungen. Vorsicht ist geboten im Umgang mit Netzteilen, welche Nullleitersicherungen verwenden, um das Risiko eines elektrischen Schlages zu vermeiden

Das Netzteil in diesem Produkt enthält keine Teile, die vom Benutzer gewartet werden können. Öffnen Sie das Netzteil nicht. Im Netzteil bestehen gefährliche Spannungen, Ströme und Energiequellen. Schicken Sie das Gerät für Wartungsarbeiten an den Hersteller zurück.

Wenn Sie ein hot-plug-fähiges Netzteil austauschen, ziehen Sie dessen Netzkabel ab, bevor Sie es aus dem Server ausbauen.

Zur Vermeidung von Stromschlägen schalten Sie den Server aus, und trennen Sie vor dem Öffnen des Geräts das Netzkabel sowie alle an den Server angeschlossene Telekommunikationssysteme, Netzwerke und Modems.

## Hinweis für Netzkabel

Wenn kein Netzkabel mit dem Produkt geliefert wurde, kaufen Sie ein Kabel, das für die

**Vorsicht:** Prüfen Sie zur Vermeidung von Stromschlag- oder Feuergefahr die mit dem Produkt zu verwendenden Netzkabel wie folgt:

- Nehmen Sie keine Änderungen an einem Netzkabel vor, und benutzen sie es nicht, wenn es nicht genau in die geerdeten Netzsteckdosen paßt.
- Netzkabel müssen die folgenden Anforderungen erfüllen:
- Die Nennbelastbarkeit des Netzkabels muß mindestens so hoch sein wie die am Produkt angegebenen Nennstromaufnahme.
- Das Netzkabel muß einen zur Netzsteckdose passenden Schutzkontakt besitzen.
- Die Netzkabel sind die Hauptvorrichtung zum Trennen des Geräts vom Stromnetz. Die Steckdose muß in der Nähe der Anlage angebracht und gut erreichbar sein.
- Netzkabel müssen an eine ordnungsgemäß geerdete Steckdose angeschlossen sein.

## Warnhinweise für den Systemzugang

**Vorsicht:** Um Verletzungen und Beschädigungen zu vermeiden, sollten Sie vor Arbeiten im Produktinneren folgende Sicherheitsanweisungen beachten:

- Schalten Sie alle am Produkt angeschlossenen Peripheriegeräte aus.
- Schalten Sie das System mit dem Netzschalter aus.
- Trennen Sie das Gerät von der Stromquelle, indem Sie alle Netzkabel vom System bzw. aus der Steckdose ziehen.
- Ziehen Sie alle Kabel und alle an das System angeschlossenen Telekommunikationsleitungen ab.
- Bewahren Sie alle Schrauben und anderen Befestigungselemente gut auf, nachdem Sie die Gehäuseabdeckung entfernt haben. Wenn Sie Ihre Arbeiten im Systeminneren beendet haben, befestigen Sie die Gehäuseabdeckung mit den Originalschrauben bzw. -befestigungselementen.
- Führen Sie keine Arbeiten im Netzteil aus. Das Netzteil enthält keine für den Benutzer wartungsbedürftigen Teile. Schicken Sie das Gerät für Wartungsarbeiten an den Hersteller zurück.
- Schalten Sie den Server aus, und ziehen Sie alle Netzkabel ab, bevor Sie Komponenten ein- oder ausbauen, die nicht hot-plug-fähig sind.
- Wenn Sie ein hot-plug-fähiges Netzteil austauschen, ziehen Sie dessen Netzkabel ab, bevor Sie es aus dem Server ausbauen.

**Vorsicht:** War Ihr Server in Betrieb, können die installierten Prozessoren und Kühlkörper heiß sein. Sofern Sie keine Hot-Plug-Komponenten ein- oder ausbauen, warten Sie mit dem Abnehmen der Abdeckungen, bis das System abgekühlt ist. Gehen Sie beim Aus- oder Einbauen von Hot-Plug-Komponenten sorgfältig vor, um nicht mit heißen Komponenten in Berührung zu kommen.

**Vorsicht:** Berühren Sie nicht die rotierenden Lüfterflügel, um Verletzungen zu vermeiden. Falls Ihr System mit einer Lüfterabdeckung besitzt, darf es nicht ohne diese Abdeckung betrieben werden.

## Warnhinweise für Racks

Das Geräte-Rack muß auf einer geeigneten, festen Unterlage verankert werden, um ein Umkippen zu vermeiden, wenn ein Server oder andere Geräte herausgezogen werden. Bei der Installation des Racks müssen die Anweisungen des Rack-Herstellers beachtet werden.

Gehen Sie bei der Installation von Geräten im Rack immer von unten nach oben vor, und bauen Sie das schwerste Gerät an der untersten Position im Rack ein.

Ziehen Sie jeweils immer nur ein Gerät aus dem Rack heraus.

Sie müssen für die gesamte Rack-Einheit einen Netztrennschalter einrichten. Dieser Netztrennschalter muß leicht zugänglich sein und über eine Kennzeichnung verfügen, die besagt, daß er die Stromzufuhr zur gesamten Einheit steuert und nicht nur zu den Servern.

Zur Vermeidung von Stromschlaggefahr müssen das Rack selbst und alle darin eingebauten Geräte ordnungsgemäß geerdet sein.

## Elektrostatische Entladungen (ESD)

**Vorsicht:** *Elektrostatische Entladungen können zur Beschädigung von Festplatten, Platinen und anderen Komponenten führen. Daher sollten Sie alle Arbeiten an einer ESD-Workstation ausführen. Steht ein solcher Arbeitsplatz nicht zur Verfügung, erzielen Sie einen gewissen Schutz vor elektrostatischen Entladungen durch Tragen einer Antistatik-Manschette, die Sie während der Arbeit zur Erdung an einem beliebigen unlackierten Metallteil des Computergehäuses befestigen.*

*Gehen Sie bei der Handhabung von Platinen immer mit größter Vorsicht vor. Sie können äußerst empfindlich gegenüber elektrostatischer Entladung sein. Halten Sie Platinen nur an den Kanten fest. Legen Sie die Platinen nach dem Auspacken aus der Schutzhülle oder nach dem Ausbau aus dem Server mit der Bauelementseite nach oben auf eine geerdete, statisch entladene Unterlage. Verwenden Sie dazu, sofern verfügbar, eine leitfähige Schaumstoffunterlage, aber nicht die Schutzhülle der Platine. Ziehen Sie die Platine nicht über eine Fläche.*

## Andere Gefahren

### Batterieaustausch

**Vorsicht:** Wird die Batterie unsachgemäß ausgetauscht, besteht Explosionsgefahr. Verwenden Sie als Ersatz nur die vom Gerätehersteller empfohlene Batterie.

Beachten Sie bei der Entsorgung von Batterien die gültigen Bestimmungen.

Versuchen Sie nicht, eine Batterie aufzuladen.

Versuchen Sie nicht, eine Batterie zu öffnen oder sonstwie zu beschädigen.

### Kühlung und Luftstrom

**Vorsicht:** Verlegen Sie Kabel sorgfältig entsprechend der Anleitung, um Störungen des Luftstroms und Kühlungsprobleme zu vermeiden.

Zur Gewährleistung des ordnungsgemäßen Kühlungs- und Luftstromverhaltens darf das System nur mit angebrachten Gehäuseabdeckungen betrieben werden. Die Inbetriebnahme des Systems ohne Abdeckung kann zur Beschädigung von Systemkomponenten führen. So bringen Sie die Abdeckung wieder an:

- Vergewissern Sie sich zunächst, daß Sie keine Werkzeuge oder Teile im Gehäuse vergessen haben.
- Prüfen Sie, ob Kabel, Erweiterungskarten sowie weitere Komponenten ordnungsgemäß angebracht sind.
- Befestigen Sie die Abdeckungen am Gehäuse des Produkts, wie in dessen Anleitung beschrieben.

### Laser-Peripheriegeräte oder -Komponenten

**Vorsicht:** Beachten Sie zur Vermeidung von Strahlung und Verletzungen die folgenden Hinweise:

- Öffnen Sie keinesfalls das Gehäuse von Laser-Peripheriegeräten oder Laser-Komponenten.
- Laser-Peripheriegeräte oder -Komponenten besitzen keine für den Benutzer wartungsbedürftigen Teile.
- Schicken Sie das Gerät für Wartungsarbeiten an den Hersteller zurück.

## Français

### Consignes de sécurité sur le serveur

Ce document s'applique aux cartes serveur Intel®, au châssis de serveur Intel® (sur pieds et sur rack) et aux périphériques installés. Pour réduire les risques de dommages corporels, d'électrocution, d'incendie et de dommages matériels, lisez ce document et respectez tous les avertissements et précautions mentionnés dans ce guide avant d'installer ou de mettre à jour votre produit serveur Intel®.







En cas de conflit entre les informations fournies dans ce document et celles livrées avec le produit ou publiées sur le site Web pour un produit particulier, la documentation du produit prime.

Votre serveur doit être intégré et entretenu uniquement par des techniciens qualifiés.

Vous devez suivre les informations de ce guide et les instructions d'assemblage des manuels de serveur pour vérifier et maintenir la conformité avec les certifications et approbations de produit existantes. Utilisez uniquement les composants décrits et réglementés spécifiés dans ce guide. L'utilisation d'autres produits/composants annulera la liste UL et les autres approbations réglementaires du produit, et le produit peut ne pas être conforme aux autres lois et réglementations locales applicables au produit.

### Sécurité: avertissements et mises en garde

Pour éviter de vous blesser ou d'endommager votre équipement, lisez et respectez toutes les informations et consignes de sécurité avant de commencer l'installation du produit. Les symboles de sécurité suivants peuvent être utilisés tout au long de cette documentation et peuvent figurer sur le produit ou sur son emballage.

<b>ATTENTION</b>	Indique la présence d'un risque pouvant entraîner des blessures physiques mineures ou endommager légèrement le matériel si la mise en garde n'est pas prise en compte.
<b>AVERTISSEMENT</b>	Indique la présence d'un risque pouvant entraîner des blessures corporelles graves si l'avertissement n'est pas pris en compte.
	Indique un risque potentiel si les informations signalées ne sont pas prises en compte.
	Indique des risques d'électrocution pouvant entraîner des blessures corporelles graves ou mortelles si les consignes de sécurité ne sont pas respectées.
	Signale des composants ou des surfaces soumis à des températures élevées.
	Indique de ne pas toucher aux pales de ventilateur, car cela peut entraîner des blessures.
	Indique de débrancher tous les cordons d'alimentation secteur pour déconnecter l'alimentation.
	Veuillez réutiliser la batterie

## Domaines d'utilisation prévus

Ce produit a été testé comme équipement informatique (ITE) et peut être installé dans des bureaux, des écoles, des salles informatiques et des endroits commerciaux similaires. L'utilisation du présent produit dans des catégories et environnements de produits et domaines d'application (par exemple, le domaine médical, industriel, résidentiel, les systèmes d'alarme et les appareils de contrôle) autres qu'ITE doit faire l'objet d'évaluations supplémentaires.

## Sélection d'un emplacement

Le système est conçu pour fonctionner dans un environnement standard de bureau. Choisissez un emplacement respectant les conditions suivantes :

- Propre, sec et exempt de particules en suspension (autres que la poussière normale d'une pièce).
- Bien ventilé et à l'écart des sources de chaleur telles que la lumière directe du soleil et les radiateurs.
- À l'écart des sources de vibration ou des chocs physiques.
- Isolé des champs électromagnétiques importants produits par des appareils électriques.
- Dans les régions sujettes aux orages magnétiques, nous vous recommandons de brancher votre système à un suppresseur de surtension et de déconnecter les lignes de télécommunication de votre modem pendant les orages.
- Équipé d'une prise murale reliée à la terre.
- Équipé d'un espace suffisant pour accéder aux cordons d'alimentation secteur, car ils servent de disjoncteur principal d'alimentation du produit.

## Pratiques de manipulation de l'équipement

Réduisez le risque de dommages personnels ou matériels :

- Conformez-vous aux exigences de médecine du travail et de sécurité lorsque vous déplacez et soulevez le matériel.
- Utilisez l'assistance mécanique ou toute autre assistance appropriée lorsque vous déplacez et soulevez le matériel.
- Pour réduire le poids en vue de faciliter la manipulation, retirez tout composant amovible.

## Alimentation et avertissements en matière d'électricité

**Attention:** Le bouton d'alimentation, indiqué par le symbole de mise en veille, NE COUPE PAS complètement l'alimentation secteur du système car le courant de veille 5 V reste actif lorsque le système est sous tension. Pour couper l'alimentation du système, vous devez débrancher le cordon d'alimentation secteur de la prise murale. Votre système peut utiliser plusieurs cordons d'alimentation secteur. Assurez-vous que tous les cordons d'alimentation sont débranchés. Vous devez les débrancher avant d'ouvrir le châssis, d'ajouter ou de supprimer un composant non connectable à chaud.

Les alimentations de certains serveurs Intel sont munies de doubles fusibles pôle/neutre: veuillez observer les précautions d'usage afin d'éviter tout risque d'électrocution.

N'essayez pas de modifier ou d'utiliser un cordon d'alimentation secteur s'il ne s'agit pas du type exact requis. Un cordon secteur est requis pour chaque alimentation système.

Le bloc d'alimentation de ce produit ne contient aucun composant réparable par l'utilisateur. N'ouvrez pas le bloc d'alimentation. L'intérieur de celui-ci est soumis à des niveaux dangereux de tension, de courant et d'énergie. Renvoyez-le au fabricant en cas de problème.

Lorsque vous remplacez un bloc d'alimentation à chaud, débranchez le cordon du bloc d'alimentation en cours de remplacement avant de le retirer du serveur.

Pour éviter tout risque d'électrocution, mettez le système hors tension et débranchez les cordons d'alimentation ainsi que les systèmes de télécommunication, réseaux et modems reliés au système avant d'ouvrir ce dernier.

## Avertissements sur le cordon d'alimentation

Si aucun cordon d'alimentation secteur n'a été fourni avec votre produit, vous devez vous en procurer un qui soit approuvé pour une utilisation dans votre pays.

**Attention:** Pour éviter tout risque d'électrocution ou d'incendie, vérifiez les cordons d'alimentation qui seront utilisés avec le produit comme suit:

- N'essayez pas d'utiliser ou de modifier les cordons d'alimentation en CA s'ils ne correspondent pas exactement au type requis pour les prises électriques reliées à la terre.
- Les cordons d'alimentation doivent répondre aux critères suivants :
- Le cordon d'alimentation doit supporter une intensité supérieure à celle indiquée sur le produit.
- Le cordon d'alimentation doit posséder une broche ou un contact de mise à la terre approprié à la prise électrique.
- Les cordons d'alimentation électrique représentent le principal dispositif de déconnexion raccordé à l'alimentation secteur. Les prises de courant doivent se trouver à proximité de l'équipement et être facilement accessibles pour une déconnexion.
- Les cordons d'alimentation doivent être branchés sur des prises électriques correctement reliées à la terre.



## Avertissements sur l'accès au système

**Attention:** Pour éviter de vous blesser ou d'endommager votre équipement, les consignes de sécurité suivantes s'appliquent chaque fois que vous accédez à l'intérieur du produit:

- Mettez hors tension tous les périphériques connectés à ce produit.
- Éteignez le système en appuyant sur le bouton d'alimentation.
- Déconnectez l'alimentation secteur en débranchant tous les cordons d'alimentation secteur du système ou de la prise murale.
- Déconnectez l'ensemble des câbles et lignes de télécommunication qui sont connectés au système.
- Mettez toutes les vis ou autres attaches de côté lorsque vous retirez les panneaux d'accès. Une fois que vous avez terminé d'accéder à l'intérieur du produit, refixez le panneau d'accès avec les vis ou attaches d'origine.
- N'essayez pas d'accéder à l'intérieur du bloc d'alimentation. Il ne contient aucune pièce réparable. Renvoyez-le au fabricant en cas de problème.
- Mettez le serveur hors tension et débranchez tous les cordons d'alimentation avant d'ajouter ou de remplacer tout composant non connectable à chaud.
- Lorsque vous remplacez le bloc d'alimentation à chaud, débranchez le cordon du bloc d'alimentation en cours de remplacement avant de retirer le bloc du serveur.

**Attention:** Si le serveur a été utilisé, les processeurs et dissipateurs de chaleur installés peuvent être chauds. À moins que vous n'ajoutiez ou ne retiriez un composant connectable à chaud, laissez le système refroidir avant d'ouvrir les panneaux. Pour éviter tout risque d'entrer en contact avec un composant chaud lors d'une installation à chaud, prenez toutes les précautions nécessaires lorsque vous retirez ou installez des composants connectables à chaud.

**Attention:** Pour éviter de vous blesser, ne touchez pas les pales de ventilateur en mouvement. Si votre système est fourni avec une protection sur le ventilateur, ne mettez pas le système en route sans la protection en place.

## Avertissements sur le montage en rack

Le rack doit être fixé à un support inamovible pour éviter qu'il ne bascule lors de l'extension d'un serveur ou d'un élément de l'équipement. Le rack doit être installé conformément aux instructions du fabricant.

Installez les équipements dans le rack en partant du bas, en plaçant le plus lourd en bas du rack.

N'étendez qu'un seul élément de l'équipement à partir du rack à la fois.

Vous êtes responsable de l'installation d'un disjoncteur principal d'alimentation pour la totalité du rack. Ce disjoncteur principal doit être rapidement accessible et doit être étiqueté comme contrôlant toute l'unité, et pas uniquement le ou les serveurs.

Pour éviter tout risque d'électrocution, le rack et chaque élément de l'équipement installé dans le rack doivent être correctement reliés à la terre.

## Décharges électrostatiques (ESD)

**Attention:** *Les décharges électrostatiques (ESD) peuvent endommager les lecteurs de disque dur, les cartes et d'autres pièces. Il est fortement conseillé d'effectuer l'ensemble des procédures décrites à un poste de travail protégé contre les ESD. Au cas où aucun poste de ce type ne serait disponible, protégez-vous contre les ESD en portant un bracelet antistatique relié à la masse du châssis (n'importe quelle surface métallique non peinte) de votre serveur lorsque que vous manipulez les pièces.*

*Manipulez toujours les cartes avec précaution. Elles peuvent être extrêmement sensibles aux ESD. Ne tenez les cartes que par leurs bords. Après avoir retiré une carte de son emballage de protection ou du serveur, placez-la sur une surface reliée à la terre, exempte de charge statique, composants orientés vers le haut. Utilisez si possible un tapi de mousse conducteru, mais pas l'emballage de la carte. Veillez à ce que la carte ne glisse sur aucune surface.*

## Autres risques

### Remplacement de la pile

**Attention:** Il existe un risque d'explosion si la pile n'est pas correctement remplacée. Lors du remplacement de la pile, utilisez uniquement celle recommandée par le fabricant du matériel.

Mettez la pile au rebut en vous conformant aux réglementations locales.

N'essayez pas de recharger une pile.

N'essayez pas de démonter, de percer ou d'endommager la pile d'une quelconque façon.

### Refroidissement et ventilation

**Attention:** Routez les câbles avec précaution comme indiqué pour minimiser les blocages de circulation d'air et les problèmes de refroidissement.

Afin de permettre une ventilation et un refroidissement corrects, ne mettez le système en marche que lorsque les panneaux du châssis sont en place. L'utilisation du système sans les panneaux peut endommager les composants système. Pour installer les panneaux :

- Vérifiez tout d'abord que vous n'avez pas oublié d'outils ou de composants détachés à l'intérieur du système.
- Vérifiez que les câbles, les cartes d'extension et les autres composants sont correctement installés.
- Fixez les panneaux au châssis en suivant les instructions du produit.

### Périphériques laser

**Attention:** Pour éviter tout risque d'exposition aux rayonnements et/ou de dommage personnel:

- N'ouvrez pas l'enceinte d'un périphérique laser.
- Les périphériques laser ne sont pas réparables par l'utilisateur.
- Retournez-les au fabricant en cas de problème.

## Español

### Información de seguridad del servidor

Este documento se aplica a las tarjetas de servidor de Intel<sup>®</sup>, los gabinetes de servidor de Intel<sup>®</sup> (montaje en rack y en pedestal) y los dispositivos periféricos. Para reducir el riesgo de daños corporales, descargas eléctricas, fuego y en el equipo, lea este documento y preste atención a todas las advertencias y precauciones de esta guía antes de instalar o mantener el producto de servidor de Intel<sup>®</sup>.







En el caso de que haya diferencias entre la información para un producto en particular contenida en este documento y la información proporcionada con dicho producto o en el sitio Web, la documentación del producto es la que prevalece.

Sólo personal técnico calificado debe montar y prestar los servicios para el servidor.

Debe ceñirse a las directrices de esta guía y a las instrucciones de montaje de los manuales del servidor para asegurar y mantener el cumplimiento con las certificaciones y homologaciones existentes de los productos. Utilice sólo los componentes descritos y homologados que se especifican en esta guía. El uso de otros productos o componentes anulará la homologación UL y otras certificaciones oficiales del producto, pudiendo dejar de ser compatible con las normativas locales de los países en los que se comercializa.

### Advertencias y precauciones sobre seguridad

Para reducir la posibilidad de que se produzcan lesiones personales o daños en la propiedad, antes de empezar a instalar el producto, lea, observe y cumpla toda la información e instrucciones de seguridad siguientes. Puede que se utilicen los siguientes símbolos de seguridad en la documentación y es posible que aparezcan en el producto o en su embalaje.

<b>PRECAUCIÓN</b>	Indica la existencia de un riesgo que podría causar lesiones personales o daños en la propiedad leves si no se tiene en cuenta la PRECAUCIÓN.
<b>ADVERTENCIA</b>	Indica la existencia de un riesgo que podría causar lesiones personales graves si no se tiene en cuenta la ADVERTENCIA.
	Indica un riesgo potencial si no se tiene en cuenta la información indicada.
	Indica riesgo de descargas eléctricas que podrían causar lesiones graves o la muerte si no se siguen las instrucciones de seguridad.
	Indica componentes o superficies calientes.
	Indica que no se deben tocar las aspas de los ventiladores, ya que de lo contrario se podrían producir lesiones.
	Indica que es necesario desenchufar los cables de alimentación de CA para desconectar la alimentación de CA
	Recicle por favor la batería

## Aplicaciones y usos previstos

Este producto ha sido evaluado como equipo de tecnología informática (ITE) que puede instalarse en oficinas, escuelas, salas de equipos informáticos o lugares de ámbito comercial similares. Es posible que sea necesario llevar a cabo una evaluación adicional para comprobar si este producto es apropiado para otras categorías de productos y entornos además de las aplicaciones informáticas (por ejemplo, soluciones médicas, industriales, residenciales, sistemas de alarma y equipos de pruebas).

## Selección de la ubicación

El sistema se ha diseñado para funcionar en un entorno normal de oficinas. Seleccione una ubicación que esté:

- Limpia, seca y libre de macropartículas en suspensión en el aire (que no sean el polvo habitual de la habitación).
- Bien ventilada y alejada de fuentes de calor, incluida la luz solar directa y los radiadores.
- Alejada de fuentes de vibración o de golpes físicos.
- Aislada de campos electromagnéticos producidos por dispositivos eléctricos.
- En zonas propensas a tormentas eléctricas, se recomienda que conecte el servidor a un supresor de sobretensiones y desconecte las líneas de telecomunicaciones al módem durante una tormenta eléctrica.
- Provista de una toma de corriente alterna correctamente conectada a tierra.
- Provista de espacio suficiente para acceder a los cables de la fuente de alimentación ya que constituyen la desconexión principal de la alimentación.

## Manipulación del equipo

Reduzca el riesgo de daños personales o en el equipo:

- Respete los requisitos de sanidad y seguridad laborales de su país cuando traslade y levante el equipo.
- Utilice medios mecánicos u otros que sean adecuados al trasladar o levantar el equipo.
- Para que el peso sea menor para manipularlo con más facilidad, extraiga los componentes que sean de fácil extracción.

## Advertencias de alimentación y eléctricas

**Precaución:** El botón de encendido, indicado con la marca del modo de reposo o stand-by, NO DESCONECTA completamente la alimentación de CA del sistema, ya que el modo de reposo de 5 V sigue activo mientras el sistema está enchufado. Para desconectar el sistema debe desenchufar el cable de alimentación de CA de la toma de la pared. Puede usar más de un cable de alimentación de CA con el sistema. Asegúrese de que todos los cables de alimentación de CA están desenchufados. Asegúrese de que los cables de alimentación de CA estén desenchufado antes de abrir el gabinete, agregar o extraer cualquier componente que no es de conexión en funcionamiento.

Algunas fuentes de alimentación de electricidad de los servidores de Intel utilizan el polo neutral del fuselaje. Para evitar riesgos de choques eléctricos use precauciones al trabajar con las fuentes de alimentación que utilizan el polo neutral de fuselaje.

No intente modificar ni utilizar un cable de alimentación de CA si no es del tipo exacto requerido. Se necesita un cable de CA para cada fuente de alimentación del sistema.

La fuente de alimentación de este producto no contiene piezas que puedan ser reparadas por el usuario. No abra la fuente de alimentación. Dentro de la fuente de alimentación puede haber niveles de tensión, corriente y energía peligrosos. Devuélvala al fabricante para repararla.

Al reemplazar una fuente de alimentación de conexión en funcionamiento, desenchufe el cable de alimentación de la fuente de alimentación que va a reemplazar antes de extraerla del servidor.

Para evitar el riesgo de descargas eléctricas, antes de abrir el servidor, apáguelo, desconecte el cable de alimentación, los sistemas de telecomunicaciones, las redes y los módems conectados al mismo.

## Advertencias sobre el cable de alimentación

Si no se ha proporcionado con el producto ningún cable de alimentación de CA, adquiera alguno cuyo uso esté aprobado en su país.

**Precaución:** Para evitar descargas eléctricas o fuego, revise los cables de alimentación que usará con el producto tal y como se describe a continuación:

- No intente modificar ni utilizar los cables de alimentación de CA si no son exactamente del modelo especificado para ajustarse a las tomas de corriente conectadas a tierra
- Los cables de alimentación deben reunir los siguientes requisitos:
- El cable de alimentación debe disponer de una capacidad nominal de corriente eléctrica mayor que la capacidad especificada en el producto.
- El cable de alimentación debe disponer de una patilla o contacto de conexión a tierra que sea apto para la toma de corriente.
- Los cables de la fuente de alimentación son los dispositivos de desconexión principales a la corriente alterna. El enchufe o enchufes de zócalo deben encontrarse cerca del equipo y el acceso a ellos debe poderse efectuar de forma inmediata con el fin de desconectarlos.

- Los cables de la fuente de alimentación deben estar conectados a los enchufes con una toma de tierra adecuada.

## Advertencias el acceso al sistema

**Precaución:** Para evitar lesiones personales o daños en la propiedad, se aplican las siguientes instrucciones de seguridad siempre que se acceda al interior del producto:

- Apague todos los dispositivos periféricos conectados a este producto.
- Pulse el botón de alimentación para apagar el sistema.
- Desconecte la alimentación de CA desenchufando los cables de alimentación de CA del sistema o de la toma de corriente alterna.
- Desconecte todos los cables y líneas de telecomunicación que estén conectados al sistema.
- Guarde todos los tornillos o elementos de fijación cuando retire las cubiertas de acceso. Cuando termine de operar en el interior del producto, vuelva a colocar los tornillos o los elementos de fijación originales de la cubierta de acceso.
- No acceda al interior de la fuente de alimentación. No hay elementos en la fuente de alimentación que usted pueda reparar y utilizar. Devuélvala al fabricante para repararla.
- Apague el servidor y desconecte todos los cables de alimentación antes de agregar o reemplazar cualquier componente que no es de conexión en funcionamiento.
- Al reemplazar una fuente de alimentación de conexión en funcionamiento, desenchufe el cable de alimentación de la fuente de alimentación que va a reemplazar antes de extraerla del servidor.

**Precaución:** Si el servidor se ha estado ejecutando, los procesadores y disipadores de calor estarán recalentados. A no ser que esté instalando o extrayendo un componente de conexión en funcionamiento, deje que el sistema se enfríe antes de abrir las cubiertas. Para que no llegue a tocar los componentes que estén calientes cuando esté realizando una instalación de conexión en funcionamiento, tenga cuidado al extraer o instalar los componentes de conexión en funcionamiento.

**Precaución:** Para evitar posibles daños, no toque las aspas en movimiento de los ventiladores. Si el sistema se le ha suministrado con una protección para el ventilador, asegúrese de que cuando esté funcionando el sistema la protección esté en su sitio.

## Advertencias sobre el montaje en rack

El rack para el equipo se debe sujetar con un soporte fijo para evitar que se caiga cuando se extraiga un servidor o una pieza del mismo. El rack debe instalarse siguiendo las instrucciones del fabricante del bastidor.

Instale el equipo en el rack comenzando desde la parte de abajo, con el equipo más pesado en la parte inferior del rack.

Extraiga las piezas del equipo del rack de una a una.

El usuario es el responsable de la instalación de un dispositivo de desconexión de la alimentación principal para toda la unidad del rack. El acceso a este dispositivo de desconexión deberá ser de fácil acceso y deberán incluirse indicaciones que lo identifiquen como el control de alimentación eléctrica de toda la unidad, no sólo de los servidores.

Para evitar el riesgo de descargas eléctricas, deberá instalar una conexión a tierra apropiada para el rack y para cada pieza del equipo instalada en el mismo.

## Descarga electrostática (ESD)

**Precaución:** *Las descargas electrostáticas pueden dañar las unidades de disco, las tarjetas y otros componentes. Recomendamos que realice todos los procedimientos en una estación de trabajo protegida contra descargas electrostáticas. En caso de que no haya una disponible, protéjase de alguna forma contra las descargas llevando un brazalete antiestático conectado a la toma de tierra de la carcasa (cualquier superficie de metal que no esté pintada) del servidor cuando manipule las piezas.*

*Manipule siempre las tarjetas con el máximo cuidado. Pueden ser sumamente sensibles a las descargas electrostáticas. Sujételas sólo por los bordes. Una vez extraída la tarjeta de su envoltorio de protección o del servidor, colóquela con el lado de los componentes hacia arriba sobre una superficie con toma de tierra y sin carga estática. Utilice una almohadilla de espuma conductora si dispone de ella, pero nunca el envoltorio de la tarjeta. No deslice la tarjeta sobre ninguna superficie.*



## Sustitución de la batería

**Precaución:** Existe el peligro de explosión si la batería no se reemplaza correctamente. Al reemplazar la batería, utilice sólo la batería recomendada por el fabricante del equipo.

*Deseche las baterías respetando la normativa local.*

*No intente recargar la batería.*

*No intente desmontar, pinchar o causar cualquier otro desperfecto a una batería.*

## Enfriamiento y circulación de aire

**Precaución:** El tendido de los cables debe realizarse cuidadosamente tal y como se le indica para reducir al mínimo los problemas de obstrucción de la ventilación y de refrigeración.

*Para conseguir una refrigeración y corriente de aire adecuadas, compruebe que cuando sistema esté funcionando, las cubiertas de la carcasa están instaladas. Si utiliza el sistema sin las cubiertas, podría dañar sus componentes. Para instalar las cubiertas:*

- *Compruebe primero que no ha dejado herramientas o piezas sueltas dentro del sistema.*
- *Compruebe que los cables, tarjetas adicionales y otros componentes están instalados correctamente.*
- *Sujete las cubiertas a la carcasa siguiendo las instrucciones del producto.*

## Periféricos o dispositivos láser

**Precaución:** Para evitar el riesgo de la exposición a radiaciones o de daños personales:

- *No abra la caja de ningún periférico o dispositivo láser*
- *Los periféricos o dispositivos láser no pueden ser reparados por el usuario*
- *Haga que el fabricante los repare.*

## 简体中文

### 服务器安全信息

本文档适用于 Intel® 服务器主板、Intel® 服务器机箱（基座和机架固定件）和已安装的外设。为减少人身伤害、电击、火灾以及设备损坏的危险，请在安装或维护 Intel® 服务器产品之前阅读本文档并遵循本指南中的所有警告和预防措施。





如果本文档中的信息与特定产品的随附信息或 Web 站点信息之间存在不一致，请以产品文档为准。

服务器须由合格的技术人员进行集成和维护。

必须遵守本指南的规定和服务器手册的装配指导，以确保符合现有的产品认证和审批。仅使用本指南中描述和规定的指定组件。使用其他产品 / 组件将使产品的 UL 认证和其他管理审批无效，并可能导致产品不符合销售地的产品法规。

### 安全警告与注意事项

为避免人身伤害与财产损失，安装本产品之前，请阅读以下所有安全指导和信息。下面所列的安全符号可能在整个文档中使用并可能标注于产品和 / 或产品包装之上。

<b>注意</b>	表示如果无视此“?? ?项”?????? 轻微人身伤害或财产损失的危险。
<b>警告</b>	表示如果无视此“?? ”?????? 严重人身伤害的危险。
	表示如果无视所示信息，即存在潜在的危险。
	表示如果不遵守安全指导，存在可导致严重伤害或死亡的电击危险。
	表示灼热组件或表面。
	表示请勿触摸风机叶片，否则可能致伤。
	表示拔下所有交流电线，断开交流电源

## 预期应用使用

根据评估，本产品为信息技术设备 (ITE)，可安装在办公室、学校、计算机房和类似的商业场所。本产品对于非 ITE 应用的其他产品种类和环境（如医疗、工业、住宅、报警系统和测试设备）的适用性尚有待进一步的评估。

## 场地选择

本系统专为在典型办公环境运行而设计。请选择符合以下条件的地点：

- 清洁、干燥，无气载微粒（而非一般的室内尘埃）。
- 通风良好，远离热源（包括直接日晒和散热器）。
- 远离振动源或物理震动。
- 与电气设备产生的强大电磁场隔离。
- 在易受闪电袭击的地区，我们建议将系统插入电涌抑制器并在闪电期间断开通信线路与调制解调器之间的连接。
- 提供正确接地的墙壁插座。
- 提供足够的空间，以便拿取电源供应线，因为这是本产品的主要电源断开器。

## 设备操作规范

减少人身伤害或设备受损的危险：

- 移举设备时遵守当地的职业健康与安全要求。
- 借助机械手段或其他合适的手段移举设备。
- 拆除一切易分离组件，以降低重量并方便操作。

## 电源与电气警告

### 注意事项

电源按钮（如待机电源标记所示）并不能完全关闭系统的交流电源，只要系统已接通电源，就存在 5V

待机电源。要从系统切断电源，须从墙壁电源插座中拔下交流电线。您的系统可能不止使用一根交流电线。请确保所有的交流电线都已拔下。打开机箱或增加或删除任何热插拔组件之前，确保交流电线已拔下。

若非所需的确切类型，请勿尝试修改或使用交流电线。系统的每个电源供应设备都需要一根单独的交流电线。

本产品的电源供应设备包含非用户维修部件。请勿打开电源供应设备。电源供应设备包含非常危险的电压级、电流级和能量级。请与生产商联系维修事宜。

替换热插拔电源供应设备时，请先拔下需替换的电源供应设备上的电源线，再将其从服务器上移除。

为避免电击，请在打开服务器之前，关闭服务器并断开服务器上连接的电源线、电信系统、网络和调制解调器。

## 电源线警告

如果产品未提供交流电线，请购买一根您所在国家批准使用的交流电线。

### 注意事项

为避免电击或火灾危险，请按如下所述对产品所用的电源线进行检查：

- 若非所需的符合接地插座的确切类型，请勿尝试修改或使用交流电线
- 电源线须符合以下标准：
  - 电源线的电气额定值须大于产品上标注的电流额定值。
  - 电源线须拥有适合插座的安全接地插头或触点。
- 电源线为交流电源的主要断开设备。插座须靠近设备并可随时断开。
- 电源线须插入所提供的拥有合适接地的插座。

## 系统使用警告

### 注意事项

为避免人身伤害或财产损失，无论何时检查产品内部，以下安全指导都适用：

- 关闭所有与本产品相连的外设。
- 按下电源按钮至关闭状态，关闭系统。
- 从系统或墙壁插座上拔下所有交流电线，断开交流电源。
- 断开与系统相连的所有线缆和通信线路。
- 卸除舱口盖时，保留所有螺钉及其他紧固件。完成产品内部检查之后，请用螺钉或紧固件重新固定舱口盖。
- 请勿打开电源供应设备。电源供应设备内没有可维修部件。请与生产商联系维修事宜。
- 增加或替换任何非热插拔组件之前，请关闭服务器电源并断开所有电源线。
- 替换热插拔电源供应设备时，请先拔下需替换的电源供应设备上的电源线，然后再从服务器上移除电源供应设备。

### 注意事项

如果服务器一直在运行，任何已安装的处理器和吸热设备都可能很热。除非要增加或移除热插拔组件，否则请待系统冷却后再开盖。为避免在热插拔组件安装过程中接触灼热组件，移除或安装热插拔组件时务须小心。

## 注意事项

为避免受伤，请勿触摸运转的风机叶片。如果系统的风机上配有防护装置，请勿卸下风机防护装置运行系统。

## 机架固定件警告

设备的机架须固定在稳固的支座上，以防从中安装服务器或设备时倒塌。须按照机架生产商提供的安装说明进行安装。

从下往上将设备安装在机架上，最重的设备安装在机架的最底层。

一次只从机架上安装一件设备。

您须负责安装整个机架装置的主要电源断开设备。此主要断开设备须随时可用，且须标明为控制整个装置（而不仅限于服务器）的电源。

为避免潜在的电击危险，须对机架及其上所安装的每一件设备实行正确的安全接地。

## 静电放电 (ESD)

### 注意事项

ESD 会损坏磁盘驱动器、主板及其他部件。我们建议您执行 ESD 工作站的所有步骤。如果没有 ESD

工作站，则采取一些静电放电保护措施，操作部件时，戴上与服务器上的机箱接地或任何未喷漆金属表面连接的防静电腕带。

操作主板时始终保持小心。它们可能对 ESD

非常敏感。拿持主板时只接触边缘。从保护包装中或从服务器上取出主板后，请将主板组件侧面朝上放置于无静电的接地表面上。请使用导电泡沫垫（若有），不要使用主板包装。请勿将主板在任何表面上滑动。

## 其他危险

### 替换电池

#### 注意事项

不正确替换电池可能导致爆炸危险。替换电池时，请只使用设备生产商推荐使用的电池。

请按当地法规处置电池。

请勿对电池充电。

请勿拆卸、刺穿或以其他方式损坏电池。

### 冷却和气流

#### 注意事项

按照说明小心布置线缆，尽量减少气流阻塞和冷却问题。

为保证适当的冷却和气流，运行系统时请确保机箱盖已安装。未安装机箱盖即运行系统可能导致系统部件受损。安装机箱盖的步骤如下：

- 首先检查并确保系统内没有遗留的未固定工具或部件。
- 检查线缆、内插板和其他组件已正确安装。
- 按产品说明安装机箱盖。

### 激光外设或激光设备

#### 注意事项

为避免幅射暴露和 / 或人身伤害：

- 请勿打开任何激光外设或激光设备的外壳
- 激光外设或激光设备为非用户维修设备

请与生产商联系维修事宜