

# Intel® Carrier Grade Server TIGH2U Hardware Reference Guide

Thank you for buying an Intel® Carrier Grade Server System. The following information will help you set up and install your Intel® Carrier Grade Server TIGH2U and service components.



This guide and other supporting documents are located on the web at <http://support.intel.com/support/telecom/computeboards/tigh2u>

If you are not familiar with ESD (Electrostatic Discharge) procedures used during system integration, please see the Intel® Carrier Grade Server TIGH2U Product Guide, available on the CD or at <http://support.intel.com/support/telecom/computeboards/tigh2u/>

Read all cautions and warnings first before starting your server platform integration.

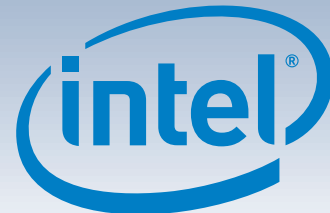

## Minimum Hardware Requirements

To avoid integration difficulties and possible board damage, your system must meet the following minimum requirements:

- Processor: Quad-Core Intel® Xeon® processor 5300 or 5400 series with compatible 2U passive heat sink.
- Memory: Minimum of one 512MB, 240-pin DDR2 533/667 MHz FB DIMM.
- Power: see the Intel® Carrier Grade Server TIGH2U Technical Product Specification.

## 1 Attaching the Ground Strap

- Remove the bezel to access the ground strap attachment point. *If the bezel is installed, see Step 2.*
- Attach ground strap to anti-static connection point.

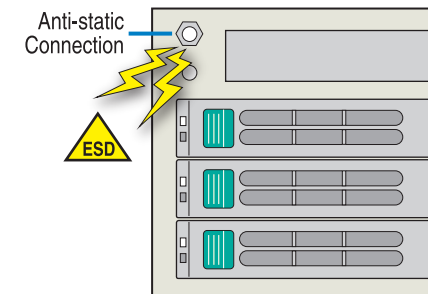

## 2 Removing the Bezel

- Loosen the captive screw to release the bezel. **A**
- Rotate the bezel outward as shown and remove. **B**

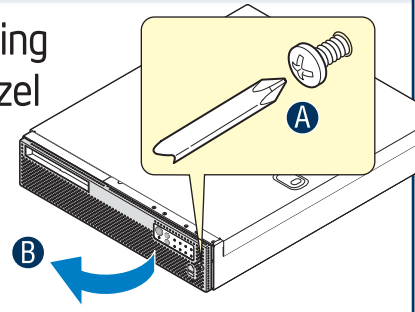

## 3 Removing Top Cover

- Remove the shipping screw. **A**
- Push blue locking button, slide cover rearward, then lift up and remove. **B**

**CAUTION:** This unit must be operated with the top cover installed to ensure proper cooling.

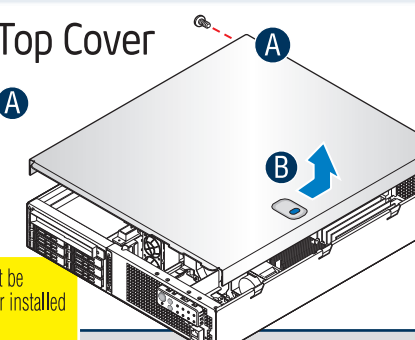

## 4 Removing the Processor Air Duct

- Loosen the blue captive fastener. **A**
- Slide the duct rearward until it stops. **B**
- Lift the duct straight up and remove. **E**

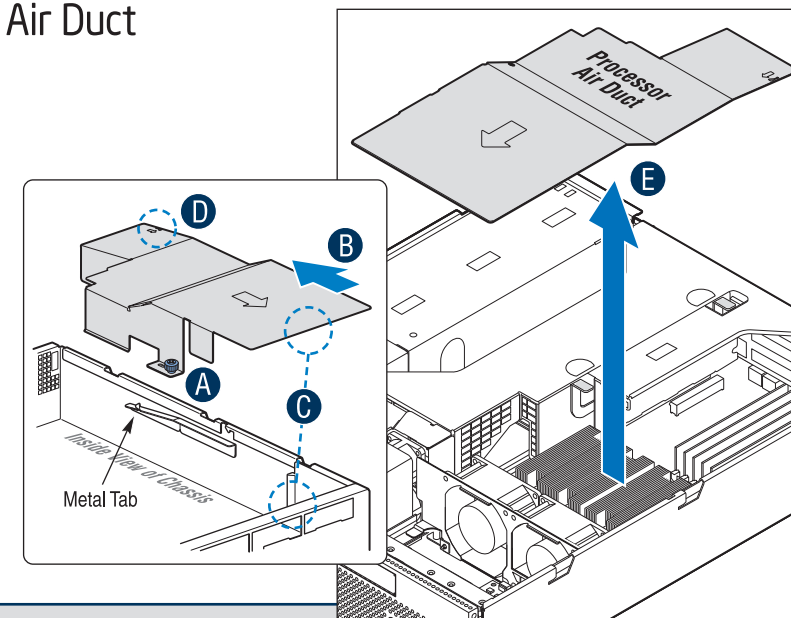

## 5 Replacing/Installing an Add-in Card

**IMPORTANT NOTE:** Before removing the PCI riser assembly, first disengage the PCI fan assembly from the card guide at the front end of the riser assembly.

### Disengage Fan Assembly

**NOTE:** The PCI fan assembly is attached to the PCI riser assembly card guide with a locking pin.

- Use the tip of your finger to push the locking pin upward and remove. **A**
- Grasp the PCI fan assembly and slide it slightly to the LEFT, then pull it away from the card guide just enough to disengage the three retention tabs. **B**

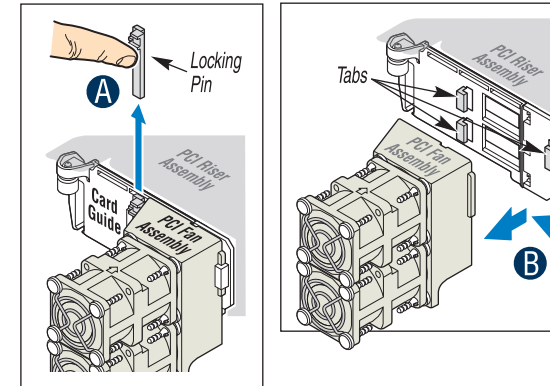

**Note:** The flex-cable is **not shown** for clarity. It is not necessary to remove the flex-cable.

**When you have completed your add-in card installation and re-installed the PCI riser assembly, return to this section to re-install the PCI fan assembly and locking pin.**

### Remove Riser Retention Plate

**NOTE:** The front of the PCI riser assembly is secured by the PCI riser retention plate. This plate must be removed **before** removing the PCI riser assembly.

- Lift and hold up the front edge of the PCI riser retention plate until it clears the PCI riser assembly. **C**
- Slide the retention plate toward the rear of the power supply to disengage the two tabs, then lift straight up and remove. **D**

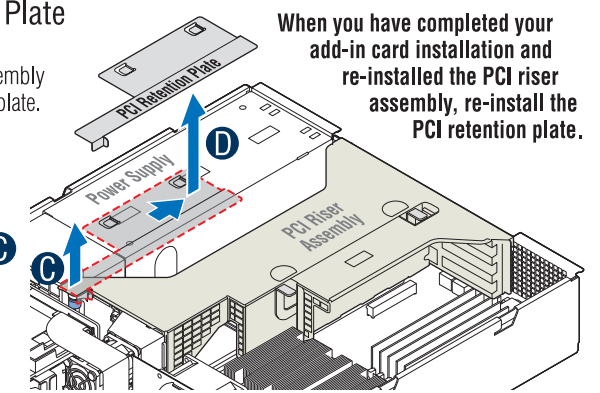

### Remove the Riser Assembly

- Grasp the PCI riser assembly by the two blue flexible handles, pull carefully upward and lift out of chassis. **E**

**Note:** the alignment "hooks" and "pins" located at the rear of riser and chassis. These will help align the riser assembly during re-installation.

**CAUTION:** Place PCI riser assembly upside-down during installation or removal of add-in cards.

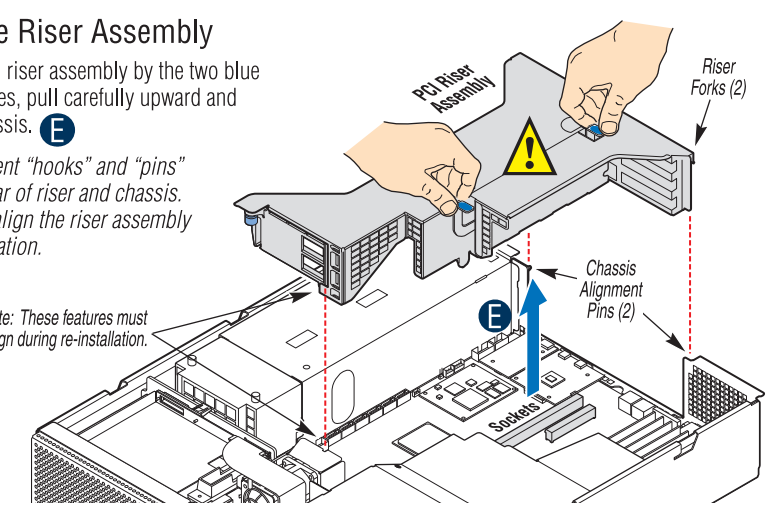

### Remove Add-in Cards

- Remove the rear retention screw securing the bracket of the add-in card to be removed. **F**
- For a full-height card, remove front add-in card retention clip by loosening the blue captive thumbscrew, rotating device outward slightly, then disengaging the three plastic tabs from the metal sidewall. For a low-profile card, skip this step and proceed to step 8. **G**
- Remove add-in card. **H**

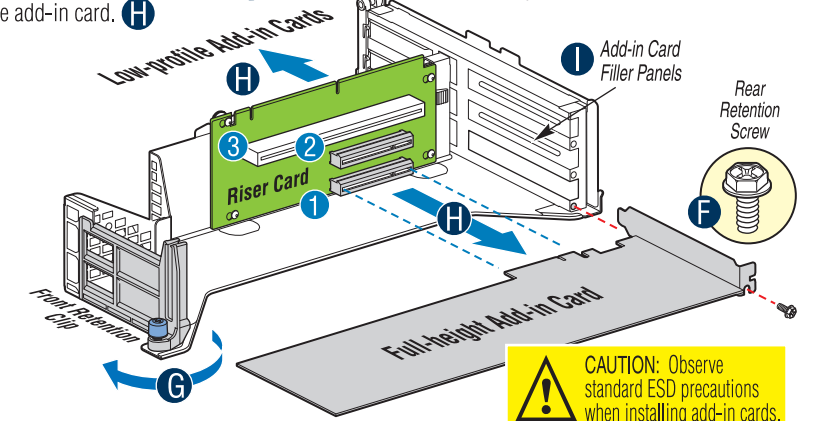
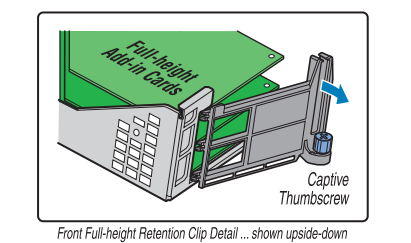

## Warning

Read all caution and safety statements in this document before performing any of the instructions. Also see the *Intel® Server Board and Server Chassis Safety Information* document at: <http://support.intel.com/support/motherboards/server/sb/cs-010770.htm> for complete safety information.

## Warning

Installation and service of this product should only be performed by qualified service personnel to avoid risk of injury from electrical shock or energy hazard.

## Caution

Observe standard ESD (Electrostatic Discharge) procedures during system integration to avoid possible damage to server boards and/or other components.

## Tools Required

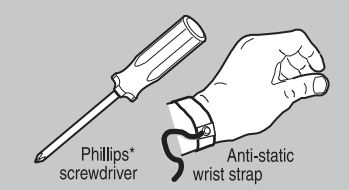

## 6 Installing the Processor(s)

**Note:** If you are only using one processor on your server board, use the socket labeled "CPU1" in the Reference Diagram.

**Caution:** When unpacking a processor, hold by the edges only to avoid touching the contacts.

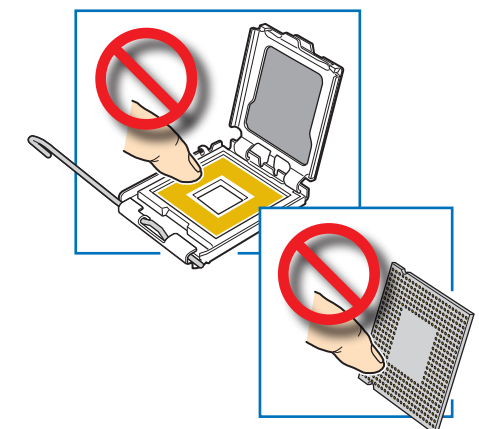

### Open the Socket Lever

- Push the lever handle down and away from the socket to release it. **A**
- Pull the lever and open all the way. **B**

### Open the Load Plate

- Push the rear tab with your finger tip to bring the front end of the load plate up slightly. **A**
- Open the load plate as shown. **B**

### Remove the Processor Protective Cover

- Take the processor out of the box and remove the protective shipping cover. **A**

### Install the Processor

- Orient the processor so that its cutouts match the socket's notches. **A**
- Gently place the processor on the socket as shown. **B**

### Remove Socket Protective Cover

- Grasp the socket protective cover tab and pull away from the load plate as shown. **A**
- Remove the socket protective cover and store for future use. **B**

### Close Load Plate and Socket Lever

- Close the load plate all the way as shown. **A**
- With your finger, push down on the load plate as shown. **B**
- Close the socket lever and ensure that the load plate tab engages under the socket lever when fully closed. **C**

## 7 Installing the Processor Heat Sink(s)

**CAUTION:** Use gloves to avoid sharp edges. The heat sink has thermal interface material (TIM) on the underside of it. Use caution so that you do not damage the thermal interface material.

- If this is a new heat sink, remove the protective film on the TIM if present. **A**
- Align heat sink fins to the front and back of the chassis for correct airflow. *Airflow goes from front-to-back of chassis.* **B**

Each heat sink has four captive fasteners that should be tightened using the following procedure:

- Using a #2 Phillips® screwdriver, loosely tighten the fasteners in the order shown in the figure; fastener #1, then the one diagonally across from it, and so on. **C**
- Securely re-tighten each fastener again in the same order as performed in Step 3.

**Note:** Heat sink styles may vary.

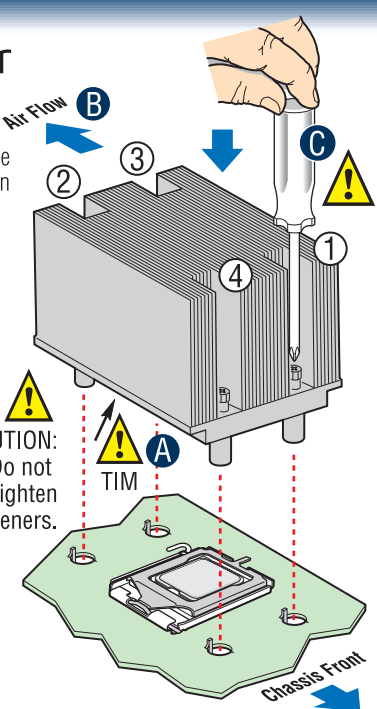

## 8 Installing Memory

**Note:** For memory installation, only use qualified DIMMs that are approved by Intel. For additional memory configuration information, see the Server Board TPS or the TIGH2U Product Guide on the resource CD or at <http://support.intel.com/support/telecom/computeboards/tigh2u>

For a list of supported memory components, see the S5000PAL Tested Memory List also at this location.

**CAUTION:** Observe standard ESD precautions when installing DIMMs.

### To Install DIMMs

- Open both DIMM socket levers. **A**
- Note location of alignment notch. **B**
- Insert DIMM making sure the connector edge of the DIMM aligns correctly with the slot. **C**
- Using both hands, press down evenly and firmly on both sides of the DIMM until it snaps into place and the levers close. **D**

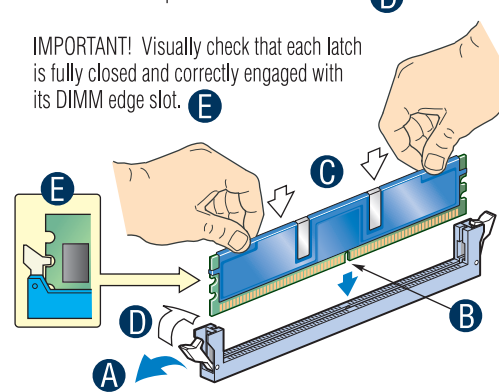

## 9 Replacing a Power Supply Module

**IMPORTANT NOTES:** To maintain hot-swap capability, make sure that an active power supply module is in BOTH chassis slots before replacing (hot-swapping) a power supply module. Check the status LED to determine which PS module has failed ... (see detail at right).

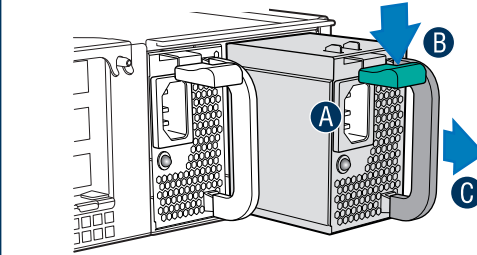
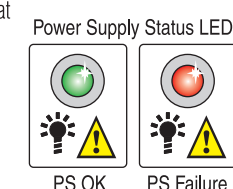

- Disconnect appropriate power cord. **A**
- Press green safety lock downward and hold. **B**
- Grasp handle and pull module out. **C**
- To insert a new power supply, press and hold the green safety lock downward and slide the power supply module into the chassis slot.

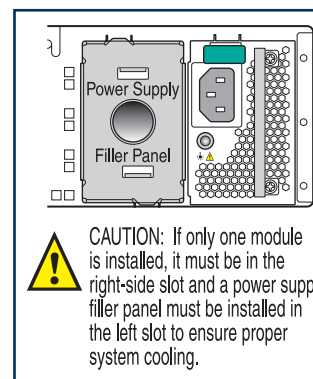

**CAUTION:** If only one module is installed, it must be in the right-side slot and a power supply filler panel must be installed in the left slot to ensure proper system cooling.

### Install Add-in Card

- If the add-in card slot was empty, push out the add-in card filler panel, **I** then reverse the previous steps to complete installation of an add-in card.

### Install PCI Riser Assembly

- Ensure that the forks at rear of PCI riser assembly engage matching pins on chassis back panel. **J**
- Position riser card edge connectors over the server board riser sockets. **K**
- Press down uniformly until the two hooks and two pins engage. The riser cards will seat into the matching sockets on the server board. **L**

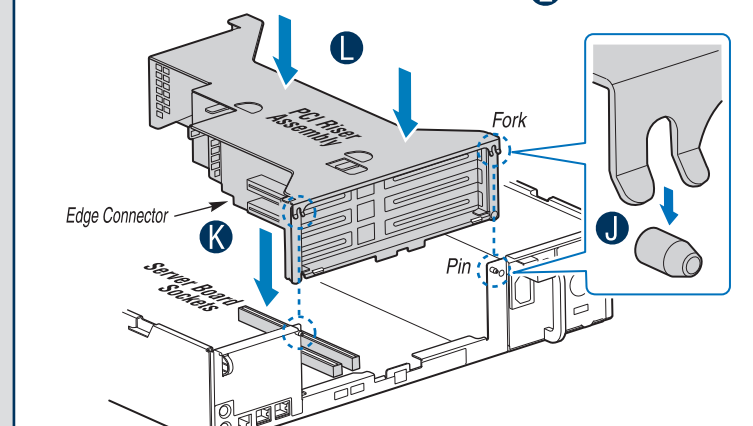

E15526-003



Intel, the Intel logo, Xeon, and Xeon Inside are trademarks of Intel Corporation in the U.S. and other countries. \*Other names and brands may be claimed as the property of others. Copyright © 2008, Intel Corporation. All rights reserved.