Copyright and Warranty Notice

The information in this document is subject to change without notice and does not represent a commitment on part of the vendor, who assumes no liability or responsibility for any errors that may appear in this manual.

No warranty or representation, either expressed or implied, is made with respect to the quality, accuracy or fitness for any particular part of this document. In no event shall the manufacturer be liable for direct, indirect, special, incidental or consequential damages arising from any defect or error in this manual or product.

Product names appearing in this manual are for identification purpose only and trademarks and product names or brand names appearing in this document are the property of their respective owners.

This document contains materials protected under International Copyright Laws. All rights reserved. No part of this manual may be reproduced, transmitted or transcribed without the expressed written permission of the manufacturer and authors of this manual.

If you do not properly set the motherboard settings, causing the motherboard to malfunction or fail, we cannot guarantee any responsibility.

SA6/SA6R Motherboard User's Manual

Index

CHAPTER 1. INTRODUCTION OF SA6/SA6R FEATURES	1-1
1-1. FEATURES OF THIS MOTHERBOARD	1-1
1-2. SPECIFICATIONS.....	1-2
1-3. PACKAGE LIST.....	1-3
1-4. LAYOUT DIAGRAM	1-4
CHAPTER 2. INSTALLING THE MOTHERBOARD.....	2-1
2-1. INSTALLING THE MOTHERBOARD TO THE CHASSIS	2-1
2-2. THE INSTALLATION OF CPU	2-2
2-3. INSTALLING SYSTEM MEMORY	2-3
2-4. CONNECTORS, HEADERS AND SWITCHES.....	2-5
CHAPTER 3. INTRODUCING THE BIOS.....	3-1
3-1. CPU SETUP [SOFT MENU™ III].....	3-3
3-2. STANDARD CMOS FEATURES SETUP MENU	3-6
3-3. ADVANCED BIOS FEATURES SETUP MENU.....	3-9
3-4. ADVANCED CHIPSET FEATURES SETUP MENU	3-12
3-5. INTEGRATED PERIPHERALS	3-14
3-6. POWER MANAGEMENT SETUP MENU	3-18
3-7. PNP/PCI CONFIGURATIONS	3-24
3-8. PC HEALTH STATUS.....	3-27
3-9. LOAD FAIL-SAFE DEFAULTS	3-28
3-10. LOAD OPTIMIZED DEFAULTS	3-28
3-11. SET PASSWORD.....	3-29
3-12. SAVE & EXIT SETUP.....	3-30
3-13. EXIT WITHOUT SAVING	3-30
CHAPTER 4. RAID SETTING GUIDE (FOR SA6R ONLY)	4-1
4-1. THE FEATURES OF RAID ON THE SA6R.....	4-1
4-2. SETUP RAID ON THE SA6R.....	4-1
4-3. THE BIOS SETTING MENU	4-2
CHAPTER 5. HPT370 SOFTWARE INSTALLATION (FOR SA6R ONLY)	5-1
5-1. DOS® INSTALLATION	5-1
5-2. WINDOWS® 9X INSTALLATION	5-1
5-3. WINDOWS NT® 4.0 INSTALLATION	5-5
5-4. WINDOWS® 2000 INSTALLATION	5-8
5-5. HPT370 UTILITY INSTALLATION GUIDE	5-10

-
-
- APPENDIX A. INSTALLING THE INF UTILITY FOR WINDOWS® 98 SE***
- APPENDIX B. INSTALLING THE AUDIO DRIVER FOR WINDOWS® 98 SE***
- APPENDIX C. INSTALLING THE ATA UTILITY FOR WINDOWS® 98 SE***
- APPENDIX D. INSTALLING THE AUDIO DRIVER FOR WINDOWS® NT 4.0
SERVER/WORKSTATION***
- APPENDIX E. INSTALLING THE ATA UTILITY FOR WINDOWS® NT 4.0
SERVER/WORKSTATION***
- APPENDIX F. INSTALLING THE INF UTILITY FOR WINDOWS® 2000***
- APPENDIX G. INSTALLING THE AUDIO DRIVER FOR WINDOWS® 2000***
- APPENDIX H. INSTALLAING THE ATA UTILITY FOR WINDOWS® 2000***
- APPENDIX I. BIOS UPDATE GUIDE***
- APPENDIX J. HARDWARE MONITORING FUNCTION (INSTALLING THE
WINBOND HARDWARE DOCTOR UTILITY)***
- APPENDIX K. INSTALLATION GUIDE FOR SUSPEND TO RAM***
- APPENDIX L. TROUBLESHOOTING (NEED ASSISTANCE?)***
- APPENDIX M. HOW TO GET TECHNICAL SUPPORT***

Chapter 1. Introduction of SA6/SA6R Features

1-1. Features of This Motherboard

The SA6/SA6R motherboard is designed for use with Intel Pentium® II & III Processors, which utilize the FC-PGA (Flip-Chip Pin Grid Array), 370-pin design. Up to 512MB of memory can be supported.

The SA6/SA6R uses the new Intel 815EP chipset. Its 133MHz capable memory interface supports the wide range of PC 133 memory devices now on the market. Its 133MHz capable front-side bus delivers a clear upgrade path to the future generation of 133MHz processors.

The SA6/SA6R includes an Ultra ATA/100 controller chip that can provide speedier HDD throughput to boost overall system performance. Ultra ATA/100, or Ultra DMA/100, is an extension of the current Ultra ATA/66 interface. This new high-speed interface has a 100 Mbytes/sec transfer rate and maximized disk performance under the current PCI local bus environment.

For SA6R: The onboard HPT370 RAID controller chip provides two extra IDE channels (IDE3 and IDE4) that support Ultra ATA/100 specifications, allowing your system to connect up to eight IDE devices (IDE1 ~ IDE4) in total. It also offers the ability to use RAID 0 (striping), RAID 1 (mirroring), and RAID 0+1 (striping + mirroring). The RAID 0 array is designed for performance. By using two hard disks, the information can be split evenly between the two, effectively doubling performance. By setting a RAID 1 array, you are automatically backing up all data. RAID 1 is a mirroring setup that writes the data to both hard disks whenever saving to hard disk. RAID 0+1 gives the user the performance of RAID 0 and the security of RAID 1. Complete with all required components, such as two UDMA/66 compatible cables as well as drivers, the SA6R now makes RAID arrays easy to setup.

With 2 USB ports as well as capability of expanding to 4 USB slots, the SA6/SA6R meets future USB demands. A Communication/Network Riser Slot (CNR Slot) is found on the SA6/SA6R. The CNR Slot provides audio, modem and network connectivity. The specification's main objective is to reduce the cost of audio and modem functionality.

The SA6/SA6R has built-in hardware monitoring functions. The Winbond Hardware Doctor protects PC hardware by monitoring several critical items including power supply voltages, CPU & system fan speeds, and CPU and system temperatures. In order to provide accurate hardware temperature monitoring with the Hardware Doctor, the SA6/SA6R is capable of equipping with an optional thermal sensor cable to assure you the most latitude in designing your hardware monitoring.

The SA6/SA6R implements SoftMenu™ III technology that allows you to install or upgrade your own CPUs easily. The SA6/SA6R BIOS supports a wide range of external clock settings, multipliers from 2 to 12, special multifunction PCI and AGP clock dividers, and front side bus speeds from 50~250MHz.

This motherboard provides high performance for servers while also meeting the requirements for desktop systems, both now and into the future.

1-2. Specifications

1. CPU

- Supports Intel Pentium® II/III up to 1GHz processors cartridge based on 100 & 133MHz FSB
- Supports Intel Celeron® up to 766MHz processors cartridge based on 66MHz FSB
- Reserves support for future Intel Pentium® III/Celeron® socket processors

2. Chipset

- Intel 815EP (ICH2) chipset
- Supports 66/100/133MHz (Front Side Bus)
- Supports AGP 1X/2X/4X (Sideband) 1.5V/3.3V device
- Supports Advanced Configuration and Power Management Interface (ACPI)
- Supports Ultra ATA/100, Ultra ATA/66, and Ultra ATA/33 mode

3. Ultra DMA 100/RAID (For SA6R Only)

- High Point HPT370 IDE controller
- Supports Ultra DMA 100MB/sec data transfer rate
- Supports RAID0 (Stripping mode for boosting performance) mode
- Supports RAID1 (Mirroring mode for data security) mode
- Supports RAID 0+1 (Stripping and Mirroring) mode

4. Memory

- Four 168-pin DIMM sockets support SDRAM module
- Supports up to 512MB Max.
- Supports 100MHz, 133MHz SDRAM interface

5. Audio

- AC'97 Digital Audio controller integrated
- AC'97 2-channel Audio CODEC on board

6. System BIOS

- SOFT MENU™ III technology and DIP switches function
- Award Plug and Play BIOS supports APM and ACPI
- Write-Protect Anti-Virus function by AWARD BIOS

7. Multi I/O Functions

- 2 Channels of Bus Master IDE Ports supporting Ultra DMA 33/66/100 (For SA6)
- 4 Channels of Bus Master IDE Ports supporting Ultra DMA 33/66/100 (For SA6R)
- PS/2 Keyboard and PS/2 Mouse connectors
- 1x Floppy Port (up to 2.88MB)
- 1x Parallel Port (EPP/ECP)
- 2x Serial Ports
- 2 port USB connectors
- On board USB header for two extra USB channels
- Audio connector (Line-in, Line-out, Mic-in, and Game Port)

8. Miscellaneous

- Support STR (Suspend to DRAM)
- ATX form factor
- 1 universal AGP slot, 6 PCI slots and 1 CNR slot
- Hardware Monitoring – including fan speed, voltages, CPU and system temperature and one thermal header for other devices temperature monitoring
- Keyboard and Mouse Power On

- Built-in Wake-On-LAN/Wake-On-Modem/Open Chassis header
- Built-in IrDA TX/RX header
- * **Supports Wake-On-LAN, Modem, but your ATX power supply 5V standby power must be able to provide at least a 720mA current capacity. Otherwise, the functions may not work normally.**
- * **The 66MHz/100MHz/133MHz standard bus speeds are supported but exceeding the standard bus speeds is not guaranteed due to the PCI, processor and chipset specifications.**
- * **Specifications and information contained in this manual are subject to change without notice.**

Note

All brand names and trademarks are the property of their respective owners.

1-3. Package List

Check the following list. If there is any item damaged or missing, please contact your local dealer.

- (1) SA6 or SA6R Motherboard
- (1) Ribbon cable for master and slave Ultra DMA/66/100 IDE drives (For SA6)
- (2) Ribbon cable for master and slave Ultra DMA/66/100 IDE drives (For SA6R)
- (1) Ribbon cable for floppy disk drives
- (1) USB expansion cable
- (1) SA6/SA6R CD-Title
- (1) This User's Manual
- Thermal Cable (optional)

1-4. Layout Diagram

* Red mark indicates pin 1 location.

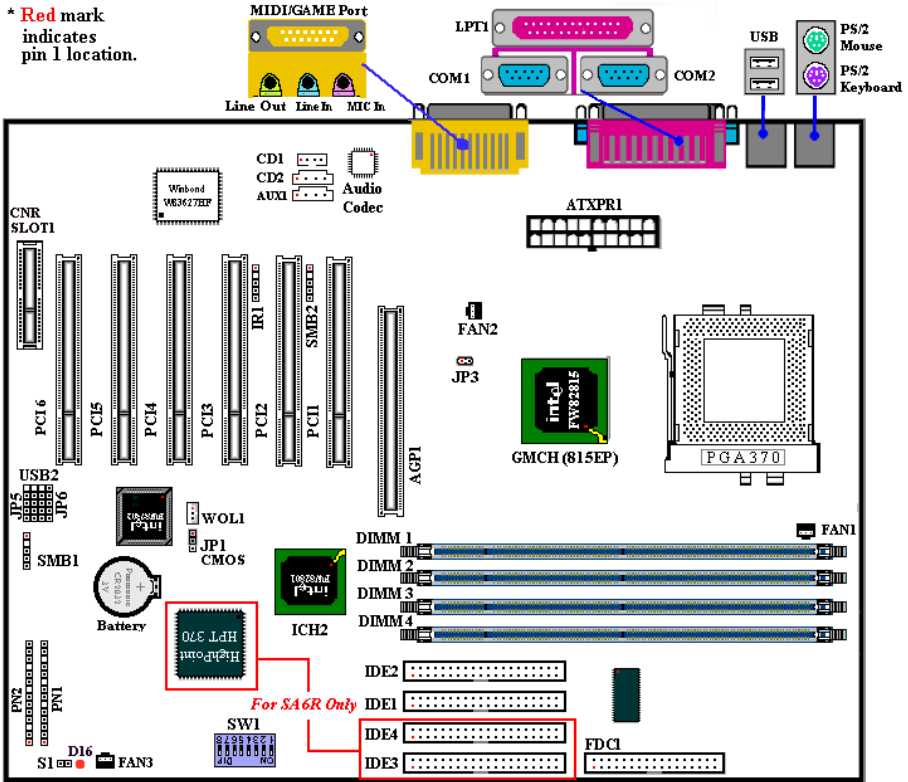

Figure 1-1. SA6/SA6R Motherboard component location

Chapter 2. Installing the Motherboard

This SA6/SA6R motherboard not only provides all standard equipment for classic personal computers, but also provides great flexibility for meeting future upgrade demands. This chapter will introduce step by step all of the standard equipment and will also present, as completely as possible, future upgrade capabilities. This motherboard is able to support Intel® Pentium® III and Celeron processors now on the market. (For details, see specifications in Chapter 1.)

This chapter is organized according the following features:

2-1 Installing the Motherboard to the Chassis

2-2 The Installation of CPU

2-3 Installing System Memory

2-4 Connectors, Headers and Switches



Before Proceeding with the Installation



Before you install or unplug any connectors or add-on cards, please remember to turn the ATX power supply switch off (fully turn the +5V standby power off), or disconnect the power cord. Otherwise, you may cause the motherboard components or add-on cards to malfunction or be damaged.

User Friendly Instructions

Our objective is to enable the novice computer users to perform the installation by themselves. We have attempted to write this document in a very clear, concise and descriptive manner to help overcome any obstacles you may face during installation. Please read our instructions carefully and follow them step-by-step.

2-1. Installing the Motherboard to the Chassis

Most computer chassis will have a base on which there will be many mounting holes that allows the motherboard to be securely attached and at the same time, prevents short circuits. There are two ways to attach the motherboard to the base of chassis:

- with studs
- or with spacers

Figure 2-1 shows the shape of studs and spacers. There may be several types, but all look similar.

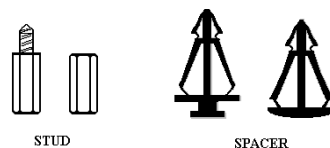

Figure 2-1. The outline of stub and spacer

In principle, the best way to attach the motherboard is with studs. Only if you are unable to do this should you attach the board with spacers. Take a careful look at the motherboard and you will see many mounting holes on it. Line these holes up with the mounting holes on the base. If the holes line up and there are screw holes this means you can attach the motherboard with studs. If the holes line up and there are only slots, this means you can only attach the motherboard with spacers. Take the tip of the spacers and insert them into the slots. After doing this to all the slots, you can slide the motherboard into position aligned with the

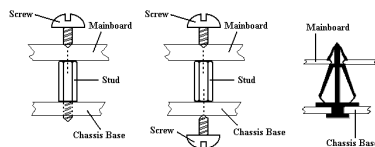

Figure 2-2. The way we fixed the motherboard

slots. After the motherboard has been positioned, check to make sure everything is OK before putting the casing back on. Figure 2-2 shows you the way to affix the motherboard using studs or spacers.

Note

If the motherboard has mounting holes, but they don't line up with the holes on the base and there are no slots to attach the spacers, do not despair; you can still attach the spacers to the mounting holes. Just cut the bottom portion of the spacers (the spacers may be a little hard to cut, so mind your fingers). In this way, you can still attach the motherboard to the base without worrying about short circuits. Sometimes you may need to use the plastic springs to isolate the screw from the motherboard PCB surface as the circuit wire may be too near the hole. Be careful. Do not let the screw contact the printed circuit wire or parts on the PCB that are near the fixing hole. Otherwise it may damage the board or cause board malfunctioning.

2-2. The Installation of CPU

The Intel® Celeron™ (PPGA & FC-PGA) & Pentium® III (FC-PGA) package processor installation, is easy, like Socket 7 Pentium® processors before. Because it uses the "Socket 370" ZIF (Zero Insertion Force) socket, it lets you easily fix the processor on to its position firmly. Figure 2-3 shows you what the 370 socket looks like, and how to open the lever. Its pin count is more than socket 7. Therefore, a Pentium level processor cannot be inserted into socket 370.

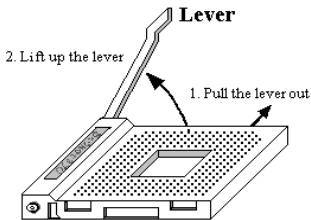

Figure 2-3. Socket 370 and open its lever

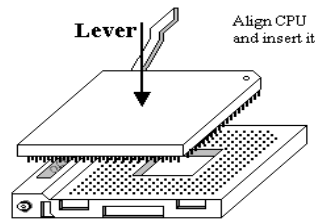

Figure 2-4. Install the CPU into socket 370

When you raise the lever, you have to loosen the socket lock. Please raise the lever to the end, and prepare to insert the processor. Next, you need to align the processor pin 1 to the socket pin 1. If you put it in the wrong direction, you will not be able to insert the processor easily, and processor pins will not fully go into the socket. If that is the case, please change the direction, until it easily and fully inserts into the socket 370. See Figure 2-4.

When you finish the above, push the lever down to its original position, and you should feel the lever lock up the socket 370. You have then finished the processor installation.

Note

Installing a heat sink and cooling fan is necessary for proper heat dissipation from your CPU. Failing to install these items may result in overheating and damage of your CPU. Please refer to your boxed processor installation or other documentation attached with your CPU for detailed installing instructions.

2-3. Installing System Memory

This motherboard provides four 168-pin DIMM sites for memory expansion available from minimum memory size of 32MB to maximum memory size of 512MB SDRAM.

In order to create a memory array, certain rules must be followed. The following set of rules allows for optimum configurations.

- The memory array is 64 or 72 bits wide. (Depending on with or without parity)
- Those modules can be populated in any order
- Supports single and double density DIMMS

Table 2-1. Valid Memory Configurations

Bank	Memory Module	Total Memory
Bank 0, 1 (DIMM1)	32, 64, 128, 256MB	32MB ~ 256MB
Bank 2, 3 (DIMM2)	32, 64, 128, 256MB	32MB ~ 256MB
Bank 4, 5 (DIMM3)	32, 64, 128, 256MB	32MB ~ 256MB
Bank 4, 5 (DIMM4)	32, 64, 128, 256MB	32MB ~ 256MB
Total System Memory		32MB ~ 512MB

Note

- The Solano series motherboard does not support the memory modules of 4-bit width.
- Please follow the order of DIMM1~DIMM4 to install the RAM module. A disregarded order may cause the system not booting or the BIOS cannot detect the memory you had installed.
- As the DIMM3 and DIMM4 share the same bank of 4 and 5, please do not install those RAM modules that will occupy two banks into these two slots simultaneously. Check the RAM modules from its manufacturer for more detail.

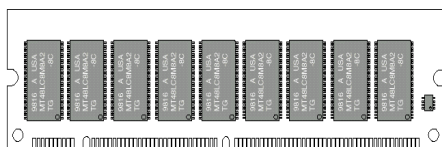

Figure 2-5 PC100/PC133 Module and Component Mark

Generally, installing SDRAM modules to your motherboard is an easy thing to do. You can refer to figure 2-5 to see what a 168-pin PC100 & PC133 SDRAM module looks like.

DIMMs may be “snapped” directly into the socket. Note: Certain DIMM sockets have minor physical differences. If your module doesn't seem to fit, please do not force it into the socket as you may damage your memory module or DIMM socket.

The following procedure will show you how to install a DIMM module into a DIMM socket.

Step 1. Before you install the memory module, please place the computer power switch in the “OFF” position and disconnect the AC power cord.

Step 2. Remove the computer’s chassis cover.

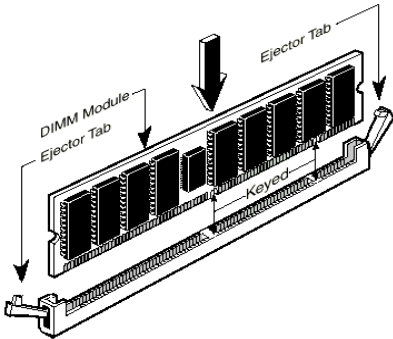

Figure 2-6. Memory module installation

Step 3. Before touching any electronic components, make sure you first touch an unpainted, grounded metal object to discharge any static electricity stored on your clothing or body.

Step 4. Locate your computer's 168-pin memory expansion DIMM socket.

Step 5. Insert the DIMM module into the expansion socket as shown in the illustration. Note how the module is keyed to the socket. You can refer to figure 2-6 for the details. *This insures the DIMM module will be plugged into the socket in one way only.* Firmly press the DIMM module into the DIMM socket, making certain the module is completely seated in the DIMM socket.

Step 6. Once the DIMM module has been installed, the installation is complete and the computer's cover can be replaced. Or you can continue to install other devices and add-on cards that are mentioned in the following section.

Note

When you install a DIMM module fully into the DIMM socket, the eject tab should be locked into the DIMM module very firmly and fit into its indentation on both sides.

It is difficult to differentiate between the PC100, PC133 SDRAM and VCM DRAM modules from the exterior. The only way to identify them is through the sticker on the RAM module.

2-4. Connectors, Headers and Switches

Inside the case of any computer several cables and plugs have to be connected. These cables and plugs are usually connected one-by-one to connectors located on the motherboard. You need to carefully pay attention to any connection orientation the cables may have and, if any, notice the position of the first pin of the connector. In the explanations that follow, we will describe the significance of the first pin.

We will show you all of the connectors, headers and switches here, and tell you how to connect them. Please pay attention and read the entire section for necessary information before attempting to finish all of the hardware installation inside the computer chassis.

Figure 2-7 shows you all of the connectors and headers that we'll discuss in the next section, you can use this diagram to visually locate each connector and header we describe.

All connectors, headers and switches mentioned here will depend upon your system configuration. Some features you may (or may not) have and need to connect or configure depending on the peripheral. If your system doesn't have such add-on cards or switches you can ignore some special feature connectors.

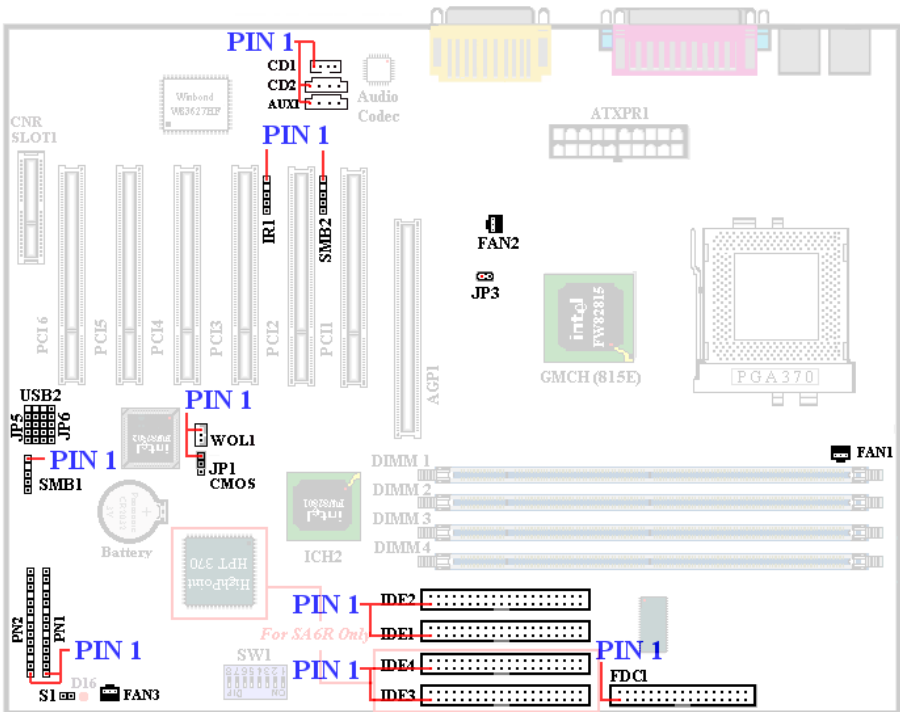

Figure 2-7. All Connectors and Headers for the SA6/SA6R

First, let's look at the headers that the SA6/SA6R uses, and what their functions are.

(1). ATXPR1: ATX Power Input Connector

Caution

If the power supply connectors are not properly attached to the ATXPR1 power supply, the power supply or add-on cards may be damaged.

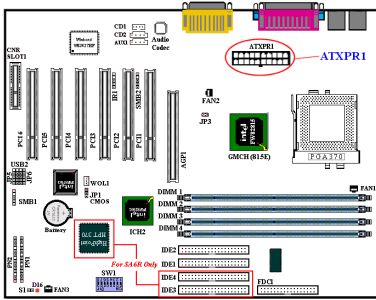

Attach the connector from the power supply to the ATXPR1 connector here. Remember you have to push the connector from the ATX power supply firmly into the ATXPR1 connector, ensuring that you have a good connection.

Note: Watch the pin position and the orientation

(2). FAN1, FAN2 & FAN3 header

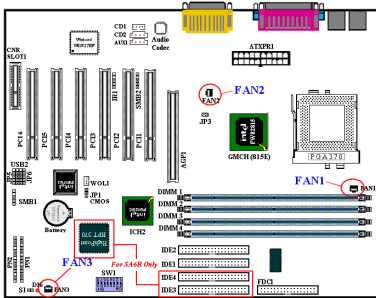

Attach the connector from the individual CPU fan to the header named FAN1. The connector from the chassis fan should be attached to the header FAN3 and the connector from the power fan to FAN2.

You must attach the CPU fan to the processor or your processor will work abnormally or may be damaged by overheating. To keep the computer's internal temperature steady and not too high, connecting the chassis fan is imperative.

Note: Watch the pin position and the orientation

(3). IR1: IR Header (Infrared)

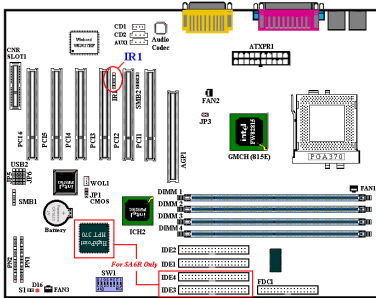

There is a specific orientation for pins 1 through 5, attach the connector from the IR KIT or IR device to the IR1 header (left row only). This motherboard supports standard IR transfer rates.

Note: Watch the pin position and the orientation

(4). WOL1: Wake on LAN Header

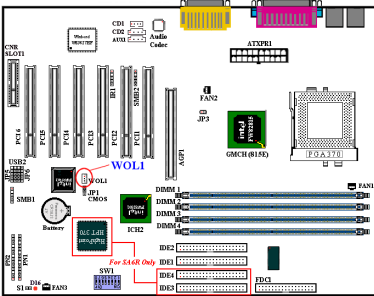

If you have a network adapter that supports this feature, then you can connect the specific cable from the network adapter to this header. This feature lets you wake up your computer via remote control through a local area network. You may need a specific utility to control the wake up event, such as the PCnet Magic Packet utility or other similar utilities.

Note: Watch the pin position and the orientation

(5). CNR Slot: Communication Network Riser Slot

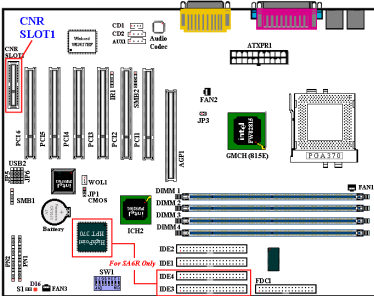

This slot is used for an optional CNR with the main objective of reducing the baseline implementation cost of features that are widely used in the “Connected PC”, while also addressing specific functional limitations of today’s audio, modem, and LAN subsystems.

(6). SMB1 & SMB2 Header: System Management Bus Connector

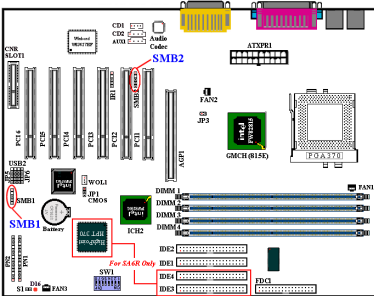

This header is reserved for system management bus (SM bus). The SM bus is a specific implementation of an I²C bus. I²C is a multi-master bus, which means that multiple chips can be connected to the same bus and each one can act as a master by initiating a data transfer. If more than one master simultaneously tries to control the bus, an arbitration procedure decides which master gets priority.

Note: Watch the pin position and the orientation.

(7). JP3 Header (RT2 Thermistor):

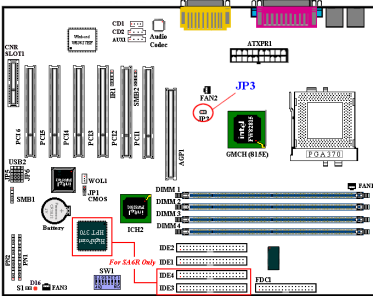

This header is a thermistor connector used for detecting the system environmental temperature. It may also be called a system temperature detector. You can attach one end of the two-threaded thermal cable (optional) to the JP3 header, then tape the other end of the thermal cable onto the CPU’s heat sink. Generally speaking, the location you tape the thermistor should be as near the CPU chipset as possible and avoid having it near the CPU fan.

(8). USB2/JP5/6 Headers: Additional USB Plugs:

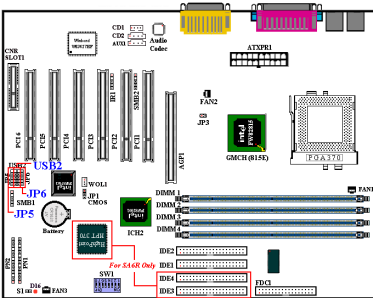

These headers are used for connecting the additional USB ports plug. You can have two additional USB plugs affixed to the back panel by attaching an optional USB port expansion cable. There are three ways to use this additional USB port:

JP5	USB2	JP6
11	1 2	12
13	3 4	14
15	5 6	16
17	7 8	18
19	9 10	20

1. For using both two USB ports: Attach the optional USB port expansion cable to connect Pin 1~10 on USB2 slot.

JP5	USB2	JP6
11	1 2	12
13	3 4	14
15	5 6	16
17	7	8 18
19	9 10	20

2. For using one USB port on CNR card: Attach a jumper to short Pin 5 and 15, Pin 7 and 17. The additional USB ports plug can be attached via JP6 (Pin 2, 4, 6, 8, 10, and Pin 12, 14, 16, 18, 20), but there will be only one USB-port function available from this header.

JP5	USB2	JP6
11	1 2	12
13	3 4	14
15	5 6	16
17	7	8 18
19	9 10	20

3. For using one USB port on AGP card: Attach a jumper to short Pin 6 and 16, Pin 8 and Pin 11, 13, 15, 17, 19), but there will be only one USB-port function available from this header.

(9). CD1: Internal CD-ROM Drive Audio Cable Header

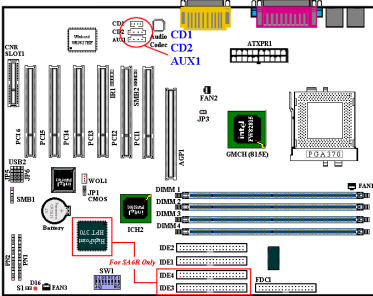

This header is for the internal CD-ROM drive audio cable connection. Please check your audio cable attached with the CD-ROM drive to see which type of connector you have and then plug it into this header.

(10). SW1: Front Side Bus Speed Setting DIP Switch

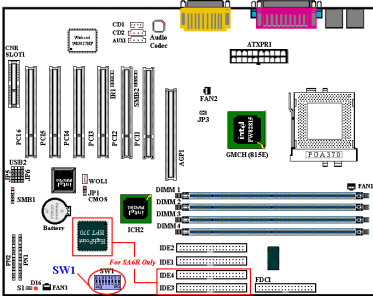

This switch allows you to manually setting the front side bus speed. See Table 2-2 for detailed settings.

The default settings:
 DIPSW 1, 2, 5: "ON"
 DIPSW 3, 4, 6, 7, 8: "OFF"

DIPSW	1	2	3	4	5	6	7	8
ON								
OFF								

DIPSW Default Settings

Table 2-2. SW1 Configurations

1-2	All ON	Use CPU Default Frequency Setting	
	All Off	Use SW1: 3-4 Frequency Setting	
3-4	3: ON 4: ON	66MHz	If you want to use "SW1: 3-4" to set CPU frequency, the "SW1: 1-2" must be set "OFF".
	3: OFF 4: ON	100MHz	
	3: OFF 4: OFF	133MHz	
	3: ON 4: OFF	No Define	
5	ON	Use CPU Freq Strap in ICH Register	Must set ON
	OFF	Force CPU Freq Strap to Safe Mode (1111)	
6	ON	No Reboot on 2 nd Watchdog Timeout	Must set OFF
	OFF	Reboot on 2 nd Watchdog Timeout	
7	OFF	Use Primary Codec	
8	ON	SoftMenu Disable	

(11). JP1 (CMOS): CMOS Discharge Jumper

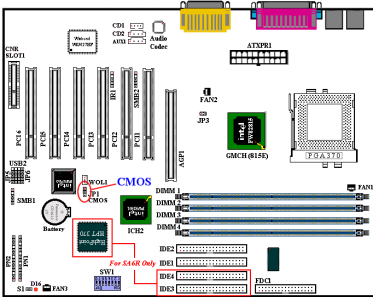

This jumper discharges the CMOS memory. When you install the motherboard, make sure this jumper is set for normal operation (pin 1 and 2 shorted). See figure 2-8.

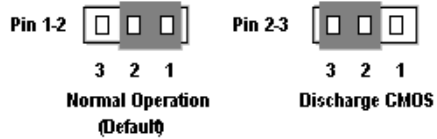
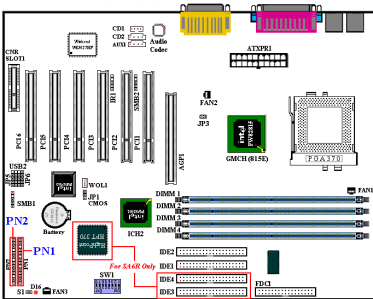

Figure 2-8. JP1 (CMOS) jumper setting

Note

Before you clear the CMOS, you have to first turn the power off (including the +5V standby power). Otherwise, your system may work abnormally or malfunction.

(12). PN1 and PN2 Headers



PN1 and PN2 are for switches and indicators of the chassis' front panel. There are several functions that come from these two headers. You have to watch the pin position and the orientation, or you may cause system malfunctions. Figure 2-9 shows you the functions of PN1 and PN2.

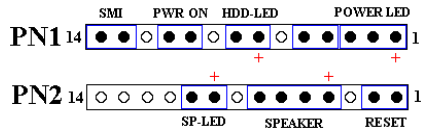

Figure 2-9. The definition of PN1 and PN2 pins

PN1 (Pin 1-2-3-4-5): Power LED Headers

There is a specific orientation for pins 1 through 3. Insert the three-threaded power LED cable to pins 1~3. Check to make sure the correct pins go to the correct connectors on the motherboard. If you install them in the wrong direction, the power LED light will not illuminate correctly.

Note: Watch the power LED pin position and orientation.

PN1 (Pin 7 - 8): HDD LED Header

Attach the cable from the case's front panel HDD LED to this header. If you install it in the wrong direction, the LED light will not illuminate correctly.

Note: Watch the HDD LED pin position and the orientation.

PN1 (Pin 10 - 11): Power on Switch Header

Attach the cable from the case's front panel power switch to this header.

PN1 (Pin 13-14): Hardware Suspend Switch (SMI Switch) Header

Attach the cable from the case's front panel suspend switch (if there is one) to this header. Use this switch to enable/disable the power management function through hardware.

PN2 (Pin 1-2): Hardware Reset Switch Header

Attach the cable from the case's front panel reset switch to this header. Press and hold the reset button for at least one second to reset the system.

PN2 (Pin 4-5-6-7): Speaker Header

Attach the cable from the system speaker to this header.

PN2 (Pin 9-10): Suspend LED Header

Insert the two-threaded suspend LED cable into pin 9 and pin 10. If you install it in the wrong direction, the LED light will not illuminate correctly.

Note: Watch the Suspend LED pin position and the orientation.

Table 2-3. PN1 and PN2 pin count name list

PIN Name		Significance of signal	PIN Name		Significance of signal
PN1	PIN 1	VCC (+5VDC)	PN2	PIN 1	Ground
	PIN 2	No connection		PIN 2	Reset input
	PIN 3	Power LED (-)		PIN 3	No connection
	PIN 4	Keyboard inhibit Signal		PIN 4	VCC (+5VDC)
	PIN 5	Ground		PIN 5	Ground
	PIN 6	No connection		PIN 6	Ground
	PIN 7	VCC (+5VDC)		PIN 7	Speaker Signal
	PIN 8	HDD LED (-)		PIN 8	No connection
	PIN 9	No connection		PIN 9	VCC (+5VDC)
	PIN 10	5VSB		PIN 10	Suspend LED (-)
	PIN 11	Power On/Off		PIN 11	No connection
	PIN 12	No connection		PIN 12	No connection
	PIN 13	Ground		PIN 13	No connection
	PIN 14	Suspend signal		PIN 14	No connection

Now let's see the I/O connectors that the SA6/SA6R uses, and what their functions are.

(13). S1: Chassis Intrusion Header

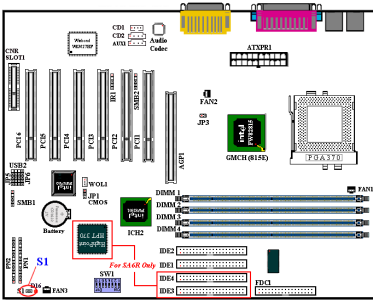

This header is for the connection of chassis intrusion detection.

(14). FDC1 Connector

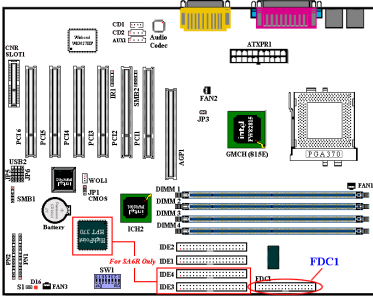

This 34-pin connector is called the “floppy disk drive connector”. You can connect a 360K, 5.25”, 1.2M, 5.25”, 720K, 3.5”, 1.44M, 3.5” or 2.88M, 3.5” floppy disk drive. You can even connect a 3 Mode floppy disk drive (a 3 1/2” drive used in Japanese computer systems).

A floppy disk drive ribbon cable has 34 wires and two connectors to provide the connection of two floppy disk drives. After connecting the single end to the FDC1, connect the two connectors on the other end to the floppy disk drives. In general, people only install one floppy disk drive on their computer system. The connector attached to the longer length of ribbon should be attached to the

motherboard connector.

Note

A red mark on a wire typically designates the location of pin 1. You need to align pin 1 of the wire to pin 1 of the FDC1 connector and then insert.

(15). IDE1/IDE2 and IDE3/IDE4 Connectors

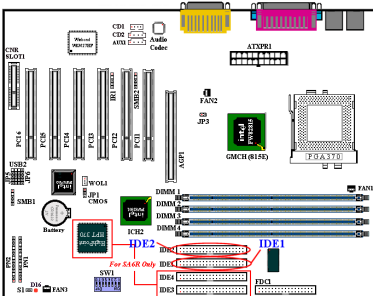

An IDE hard disk drive ribbon cable has 40 wires and two connectors to provide a connection for two IDE hard disk drives. After connecting the single end to the IDE1 (or IDE2), connect the two connectors on the other end to the IDE hard disk drives (or CD-ROM drive, LS-120, etc.). Again the connector attached to the longer ribbon length should be attached to the motherboard.

For SA6R: This motherboard’s built-in HighPoint HPT370 chipset can provide you the capability to support two more IDE channels, IDE3 and IDE4 (also support ATA-100 specifications). This bonus features allows you to have eight IDE devices in total for your computer system.

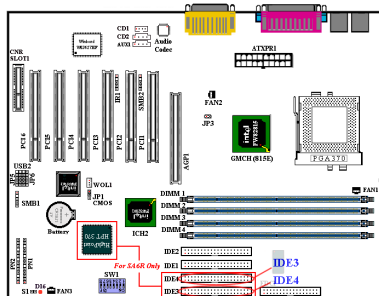

Before you install a hard disk, there are some things you need to be aware of:

- ◆ The “Primary” refers to the first connector on the motherboard; that is, the IDE1 connector on the motherboard.
- ◆ The “Secondary” refers to the second connector on the motherboard; that is, the IDE2 connector on the motherboard.
- ◆ Two hard disks can be connected to each connector: The first HDD is referred to as the “Master” and the second HDD is referred to as the “Slave”.
- ◆ For performance issues, we strongly suggest not to install

CD-ROM drive on the same IDE channel with a hard disk, or the system performance on this channel may drop (for how much is depending on the performance of your CD-ROM drive).

Note

- The Master or Slave status of the hard disk drive is set on the hard disk itself. Please refer to the hard disk drive user’s manual.
- A red mark on a wire typically designates the location of pin 1. You need to align the wire pin 1 to the IDE connector pin 1, and then insert the wire connector into the IDE connector.

How to install the Ultra ATA/66 Cable Assembly:

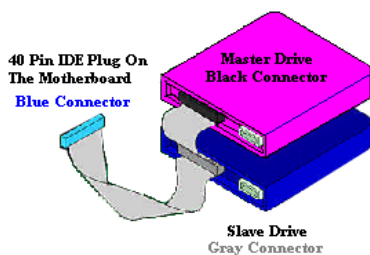

Figure 2-10. How to connect an ATA/66 Cable to the Motherboard

- The **BLUE** connector **MUST** be plugged into the motherboard or your system will not work.
- Each connector on the Ultra ATA/66 cable assembly has a small polarization tab centrally located on the body of the plastic. This fits into the matching slot on the mating plugs on the motherboard and the drives, thus assuring positive mating (pin #1 to pin #1)
- The red line on the cable should be aligned with pin #1. On the drives this will result in the red line facing the power connector. Attach the **BLUE** connector to the appropriate 40-pin IDE plug on the motherboard.
- Attach the **BLACK** connector to the mating plug on the master hard drive. Attach the **GREY** connector to the mating plug on the slave drive (secondary hard drive, CD-ROM, or tape drive). Please refer figure 2-10.

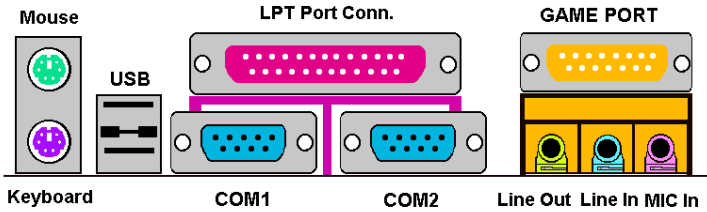

Figure 2-11. SA6/SA6R back panel connectors

Figure 2-11 shows the SA6/SA6R back panel connectors. These connectors are for connection to outside devices to the motherboard. We will describe which devices will attach to these connectors below.

(16). Keyboard: PS/2 Keyboard Connector

Attach a PS/2 keyboard connector to this 6-pin Din-connector. If you use an AT keyboard, you can go to a computer store to purchase an AT to ATX converter adapter. You can then connect your AT keyboard to this connector. We suggest you use a PS/2 keyboard for best compatibility.

(17). Mouse: PS/2 Mouse Connector

Attach a PS/2 mouse to this 6-pin Din-connector.

(18). USB Port Connectors

This motherboard provides two USB ports. Attach the USB connector from the individual device to these connectors.

You can attach USB devices such as a scanner, digital speakers, monitor, mouse, keyboard, hub, digital camera, joystick etc. to one of each of the USB connectors. You must make sure your operating system supports this feature and you may need to install an additional driver for individual devices. Please refer to your device user's manual for detailed information.

(19). Serial Port COM1 & COM 2 Connector

This motherboard provides two COM ports. You can connect an external modem, mouse or other devices that support this communication protocol to this connector. You can decide which external device you want to connect to COM1 and COM2. The COM port can only have one device connected at a time.

(20). Parallel Port Connector

This parallel port is also called an "LPT" port because it usually connects to the printer. You can connect other devices that support this communication protocol, like an EPP/ECP scanner, etc.

(21). Line Out, Line In and Mic In Connector

Line Out connector: You can connect an external stereo speaker signal input plug to this connector, or you can connect the plug from here to the stereo audio equipment AUX signal input socket. Remember, the motherboard does not have a built in amplifier to drive the speaker, so you must use a speaker that has a built in amplifier, or you may not hear any sound or only a small volume of sound from the speaker.

Line In Connector: You can connect the TV adapter audio output signal, or external audio sources, like a CD walkman, video camcorder, VHS recorder audio output signal plug to this connector. Your audio

software can control the input level for the line-in signal.

Mic In Connector: You can connect the plug from the microphone to this connector. Do not connect other audio (or signal) sources to this connector.

(22). MIDI/GAME Port Connector

You can connect your joystick, game pad, or other simulation hardware device DIN 15-pin plugs to this connector. Please refer to the further connection notes of the device's user's manual for further detailed information.



Chapter 3. Introducing the BIOS

The BIOS is a program located on a Flash Memory chip on the motherboard. This program will not be lost when you turn the computer off. This program is also referred to as the boot program. It is the only channel the hardware circuit has to communicate with the operating system. Its main function is to manage the setup of the motherboard and interface card parameters, including simple parameters such as time, date, hard disk drive, as well as more complex parameters such as hardware synchronization, device operating mode, **CPU SOFT MENU™ III** features and setup of CPU speed. The computer will operate normally, or will operate at its best, only if all of these parameters are correctly configured through the BIOS.



Don't change the parameters inside the BIOS unless you fully understand their meanings and consequences

The parameters inside the BIOS are used to setup the hardware synchronization or the device-operating mode. If the parameters are not correct, they will produce errors, the computer will crash, and sometimes you will not even be able to boot the computer after it has crashed. We recommend that you do not change the parameters inside the BIOS unless you are very familiar with them. If you are not able to boot your computer anymore, please refer to the section “**Erase CMOS data**” in Chapter 2.

When you start the computer, the BIOS program controls it. The BIOS first operates an auto-diagnostic test called POST (Power On Self Test) for all of the necessary hardware. It then configures the parameters of the hardware synchronization, and detects all of the hardware. Only when these tasks are completed does it give up control of the computer to the next level, which is the operating system (OS). Since the BIOS is the only channel for hardware and software to communicate, it is the key factor for system stability, and in ensuring that your system performs at its best. After the BIOS has achieved the auto-diagnostic and auto-detection operations, it will display the following message:

PRESS DEL TO ENTER SETUP

The message will be displayed for three to five seconds, if you press the key, you will access the BIOS Setup menu. At that moment, the BIOS will display the following screen:

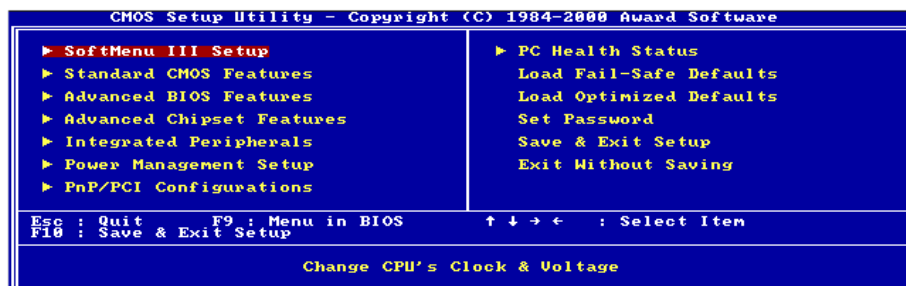

Figure 3-1. CMOS Setup Utility

In the BIOS Setup main menu of Figure 3-1, you can see several options. We will explain these options step by step in the following pages of this chapter, but let us first see a short description of the function keys you may use here:

- Press **Esc** to quit the BIOS Setup.
- Press **↑ ↓ ←→** (up, down, left, right) to choose, in the main menu, the option you want to confirm or to modify.
- Press **F10** when you have completed the setup of BIOS parameters to save these parameters and to exit the BIOS Setup menu.
- Press **Page Up/Page Down** or **+/-** keys when you want to modify the BIOS parameters for the active option.

Computer Knowledge: CMOS Data

Maybe you have heard somebody saying that his or her CMOS DATA was lost. What is the CMOS? Is it important? The CMOS is the memory used to store the BIOS parameters that you have configured. This memory is passive. You can read its data, and you can also store data in it. But this memory has to be powered by a battery in order to avoid any loss of its data when the computer is turned off. Since you may have to change the CMOS battery when it is out of power, and if doing so you will lose all CMOS data, we recommend that you write down all the parameters of your hardware, or to put a label with these parameters on your hard disk.

3-1. CPU Setup [SOFT MENU™ III]

The CPU can be setup through a programmable switch (**CPU SOFT MENU™ III**) that replaces the traditional manual hardware configuration. This feature allows the user to more easily complete the installation procedures. You can install the CPU without configuring any jumpers or switches. The CPU must be setup according to its specifications.

In the first option, you can press <F1> at any time to display all the items that can be chosen for that option.

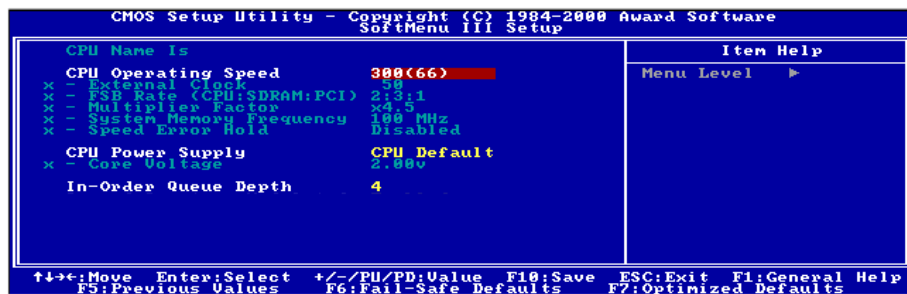

Figure 3-2. CPU SOFT MENU™ III

CPU Name Is:

Celeron MMX, Pentium III MMX.

CPU Operating Speed:

This option sets the CPU speed. In this field, the CPU speed is indicated like this: CPU Speed = External Clock x Multiplier Factor, select the CPU speed according the type and the speed of your CPU. For Intel Pentium® III and Celeron™ MMX processors, you can choose the following settings:

- 300 (66) ➤333 (66) ➤366 (66) ➤400 (66) ➤433 (66) ➤466(66)
- 500 (66) ➤500 (100) ➤533 (66) ➤533 (133) ➤550 (100) ➤566 (66)
- 600 (66) ➤600 (100) ➤600 (133) ➤633 (66) ➤650 (100) ➤667 (66)
- 667 (133) ➤700 (66) ➤700 (100) ➤733 (66) ➤733 (133) ➤750 (100)
- 766 (66) ➤800 (100) ➤800 (133) ➤850 (100) ➤866 (133) ➤933 (133)
- 1G ➤User Define

User Define:



The wrong settings of the multiplier and external clock in certain circumstances may cause CPU damage. Setting the working frequency higher than the PCI chipset or processor specs, may cause abnormal memory module functioning, system hangs, hard disk drive data lose, abnormal functioning of the VGA card, or abnormal functioning with other add-on cards. Using non-specification settings for your CPU is not the intention of this explanation. These should be used for engineering testing, not for normal applications.

If you use non-specification settings for normal operation, your system may not be stable, and may affect system reliability. Also, we do not guarantee the stability and compatibility for settings that are not within specification, and any damage of any elements on the motherboard or peripherals, is not our responsibility.

✱ **External Clock:**

After choosing the “**CPU Operating Speed**” option as “**Use Define**”, you can choose the figure of external clock from 50~250MHz.

Note

The CPU bus speed above 66MHz/100MHz/133MHz is supported but not guaranteed due to the PCI and chipset limitation.

✱ **FSB Rate (CPU:SDRAM:PCI):**

You can choose the ratio among $2:3:1 \rightarrow 3:3:1 \rightarrow 4:3:1 \rightarrow 4:4:1$ (within the range of external clock from **50~96MHz**), or $3:3:1 \rightarrow 4:3:1 \rightarrow 4:4:1$ (within the range of external clock from **97~140MHz**), or $4:3:1 \rightarrow 4:4:1$ (within the range of external clock from **140~250MHz**).

Take the external clock of **66MHz** for example:

If you choose the FSB ratio of **2:3:1**, the figure of CPU:SDRAM:PCI will be all divided by **2**, that is: **CPU** = $66 \times \frac{2}{2} = 66\text{MHz}$, **SDRAM** = $66 \times \frac{3}{2} = 100\text{MHz}$, **PCI** = $66 \times \frac{1}{2} = 33\text{MHz}$.

And if you choose the FSB ratio of **4:3:1**, the figure of CPU:SDRAM:PCI will be all divided by **4**, that is: **CPU** = $66 \times \frac{4}{4} = 66\text{MHz}$, **SDRAM** = $66 \times \frac{3}{4} = 50\text{MHz}$, **PCI** = $66 \times \frac{1}{4} = 17\text{MHz}$.

Note

An improper setting might cause the system unstable or even fail, please proceed with care.

✱ **Multiplier Factor:**

You can choose from the following multiplier factors: $2.0 \rightarrow 2.5 \rightarrow 3.0 \rightarrow 3.5 \rightarrow 4.0 \rightarrow 4.5 \rightarrow 5.0 \rightarrow 5.5 \rightarrow 6.0 \rightarrow 6.5 \rightarrow 7.0 \rightarrow 7.5 \rightarrow 8.0 \dots\dots$ (These factors might vary according to the different type and specification of the CPU you had installed).

Note

According to Celeron™ PPGA MMX processor types, some Celeron™ PPGA MMX processors will have the multiplier factor locked and the signal disabled. In this situation, there is no way to choose a higher multiplier factor.

✱ **System Memory Frequency:**

You can select the operating frequency for the main system memory. There are three options available: 100MHz, 133MHz, and Auto. The default setting is 100MHz.

✱ **Speed Error Hold:**

The default setting is *Disabled*. If you change the setting to “Enabled” when the CPU speed setting is wrong, the system will hold.

Normally, we do not recommend that you use the “User Define” option to setup CPU speed and multiplier factors. This option is for setup of future CPUs whose specifications are still unknown. The specifications of all present CPUs are included in the default settings. Unless you are very familiar with all CPU parameters, it is very easy to make mistakes when you define the external clock and the multiplier factor by

yourself.

Solution in case of booting problem due to invalid clock setup:

Normally, if the CPU clock setup is wrong, you will not be able to boot. In this case, turn the system off then on again. The CPU will automatically use its standard parameters to boot. You can then enter the BIOS Setup again and set up the CPU clock. If you can't enter the BIOS setup, you must try turning the system on a few times (3~4 times) or press <INSERT> when turning on, and the system will automatically use its standard parameters to boot. You can then enter BIOS SETUP again and set up the new parameters.

When you change your CPU:

This motherboard has been designed in such a way that you can turn the system on after having inserted a CPU in the socket without having to configure any jumpers or DIP switches. If you change your CPU, normally you just have to turn off the power supply, change the CPU and then set up the CPU parameters through **SOFT MENU™ III**. However, if the new CPU is slower than the old one (and is the same brand and type), we offer you two methods to successfully complete the CPU change operation.

Method 1: Setup up the CPU for the lowest speed for its brand. Turn the power supply off and change the CPU. Then turn the system on again, and set up the CPU parameters through **SOFT MENU™ III**.

Method 2: Since you have to open the computer case when you change the CPU, it could be a good idea to use the JP1 (CMOS) jumper to erase the parameters of the original CPU and to enter BIOS Setup to set up CPU parameters again.

Attention

After setting up the parameters and leaving the BIOS SETUP, and having verified that the system can be booted, do not press the Reset button or turn off the power supply. Otherwise the BIOS will not read correctly, the parameters will fail and you must enter **SOFT MENU™ III** again to set up the parameters all over again.

CPU Power Supply:

This option allows you to switch between CPU default and user-defined voltages.

CPU Default: The system will detect the CPU type and select the proper voltage automatically. When it is enabled, the option “**Core Voltage**” will show the current voltage setting that is defined by the CPU and this will not be changeable. We recommend using this CPU default setting and not changing it unless the current CPU type and voltage setting can not be detected or is not correct.

User Define: This option lets the user select the voltage manually. You can change values of the “**Core Voltage**” option lists by using the Page Up and Page Down keys.

In-Order Queue Depth

Two options are available: 1 and 4. This item lets you set cache buffer for CPU data processing. If you are not well acquainted with this item setting, please leave it on the default setting (4).

3-2. Standard CMOS Features Setup Menu

This section contains the basic configuration parameters of the BIOS. These parameters include date, hour, VGA card, FDD and HDD settings.



Figure 3-3. Standard CMOS Setup Screen Shot

Date (mm:dd:yy):

You can set the date in this item: month (mm), date (dd) and year (yy).

Time (hh:mm:ss):

You can set the time in this item: hour (hh), minute (mm) and second (ss).

IDE Primary Master / Slave and IDE Secondary Master / Slave:

These items have a sub-menu to let you choose further options. You can refer to figure 3-4 to check what options are available.



Figure 3-4. IDE Primary Master Setup Screen Shot

IDE HDD Auto-Detection:

Press the <Enter> key for the BIOS to auto detect all detailed parameters of the hard disk drives (HDD). If auto detection is successful, the correct values will be shown in the remaining items of this menu.

Note

- ❶ A new IDE HDD must be first formatted, otherwise it can not read/write. The basic step in using a HDD is to make a **HDD low-level format**, then run FDISK, and then FORMAT the drive. Most current HDDs have already been subjected to low-level format at the factory, so you can probably skip this operation. Remember though, the primary IDE HDD must have its partition set to active within the FDISK procedure.
- ❷ If you are using an old HDD that is already formatted, auto detection can not detect the correct parameters. You may need to do a low-level format or set the parameters manually, and then check if the HDD is working.

IDE Primary Master:

Three settings are available: *Auto*, *Manual* and *None*. If you choose Auto, the BIOS will automatically check what kind of hard disk you are using. If you want to set the HDD parameters yourself, make sure you fully understand the meaning of the parameters, and be sure to refer to the manual provided by the HDD manufacturer to get the settings right.

Access Mode:

Since old operating systems were only able to support HDDs with capacities no bigger than 528MB, any hard disk with more than 528MB was unusable. AWARD BIOS features a solution to this problem: you can, according to your operating system, choose four operating modes: NORMAL → LBA → LARGE → Auto.

The HDD auto detection option in the sub-menu will automatically detect the parameters of your hard disk and the mode supported.

Auto: Lets the BIOS detect your HDD access mode and make the decisions.

Normal mode: Standard normal mode supports hard disks of up to 528MB or less. This mode directly uses positions indicated by Cylinders (CYLS), Heads, and Sectors to access data.

LBA (Logical Block Addressing) mode: The earlier LBA mode can support HDD capacities of up to 8.4GB, and this mode uses a different method to calculate the position of disk data to be accessed. It translates Cylinders (CYLS), Heads and Sectors into a logical address where data is located. The Cylinders, Heads, and Sectors displayed in this menu do not reflect the actual structure of the hard disk. They are just reference values used to calculate actual positions. Currently, all high capacity hard disks support this mode and that is why **we recommend you use this mode**. Currently, the BIOS can support the INT 13h extension function, enabling the LBA mode to support hard disk drive capacities exceeding 8.4GB.

Large Mode: When the number of cylinders (CYLS) of the hard disk exceeds 1024 and DOS is not able to support it, or if your operating system does not support LBA mode, you should select this mode.

Capacity:

This item auto displays your HDD size. Note that this size is usually slightly greater than the size given by a disk checking program of a formatted disk.

Note

All the items below are available when you set the item "Primary IDE Master" to "Manual".

Cylinder:

When disks are placed directly above one another along the shaft, the circular vertical "slice" consisting of

all the tracks located in a particular position is called a cylinder. You can set the number of cylinders for a HDD. The minimum number you can enter is 0, the maximum number you can enter is 65536.

Head:

This is the tiny electromagnetic coil and metal pole used to create and read back the magnetic patterns on the disk (also called the read/write head). You can configure the number of read/write heads. The minimum number you can enter is 0, the maximum number you can enter is 255.

Precomp:

The minimum number you can enter is 0, the maximum number you can enter is 65536.

Warning

Setting a value of 65536 means no hard disk exists.

Landing Zone:

This is a non-data area on the disk's inner cylinder where the heads can rest when the power is turned off. The minimum number you can enter is 0, the maximum number you can enter is 65536.

Sector:

The minimum segment of track length that can be assigned to stored data. Sectors usually are grouped into blocks or logical blocks that function as the smallest units of data permit. You can configure this item to sectors per track. The minimum number you can enter is 0, the maximum number you can enter is 255.

Drive A & Drive B:

If you have installed the floppy disk drive here, then you can select the type of floppy drive it can support. Six options are available: None → 360K, 5.25 in. → 1.2M, 5.25in. → 720K, 3.5 in. → 1.44M, 3.5 in. → 2.88M, 3.5 in.

Floppy 3 Mode Support:

Four options are available: Disabled → Driver A → Driver B → Both. The default setting is *Disabled*. 3 Mode floppy disk drives (FDD) are 3 1/2" drives used in Japanese computer systems. If you need to access data stored in this kind of floppy, you must select this mode, and of course you must have a 3 Mode floppy drive.

Video:

You can select the VGA modes for your video adapter, four options are available: EGA/VGA → CGA 40 → CGA 80 → MONO. The default setting is EGA/VGA.

Halt On:

You can select which type of error will cause the system to halt. Five options are available: All Errors → No Errors → All, But Keyboard → All, But Diskette → All, But Disk/Key.

You can see your system memory list in the lower left box, it shows the *Base Memory*, *Extended Memory* and *total Memory size* configurations in your system. It is detected by the system during boot-up procedure.

3-3. Advanced BIOS Features Setup Menu

With each item, you can press <Enter> at any time to display all the options for that item.

Attention

Advanced BIOS Features Setup Menu has already been set for maximum operation. If you do not really understand each of the options in this menu, we recommend you use the default values.



Figure 3-5. Advanced BIOS Features Setup Screen

Virus Warning:

This item can be set to Enabled or Disabled, the default setting being *Disabled*.

When this feature is enabled, if there is any attempt from a software or an application to access the boot sector or the partition table, the BIOS will warn you that a boot virus is attempting to access the hard disk.

CPU Level 1 Cache:

This item is used to enable or to disable the CPU level 1 cache. When the cache is set to *Disabled* it is much slower, so the default setting for this item is *Enabled* since it will speed up memory access. Some old and very poorly written programs will make the computer malfunction or crash if the system speed is too high. In this case, you should disable this feature. The default setting is *Enabled*.

CPU Level 2 Cache:

This item is used to enable or to disable the CPU level 2 cache. When the external cache is *enabled*, it will speed up memory access, and the system will work faster. The default setting is *Enabled*.

CPU L2 Cache ECC Checking:

This item is used to enable or to disable the CPU level 2 cache ECC checking function. The default setting is *Enabled*.

Processor Number Feature:

This feature can let the program read the serial number inside your processor. This feature only works with Intel® Pentium® III processors. When you install a Pentium® III processor into your motherboard, and when your system boots-up then this item will show up in BIOS.

Two items will be available: Enabled and Disabled. When you choose Enabled, the specific program can read your processor's serial number. When you choose Disabled it will not allow the program to read your processor's serial number. The default setting is Disabled.

Quick Power On Self Test:

After the computer has been powered on, the BIOS of the motherboard will run a series of tests in order to check the system and its peripherals. If the Quick Power on Self-Test feature is enabled, the BIOS will simplify the test procedures in order to speed up the boot process. The default setting is *Enabled*.

First Boot Device:

When the computer boots up, the BIOS attempts to load the operating system from the devices in the sequence selected in these items: floppy disk drive A, LS/ZIP devices, hard drive C, SCSI hard disk drive or CD-ROM. There are eleven options for the boot sequence that you can choose (The default setting is *Floppy*):

Floppy → LS120 → HDD-0 → SCSI → CDROM → HDD-1 → HDD-2 → HDD-3 → ZIP100 → LAN
→ Disabled.

Second Boot Device:

Description is the same as the *First Boot Device*, the default setting is *HDD-0*.

Third Boot Device:

Description is same as the *First Boot Device*, the default setting is *LS/ZIP*

Boot Other Device:

Two options are available: Enabled or Disabled. The default setting is *Enabled*. This setting allows the BIOS to try three kinds of boot devices that are set from the above three items.

Swap Floppy Drive:

This item can be set as Enabled or Disabled. The default setting is *Disabled*. When this feature is enabled, you don't need to open the computer case to swap the position of floppy disk drive connectors. Drive A can be set as drive B and drive B can be set as drive A.

Boot Up Floppy Seek:

When the computer boots up, the BIOS detects if the system has an FDD or not. When this item is enabled, if the BIOS detects no floppy drive, it will display a floppy disk drive error message. If this item is disabled, the BIOS will skip this test. The default setting is *Disabled*.

Boot Up NumLock Status:

On: At boot up, the Numeric Keypad is in numeric mode. (Default Settings)

Off: At boot up, the Numeric Keypad is in cursor control mode.

Typematic Rate Setting:

This item allows you to adjust the keystroke repeat rate. When set to *Enabled*, you can set the two keyboard typematic controls that follow (*Typematic Rate* and *Typematic Rate Delay*). If this item is set to *Disabled*,

the BIOS will use the default setting. The default setting is *Enabled*.

Typematic Rate (Chars/Sec):

When you press a key continuously, the keyboard will repeat the keystroke according to the rate you have set (Unit: characters/second) . Eight options are available: 6 → 8 → 10 → 12 → 15 → 20 → 24 → 30 → Back to 6. The default setting is 30.

Typematic Delay (Msec):

When you press a key continuously, if you exceed the delay you have set here, the keyboard will automatically repeat the keystroke according to a certain rate (Unit: milliseconds). Four options are available: 250 → 500 → 750 → 1000 → Back to 250. The default setting is 250.

Security Option:

This option can be set to System or Setup. The default setting is *Setup*. After you have created a password through PASSWORD SETTING, this option will deny access to your system (System) or modification of computer setup (BIOS Setup) by unauthorized users.

SYSTEM: When you choose System, a password is required each time the computer boots up. If the correct password is not given, the system will not start.

SETUP: When you choose Setup, a password is required only when accessing the BIOS Setup. If you have not set a password in the PASSWORD SETTING option, this option is not available.

To disable security, select *Set Supervisor Password* at main menu and then you will be asked to enter the password. Do not type anything and just press the <Enter> key and it will disable security. Once security is disabled, the system will boot and you can enter the *BIOS setup menu* freely

Notice

Don't forget your password. If you forget the password, you will have to open the computer case and clear all information in the CMOS before you can start up the system. But by doing this, you will have to reset all previously set options.

OS Select For DRAM > 64MB:

When the system memory is bigger than 64MB, the communication method between the BIOS and the operating system will differ from one operating system to another. If you use OS/2, select *OS2*; if you are using another operating system, select *Non-OS2*. The default setting is *Non-OS2*.

Report No FDD For WIN 95:

When using Windows[®] 95 without a floppy drive, please set this item to *Yes*. Otherwise, set it to *No*. The default setting is *No*.

Delay IDE Initial (Secs):

This item is used to support some old models or special types of hard disks or CD-ROMs. They may need a longer amount of time to initialize and prepare for activation. Since the BIOS may not detect those kinds of devices during system booting. You can adjust the value to fit such devices. Larger values will give more delay time to the device. The minimum number you can enter is 0, the maximum number you can enter is 15. The default setting is 5. For best system performance, we strongly suggest you to set it to 0.

3-4. Advanced Chipset Features Setup Menu

The Chipset Features Setup Menu is used to modify the contents of the buffers in the chipset on the motherboard. Since the parameters of the buffers are closely related to hardware, if the setup is not correct or is false, the motherboard will become unstable or you will not be able to boot up. If you don't know the hardware very well, use default values (i.e. use the LOAD SETUP DEFAULTS option). The only time you might consider making any changes is if you discover that data is being lost while using your system.



Figure 3-6. Chipset Features Setup Screen

You can use the arrow keys to move between the items. Use **↑**, **↓** and **<Enter>** key to change the values. When you have finished setting up the chipset, press **<Esc>** to go back to the main menu.

Note

The parameters in this screen are for system designers, service personnel, and technically competent users only. Do not reset these values unless you understand the consequences of your changes.

The first chipset settings deal with CPU access to DRAM. The default timings have been carefully chosen and should only be altered if data is being lost. Such a scenario might well occur if your system has mixed speed DRAM chips installed. In such a case, greater delays may be required to preserve the integrity of the data held in the slower memory chips.

SDRAM CAS Latency Time:

Two options are available: 2 and 3. The default setting is 3. You can select SDRAM CAS (Column Address Strobe) latency time according your SDRAM specification.

SDRAM Cycle Time Tras/Trc:

Two options are available: 5/7 and 7/9. The default setting is 7/9. This item controls the number of SDRAM clocks (SCLKs) used per access cycle.

SDRAM RAS-to-CAS Delay

Two options are available: 2 and 3. The default setting is 3. This item lets you insert a timing delay between the CAS and RAS strobe signals, used when DRAM is written to, read from, or refreshed. *Fast (2)* gives faster performance; and *Slow(3)* gives more stable performance. This item applies only when synchronous DRAM is installed in the system.

SDRAM RAS Precharge Time:

Two options are available: 2 and 3. The default setting is 3. This option lets you insert a timing delay between the CAS and RAS strobe signals, used when DRAM is written to, read from, or refreshed. *Fast (2)* gives faster performance; and *Slow (3)* gives more stable performance. This item applies only when synchronous DRAM is installed in the system.

System BIOS Cacheable:

You can select Enabled or Disabled. The default setting is *Enabled*. When you select *Enabled* allows caching of the system BIOS ROM at F0000h-FFFFFh, resulting in better system performance. However, if any program writes to this memory area, a system error may result.

Video BIOS Cacheable:

You can select Enabled or Disabled. The default setting is *Enabled*. *Enabled* allows caching of the video BIOS, resulting in better system performance. However, if any program writes to this memory area, a system error may result.

Memory Hole At 15M-16M:

Two options are available: Enabled and Disabled. The default setting is *Disabled*. This option is used to reserve the memory block 15M-16M for ISA adapter ROM. Some special peripherals need to use a memory block located between 15M and 16M, and this memory block has a size of 1M. We recommend that you disable this option.

CPU Latency Timer:

Two options are available: Enabled and Disabled. The default setting is *Enabled*.

Delayed Transaction:

Two options are available: Enabled and Disabled. The default setting is *Disabled*. Set the option to enabled or disabled PCI 2.1 features including passive release and delayed transaction for the chipset. This function is used to meet the latency of PCI cycles to or from the ISA bus. This option must be enabled to provide PCI 2.1 compliance. If you have an ISA card compatibility problem, you can try to enable or disable this option for optimal results.

AGP Graphics Aperture Size:

Two options are available: 32M → 64M. The default setting is *64M*. This option specifies the amount of system memory that can be used by the AGP device. The aperture is a portion of the PCI memory address range dedicated for graphics memory address space. Host cycles that hit the aperture range are forwarded to the AGP without any translation. See www.agpforum.org for AGP information.

AGP Data Transfer Rate:

You can select the AGP device data transfer rate capability. Two options are available: 2X Mode and 4X Mode. The default setting is *4X Mode*.

3-5. Integrated Peripherals

In this menu, you can change the onboard I/O device, I/O port address and other hardware settings.

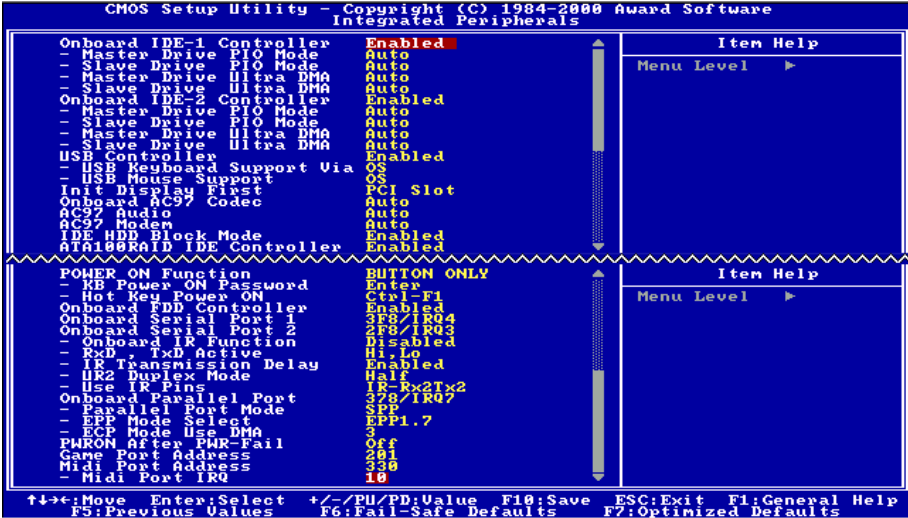

Figure 3-7. Integrated Peripherals Menu Screen

Onboard IDE-1 Controller:

The onboard IDE 1 controller can be set as Enabled or Disabled. The default setting is *Enabled*. The integrated peripheral controller contains an IDE interface with support for two IDE channels. If you choose *Disabled*, it will effect the settings of four items not available. For example, if you disabled the *Onboard IDE-1 Controller*, you will also disable the *Master/Slave Drive PIO Mode* and *Master/Slave Drive Ultra DMA*.

Master/Slave Drive PIO Mode

Six options are available: Auto → Mode 0 → Mode 1 → Mode 2 → Mode 3 → Mode 4. The five IDE PIO (Programmed Input/Output) items let you set a PIO mode (0-4) for each of the four IDE devices that the onboard IDE interface supports. Modes 0 through 4 provide successively increased performance. In Auto mode (default setting), the system automatically determines the best mode for each device.

Master/Slave Drive Ultra DMA

Two options are available: Auto and Disabled. The default setting is *Auto*. Ultra DMA is a DMA data transfer protocol that utilizes ATA commands and the ATA bus to allow DMA commands to transfer data at a maximum burst rate of 100 MB/sec.

Ultra DMA/33 or Ultra DMA/66/100 implementation is possible only if your IDE hard drive supports it and the operating environment includes a DMA driver (Windows® 95 OSR2 / 98 / NT / 2000 or a third-party IDE bus master driver).

Auto: If your hard drive and your system software both support Ultra DMA, select *Auto* to enable BIOS support.

Disabled: If you encounter a problem in using Ultra DMA devices, you can try to disable this item.

Onboard IDE-2 Controller:

Description is same as the *Onboard IDE-1 Controller*.

USB Controller:

Two options are available: Enabled and Disabled. The default setting is *Enabled*. This motherboard provides two Universal Serial Bus (USB) ports, thus supporting USB devices. If you don't want to use USB devices, set it to *Disabled*, then the item *USB Keyboard Support & USB Mouse Support* will also be disabled.

USB Keyboard Support Via: Two options are available: OS and BIOS. The default setting is *OS*. If you want to use USB keyboard in DOS environment, please set it to BIOS.

USB Mouse Support: Two options are available: OS and BIOS. The default setting is *OS*. If you want to use USB mouse in DOS environment, please set it to BIOS.

Init Display First:

Two options are available: PCI Slot and AGP. The default setting is *PCI Slot*. When you install an additional display card, you can choose either a PCI display card or an AGP display card to activate the display boot-up screen.

Onboard AC97 Codec:

Two options are available: Auto and Disabled. The default setting is *Auto*. Select "Disabled" if you want to use an optional add-on card, or both the functions of built-in and the add-on devices will be enabled.

AC97 Audio

Two options are available: Auto and Disabled. The default setting is *Auto*. If you set it to *Auto*, it will allow the BIOS to detect the audio device you use. If an audio device is detected, the onboard audio controller (815EP chipset family) will be able to support it. If you want to use another audio adapter card to connect the audio connectors, please set this item to *Disabled*.

AC97 Modem

Two options are available: Auto and Disabled. The default setting is *Auto*. If you set it to *Auto*, it will allow the BIOS to detect the modem device you use. If a modem device is detected, the onboard modem controller (815EP chipset family) will be able to support it. If you want to use another modem adapter card to connect the modem signal connectors, please set this item to *Disabled*.

IDE HDD Block Mode:

Block mode is also called block transfer, multiple commands, or multiple sector read/write. If your IDE hard drive supports block mode (most new drives do), select *Enabled* for automatic detection of the optimal number of block read/writes per sector the drive can support. The default setting is *Enabled*.

ATA100RAID IDE Controller: (For SA6R Only)

This motherboard's built-in HighPoint HPT370 chipset can provide you the capability to support two more

IDE channels, IDE3 and IDE4 (also support ATA-100 specifications). This bonus features allows you to have eight IDE devices in total for your computer system. Two options are available: Disabled and Enabled. The default setting is *Enabled*.

Power ON Function:

This item allows you to select which way you want your system to power on. Seven items are available: Button Only → Keyboard 98 → Password → Hot Key → Mouse Left → Mouse Right → Any Key. Default setting is *Button Only*.

Note

<p>The mouse wake up function can only be used with the PS/2 mouse, not with a mouse that uses the COM port and USB connection. <i>Mouse Left (Mouse Right)</i> means you need to double click the mouse <i>left (right)</i> button, for the computer to power on. You also need to note the compatibility issue with your PS/2 mouse. Some PS/2 mice cannot wake up the system because of compatibility problems. Also, if the specs of your keyboard are too old, it may fail to power on.</p>
--

KB Power ON Password: This option allows you to set a password required in order to Power ON your computer. You will be asked to enter your password and then to confirm it. Do not forget your password. Should you forget your password, you will have to open your computer case, clear the CMOS and reset all parameters again in order to be able to utilize this function.

Hot Key Power ON: There are twelve options are available, <Ctrl>-<F1> to <Ctrl>-<F12>. You can select this item and using the <Ctrl> plus the one of each function key (<F1> to <F12>) to power on the computer. The default setting is <Ctrl>-<F1>.

Onboard FDD Controller:

Two options are available: Enabled and Disabled. The default setting is *Enabled*. You can enable or disable the onboard FDD controller.

Onboard Serial Port 1:

This is used to specify the I/O address and IRQ of Serial Port 1. Six options are available: Disabled → 3F8/IRQ4 → 2F8/IRQ3 → 3E8/IRQ4 → 2E8/IRQ3 → AUTO. The default setting is *3F8/IRQ4*.

Onboard Serial Port 2:

This is used to specify the I/O address and IRQ of Serial Port 2. Six options are available: Disabled → 3F8/IRQ4 → 2F8/IRQ3 → 3E8/IRQ4 → 2E8/IRQ3 → AUTO. The default setting is *2F8/IRQ3*.

Onboard IR Function: Three options are available: IrDA (HPSIR) mode → ASK IR (Amplitude Shift Keyed IR) mode → Disabled. The default setting is *Disabled*.

RxD , TxD Active: Four options are available: Hi, Hi → Hi, Lo → Lo, Hi → Lo, Lo. The default setting is *Hi, Lo*. Set IR transmission/reception polarity as High or Low.

IR Transmission Delay: Two options are available: Enabled and Disabled. The default setting is *Enabled*. Set IR transmission delays 4 character-time (40 bit-time) when SIR is changed from RX mode to TX mode.

UR2 Duplex Mode: Two options are available: Full and Half. The default setting is *Half*. This item lets you choose the operation mode for your IR KIT. Some IR device only can work at half duplex mode. Refer to your IR KIT user's guide to find out which setting is correct.

Use IR Pins: Two options are available: Rx2D2, Tx2D2 and IR-Rx2Tx2. The default setting is *IR-Rx2Tx2*. If

you choose *RxD2*, *TxD2*, your motherboard must support a COM port IR KIT connection. Otherwise, you can only choose the *IR-Rx2Tx2* to use the IR header on your motherboard to connect your IR KIT. Please use the default setting.

Onboard Parallel Port:

Sets the I/O address and IRQ of the onboard parallel port. Four options are available: Disable → 378/IRQ7 → 278/IRQ5 → 3BC/IRQ7. Default setting is *378/IRQ7*.

Parallel Port Mode: Four options are available: SPP → EPP → ECP → ECP+EPP. The default setting is *SPP* mode.

EPP Mode Select: Two options are available: EPP1.7 → EPP1.9. The default setting is *EPP 1.7*. When the mode selected for the parallel port mode is EPP, the two EPP version options are available.

ECP Mode Use DMA: Two options are available: 1 → 3. The default setting is *3*. When the mode selected for the parallel port mode is ECP, the DMA channel selected can be Channel 1 or Channel 3.

PWRON After PWR-Fail:

This setting lets you set the system action after a power failure. Three options are available: On → Former-Sts → Off. The default setting is *Off*.

Game Port Address:

Three options are available: Disabled → 201 → 209. The default setting is *201*. This item sets the address of the onboard game port connector.

Midi Port Address:

Four options are available: Disabled → 330 → 300 → 290. The default setting is *330*. This item sets the address of the onboard midi port connector.

Midi Port IRQ: Two options are available: 5 → 10. The default setting is *10*. This item sets the IRQ of the onboard midi port connector. If you choose disable the *Midi Port Address*, then this field is not available.

Note

If you bought an audio adapter and wanted to replace the use of onboard audio solution, you have to disable three items in BIOS. Otherwise, your audio adapter may not work well. These three items are:

AC 97 Audio: set to *Disabled*

Game Port Address: set to *Disabled*

Midi Port Address: set to *Disabled*

3-6. Power Management Setup Menu

The difference between Green PCs and traditional computers is that Green PCs have a power management feature. With this feature, when the computer is powered on but inactive, the power consumption is reduced in order to save energy. When the computer operates normally, it is in Normal mode. In this mode, the Power Management Program will control the access to video, parallel ports, serial ports and drives, and the operating status of the keyboard, mouse and other device. These are referred to as Power Management Events. In cases where none of these events occur, the system enters the power saving mode. When one of the controlled events occurs, the system immediately returns to normal mode and operates at its maximum speed. Power saving modes can be divided into three modes according to their power consumption: Doze Mode, Standby Mode, and Suspend Mode. The four modes proceed in the following sequence:

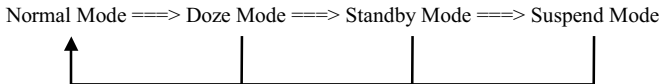

The system consumption is reduced according the following sequence:

Normal > Doze > Standby > Suspend

1. In the Main Menu, select “**Power Management Setup**” and press <Enter>. The following screen is displayed:



Figure 3-8. Power Management Setup Menu

2. Use the arrow keys to go to the item you want to configure. To change the settings, use \uparrow , \downarrow and <Enter> key.
3. After you have configured the power management feature, press <Esc> to go back to the Main Menu.

If you want ACPI functions to work normally, you should notice two things. One is your operating system must support ACPI. Now the Windows® 98, Windows® 2000, and Windows® Millennium all supports these functions. The second thing is that all devices and add-on cards in your system must fully support ACPI, both hardware and software (drivers). If you want to know if your devices or add-on cards support ACPI or not, please contact the device or add-on card manufacturer for more information. If you want to know more about ACPI specifications, please go to the address below for more detailed information:

<http://www.teleport.com/~acpi/acpihtml/home.htm>

ACPI requires an ACPI-aware operating system. ACPI features include:

- Plug and Play (including bus and device enumeration) and APM functionality normally contained in the BIOS.
- Power management control of individual devices, add-in cards (some add-in cards may require an ACPI-aware driver), video displays, and hard disk drives.
- A Soft-off feature that enables the operating system to power off the computer.
- Support for multiple wake-up events (see Table 3-1).
- Support for a front panel power and sleep mode switch. Table 3-2 describes the system states based on how long the power switch is pressed, depending on how ACPI is configured with an ACPI-aware operating system.

System States and Power States:

Under ACPI, the operating system directs all system and device power state transitions. The operating system puts devices in and out of low-power states based on user preferences and knowledge of how devices are being used by applications. Devices that are not being used can be turned off. The operating system uses information from applications and user settings to put the system as a whole into a low-power state.

Table 3-1: Wake Up Device and Events

The table below describes which devices or specific events can wake the computer from specific states.

These device/events can wake up the computer.....from this state
Power switch	Sleeping mode or power off mode
RTC alarm	Sleeping mode or power off mode
LAN	Sleeping mode or power off mode
Modem	Sleeping mode or power off mode
IR command	Sleeping mode
USB	Sleeping mode
PS/2 keyboard	Sleeping mode or power off mode
PS/2 mouse	Sleeping mode or power off mode

Table 3-2: Effect of Pressing the Power Switch

If the system is in this state.....and the power switch is pressed forthe system enters this state
Off	Less than four seconds	Power on
On	More than four seconds	Soft off/Suspend
On	Less than four seconds	Fail safe power off
Sleep	Less than four seconds	Wake up

ACPI Suspend Type:

Two options are available: S1(POS) and S3(STR). The default setting is *S1(POS)*. Generally, ACPI has six states: System S0 state, S1, S2, S3, S4, S5. S1 and S3 states are described below:

The S1 (POS) State (POS means Power On Suspend):

While the system is in the S1 sleeping state, its behavior is as described below:

- The processor is not executing instructions. The processor's complex context is maintained.
- Dynamic RAM context is maintained.
- Power Resources are in a state compatible with the system S1 state. All Power Resources that supply a System Level reference of S0 are in the OFF state.
- Devices states are compatible with the current Power Resource states. Only devices which solely reference Power Resources which are in the ON state for a given device state can be in that device state. In all other cases, the device is in the D3 (off) state.
- Devices that are enabled to wake the system and that can do so from their current device state can initiate a hardware event which transitions the system state to S0. This transition causes the processor to continue execution where it left off.

To transition into the S1 state, the operating software does not have to flush the processor's cache.

The S3 (STR) State (STR means Suspend to RAM):

The S3 state is logically lower than the S2 state and is assumed to conserve more power. The behavior of this state is defined as follows:

- Processor is not executing instructions. The processor complex context is not maintained.
- Dynamic RAM context is maintained.
- Power Resources are in a state compatible with the system S3 state. All Power Resources that supply a System Level reference of S0, S1, or S2 are in the OFF state.
- Devices states are compatible with the current Power Resource states. Only devices which solely reference Power Resources which are in the ON state for a given device state can be in that device state. In all other cases, the device is in the D3 (off) state.
- Devices that are enabled to wake the system and that can do so from their current device state can initiate a hardware event which transitions the system state to S0. This transition causes the processor to begin execution at its boot location. The BIOS performs initialization of core functions as required to exit an S3 state and passes control to the firmware resume vector. Please see the ACPI Specification Rev. 1.0 book section 9.3.2 for more details on BIOS initialization.

From the software point of view, this state is functionally the same as the S2 state. The operational difference can be that some Power Resources that could be left ON in the S2 state might not be available to the S3 state. As such, additional devices can be required to be in logically lower D0, D1, D2, or D3 state for S3 than S2. Similarly, some device wake events can function in S2 but not S3.

Because the processor context can be lost while in the S3 state, the transition to the S3 state requires that the operating software flush all dirty cache to DRAM.

*** The information above for system S0 & S3 were referring to ACPI Specification Rev. 1.0.**

USB KB Wake-Up From S3:

Two options are available: Enabled and Disabled. The default setting is *Disabled*.

Power Management:

This item allows you to select the type (or degree) of power saving and is directly related to the following modes: (1) Suspend Mode and (2) HDD Power Down.

There are three options for power management, two of which have fixed mode settings:

- **User Define:** “User Define” defines the delay for accessing the power modes.
Suspend Mode: Disabled → 1 Min → 2 Min → 4 Min → 8 Min → 12 Min → 20 Min → 30 Min → 40 Min → 1 Hour. The default setting is *Disabled*.
HDD Power Down: Disabled → 1 Min → 2 Min → 3 Min → 4 Min → 5 Min → 6 Min → 7 Min → 8 Min → 9 Hour → 10 Min → 11 Min → 12 Min → 13 Min → 14 Min → 15 Min. The default setting is *Disabled*.
- **Min Saving:** When these two saving modes are enabled, the system is set up for minimum power savings.
Suspend Mode = 1 Hour
HDD Power Down = 15 Min.
- **Max Saving:** When the two saving modes are enabled, the system is set up for maximum power savings.
Suspend Mode = 1 Min.
HDD Power Down = 1 Min.

Suspend Mode/HDD Power Down:

These two items will be enable to change setting when item *Power Management* is set to *User Define*, these two item will also changes as table 3-3 below.

Table 3-3: Power Management Settings

Items	Power Management Settings		
	User Define	Min Saving	Max Saving
Suspend Mode	Disabled → 1 Min → 2 Min → 4 Min → 8 Min → 12 Min → 20 Min → 30 Min → 40 Min → 1 Hour. The default setting is <i>Disabled</i> .	1 Hour	1 Min
HDD Power Down	Disabled → 1 Min → 2 Min → 3 Min → 4 Min → 5 Min → 6 Min → 7 Min → 8 Min → 9 Hour → 10 Min → 11 Min → 12 Min → 13 Min → 14 Min → 15 Min. The default setting is <i>Disabled</i> .	15 Min	1 Min

Video Off Method:

Three video off methods are available: “Blank Screen”, “V/H SYNC + Blank” and “DPMS”. The default is “V/H SYNC+Blank”.

If this setting does not shut off the screen, select “Blank Screen”. If your monitor and video card support DMPS standard, select “DPMS”.

- **Blank Screen:** This option only writes blanks to the video buffer.
- **V/H SYNC + Blank:** This selection will cause the system to turn off the vertical and horizontal synchronization ports and write blanks to the video buffer.
- **DPMS:** Initial display power management signaling.

Video Off In Suspend:

Two options are available: Yes or No. The default setting is *Yes*. This item determines the manner in which the monitor is blanked.

Suspend Type:

Two options are available: Stop Grant and PwrOn Suspend. The default setting is *Stop Grant*.

Modem Use IRQ:

You can specify the IRQ for modem use. Eight options are available: NA → 3 → 4 → 5 → 7 → 9 → 10 → 11. The default setting is *NA*.

Soft-off by PWR-BTTN:

Two options are available: Instant-off and Delay 4 Sec.. The default setting is *Instant-off*. Pressing the power button for more than four seconds forces the system to enter the Soft-Off state when the system has “hung”.

Wake-Up by PCI card/LAN:

Two options are available: Enabled and Disabled. Default setting is *Disabled*. This item can let you wake-up your computer by PCI devices. For instance, if you had installed a PCI LAN card with Wake-Up on LAN capability, then you could wake-up your computer from another computer via a network by sending a wake-up frame signal. This feature also allows the PCI card built-in hardware function to support the wake up function without special cables connected to the motherboard.

Note

This feature needs a specific network interface which is optional. Also your ATX power supply +5V standby power must be at least 720mA compatible.

Power On by Ring:

Two options are available: Enabled and Disabled. Default setting is *Disabled*. If you connect an external modem to the onboard serial port, the system will be turned on when a telephone ring-up occurs.

CPU Thermal-Throttling

This option is used during Suspend To RAM (STR) mode. It controls the CPU speed as a percentage of regular power. The options include 87.5%, 75.0%, 62.5%, 50.0%, 37.5%, 25.0%, 12.5%. The default setting is set at 62.5%.

Resume by Alarm:

Two options are available: Enabled and Disabled. Default setting is *Disabled*. The RTC alarm can turn on the system. You can set Date (of month) and Time (hour, minute, and second) when you set this item to *Enabled*.

Reload Global Timer Events

When one of the specified events occur, the count down made for entry in power saving mode goes back to zero. Since the computer will enter a power saving mode only after an inactivity delay specified (time specific for Doze, Standby and Suspend modes) and after it has no activity, during this time period, any event will cause the computer to re-count the time elapsed. Resume events are operations or signals that cause the computer to resume time counting.

Primary IDE 0 / Primary IDE 1: Two options are available: Enabled and Disabled. The default setting is *Disabled*. If any primary IDE master/slave I/O activity occurs, it will cause the computer to re-count the time elapsed.

Secondary IDE 0 / Secondary IDE 1: Two options are available: Enabled and Disabled. Default setting is *Disabled*. If any secondary IDE master/slave I/O activity occurs, it will cause the computer to re-count the time elapsed.

FDD, COM, LPT Port: Two options are available: Enabled and Disabled. Default setting is *Enabled*. If any floppy disk, COM ports and Parallel port I/O activity occurs, it will cause the computer to re-count the time elapsed.

PCI PIRQ[A-D]#: Two options are available: Enabled and Disabled. Default setting is *Disabled*. If any INTA~INTD signal activity occurs, it will cause the computer to re-count the time elapsed.

3-7. PnP/PCI Configurations

This section describes configuring the PCI bus system. PCI, or Personal Computer Interconnect, is a system which allows I/O devices to operate at speeds nearing the speed the CPU itself uses when communicating with its own special components. This section covers some very technical items and it is strongly recommended that only experienced users should make any changes to the default settings.



Figure 3-9. PnP/PCI Configurations Setup Screen Shot

PNP OS Installed:

Two options are available: No and Yes. Default setting is *No*. Device resource assigned by PnP OS or BIOS.

Force Update ESCD:

If you want to clear ESCD data next time you boot up, and ask the BIOS to reset the settings for the Plug & Play ISA Card and the PCI Card, select Enabled. But the next time you boot up, this option will automatically be set as Disabled.

Computer Knowledge: ESCD (Extended System Configuration Data)

The ESCD contains the IRQ, DMA, I/O port, memory information of the system. This is a specification and a feature specific to the Plug & Play BIOS.

Resources Controlled By:

Two options are available: Auto(ESCD) and Manual. Default setting is *Auto(ESCD)*. When the setting is Auto(ESCD), the *IRQ Resources* and *Memory Resources* can not be changed. When resources are controlled manually, the *IRQ Resources* and *Memory Resources* can then be changed.

Legacy ISA devices compliant with the original PC AT bus specification, requiring a specific interrupt (such as IRQ4 for serial port 1).

PCI/ISA PnP devices compliant with the Plug and Play standard, whether designed for the PCI or ISA bus architecture.

The Award Plug and Play BIOS has the capability to automatically configure all of the boot and Plug and Play compatible devices. If you select *Auto (ESCD)*, The IRQ Resources item will be disabled, as the BIOS automatically assigns them. But if you have trouble in assigning the interrupt resources automatically, you

can select *Manual* to set which IRQ and DMA are assigned to PCI/ISA PnP or legacy ISA cards.

Figure 3-10 shows you the screen of IRQ resources. Each item has two options: PCI Device and Reserved. The default setting is *PCI Device*.

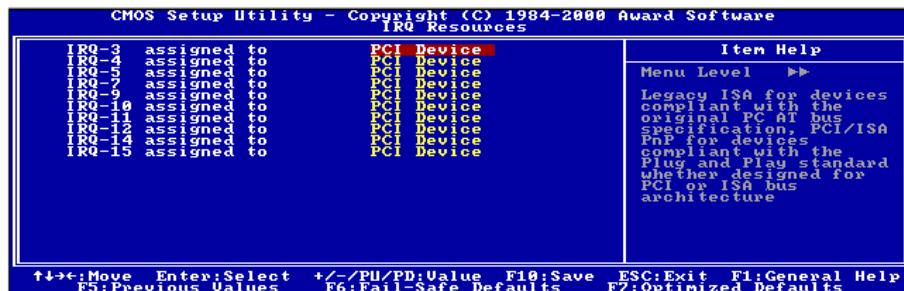

Figure 3-10. IRQ Resources Setup Screen Shot

PCI/VGA Palette Snoop:

This option allows the BIOS to preview VGA Status, and to modify the information delivered from the Feature Connector of the VGA card to the MPEG Card. This option can solve the display inversion to black after you have used the MPEG card.

Assign IRQ For VGA :

Two options are available: Disabled or Enabled. The default setting is *Enabled*. Name the interrupt request (IRQ) line assigned to the USB/VGA/ACPI (if any) on your system. Activity of the selected IRQ always awakens the system.

You can assign an IRQ for the PCI VGA or *Disabled*.

Assigned IRQ For USB:

Two options are available: Disabled or Enabled. The default setting is *Enabled*. If you need another IRQ to be freed up, you can choose to disable this item, and you can get an IRQ. But in some situations in Windows® 95 it may cause the USB port to malfunction or have other problems!

PIRQ 0~PIRQ 3:

Eleven options are available: Auto, 3, 4, 5, 7, 9, 10, 11, 12, 14, and 15. Default setting is *Auto*. This item allows the system to automatically specify the IRQ number for the device installed on PCI slots. Which means, the system can specify the fixed IRQ number for the device installed on the PCI slots (PCI slot 1 to PCI slot 6). This is a useful function when you want to fix the IRQ for a specific device.

For example, if you want to move your hard disk to another computer and don't want to re-install Windows® NT, then you can specify the IRQ for the device installed on the new computer to fit the original computer settings.

This feature is for the operating system that will record and fix the PCI configuration status, if you want to change it.

For the relations between the hardware layout of PIRQ (the signals from the ICH chipset), INT# (means PCI slot IRQ signals) and devices, please refer to the table below:

Signals	PCI slot 1	PCI slot 2	PCI slot 3	PCI slot 4	PCI slot 5	PCI slot 6
PIRQ_0 Assignment	INT A	INT B	INT B	INT D	INT C	INT D
PIRQ_1 Assignment	INT B	INT D	INT A	INT A	INT D	INT B
PIRQ_2 Assignment	INT C	INT C	INT D	INT B	INT A	INT C
PIRQ_3 Assignment	INT D	INT A	INT C	INT C	INT B	INT A

- Each PCI slot has four INT#s (INT A~INT D), and the AGP slot has two INT# (INTA and INT B).
- HPT370 used INT C.

3-8. PC Health Status

You can set the warning temperature for your computer system, and you can check the fan speeds and power supply voltages of your computer system. The features are useful for monitoring all the important parameters within your computer system. We call it the *PC Health Status*.

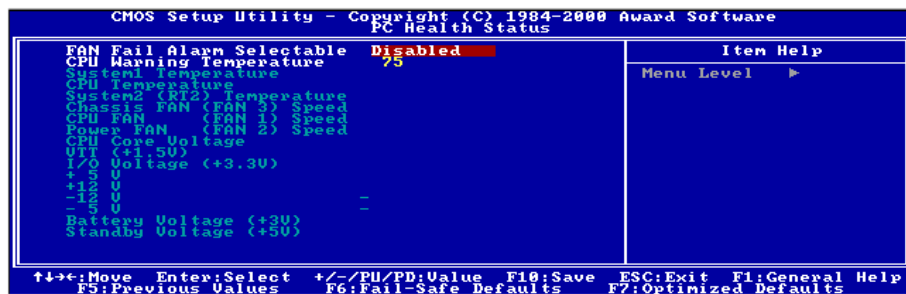

Figure 3-11. PC Health Status Screen Shot

FAN Fail Alarm Selectable:

This item lets you select which one of the fans will be monitored for malfunction. The options are: Disabled → Chassis Fan → CPU Fan → Power Fan → Auto. The default setting is *Disabled*.

CPU Warning Temperature:

This item lets you select the temperature at which you want the system to send out a warning message to the PC speakers or when the temperature goes beyond either limit. You can select the temperatures you want. The ranges are from 30°C/86°F to 120°C/248°F, default setting is 75°C/167°F.

All Voltages, Fans Speed and Thermal Monitoring:

These items list the current states of the CPU and environment (using RT1 and RT2 to detect them.) temperatures as well as fan speeds (CPU fan and chassis fan). It can not be changed by the user.

The following items list the voltage states of the system power. It is also unchangeable.

Note

The hardware monitoring features for temperatures, fans and voltages will occupy the I/O address from 294H to 297H. If you have a network adapter, sound card or other add-on cards that might use those I/O addresses, please adjust your add-on card I/O address, to avoid the use of those addresses.

3-9. Load Fail-Safe Defaults

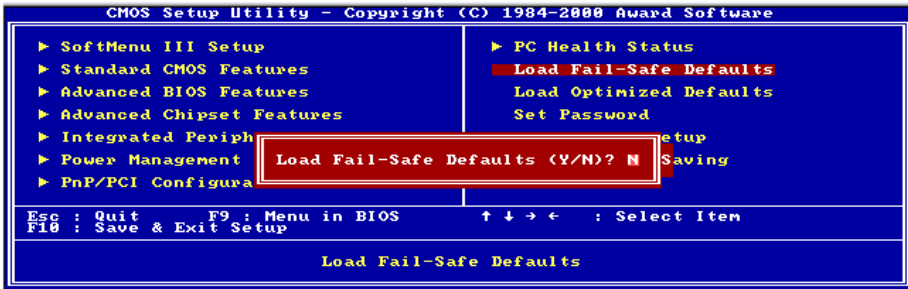

Figure 3-12. Load Fail-Safe Defaults Screen Shot

When you press <Enter> on this item you get a confirmation dialog box with a message similar to:

Load Fail-Safe Defaults (Y/N) ? N

Pressing “Y” loads the BIOS default values for the most stable, minimal-performance system operations.

3-10. Load Optimized Defaults

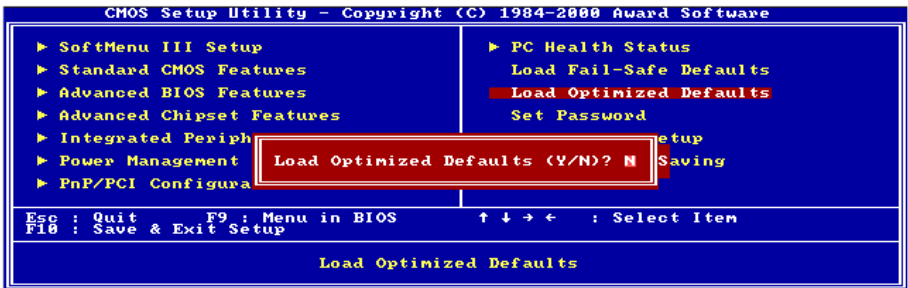

Figure 3-13. Load Optimized Defaults Screen Shot

When you press <Enter> on this item you get a confirmation dialog box with a message similar to:

Load Optimized Defaults (Y/N) ? N

Pressing “Y” loads the default values that are factory settings for optimal performance system operations.

3-11. Set Password



Figure 3-14. Set Password Screen Shot

Set Password: You can enter but do not have the right to change the options of the setup menus. When you select this function, the following message will appear at the center of the screen to assist you in creating a password.

ENTER PASSWORD:

Type the password, up to eight characters in length, and press <Enter>. The password typed now will clear any previously entered password from CMOS memory. You will be asked to confirm the password. Type the password again and press <Enter>. You may also press <Esc> to abort the selection and not enter a password.

To disable a password, just press <Enter> when you are prompted to enter the password. A message will confirm the password will be disabled. Once the password is disabled, the system will boot and you can enter Setup freely.

PASSWORD DISABLED.

When a password has been enabled, you will be prompted to enter it every time you try to enter Setup. This prevents an unauthorized person from changing any part of your system configuration.

Additionally, when a password is enabled, you can also require the BIOS to request a password every time your system is rebooted. This would prevent unauthorized use of your computer.

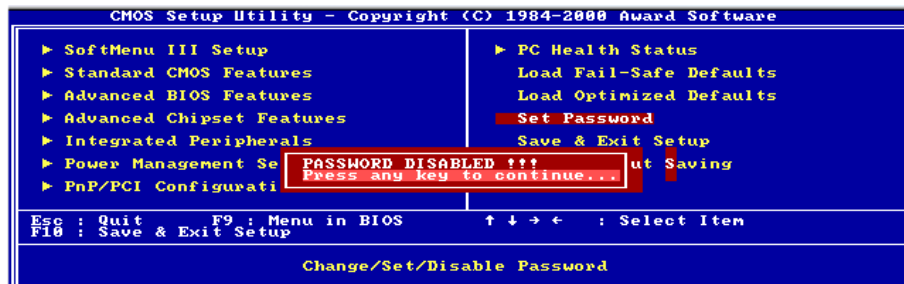

Figure 3-15. Password Disabled Screen Shot

You can determine when the password is required within the BIOS Features Setup Menu and its Security option. If the Security option is set to "System", the password will be required both at boot and at entry to Setup. If it is set to "Setup", the prompting only occurs when trying to enter Setup.

3-12. Save & Exit Setup

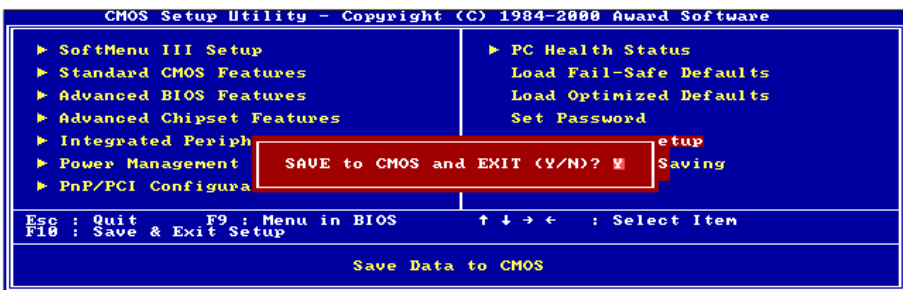

Figure 3-16. Save & Exit Setup Screen Shot

Pressing <Enter> on this item asks for confirmation:

Save to CMOS and EXIT (Y/N)? **Y**

Pressing “Y” stores the selections made in the menus in CMOS - a special section of memory that stays on after you turn your system off. The next time you boot your computer, the BIOS configures your system according to the Setup selections stored in CMOS. After saving the values the system is restarted again.

3-13. Exit Without Saving

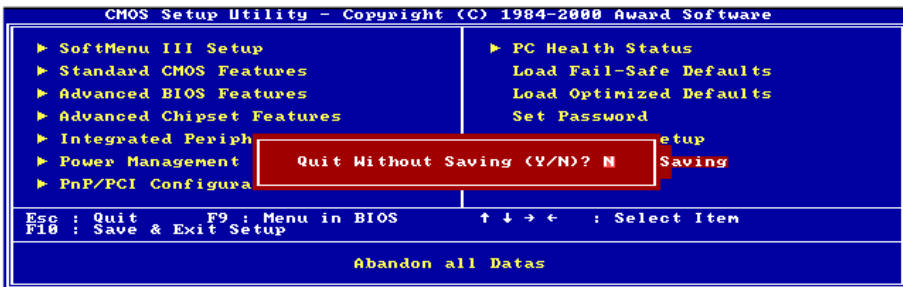

Figure 3-17. Exit Without Saving Screen Shot

Pressing <Enter> on this item asks for confirmation:

Quit without saving (Y/N)? **Y**

This allows you to exit Setup without storing in CMOS any change. The previous selections remain in effect. This exits the Setup utility and restarts your computer.

Chapter 4. RAID Setting Guide (For SA6R Only)

For further information on RAID concept, you can find it on the “**Technological Terms**” on our WEB site, or you can search the related information on the Internet.

4-1. The features of RAID on the SA6R

The SA6R supports the RAID operation of “**Striping (RAID 0)**”, “**Mirroring (RAID 1)**”, or “**Striping/Mirroring (RAID 0+1)**”. For the striping operation, the identical drives can read and write data in parallel to increase performance. The Mirroring operation creates a complete backup of your files. Striping with Mirroring operation offers both high read/write performance and fault tolerance although requiring 4 hard disks in order to do so.

4-2. Setup RAID on the SA6R

Enter Advanced BIOS Features in the BIOS setup. Change the settings of First Boot Device, Second Boot Device and Third Boot Device to read ATA-100. See the figure below:

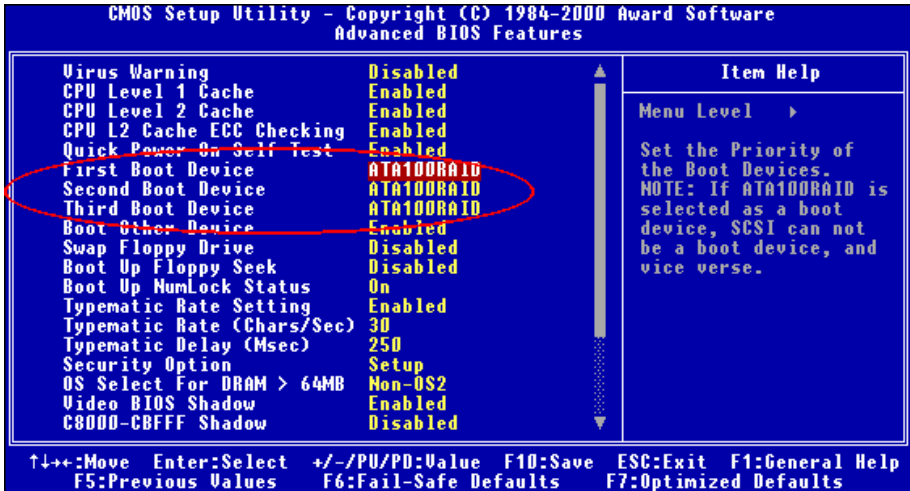

4-3. The BIOS Setting Menu

Reboot your system. Press <CTRL> and <H> key while booting up the system to enter the BIOS setting menu. The main menu of BIOS Setting Utility appears as shown below:

```

HPT3xx <BIOS Setting Utility>

Menu
1. Create RAID
2. Delete RAID
3. Duplicate Mirror Disk
4. Set Drive Mode
5. Select Boot Disk

Help
Create a RAID Array with the
hard disks attached to the
HPT3xx

F1: View Array Status
↑,↓: Move to next item
Enter: Confirm the selection
Esc: Return to top menu

Channel Status
Channel Drive Name Mode Size (M) Status
Primary Master QUANTUM FIREBALL CR4.3 UDMA4 4209 HDD0
Primary Slave No Drive
Secondary Master QUANTUM FIREBALL CR4.3 4209 HDD1
Secondary Slave No Drive

(C)1999-2000. HighPoint Technologies, Inc.
All rights reserved

```

For selecting the option in the menu, you may:

- Press **F1** to view array status.
- Press **↑ ↓** (up, down arrow) to choose the option you want to confirm or to modify.
- Press **Enter** to confirm the selection.
- Press **Esc** to return to top menu.

Note

If you want to create a RAID 0 (striping) array or RAID 0+1 array, all the data stored in the hard disks will first be erased! Please backup the hard disk data before starting to create these RAID arrays.

If you want to create a RAID 1 (mirroring) array, please be sure which hard disk is the source disk and which one is the destination disk. If you make a mistake, you may copy the blank data to the source disk, which will result in both hard disks becoming blank!

Option 1: Create RAID

This item allows you to create a RAID array. After you had selected the function you want in the main menus, you may press the <Enter> key to enter the sub menu as shown below:

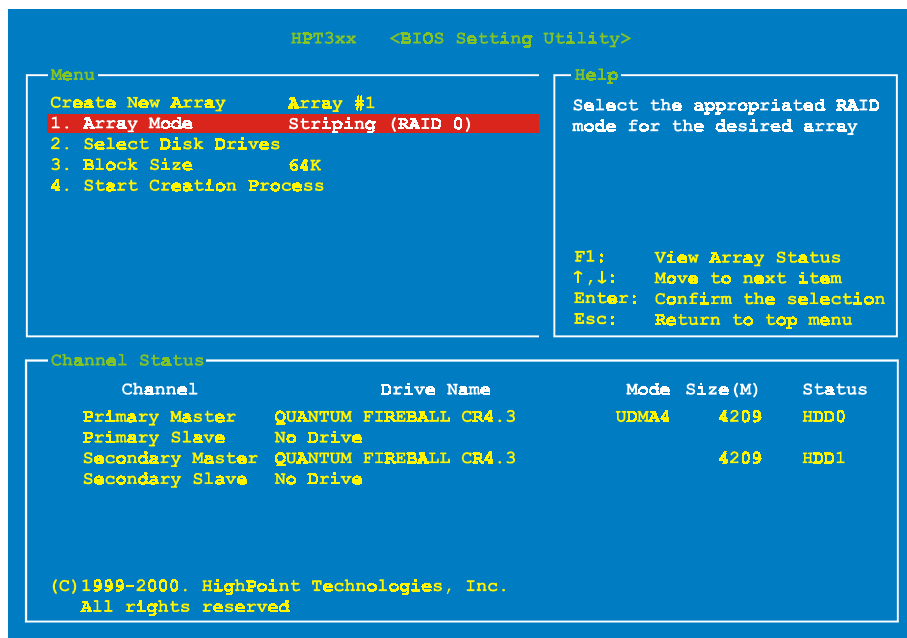

Array Mode:

This item allows you to select the appropriate RAID mode for the desired array. There are four modes to choose.

Note

It is highly recommended to attach hard disks with the same model in reaching the RAID performance.

- **Striping (RAID 0):**
This item is recommended for high performance usage. Requires at least 2 disks.
- **Mirror (RAID 1):**
This item is recommended for data security usage. Requires at least 2 disks.
- **Striping and Mirror (RAID 0+1):**
This item is recommended for data security and high performance usage. Allows Mirroring with a Strip Array. Require four drivers only.
- **Span (JBOD):**
This item is recommended for high capacity without redundancy or performance features usage. Requires at least 2 disks.

Note

When you choose to create RAID 1 and your source disk is not empty. You have to do the **Duplicate Mirror Disk** to make whole data copy to the destination disk. Otherwise, it will only copy the partition table to the destination disk, not physical data.

Select Disk Drives:

This item allows you to select the disk drives to be used with the RAID array.

Block Size:

This item allows you to select the block size of the RAID array. There are five options: 4K, 8K, 16K, 32K, and 64K.

Start Creation Process:

After you have made your selection, choose this item and press <Enter> to start creation.

Option 2: Delete RAID

This item allows you to remove a RAID Array on this IDE RAID controller card.

Note: After you have made and confirmed this selection, all the data stored in the hard disk will be lost. (The entire partition configuration will be deleted too.)

Option 3: Duplicate Mirror Disk

This item allows you to select the disk you wish to duplicate in preparation for a “Mirror Disk Array”.

After you have selected the function you want in the main menu, you may press the <Enter> key to enter the sub menu as shown below:

```

HPT3xx  <BIOS Setting Utility>

Menu-----
1. Select Source Disk: None
2. Select Target Disk: None
3. Start Duplication Process

Help-----
Select the Source Disk.
The Source Disk Size must be
smaller or equal to the
Target Disk Size

F1:    View Array Status
↑,↓:   Move to next item
Enter: Confirm the selection
Esc:   Return to top menu

Channel Status-----

Channel      Drive Name          Mode  Size (M)  Status
Primary Master  QUANTUM FIREBALL CR4.3  UDMA4  4209  HDD0
Primary Slave   No Drive
Secondary Master QUANTUM FIREBALL CR4.3  4209  HDD1
Secondary Slave No Drive

(C)1999-2000. HighPoint Technologies, Inc.
All rights reserved

```

- **Select Source Disk:**

This item is to select the source disk. The size of source disk must be smaller or equal to the one of target disk.

- **Select Target Disk:**

This item is to select the target disk. The size of target disk must be greater or equal to the one of source disk.

- **Start Duplicating Process:**

After you had selected this item, the BIOS setting will take up to 30 minutes to run the duplication. Please wait or you may press <Esc> to cancel.

Option 4: Set Drive Mode

This item allows you to select the drive transfer mode for the hard disk(s).

Use the up/down arrow to select the menu option to “**Set Drive Mode**” and press <Enter>. In the Channel Status, select the channel you would like to set and press <Enter>, there will comes out an asterisk mark in the parentheses indicating that the channel selection had be done. Choose the mode from the pop-up menu. You can choose from PIO 0 ~ 4, MW DMA 0 ~ 2, and UDMA 0 ~ 5.

Option 5: Select Boot Disk

This item allows you to select the boot disk among the hard disk(s).

The screenshot shows the HPT3xx BIOS Setting Utility interface. At the top, it displays 'HPT3xx <BIOS Setting Utility>'. Below this, there are two main sections: 'Menu' and 'Help'.

The 'Menu' section lists five options:

1. Create RAID
2. Delete RAID
3. Duplicate Mirror Disk
4. Set Drive Mode
5. Select Boot Disk

 The fifth option, '5. Select Boot Disk', is highlighted with a red background.

The 'Help' section provides instructions:

Select the boot disk among the hard disk(s) attached to the HPT3xx

Fl: View Array Status
 ↑,↓: Move to next item
 Enter: Confirm the selection
 Esc: Return to top menu

Channel Status

Channel	Drive Name	Mode	Size (M)	Status
(*) Primary Master	QUANTUM FIREBALL CR4.3	UDMA4	4209	HDD0
Primary Slave	No Drive			
() Secondary Master	QUANTUM FIREBALL CR4.3		4209	HDD1
Secondary Slave	No Drive			

(C)1999-2000. HighPoint Technologies, Inc.
 All rights reserved

Use the up/down arrow to select the menu option to “**Select Boot Disk**” and press <Enter>. In the Channel Status, select the channel you would like to set as bootable disk and press <Enter>, there will comes out an asterisk mark in the parentheses indicating that the channel selection had be done.

Chapter 5. HPT370 Software Installation (For SA6R Only)

Here we will show you the driver installation procedure under various operating systems.

5-1. DOS[®] Installation

This IDE RAID BIOS supports DOS[®] 5.x (or above) and Windows[®] 3.1x without the software driver.

5-2. Windows[®] 9x Installation

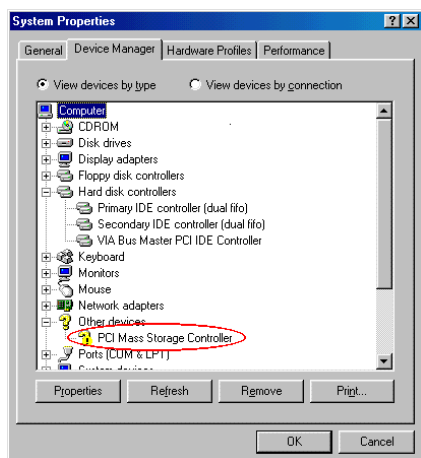

1. After the Windows[®] 9x operating system had been installed and rebooted successfully, go to the “Control Panel” → “System Properties” → “Device Manager”. You can see the driver is not yet installed, and there is a device of “? PCI Mass Storage Controller” under “Other devices”.

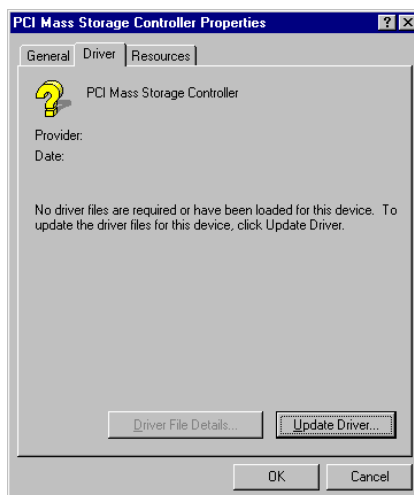

2. Click right button of your mouse on the “? PCI Mass Storage Controller”, and then go to “Driver” tab. Click “Update Driver” to go to next step.



3. The wizard is going to install the PCI Mass Storage Controller. Click “**Next >**” to go to next step.



4. Choose “**Display a list of all the drivers in a specific location...**” and click “**Next >**” to go on.

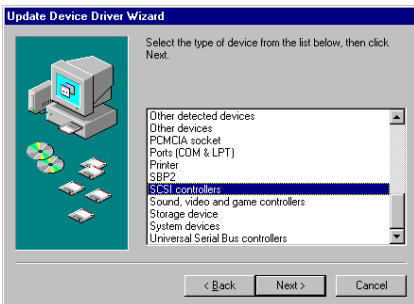

5. Choose “**SCSI controllers**” and click “**Next >**” to go on.

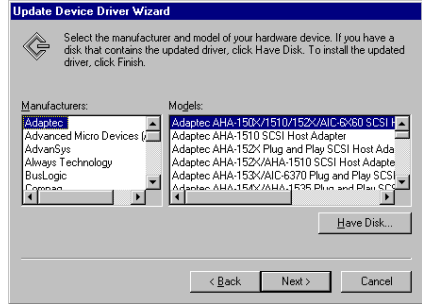

6. Click “**Have Disk...**” to go on.

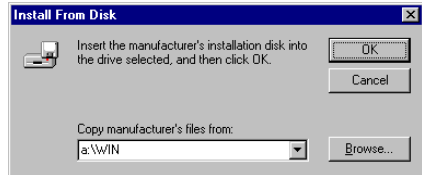

7. Insert the driver disk and type the path in the text box “**a:\WIN**” (“**a:**” is your floppy drive letter), or “**D:\Drivers\HPT370\Win9x**” (D:\ is your CD-ROM drive letter).

Click “**OK**” to go on.

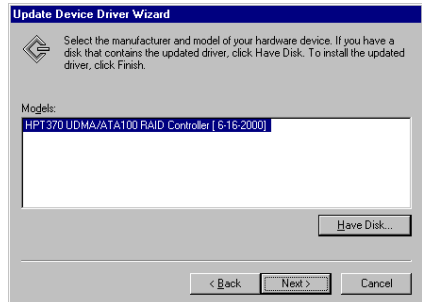

8. Choose “**HPT370 UDMA/ATA100 RAID Controller**” and click “**Next >**” to go on.



9. Windows is now ready to install the driver. Click “**Next >**” to go on.

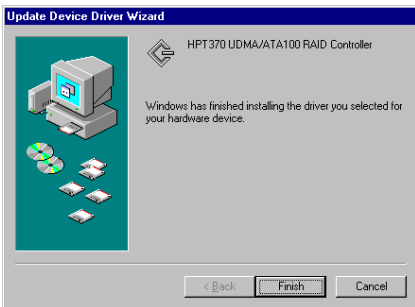

10. Windows has finished installing the driver. Click “**Finish**” to end the installation.

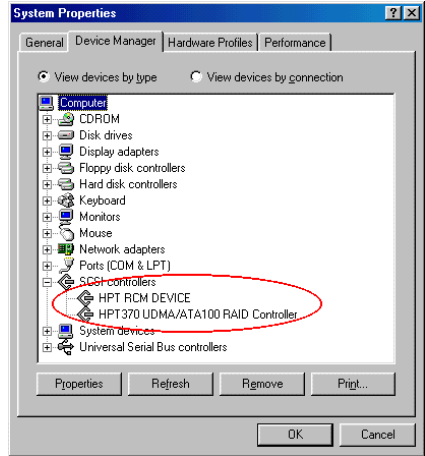

11. After rebooting the system, go to the “**Control Panel**” → “**System Properties**” → “**Device Manager**”. Now you can see the driver is installed under the item of “**SCSI controllers**”.

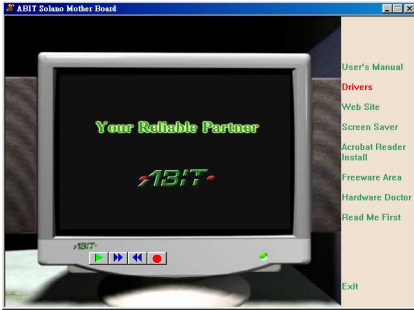

Or you can insert the SA6/SA6R CD-Title into your CD-ROM drive, it should execute the program automatically. If not, you can go to the CD location and execute the execution file at the main directory of this CD-Title. After it has been executed you will see the screen below. Move the cursor to the “Drivers” and click on it. This will take you to the next screen.

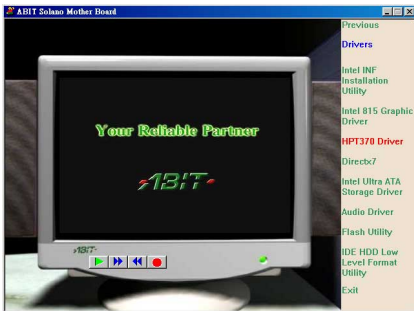

1. Move the cursor to “HPT370 Driver” and click on it. Go to the next screen.

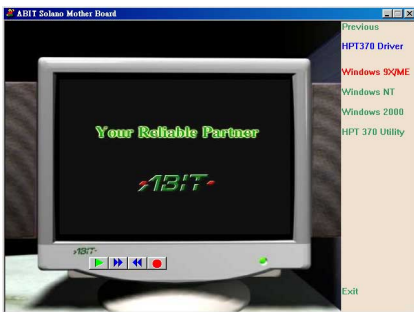

2. Move the cursor to “Windows 9X/ME” and click on it. Go to the next screen.

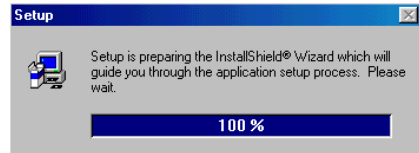

3. Now you will see the install shield loading.

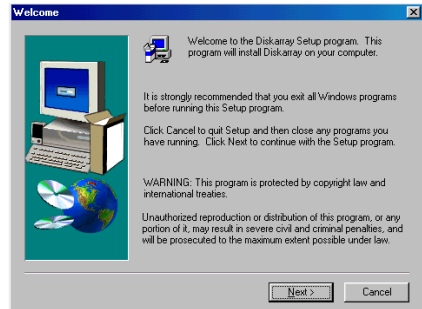

4. You will now see the welcome screen and its dialogue box. Click “Next>” to start install drivers.

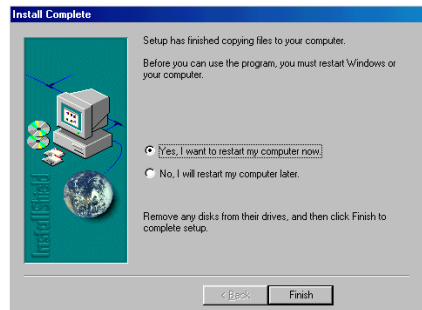

5. When the installation is complete, the installer will ask you to restart your computer. We suggest that you choose “Yes, I want to restart my computer now” then click the “Finish” button to restart your computer to finish the driver updates.

When system reboot, it will start update several driver, you just follow the instruction on screen and click “Next” button, then you can finish the process and reboot again.

After reboot, your HPT370 driver will be successfully installed.

5-3. Windows NT[®] 4.0 Installation

Installing drivers during Windows[®] NT installation:

If the NT 4.0 is first installed on the ATA100 drive connected to the SA6R motherboard, follow the following installation procedure:

1. Set your system to boot from “Drive A” and then insert the Windows[®] NT installation diskette 1/3. Power on your computer.

Installation Note

If you are installing NT 4.0 from a CD-ROM, please **press the <F6> key** immediately when the message “**Setup is inspecting your computer’s hardware configuration...**” appears, and then press <S> to configure the HPT 370 controller.

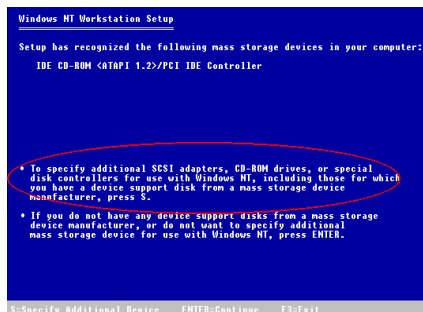

2. The setup program will display a message about installing mass storage devices (see figure left) while you install NT4.0. Please press <S> to install the HPT370 driver

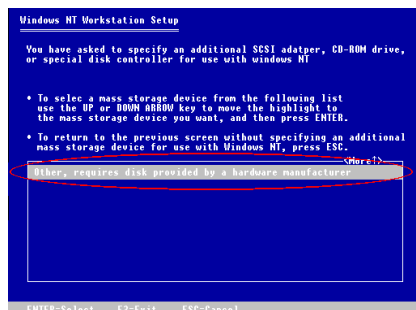

3. Select “**Other, requires disk provided by a hardware manufacturer**”, and then press <Enter>.

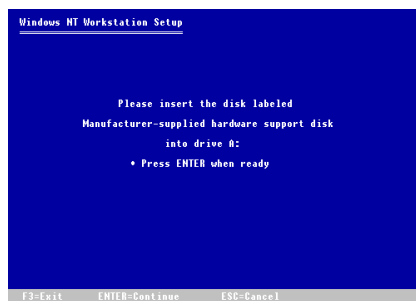

4. Insert the driver disk into drive A and press <Enter>.

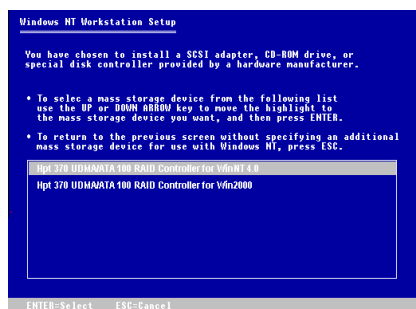

5. Use the UP or DOWN arrow key to move the highlight to the mass storage device you want and press <Enter> to continue setup.



6. Windows® NT setup has recognized this HPT 370 IDE RAID controller

Press <Enter> to continue setup.

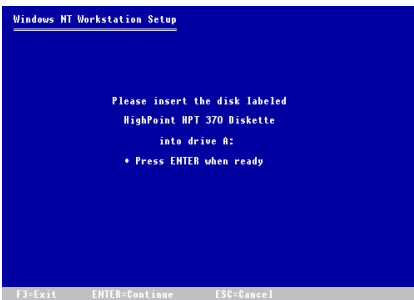

7. After you configure your hard disk and specify the installation path, the NT setup will ask you to insert this HPT 370 IDE RAID controller driver disk into drive A again. Insert the driver disk, and then press <Enter> to continue setup.

If you have followed the steps described above, you should be finished installing your HPT 370 controller. For the rest of Windows® NT installation steps, please follow the instructions displayed in the NT setup program.

Installing drivers with existing Windows® NT:

If there is an existing NT 4.0 file system, you can install the HPT 370 IDE RAID controller into the existing system by the following procedure:



1. Go to “Control Panel”, and then enter “SCSI Adapters”.

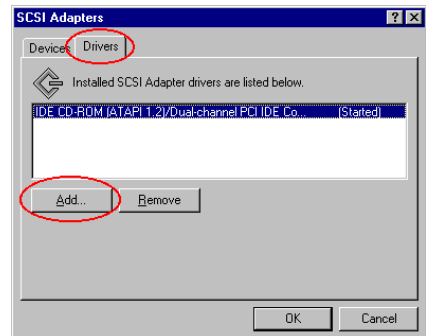

2. Select “Drivers”, and then click “Add...”.

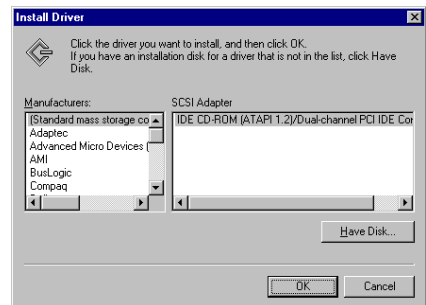

3. Click “Have Disk...” to go on.

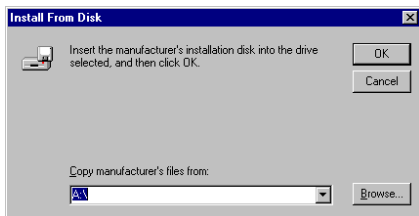

4. Insert this HPT 370 IDE RAID controller driver disk into drive A, and then click “OK”.

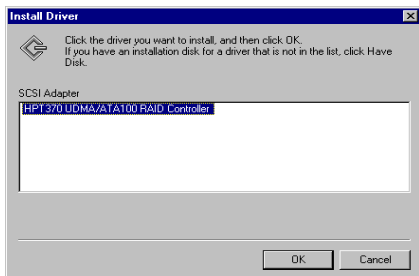

5. Click “OK” to go on.

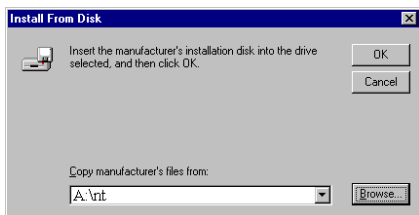

6. Insert the driver disk and type the path in the text box “A:\nt” (“a:\” is your floppy drive letter), or “E:\Drivers\HPT370\nt” (E:\ is your CD-ROM drive letter).

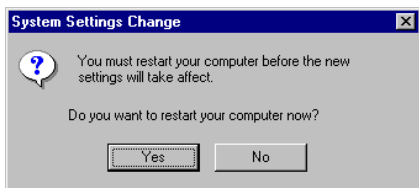

7. Click “Yes” to restart your computer.

5-4. Windows® 2000 Installation

Note

If you want to install the Windows® 2000 operating system on the hard drive utilizing the HPT 370 controller, please refer to the NT4.0 installation procedure. The following procedure is used only when you don't want to install the Windows® 2000 operating system onto the hard drive utilizing the HPT 370 controller.



1. Reboot the system. Windows will detect the new hardware automatically.

Click “**Next>**” to go to the next step.



2. Choose “**Display a list of all the drivers in a specific location...**” and click “**Next >**” to go on.

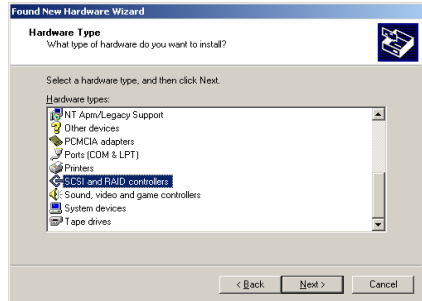

3. Choose “**SCSI and RAID controllers**” and click “**Next >**” to go on.

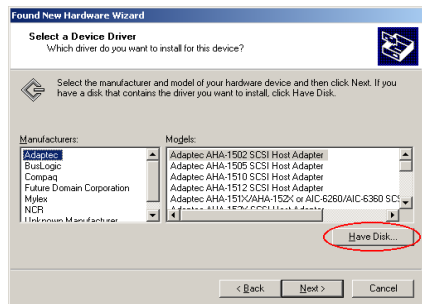

4. Click “**Have Disk...**” to go on.

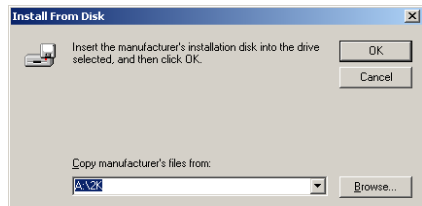

5. Insert the driver disk and type the path in the text box “**A:\2K**” (“a:\” is the floppy drive letter), or “**E:\Drivers\HPT370\Win2k**” (E:\ is the CD-ROM drive letter).

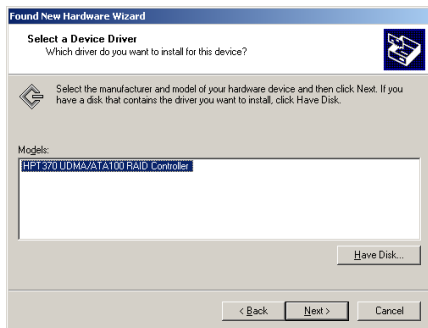

6. Choose “HPT370 UDMA/ATA100 RAID Controller” and click “Next >” to go on.

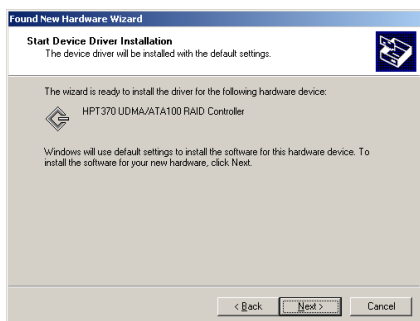

7. Windows is now ready to install the driver. Click “Next >” to go on.

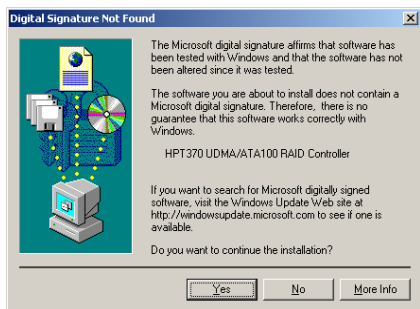

8. Click “Yes >” to go on.

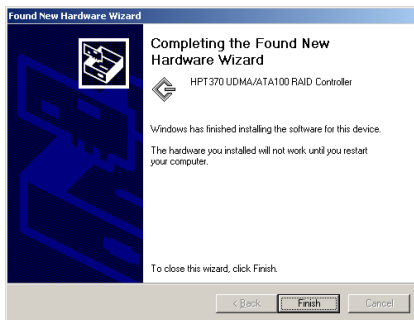

9. Windows has finished installing the driver. Click “Finish” to end the installation.

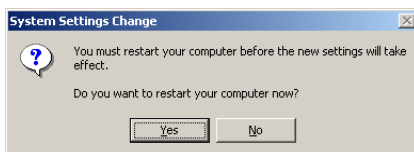

10. Click “Yes” to restart the system.

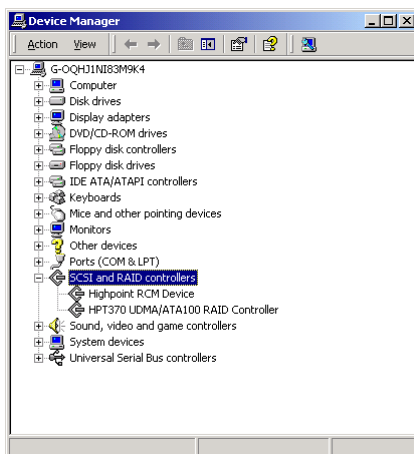

11. Go to the “Control Panel” → “System Properties” → “Device Manager”. Now you can see the driver is installed under the item of “SCSI and RAID controllers”.

5-5. HPT370 Utility Installation Guide

In order to provide you with the on-screen monitoring function about the device information of disk array, you may install the “**HPT370 Utility**” onto your system. Please insert the SA6/SA6R CD-Title into your CD-ROM drive. It should execute the program automatically. If not, you can go to the CD location and execute the execution file from the main directory of the CD-Title. After it is executed, you will see the screen shot below.

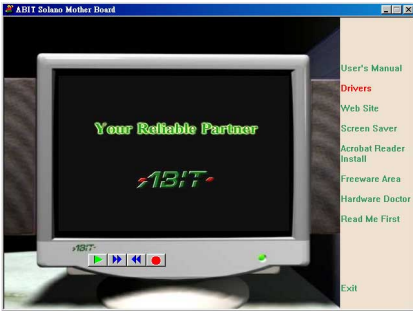

1. Move the cursor to “**Driver**” and click on it to go to the next step.

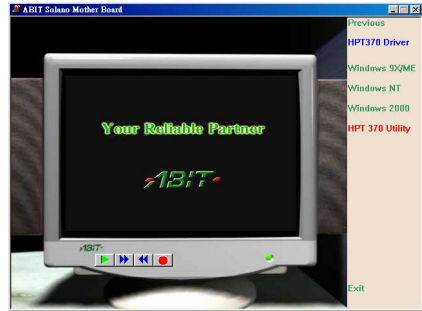

3. Move the cursor to “**HPT370 Utility**” and click on it to go to the next step.

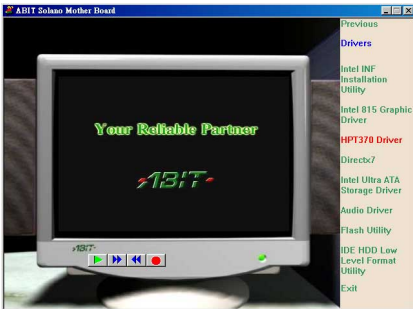

2. Move the cursor to “**HPT370 Driver**” and click on it to go to the next step.

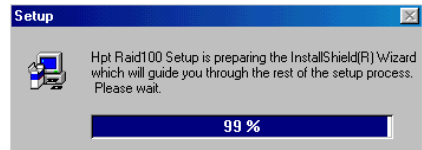

4. Now you will see the install shield loading.

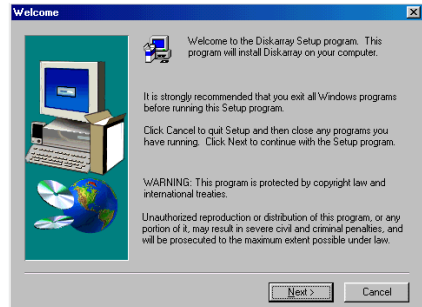

5. You will now see the welcome screen and its dialogue box. Click “**Next>**” to go on.

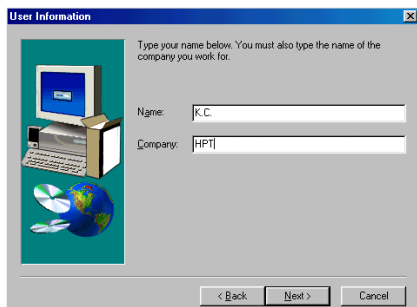

6. Type in the information of your name and company and then click “**Next>**” to go on.

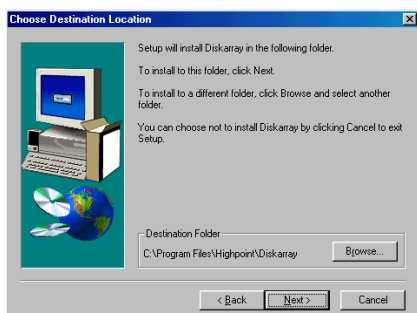

7. Now you can choose the folder for the destination location you want. We suggest you use the default folder as the destination location. When you are sure of the folder, click “**Next>**” to go on.

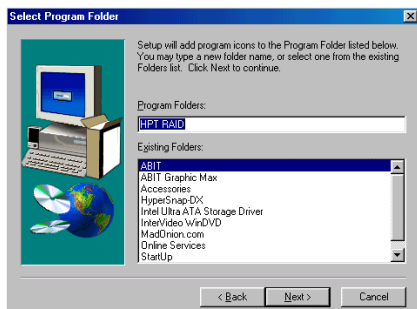

8. Now you can select the program folder. The setup wizard will add program icons to those program folders listed. Click “**Next>**” to go on.

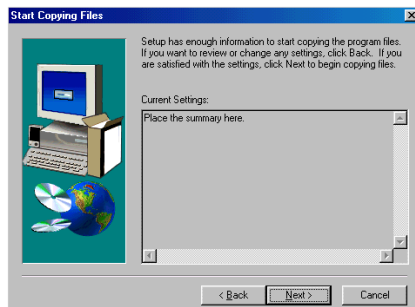

9. The system will start copying files. Click “**Next>**” to go on.

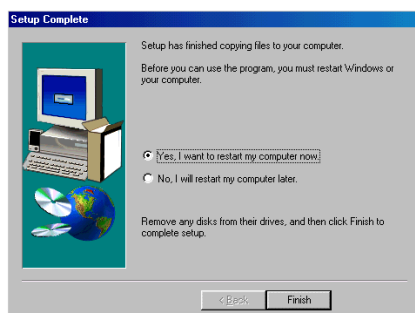

10. When the installation is completed, choose “**Yes, I want to restart my computer now.**” In the check box and click “**Finish**” to end the setup.

After the system restart, you can run this “**Stripe & Mirror Settings**” monitoring program.

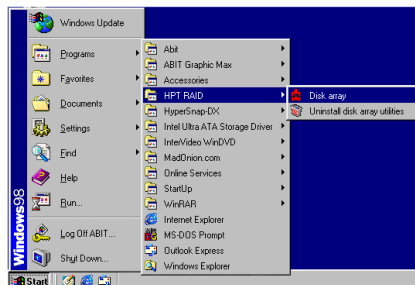

11. Move the cursor to where the execution file is, shown left.

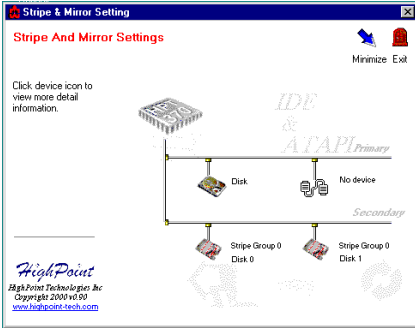

12. The monitoring screen pops up. Note that there will be a shortcut icon appears in the tool bar. This is used for bringing out the screen again after you had clicked the “Minimize” icon on the upper right corner of the screen. This short cut icon will disappear after you click the “Exit” icon.

Now you are in the monitoring screen. Your current device allocation is viewable at a glance. Move the cursor to the drive icon you want to view and click on it.

Appendix A. Installing the INF Utility for Windows® 98 SE

After you've installed Windows® 98, you need to install the driver for your IDE & USB devices. We will show you step by step in the following section on how to do this.

Note

You have to install the INF Installation Utility before you install the VGA and audio driver. After installing Windows, the quality of your display will be poor because it will be set to 640*480 and 16 color. For the best screen capture quality, install the VGA driver and set the desktop to 800*600 using True Color.

Note

Details of the Windows® 98 SE operating system will not be mentioned in this manual. If you have any problems with Windows® 98 SE installation, operations and settings, please refer to your Windows® 98 SE user's manual or other resources provided by Microsoft® Corporation.

Insert the SA6/SA6R CD-Title into your CD-ROM drive, it should execute the program automatically. If not, you can go to the CD location and execute the execution file at the main directory of this CD-Title. After it has been executed you will see the screen below.

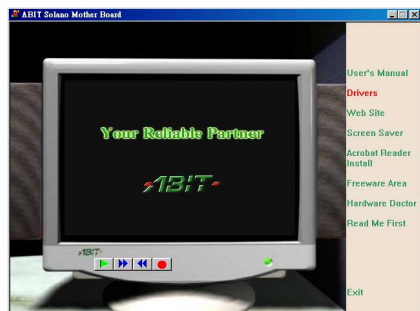

1. Move the cursor to “**Drivers**” and click on it to go on.

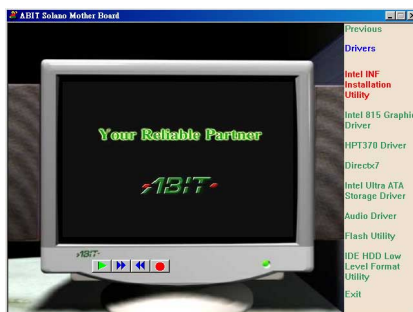

2. Move the cursor to “**Intel INF Installation Utility**” and click on it to go on.

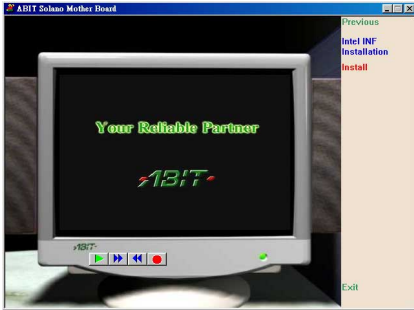

3. Move the cursor to “Install” and click on it to go on.

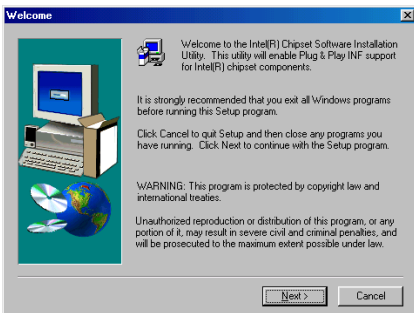

4. The Welcome screen appears. Click “Next>” to go on.

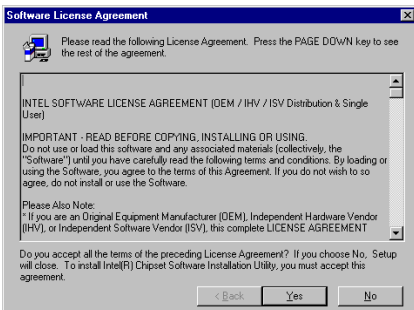

5. The License screen appears. Read it and click “Yes” to go on.

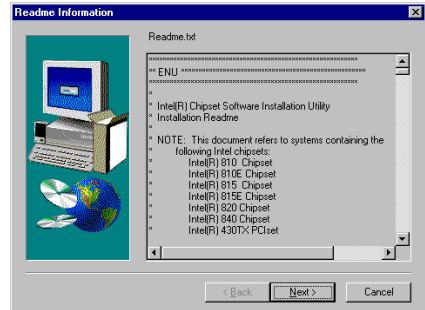

6. Read this “Readme Information” and click “Next>” to go on.

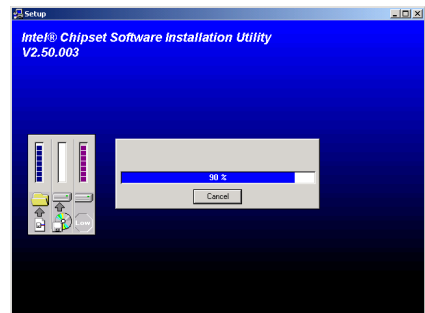

7. The install shield is now loading.

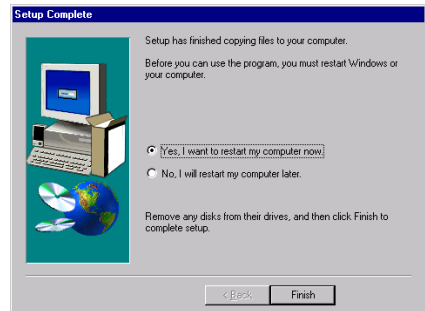

8. Choose “Yes, I want to restart my computer now”, and click “Finish” to end the installation.

Appendix B. Installing the Audio Driver for Windows® 98 SE

We will show you how to install the audio driver for Windows® 98 SE operating system.

Insert the SA6/SA6R CD-Title into your CD-ROM drive, it should execute the program automatically. If not, you can go to the CD location and execute the execution file at the main directory of this CD-Title. After it has been executed you will see the screen below.

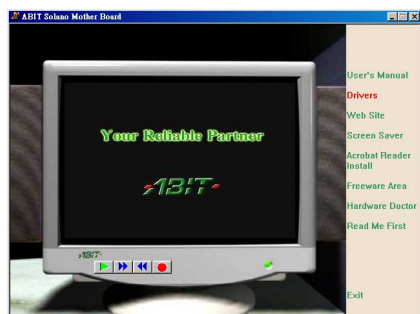

1. Move the cursor to “Drivers” and click on it to go on.



2. Move the cursor to “Audio Driver” and click on it to go on.

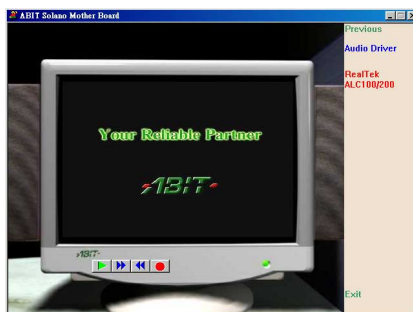

3. Move the cursor to “RealTek ALC100/200” and click on it to go on.

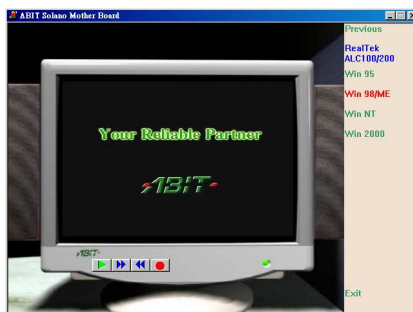

4. Move the cursor to “Win 98/ME” and click on it to go on.

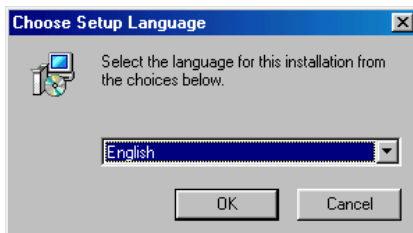

5. Choose the language for this installation.

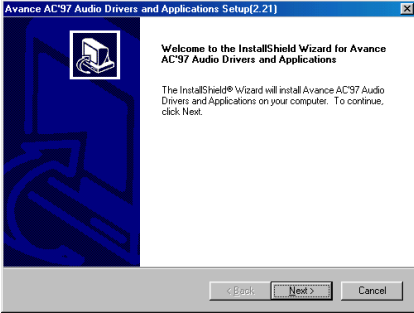

6. The Welcome screen appears. Click “Next>” to go on.

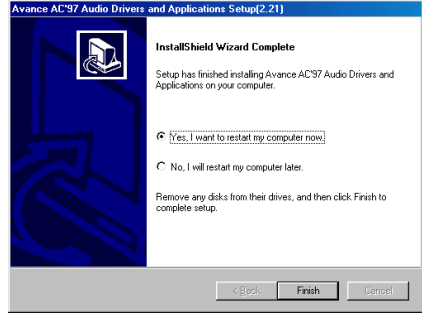

10. Choose “Yes, I want to restart my computer now”, and click “Finish” to end the installation.

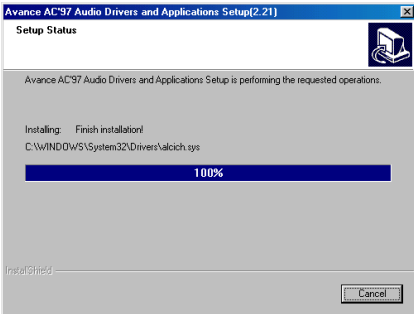

7. The install shield is now loading.

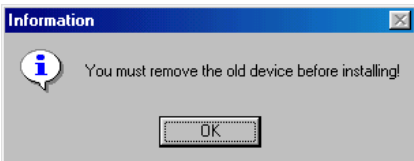

8. Click “OK” to go on.

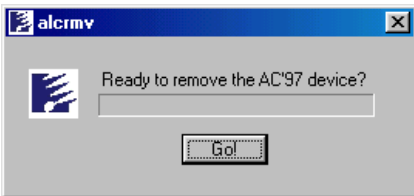

9. Click “Go!” to go on.

Appendix C. Installing the ATA Utility for Windows® 98 SE

In this section we will detail the Ultra ATA installation procedure.

Insert the SA6/SA6R CD-Title into your CD-ROM drive, it should execute the program automatically. If not, you can go to the CD location and execute the execution file at the main directory of this CD-Title. After it has been executed you will see the screen below.

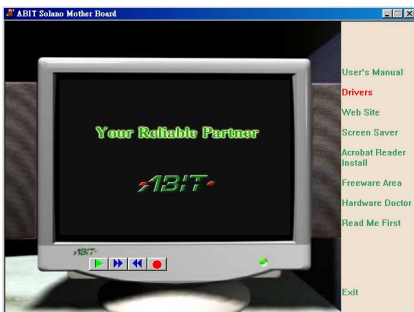

1. Move the cursor to “Drivers” and click on it to go on.



2. Move the cursor to “Intel Ultra ATA Storage Driver” and click on it to go on.

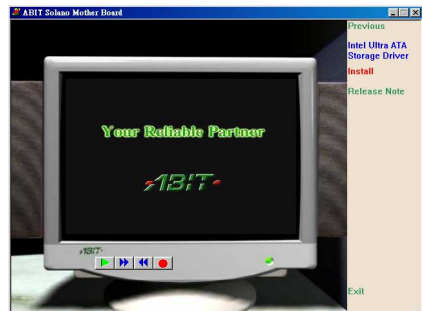

3. Move the cursor to “Install” and click on it to go on.

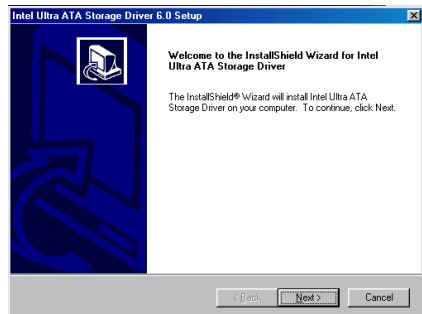

4. The Welcome screen appears. Click “Next>” to go on.

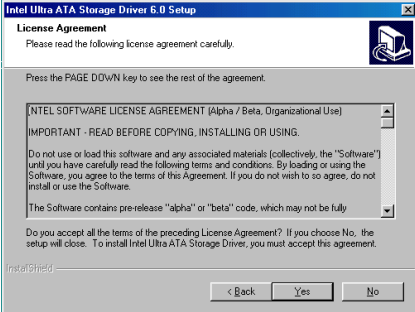

5. The License screen appears. Read it and click **“Yes”** to go on.

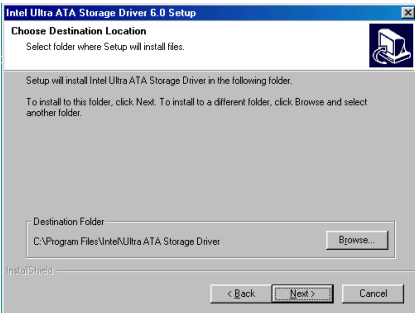

6. Now you can choose the folder for the destination location you want to install the driver. We suggest you use the default folder as the destination. When you have decided on the destination, click **“Next>”**.

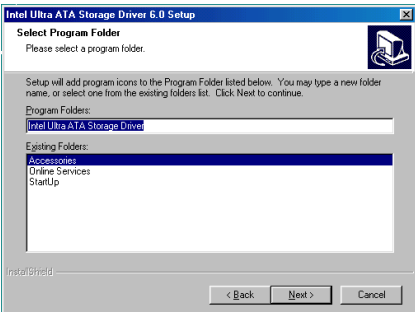

7. Now you can choose the program folder. The Setup will add program icons to those program folders listed. Click **“Next>”** to go on.

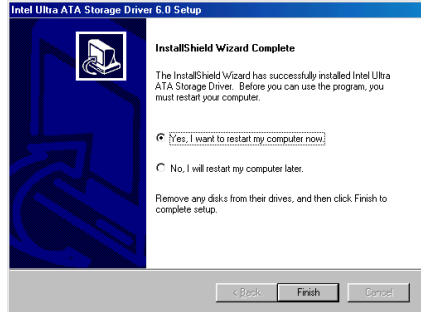

8. Choose **“Yes, I want to restart my computer now”**, and click **“Finish”** to end the installation.

Appendix D. Installing the Audio Driver for Windows® NT 4.0 Server/Workstation

In this section we will show you how to install the audio driver to your Windows® NT 4.0 Server/Workstation operating system. Before you install the audio driver, please install Windows® NT 4.0 Service Pack 4 (or the latest version) first. Then you can install the audio driver.

Insert the SA6/SA6R CD-Title into your CD-ROM drive, it should execute the program automatically. If not, you can go to the CD location and execute the execution file at the main directory of this CD-Title. After it has been executed you will see the screen below.

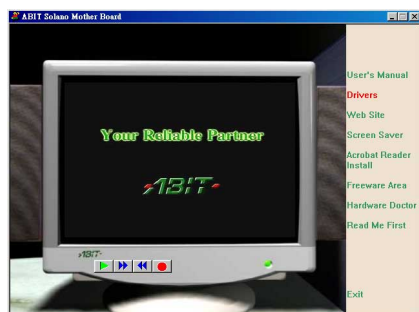

1. Move the cursor to “Drivers” and click on it to go on.

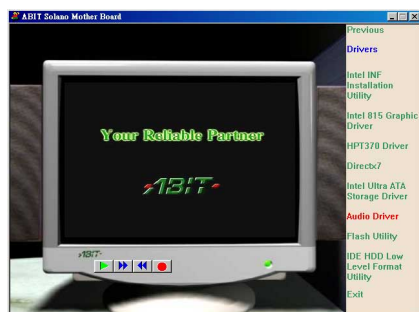

2. Move the cursor to “Audio Driver” and click on it to go on.

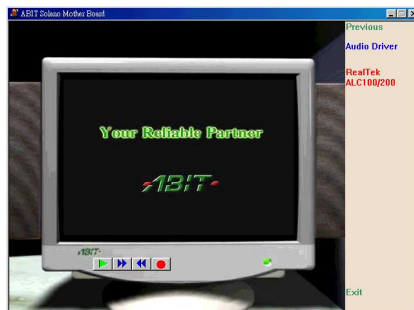

3. Move the cursor to “RealTek ALC100/200” and click on it to go on.

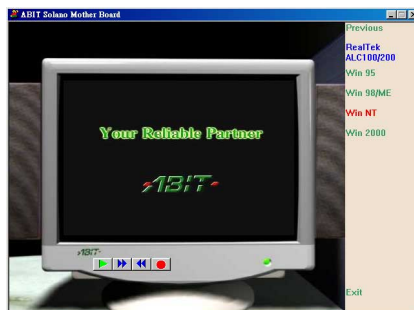

4. Move the cursor to “Win NT” and click on it to go on.

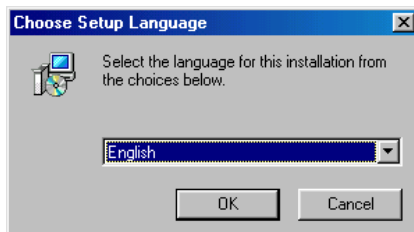

5. Choose the language for this installation.

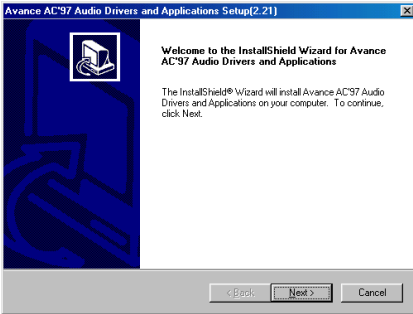

6. The Welcome screen appears. Click “Next>” to go on.

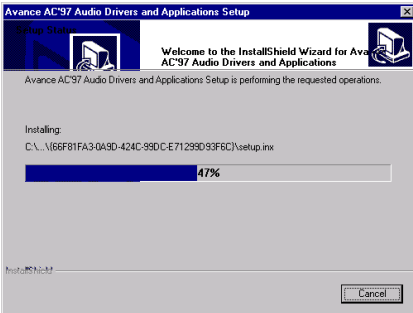

7. The install shield is now loading.

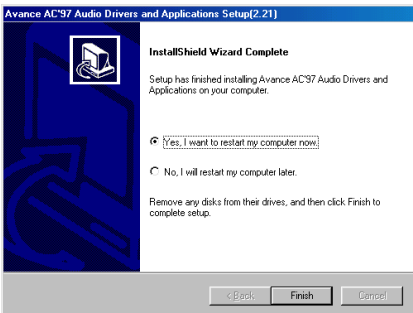

8. Choose “Yes, I want to restart my computer now”, and click “Finish” to end the installation.

Appendix E. Installing the ATA Utility for Windows® NT 4.0 Server/Workstation

In this section we will show you how to install the ATA Utility to your Windows® NT 4.0 Server/Workstation operating system.

Insert the SA6/SA6R CD-Title into your CD-ROM drive, it should execute the program automatically. If not, you can go to the CD location and execute the execution file at the main directory of this CD-Title. After it has been executed you will see the screen below.

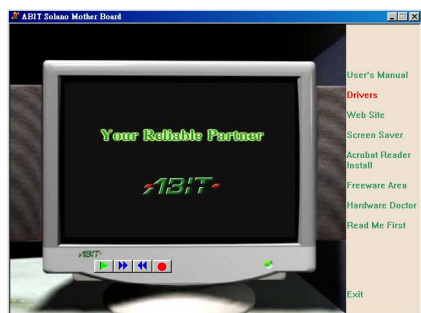

1. Move the cursor to “Drivers” and click on it to go on.

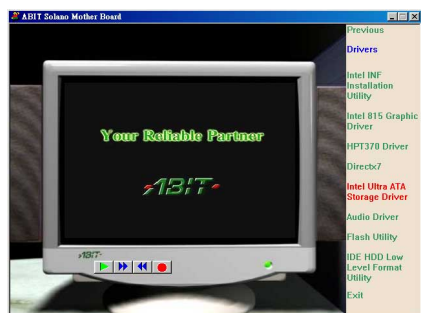

2. Move the cursor to “Intel Ultra ATA Storage Driver” and click on it to go on.

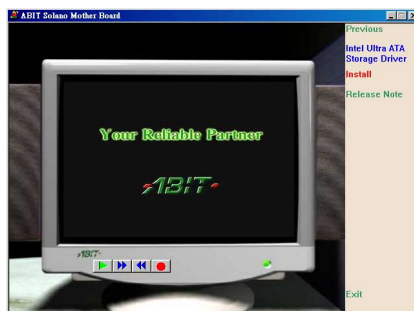

3. Move the cursor to “Install” and click on it to go on.

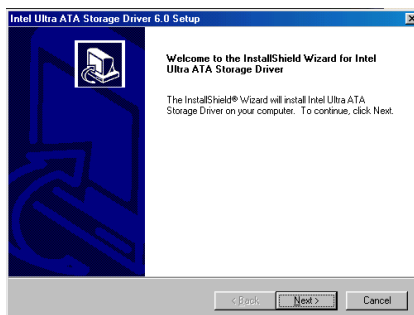

4. The Welcome screen appears. Click “Next” to go on.

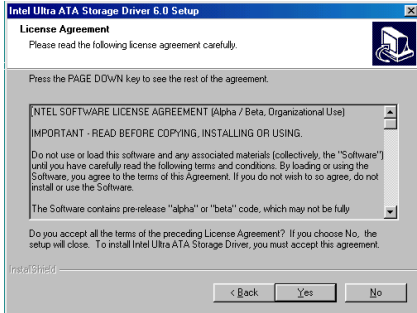

5. The License screen appears. Read it and click **“Yes”** to go on.

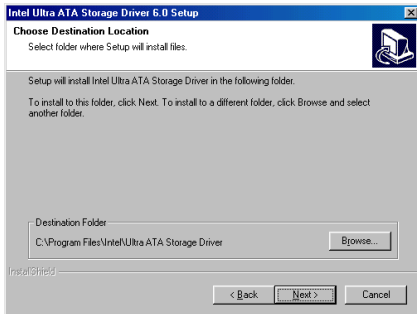

6. Now you can choose the folder for the destination location you want to install the driver. We suggest you use the default folder as the destination. When you have decided on the destination, click **“Next>”** to go on.

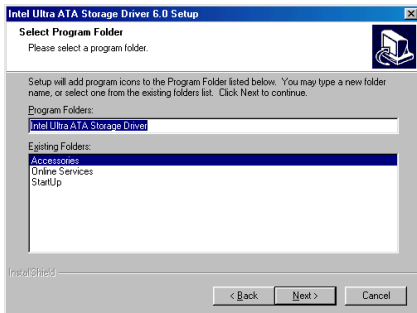

7. Now you can choose the program folder. Setup will add program icons to those program folders listed. Click **“Next>”** to go on.

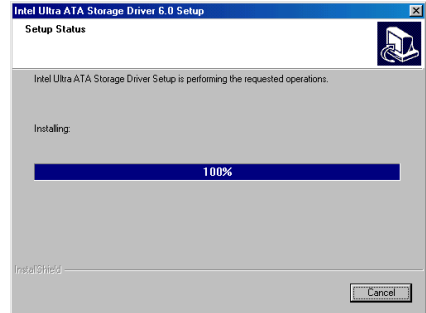

8. The install shield is now loading.

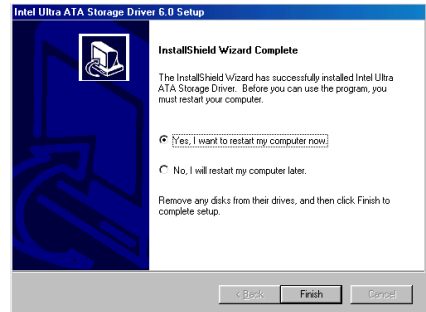

9. Choose **“Yes, I want to restart my computer now”**, and click **“Finish”** to end the installation.

Appendix F. Installing the INF Utility for Windows® 2000

In this section we will show you how to install the ATA Utility to your Windows® 2000 operating system.

Note

The details of the Windows® 2000 operating system are not mentioned in this manual. If you have any problems with the settings, operating or installing Windows® 2000, please refer to your Windows® 2000 user's manual or other resources provided by Microsoft® Corporation.

Insert the SA6/SA6R CD-Title into your CD-ROM drive, it should execute the program automatically. If not, you can go to the CD location and execute the execution file at the main directory of this CD-Title. After it has been executed you will see the screen below.

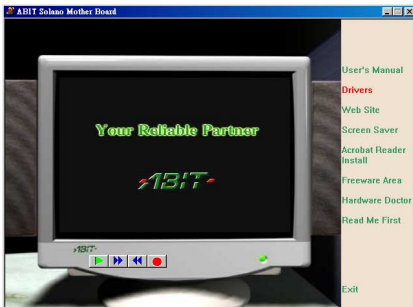

1. Move the cursor to “Drivers” and click on it to go on.

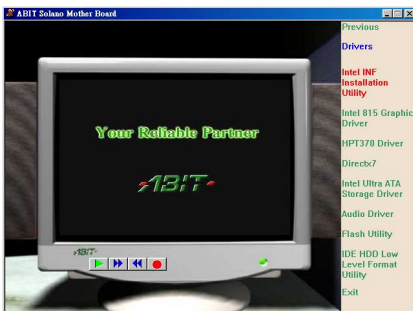

2. Move the cursor to “Intel INF Installation Utility” and click on it to go on.

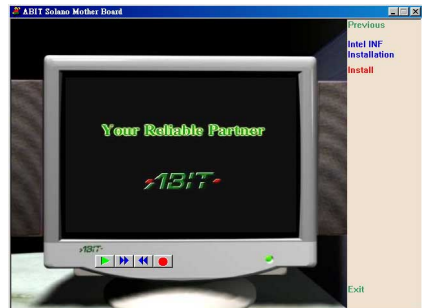

3. Move the cursor to “Install” and click on it to go on.



4. The welcome screen appears. Click “Next>” to go on.

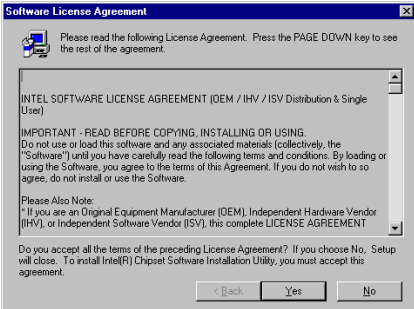

5. The license screen appears. Read it and click “Yes” to go on.



8. Choose “Yes, I want to restart my computer now”, and click “Finish” to end the installation.

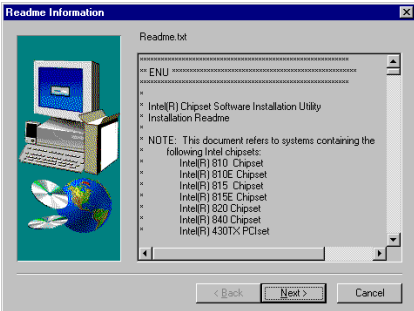

6. Read this “Readme Information” and click “Next>” to go on.

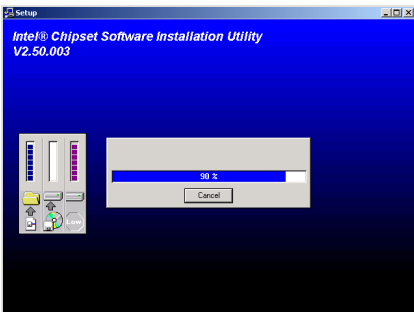

7. The install shield is now loading.

Appendix G. Installing the Audio Driver for Windows® 2000

In this section we will show you how to install the Audio Driver to your Windows® 2000 operating system.

Note

There is no need to install audio driver as the Audio Codec is already provided by Windows® 2000.

Insert the SA6/SA6R CD-Title into your CD-ROM drive, it should execute the program automatically. If not, you can go to the CD location and execute the execution file at the main directory of this CD-Title. After it has been executed you will see the screen below.



1. Move the cursor to “Drivers” and click on it to go on.



2. Move the cursor to “Audio Driver” and click on it to go on.

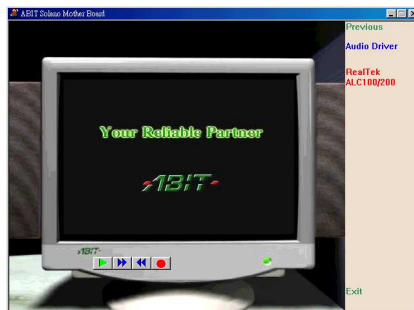

3. Move the cursor to “RealTek ALC100/200” and click on it to go on.

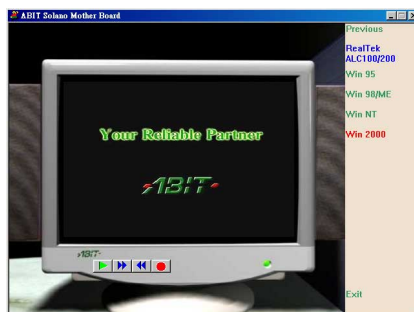

4. Move the cursor to “Win 2000” and click on it to go on.

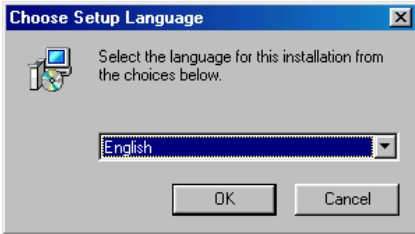

5. Choose the language for this installation.

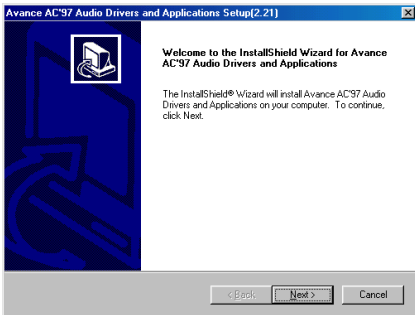

6. The Welcome screen appears. Click “Next” to go on.

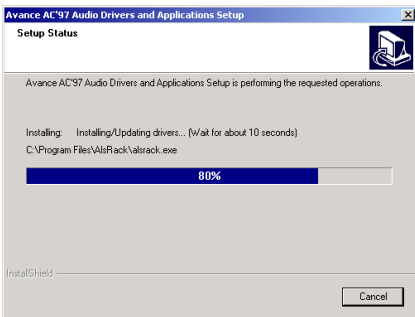

7. The install shield is now loading.

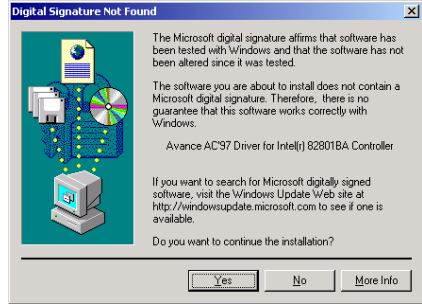

8. Click “Yes” to go on.

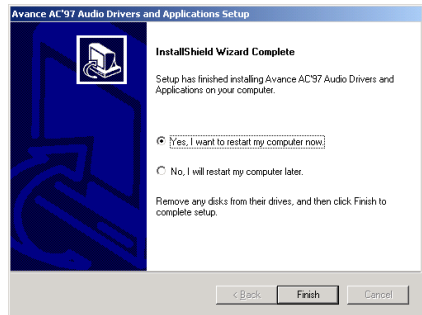

9. Choose “Yes, I want to restart my computer now”, and click “Finish” to end the installation.

Appendix H. Installing the ATA Utility for Windows® 2000

In this section we will show you how to install the ATA Utility to your Windows® 2000 operating system.

Insert the SA6/SA6R CD-Title into your CD-ROM drive, it should execute the program automatically. If not, you can go to the CD location and execute the execution file at the main directory of this CD-Title. After it has been executed you will see the screen below.

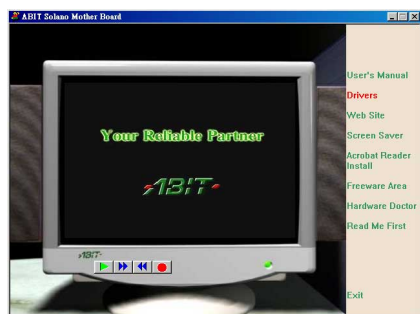

1. Move the cursor to “Drivers” and click on it to go on.



2. Move the cursor to “Intel Ultra ATA Storage Driver” and click on it to go on.

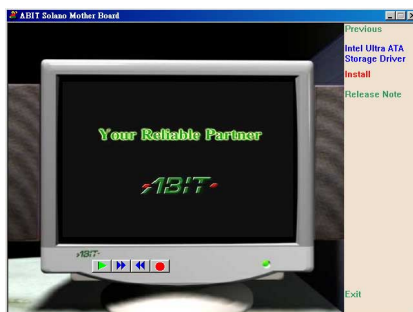

3. Move the cursor to “Install” and click on it to go on.

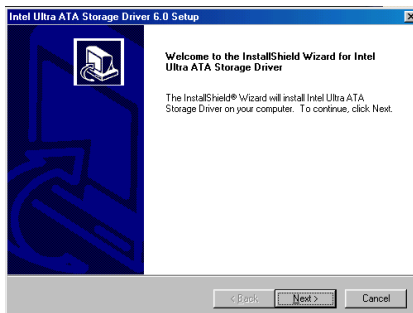

4. The Welcome screen appears. Click “Next>” to go on.

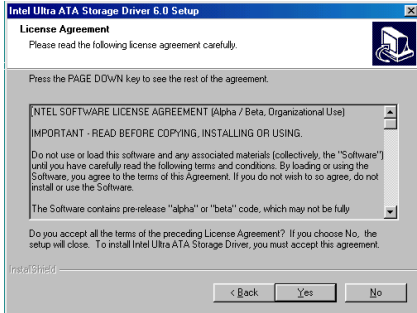

5. The License screen appears. Read it and click **“Yes”** to go on.

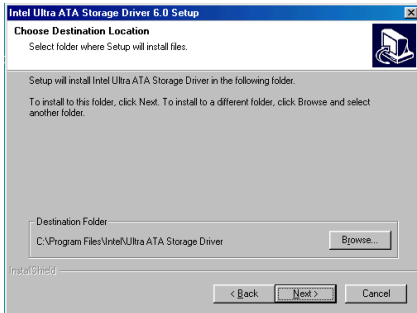

6. Now you can choose the folder for the destination location you want to install the driver. We suggest you use the default folder as the destination. When you have decided on the destination, click **“Next>”** to go on.

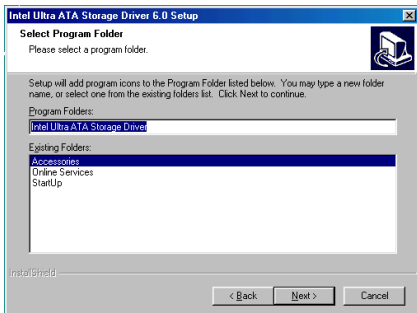

7. Now you can choose the program folder. Setup will add program icons to those program folders listed. Click **“Next>”** to go on.

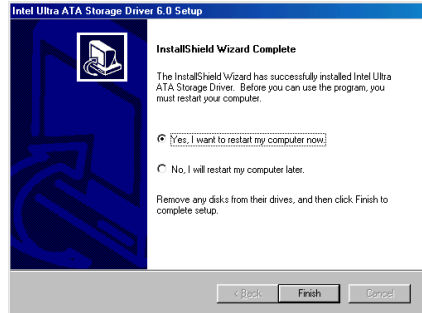

8. Choose **“Yes, I want to restart my computer now”**, and click **“Finish”** to end the installation.

Appendix I. BIOS Update Guide

We will use the SE6 as an example; all other models follow the same process.

1. First, know your motherboard's model name and version number. You can find it on one slot of the motherboard. Each motherboard always has the label at the same place as shown in the photo below.



You will find the model name and version on the white sticker.

2. Know the current BIOS ID.

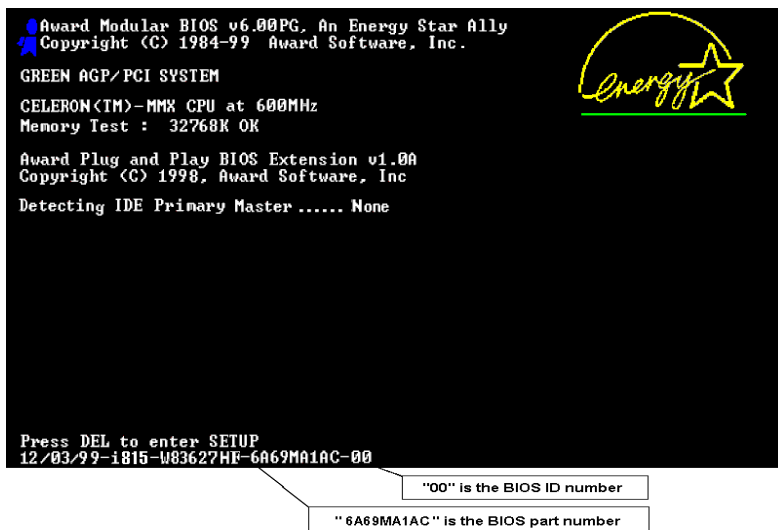

For example, in this case, the current BIOS ID is "00". If you already have the latest BIOS, no any update action is necessary. If your BIOS is not the latest BIOS, go on to the next step.

3. Download the correct BIOS file from our Web site.

[SE6]

Filename:

[SE6SW.EXE](#)

Date: 07/06/2000

ID: SW

NOTE:

1. Fixes SCSI HDD detection problem when booting from SCSI CD-ROM and executing FDISK.
2. Supports 512MB memory modules.
3. Sets the In-Order Queue Depth default to 4, increasing the integrated video performance.

Go to our Web site and choose the correct BIOS file and download it.

4. Double click the download file, it will self-extract to .bin file.

```
LHA's SFX 2.13S <c> Yoshi, 1991
$E6_SW.BIN .....
```

5. Make a bootable floppy disk and copy the necessary files onto it.

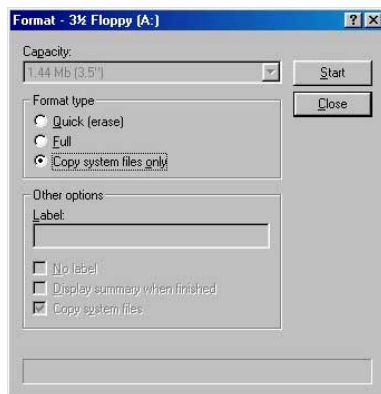

You may make a floppy disk bootable either in Explorer or in the DOS prompt mode.

```
[c:\]format a: /s
```

After formatting and transferring the system to the floppy disk, copy two files into it. One is the BIOS flash utility “**awdf flash.exe**” and the other is the decompressed BIOS binary file.

6. Boot off floppy disk.

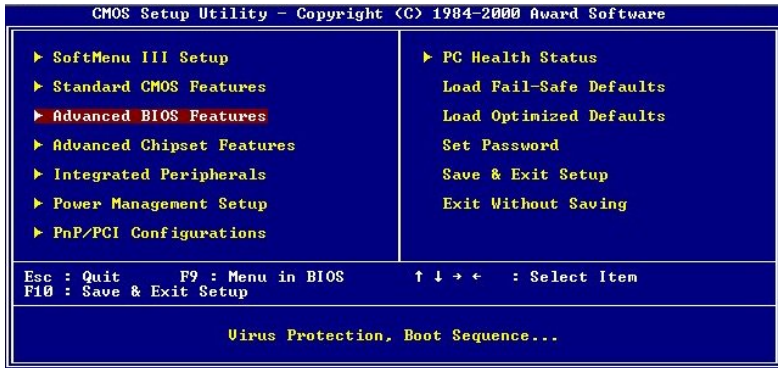

Please set the first boot sequence as “floppy” in BIOS and boot off the floppy disk.

7. Flash the BIOS in pure DOS mode.

```
A:\>awdflash se6_sw.bin /cc /cd /cp /py /sn /cks /r_
```

After successfully booting off of the floppy, execute the flash utility according to these instructions.

Note

We strongly recommend you use the above parameters following 'awdflash' to flash your BIOS. **DO NOT** just type "awdflash se6_sw.bin" without the above parameters following the ".bin" file.

Note

- The Award flash utility cannot be completed under the Windows® environment. It must be done in a pure DOS environment.
- You should check which BIOS file is to be used with your motherboard, don't flash with the wrong BIOS file. Otherwise, it may cause system malfunctions.

Note

Please do not use the Award flash memory writer version earlier than Version 7.52C to flash the BIOS. Otherwise, it may cause flash fail or un-anticipated problems.

Note

During the updating, the progress will be measured by white blocks. The last four *blue* blocks of the flash update process represent the "BIOS boot block". The BIOS boot block is used to prevent the BIOS from becoming corrupt during programming. It should not be programmed every time. If this "BIOS boot block" remains intact when the BIOS becomes corrupt during programming, then you can boot from a bootable floppy next time you boot your computer. This allows you to flash your BIOS again without the need for technical support from the dealer.

Appendix J. Hardware Monitoring Function (Installing the Winbond Hardware Doctor Utility)

Winbond Hardware Doctor is a self-diagnostic system for PCs and must be used with the Winbond chipset: W83627HF IC series products. It protects PC hardware by monitoring several critical items including power supply voltages, CPU & system fan speeds and CPU and system temperatures. These items are important for the operation of the system. Errors may result in permanent damage to the PC. Once any item is out of its normal range, a warning message will pop up and remind the user to take the proper measures.

The following description will tell you how to install and use the Hardware Doctor. You should have the Winbond Hardware Doctor utility on a CD-ROM or floppy diskette. If you have a floppy diskette, just insert diskette 1 and execute the **Setup.exe** file to start installation. Setup is required only for Windows 9X/ME.

Insert the SA6/SA6R CD-Title into your CD-ROM drive, it should execute the program automatically. If not, you can go to the CD location and execute the execution file at the main directory of this CD-Title. After it has been executed you will see the screen below.

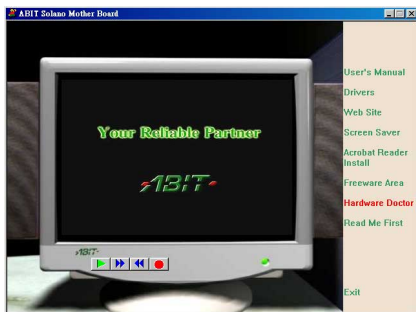

1. Move the cursor to “**Hardware Doctor**” and click on it to go on.





2. Move the cursor to “**HWDOCTOR For Win 9X/ME**” and click on it to go on.

The *HWDoctor Setup* screen will show up. Please refer the to figure below.

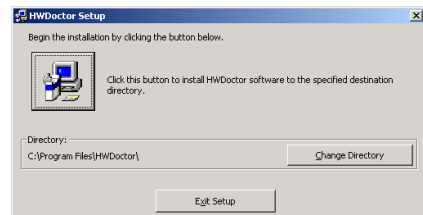

3. Click the “**OK**” button and the screen below will appear.



4. You can specify the program install path by clicking the “**Change Directory**” button. Or if you want to use the default path, click the  icon to continue the install process.

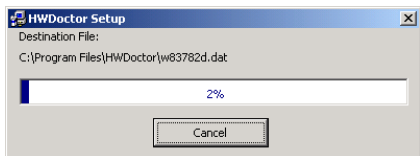

5. Now the screen will show you the percentage of installation progress.

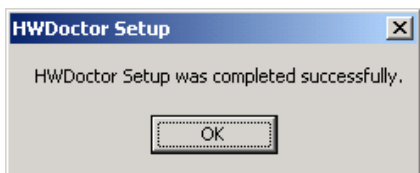

6. When the process is finished, click the "OK" button.

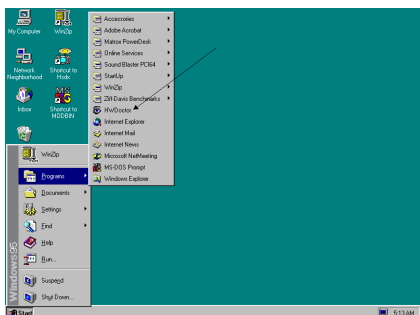

7. Go to the Windows toolbar and click the "Start" button. Then choose the "Program" → "HWDoctor" (See the arrow mark).

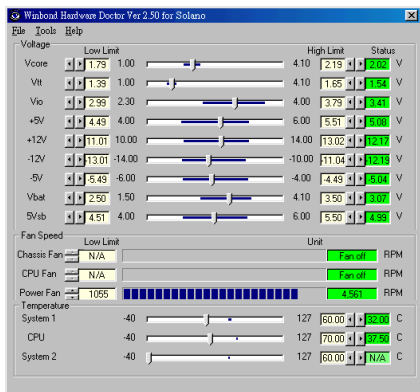

8. This screen will appear. You will see voltages, fan speeds and temperature readings as well. If any item readings are critical or over their limitations, the reading will turn red. Also, a pop-up window will appear to warn you the system has a problem!

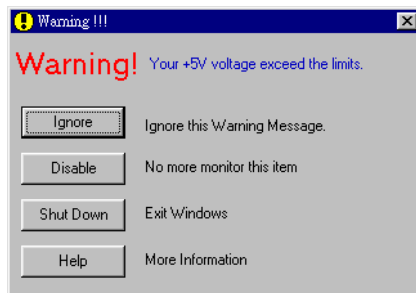

9. This is the warning message window:

Ignore: You can ignore the warning message of the item, but it will pop up again when an error of the same item reoccurs.

Disable: The chosen item will be no longer monitored thereafter, unless you activate it in the "Configuration" page.

Shutdown: Choosing this button will shutdown the computer.

Help: You can read more information and self-diagnose simple problems.

If the warning message pops up due to the wrong warning limit, you can adjust it in the "Configuration" option. For example, if you set the temperature high limit to 40°C, you will easily exceed the "proper" temperature.

Please pay attention to two things when you want to make any changes to the "Configuration" option. Firstly, you have to make sure your new setting is in the proper range. Secondly, after you finished the configuration, you have to save it. Otherwise, the program will start with the default value the next time.

If you encounter any problems or have any questions about the software settings and adjustments, please use the Winbond hardware doctor on-line help. It should give you enough information to answer your questions.

Appendix K. Installation Guide for Suspend to RAM

Suspend To RAM (STR) is a cost-effective, optimal implementation of the ACPI 1.0 specification. The ACPI specification defines the S3 sleep state, in which all system context is lost except system memory. CPU, cache, and chip set context are lost in this state. Hardware maintains memory context and restores some CPU and L2 configuration context.

The STR function enables a PC to achieve the S3 state during idle periods, then quick “wake up” and retrieve the last “state” of the system before it went to sleep. When idle, STR-enabled systems consume only a small fraction of the power used for full operation. Instead of shutting down the system to save power when not in use and then having to reboot later, users can let the STR function take over and not have to worry about using power to run all the electronics, fans and disks. When needed, a PC with STR function can restore all applications and features to an operational state within a few seconds.

The following description will tell you how to install the STR function and use it.

Note

To get Windows® 98 to enable the ACPI BIOS function, you have to type the parameter after the setup command, for example, setup /p j. This command will let Windows® 98 automatically install the necessary elements for the ACPI BIOS. If you have already installed Windows® 98 without using this command, you have to re-install Windows® 98 and use the /p j command. Otherwise, your Windows® 98 ACPI function may not work.

As above note mentioned, you have to use the parameter come with the setup command to install your Windows® 98. After you complete Windows® 98 installation and reboot your computer, you can see these items show up in the *System Properties* → *Device Manager*:

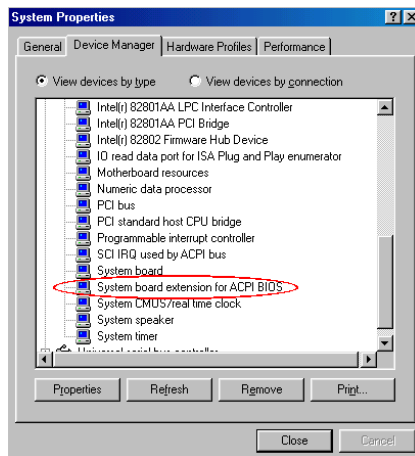
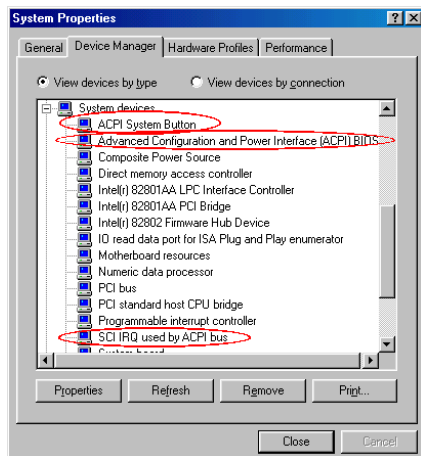

- ♦ ACPI System Button
- ♦ Advance Configuration and Power Interface (ACPI) BIOS
- ♦ PCI IRQ use by ACPI bus
- ♦ System board extension for ACPI BIOS

After these items show up, you can go to the next step for the STR function setting.

How to use the STR function:

There are two ways to put your system into STR mode:

Method 1: Select “Stand by” in the “Shut Down Windows” area.

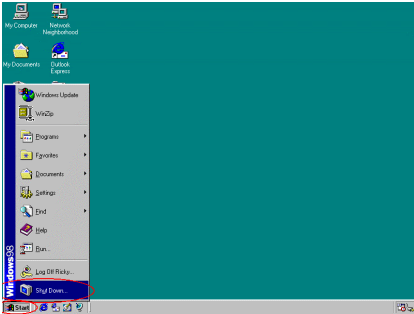

1. Click “Start” in the Windows Tools Bar, and then select “Shut Down...”



2. Select “Stand by”, and then click “OK”.

Method 2: Define the case “Power” button to initiate STR sleep Mode

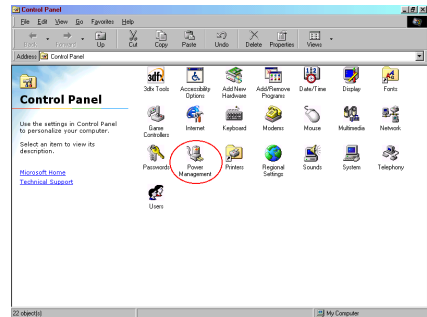

1. Open “Control Panel”, and then enter “Power Management”.

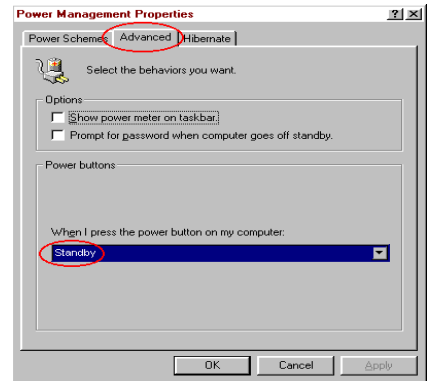

2. Select “Advanced”, and then set the “Power Buttons” to “Standby”.

Restart your computer to put these settings into effect. Now you will only need to press the “Power” button on the front panel of the chassis when you want to put your computer into STR sleep mode.

Appendix L. Troubleshooting (Need Assistance?)

If you have a problem during operation and in order to help our technical support personnel to quickly find out what the problem of your motherboard is and to give you the answers you need, before filling in the technical support form, eliminate any peripheral that is not related to the problem, and indicate on the form, the system's peripherals. Fax this form to your dealer or to the company where you bought the hardware or your nearest ABIT branch office in order to benefit from our technical support. (You can refer to the examples given below)

Example 1: With a system including: motherboard (with CPU, DRAM, COAST...) HDD, CD-ROM, FDD, MPEG CARD, SCSI CARD, SOUND CARD, etc. After the system is assembled, if you cannot boot up, check the key components of the system using the procedure described below. First remove all interface cards and try to reboot.

☛ If you still cannot boot up:

If it still does not start, note the motherboard model, BIOS identification number, CPU on the technical support form (refer to main instructions), and describe the problem in the problem description space provided.

☛ If you can boot up:

Reinsert the interface cards you have removed one by one and try to start the system each time you insert a card, until the system doesn't start anymore. Keep the interface card that causes the problem inserted on the motherboard, remove any other card or peripheral, and start again. If you still cannot start, note down the information related to both cards in the add-on Card space provided, and don't forget to indicate the motherboard model, version, BIOS identification number, CPU (refer to main instructions), and give a description of the problem.

Example 2: With a system including the motherboard (with CPU, DRAM, COAST...) HDD, CD-ROM, FDD, LAN CARD, MPEG CARD, SCSI CARD, SOUND CARD, after assembly and after having installed the Sound Card Driver, when you restart the system, when it runs the Sound Card Driver, it resets automatically. This problem may be due to the Sound Card Driver. During the Starting DOS... procedure, press SHIFT (BY-PASS) key, to skip CONFIG.SYS and AUTOEXEC.BAT; edit CONFIG.SYS with a text editor, and in function the line that loads the Sound Card Driver, add a remark REM, in order to disable the Sound Card Driver. See the example below.

```
CONFIG.SYS:
DEVICE=C:\DOS\HIMEM.SYS
DEVICE=C:\DOS\EMM386.EXE HIGHSCAN
DOS=HIGH, UMB
FILES=40
BUFFERS=36
REM DEVICEHIGH=C:\PLUGPLAY\DWCFGMG.SYS
LASTDRIVE=Z
```

Restart the system. If the system starts and does not reset, you can be sure that the problem is due to the Sound Card Driver. Note down the Sound Card model, motherboard model, BIOS identification number on the technical support file (refer to main instructions), and describe the problem in the space provided.



Main instructions...

To fill in this “**Technical Support Form**”, refer to the step-by-step instructions given below:

- 1*. **MODEL:** Note the model number given in your user’s manual.
Example: WX6e, BX6, BH6, etc...
- 2*. **Motherboard model number (REV):** Note the motherboard model number labeled on the motherboard as “REV:*.**”.
Example: REV: 1.01
- 3*. **BIOS ID and Part Number:** See next page example.

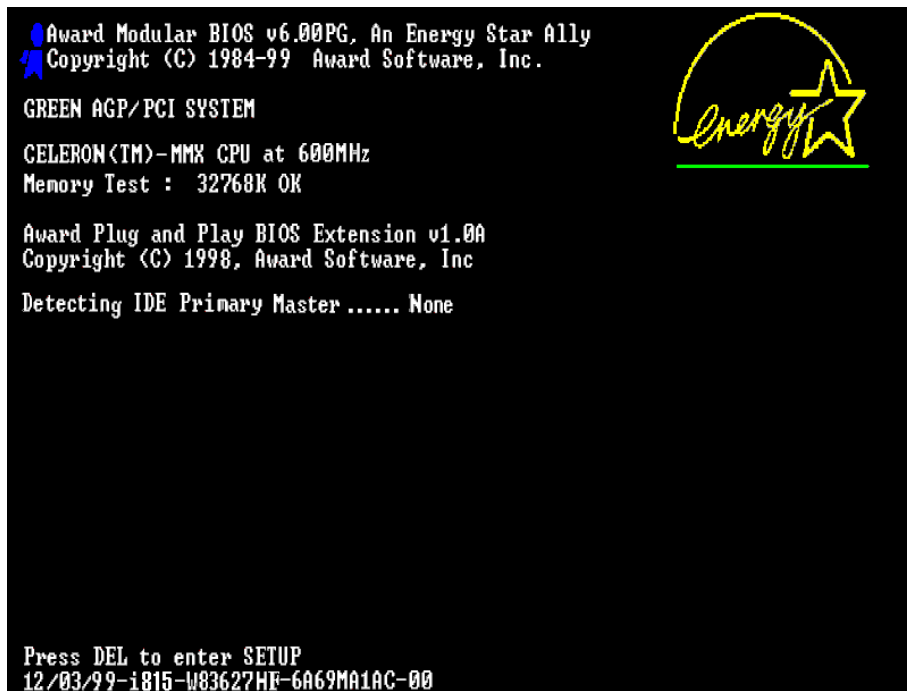

"00" is the BIOS ID number

"6A69MA1AC" is the BIOS part number

4. **DRIVER REV:** Note the driver version number indicated on the DEVICE DRIVER disk (if have) as “Release *.*”. For example:

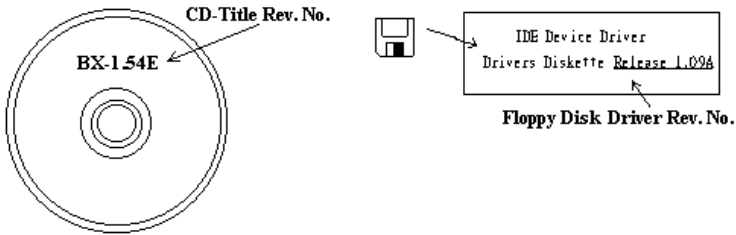

- 5*. **OS/APPLICATION:** Indicate the operating system and applications your are running on the system.

Example: MS-DOS® 6.22, Windows® 95, Windows® NT....

- 6*. **CPU:** Indicate the brand and the speed (MHz) of your CPU.

Example:(A) In the “Brand” space, write “Intel”, in the “Specifications” space, write “ Pentium® II MMX 300MHz” .

7. **HDD:** Indicate the brand and specifications of your HDD(s), specify if the HDD is using IDE1 or IDE2. If you know the disk capacity, indicate it and check (“✓”)“”; in case you give no indication, we will consider that your HDD is “IDE1” Master.

Example: In the “HDD” space, check the box, in the Brand space, write “Seagate”, in the Specifications space, write “ST31621A (1.6GB)”.

8. **CD-ROM Drive:** Indicate the brand and specifications of your CD-ROM drive. Specify if it uses IDE1 or IDE2 . and check (“✓”)“”; in case you give no indication, we will consider that your CD-ROM is “IDE2” Master.

Example: In the “CD-ROM drive” space, check the box, in the Brand space, write “Mitsumi”, in the Specifications space, write “FX-400D”.

9. **System Memory (DRAM):** Indicate the brand and specifications (SIMM / DIMM) of your system memory. For example:

In the Brand space, write “Panasonic”, in the Specifications space, write “SIMM-FP DRAM 4MB-06”.

Or, in the Brand, write “NPNX”, in the Specifications space, write “SIMM-EDO DRAM 8MB-06”.

Or, in the Brand space, write “SEC”, in the Specifications space, write “DIMM-S DRAM 8MB-G12”.

10. **ADD-ON CARD:** Indicate which add-on cards you are *absolutely sure* are related to the problem.

If you cannot identify the problem’s origin, indicate all the add-on cards inserted into your system.

Note

Items between the “*” are absolutely necessary.

Appendix M. How to Get Technical Support

(From our website) <http://www.abit.com.tw>

(In North America) <http://www.abit-usa.com>

(In Europe) <http://www.abit.nl>

Thank you for choosing ABIT products. ABIT sells all our products through distributors, resellers and system integrators, we have no direct sales to end-users. Before sending email for tech support please check with your resellers or integrators if you need any services, they are the ones who sold you your system and they should know best as to what can be done, how they serve you is a good reference for future purchases.

We appreciate every customer and would like to provide the best service to you. Providing fast service to our customers is our top priority. However we receive many phone calls and a huge amount of email from all over the world. At the present time it is impossible for us to respond to every single inquiry. Therefore it is quite possible that if you send an email to us that you may not receive a response.

We have done many compatibility tests and reliability tests to make sure our products have the best quality and compatibility. In case you need service or technical support, please understand the constraint we have and **always check with the reseller who sold the product to you first.**

To expedite service, we recommend that you follow the procedures outlined below before contacting us. With your help, we can meet our commitment to provide the best service to the **greatest number of ABIT customers:**

- 1. Check the Manual.** It sounds simple but we have taken a lot of care in making a well-written and thorough manual. It is full of information that doesn't only pertain to motherboards. The CD-ROM included with your board will have the manual as well as drivers. If you don't have either one go to our Program Download Area of the Website or FTP server at:
<http://www.abit.com.tw/download/index.htm>
 - 2. Download latest BIOS, software or drivers.** Please go to our Program Download area on our Website to check to see if you have the latest BIOS. They are developed over periods of time to fix bugs or incompatibilities. **Also please make sure you have the latest drivers from your peripheral cards makers!**
 - 3. Check the ABIT Technical Terms Guide and FAQ on our Website.** We are trying to expand and make the FAQs more helpful and information rich. Let us know if you have any suggestions. For hot topics check out our HOT FAQ!
-

- 4. Internet Newsgroups.** They are a great source of information and many people there can offer help. ABIT's Internet News group, alt.comp.periphs.mainboard.abit, is an ideal forum for the public to exchange information and discuss experiences they have had with ABIT products. Many times you will see that your question has already been asked before. This is a public Internet news group and it is reserved for free discussions. Here is a list of some of the more popular ones:

alt.comp.periphs.mainboard.abit

comp.sys.ibm.pc.hardware.chips

alt.comp.hardware.overclocking

alt.comp.hardware.homebuilt

alt.comp.hardware.pc-homebuilt

- 5. Ask your reseller.** Your ABIT authorized distributor should be able to provide the fastest solution to your technical problem. We sell our products through distributors who sell to resellers and stores. Your reseller should be very familiar with your system configuration and should be able to solve your problem much more efficiently than we could. After all, your reseller regards you as an important customer who may purchase more products and who can urge your friends to buy from him or her as well. They integrated and sold the system to you. They should know best what your system configuration is and your problem. They should have reasonable return or refund policies. How they serve you is also a good reference for your next purchase.
- 6. Contacting ABIT.** If you feel that you need to contact ABIT directly you can send email to the ABIT technical support department. First, please contact the support team for the branch office closest to you. They will be more familiar with local conditions and problems and will have better insight as to which resellers offer what products and services. Due to the huge number of emails coming in every day and other reasons, such as the time required for problem reproduction, we will not be able to reply to every email. Please understand that we are selling through distribution channels and don't have the resources to serve every end-user. However, we will try to do our best to help every customer. Please also remember that for many of our technical support team English is a second language, you will have a better chance of getting a helpful answer if your question can be understood in the first place. Be sure to use very, simple, concise language that clearly states the problem, avoid rambling or flowery language and always list your system components. Here is the contact information for our branch offices:

In North America and South America please contact:

ABIT Computer (USA) Corporation

46808 Lakeview Blvd.
Fremont, California 94538, U.S.A.

sales@abit-usa.com

technical@abit-usa.com

Tel: 1-510-623-0500

Fax: 1-510-623-1092

In the UK and Ireland:

ABIT Computer Corporation Ltd.

Unit 3, 24-26 Boulton Road
Stevenage, Herts
SG1 4QX, UK

abituksales@compuserve.com

abitektech@compuserve.com

Tel: 44-1438-228888

Fax: 44-1438-226333

In Germany and Benelux (Belgium, Netherlands, Luxembourg) countries:

AMOR Computer B.V. (ABIT's European Office)

Van Coehoornstraat 7,
5916 PH Venlo, The Netherlands

sales@abit.nl

technical@abit.nl

Tel: 31-77-3204428

Fax: 31-77-3204420

All other territories not covered above please contact:

Taiwan Head Office

When contacting our headquarters please note we are located in Taiwan and we are 8+ GMT time. In addition, we have holidays that may be different from those in your country.

ABIT Computer Corporation

3F-7, No. 79, Sec. 1, Hsin Tai Wu Rd.
Hsi Chi, Taipei Hsien, Taiwan

sales@abit.com.tw

market@abit.com.tw

technical@abit.com.tw

Tel: 886-2-2698-1888

Fax: 886-2-2698-1811

7. **RMA Service.** If your system has been working but it just stopped, but you have not installed any new software or hardware recently, it is likely that you have a defective component. Please contact the reseller from whom you bought the product. You should be able to get RMA service there.
8. **Reporting Compatibility Problems to ABIT.** Because of tremendous number of email messages we receive every day, we are forced to give greater weight to certain types of messages than to others. For this reason, any compatibility problem that is reported to us, giving detailed system configuration information and error symptoms will receive the highest priority. For the other questions, we regret that we may not be able to reply directly. But your questions may be posted to the Internet news group in order that a larger number of users can have the benefit of the information. Please check the news group from time to time.
9. Listed below are some **chipset vendors' WEB site addresses** for your reference:
ALI's WEB site: <http://www.ali.com.tw/>
Highpoint Technology Inc.'s WEB site: <http://www.highpoint-tech.com/>
Intel's WEB site: <http://www.intel.com/>
SiS' WEB site: <http://www.sis.com.tw/>
VIA's WEB site: <http://www.via.com.tw/>

Thank you, ABIT Computer Corporation

<http://www.abit.com.tw>