Copyright and Warranty Notice

The information in this document is subject to change without notice and does not represent a commitment on part of the vendor, who assumes no liability or responsibility for any errors that may appear in this manual.

No warranty or representation, either expressed or implied, is made with respect to the quality, accuracy or fitness for any particular part of this document. In no event shall the manufacturer be liable for direct, indirect, special, incidental or consequential damages arising from any defect or error in this manual or product.

Product names appearing in this manual are for identification purpose only and trademarks and product names or brand names appearing in this document are property of their respective owners.

This document contains materials protected under International Copyright Laws. All rights reserved. No part of this manual may be reproduced, transmitted or transcribed without the expressed written permission of the manufacturer and authors of this manual.

If you do not properly set the Graphics Accelerator settings causing the motherboard to malfunction or fail, we cannot guarantee any responsibility.



SILURO MX200/MX400/T200/T400

Graphics Accelerator

Index

CHAPTER 1. INTRODUCTION.....	1-1
1-1. FEATURES.....	1-1
1-2. AVAILABLE MODELS.....	1-1
1-3. SPECIFICATIONS.....	1-2
SILURO MX200:.....	1-2
SILURO T200:.....	1-3
SILURO MX400:.....	1-4
SILURO T400:.....	1-5
1-4. FEATURES AND BENEFITS.....	1-6
1-5. DISPLAY MODES TABLE.....	1-8
CHAPTER 2. HARDWARE SETUP.....	2-1
2-1. CARD INSTALLATION.....	2-1
New Systems:.....	2-1
Systems with Existing VGA Card:.....	2-1
2-2. VGA OUTPUT CONNECTION.....	2-2
2-3. VGA AND TV OUTPUT CONNECTION.....	2-3
CHAPTER 3. SOFTWARE SETUP.....	3-1
3-1. WINDOWS 98/ME.....	3-1
Auto Setup:.....	3-1
3-2. WINDOWS 2000.....	3-3
Plug and Play Setup:.....	3-3
Auto Setup:.....	3-5
CHAPTER 4. UTILITY SETUP.....	4-1
4-1. WINDOWS DISPLAY PROPERTIES.....	4-1
Settings.....	4-1
Extended Desktop Mode:.....	4-2
General.....	4-3
Adapter.....	4-4
Monitor.....	4-4
Performance.....	4-6

Color Management	4-6
GeForce2 MX	4-7
3D Antialiasing Settings:.....	4-7
Direct3D Settings:.....	4-8
More Direct3D:	4-9
OpenGL Settings:.....	4-10
Overlay Controls:	4-11
Video Mirror Controls:.....	4-12
Hardware Options:	4-13
Desktop Utilities:.....	4-14
NVIDIA Desktop Manager.....	4-15
Application Managemnet:	4-15
Hot Keys:	4-16
Global Settings:	4-16
Zoom:	4-17
TwinView.....	4-18
For Windows 98/ME:.....	4-18
For Windows 2000:	4-20
Device Settings	4-22
Device Selection:.....	4-22
TV Output:	4-23
Color Correction:.....	4-24
Screen Adjustment:	4-25
Display Timing:.....	4-25
4-2. WINDVD.....	4-26
4-3. DIRECTX	4-29
4-4. GRAPHIC MAX.....	4-30
4-5. 3DEEP COLOR.....	4-34
4-6. DISPLAY TRAY ICON.....	4-40
4-7. BIOS FLASHING UTILITY	4-42

APPENDIX A. HOW TO GET TECHNICAL SUPPORTA-1

Chapter 1. Introduction

1-1. Features

Thank you for purchasing ABIT SILURO MX200/MX400/T200/T400 series Graphics Card, the most advanced solution for graphics enthusiasts.

Powered by NVIDIA GeForce2 MX Graphics Processing Unit (GPU), the Built-in high-speed video memory with up to 2.7GB/Sec (MX400/T400) bandwidth, and the TwinView Architecture, the ABIT SILURO MX200/MX400/T200/T400 Graphics Cards deliver the most visually compelling and complete graphics experience available today.

Combined with other innovations such as WinDVD, Graphic Max, 3Deep Color, the SILURO MX200/MX400/T200/T400 caters for all your graphics needs, plus an optional TV-Out capability, enables a wide range of applications, from 3D games to HDTV, DVD, digital creation, editing, and Internet browsing.

With this ABIT SILURO MX200/MX400/T200/T400 Graphics Card, you will not only see but also experience dynamic and realistic 3D worlds.

1-2. Available Models

SILURO MX200:

32MB Frame Buffer + VGA

SILURO T200:

32MB Frame Buffer + VGA + TV-Out

SILURO MX400:

64MB Frame Buffer + VGA

SILURO T400:

64MB Frame Buffer + VGA + TV-Out

1-3. Specifications

SILURO MX200:

NVIDIA GeForce2 MX200 2D and 3D Graphics Accelerator:

- Chipset: NVIDIA GeForce 2 MX200
- NVIDIA 256-bit Hi Performance 2D and 3D accelerator engine equipped
- AGP 2X/4X Support, AGP texturing, and Fast Writes Support.
- Integrated 350MHz RAMDAC, resolution up to 2048 x 1536 @75Hz
- Equipped 32MB SDRAM 64 bit bus Interface running at 166MHz.
- 175MHz core Clock, 350 million pixels/sec, 700 million texel/sec fill rate
- 1.3GB/sec memory bandwidth
- Second generation transform and lighting (T&L) engines
- DirectX and S3 texture compression
- 32-bit Z/stencil buffer
- Complete support for DirectX 7.0 and DirectX 6.0, DirectX 5.0

High Quality DVD Playback:

- High-Definition Video Professor (HDTV) for Full-screen Video playback of 720p and DVD resolution.
- Advanced support for DirectDraw
- Hardware color space conversion (YUV 4:2:2 and 4:2:0)
- 5-tap horizontal by 3-tap vertical filtering
- 8:1 up scaling and downscaling
- Per-pixel color keying
- Multiple video windows with hardware color space conversion and filtering
- DVD sub-picture alpha blended composition

SILURO T200:**NVIDIA GeForce2 MX200 2D and 3D Graphics Accelerator:**

- Chipset: NVIDIA GeForce 2 MX200
- NVIDIA 256-bit Hi Performance 2D and 3D accelerator engine equipped
- AGP 2X/4X Support, AGP texturing, and Fast Writes Support.
- Integrated 350MHz RAMDAC, resolution up to 2048 x 1536 @75Hz
- Equipped 32MB SDRAM 64 bit bus Interface running at 166MHz.
- 175MHz core Clock, 350 million pixels/sec, 700 million texel/sec fill rate
- 1.3GB/sec memory bandwidth
- Second generation transform and lighting (T&L) engines
- DirectX and S3 texture compression
- 32-bit Z/stencil buffer
- Complete support for DirectX 7.0 and DirectX 6.0, DirectX 5.0

TV-Out:

- Digital video output by integrated NTSC/PAL encoders
- Complete S-VHS & Composite Video-Output Ports support

High Quality DVD Playback:

- High-Definition Video Professor (HDTV) for Full-screen Video playback of 720p and DVD resolution.
- Advanced support for DirectDraw
- Hardware color space conversion (YUV 4:2:2 and 4:2:0)
- 5-tap horizontal by 3-tap vertical filtering
- 8:1 up scaling and downscaling
- Per-pixel color keying
- Multiple video windows with hardware color space conversion and filtering
- DVD sub-picture alpha blended composition

SILURO MX400:**NVIDIA GeForce2 MX400 2D and 3D Graphics Accelerator:**

- Chipset: GeForce2 MX400
- NVIDIA 256-bit Hi Performance 2D and 3D accelerator engine equipped
- AGP 2X/4X Support, AGP texturing, and Fast Writes Support.
- Integrated 350MHz RAMDAC, resolution up to 2048 x 1536 @75Hz
- Equipped 64MB SDRAM 128 bit bus Interface running at 166MHz.
- 200MHz core clock, 400 million pixels/sec, 800 million texel/sec fill rate
- 2.7GB/sec memory bandwidth
- Second generation transform and lighting (T&L) engines
- DirectX, OpenGL Optimizations Support and S3 texture compression
- 32-bit Z/stencil buffer
- Complete support for DirectX 7.0 and DirectX 6.0, DirectX 5.0

High Quality DVD Playback:

- High-Definition Video Professor (HDTV) for Full-screen Video playback of 720p and DVD resolution.
- Advanced support for DirectDraw
- Hardware color space conversion (YUV 4:2:2 and 4:2:0)
- 5-tap horizontal by 3-tap vertical filtering
- 8:1 up scaling and downscaling
- Per-pixel color keying
- Multiple video windows with hardware color space conversion and filtering
- DVD sub-picture alpha blended composition
- Video acceleration for DirectShow, MPEG-1, MPEG-2

SILURO T400:**NVIDIA GeForce2 MX400 2D and 3D Graphics Accelerator:**

- Chipset: GeForce2 MX400
- NVIDIA 256-bit Hi Performance 2D and 3D accelerator engine equipped
- AGP 2X/4X Support, AGP texturing, and Fast Writes Support.
- Integrated 350MHz RAMDAC, resolution up to 2048 x 1536 @75Hz
- Equipped 64MB SDRAM 128 bit bus Interface running at 166MHz.
- 200MHz core clock, 400 million pixels/sec, 800 million texel/sec fill rate
- 2.7GB/sec memory bandwidth
- Second generation transform and lighting (T&L) engines
- DirectX, OpenGL Optimizations Support and S3 texture compression
- 32-bit Z/stencil buffer
- Complete support for DirectX 7.0 and DirectX 6.0, DirectX 5.0

TV-Out:

- Digital video output by integrated NTSC/PAL encoders
- Complete S-VHS & Composite Video-Output Ports support

High Quality DVD Playback:

- High-Definition Video Professor (HDTV) for Full-screen Video playback of 720p and DVD resolution.
- Advanced support for DirectDraw
- Hardware color space conversion (YUV 4:2:2 and 4:2:0)
- 5-tap horizontal by 3-tap vertical filtering
- 8:1 up scaling and downscaling
- Per-pixel color keying
- Multiple video windows with hardware color space conversion and filtering
- DVD sub-picture alpha blended composition
- Video acceleration for DirectShow, MPEG-1, MPEG-2

1-4. Features and Benefits

Single-Chip GPU (Graphics Processing Unit)

- On-chip integration of the entire 3D pipeline (transformation, lighting, setup and rendering) offers the lowest possible component and board design cost.

Integrated Transform and Lighting

- Delivers 2-4X the triangle rate for 2-4X more detailed 3D scenes. Frees up CPU bandwidth for physics and artificial intelligence (AI), which results in more realistic object behaviors and character animation.

Independent Pipelined QuadEngine™

- Separate engines for transformation, lighting, setup and rendering provide a very powerful, highly efficient architecture that delivers 25 million triangles per second. Allows applications to represent 3D characters and environments with the highest degree of complexity possible.

350MHz RAMDAC

- Delivers the clearest, sharpest, most solid image quality at 2048 x 1536 resolution at 60Hz.

High-Speed Memory Bandwidth

- Built-in 64/32 MB high-speed video memory with up to 2.7GB/Sec (MX400) and 1.3GB/Sec (MX200) bandwidth.

256-Bit 2D Rendering Engine

- Delivers the industry's fastest 2D performance for ultra-fast screen refresh at high resolutions and 32-bit color depths.

Microsoft® DirectX® and OpenGL® Optimizations and Support

- Delivers the best performance and guarantees compatibility with all current and future applications and games.

TwinView™ Architecture

- Doubles your desktop workspace using two space saving displays. You can extend one application across two displays or run separate applications on each screen.

Digital Vibrance Control™

- Provides crisp, bright visuals.

Second Generation Integrated Transform and Lighting (T&L) Engines

- Provides a more powerful and balanced PC platform by offloading graphics-intensive workload from the CPU.

NVIDIA Shading Rasterizer (NSR)

- Brings natural material properties to life with advanced per-pixel shading capabilities.

High-Definition Video Processor (HDVP)

- Turns your PC into a full-quality DVD player and HDTV receiver/player.

AGP 4X/2X, AGP Texturing, and Fast Writes Support

- Takes advantage of new methods of transferring information more efficiently, and allows content developers to use high-quality, 32-bit color textures and high-polygon-count scenes.

TV-Out

- Gives end users the option of big-screen gaming, digital time-shifting VCR, and video editing applications.

1-5. Display Modes Table

This display mode table is for your reference only. The display mode will differ depending on your specific monitor, and so the resulting display may not be identical to this table.

Resolution	Colors	Vertical Refresh Rate
640 x 480	8/16/32 bits	60Hz to 240Hz
800 x 600	8/16/32 bits	60Hz to 240Hz
1024 x 768	8/16 bits	60Hz to 240Hz
1024 x 768	32 bits	60Hz to 200Hz
1152 x 864	8/16 bits	60Hz to 200Hz
1152 x 864	32 bits	60Hz to 170Hz
1280 x 960	8/16 bits	60Hz to 170Hz
1280 x 960	32 bits	60Hz to 150Hz
1280 x 1024	8/16 bits	60Hz to 170Hz
1280 x 1024	32 bits	60Hz to 150Hz
1600 x 900	8/16 bits	60Hz to 150Hz
1600 x 900	32 bits	60Hz to 120Hz
1600 x 1200	8/16 bits	60Hz to 120Hz
1600 x 1200	32 bits	60Hz to 100Hz
1920 x 1080	8/16 bits	60Hz to 100Hz
1920 x 1080	32 bits	60Hz to 85Hz
1920 x 1200	8/16 bits	60Hz to 100Hz
1920 x 1200	32 bits	60Hz to 85Hz
1920 x 1440	8/16 bits	60Hz to 85Hz
1920 x 1440	32 bits	60Hz to 75Hz
2048 x 1536	8/16 bits	60Hz to 75Hz
2048 x 1536	32 bits	60Hz

Chapter 2. Hardware Setup

2-1. Card Installation

This graphics card can only be installed in a motherboard with AGP slot. Please handle this card with care and make sure to unplug the power supply of your system before installation.

New Systems:

1. Unplug all power cords of your computer.
 2. Remove computer chassis cover.
 3. Locate the AGP slot on your motherboard.
 4. Remove the metal bracket corresponding to the AGP slot. Keep the screw.
 5. Align this card to the AGP slot. Hold the card's edges and insert it into the slot without using excessive force or pressing any components on the card. Make sure it is firmly and completely fixed into the slot.
 6. Secure this card's mounting bracket to the back panel of computer chassis with the screw removed from the metal bracket.
 7. Replace the chassis cover.
 8. Connect PC monitor or other display devices to this card.
 9. You are now ready to install the software drivers and utilities.
-

Systems with Existing VGA Card:

1. Change the display driver to Standard VGA.
 2. Shut down your computer and unplug all power cords.
 3. Replace the existing VGA card with this new card.
 4. Restart your computer.
 5. Install the software drivers.
-
-

2-2. VGA Output Connection

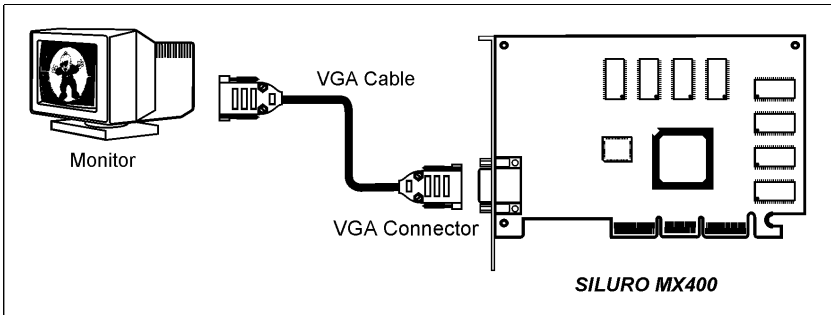
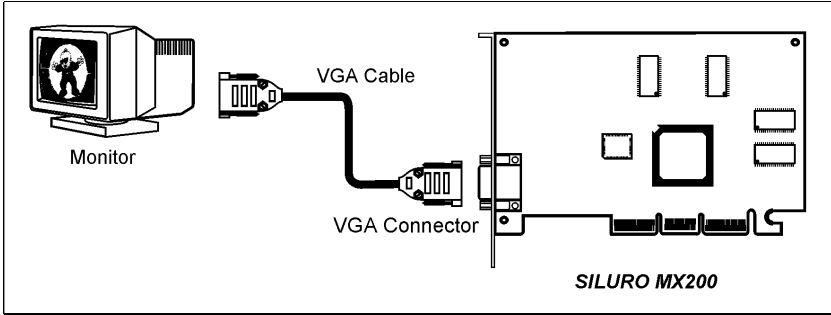

2-3. VGA and TV Output Connection

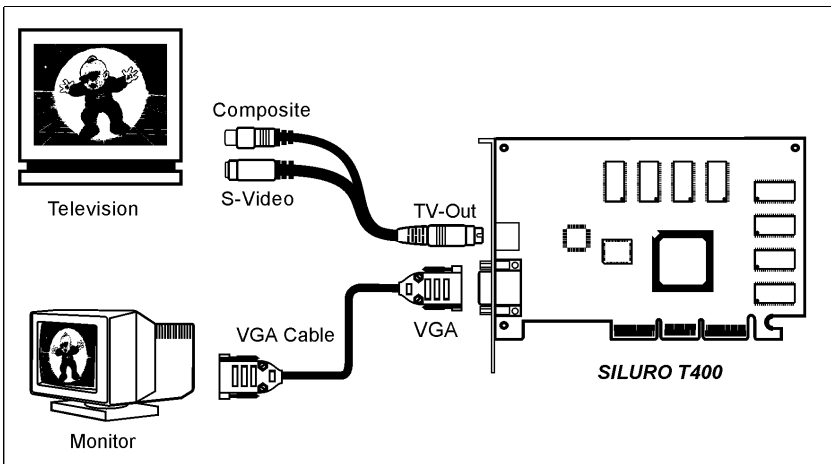
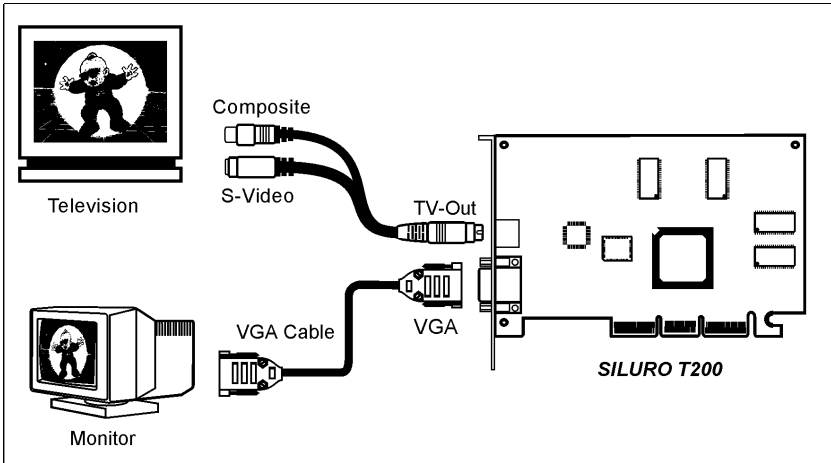



Chapter 3. Software Setup

The screen displays in this manual may not exactly reflect the screen shots on your screen. The contents of the Installation CD that came with this card are subject to change at any time without notice. The latest driver for this board is also downloadable from our WEB site at <http://www.abit.com.tw>.

3-1. Windows 98/ME

Auto Setup:

1. Start Windows. Insert the Installation CD into CD-ROM drive, it should execute the installation program automatically. If not, double-click the execution file at the main directory of this Installation CD to enter the installation menu.

Click “Driver Install”.

2. The welcome screen appears, click “Next>” to start installation.

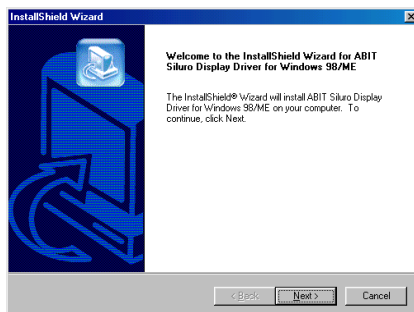

3. Click “**Y**es” if you want to install the DirectX, and then follow the on-screen instruction to complete the setup. Click “**N**o” if you don’t want to install the DirectX, and then restart the computer.

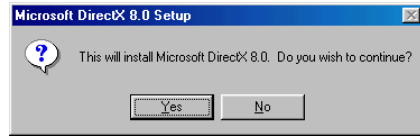

3-2. Windows 2000

Plug and Play Setup:

1. Start Windows. When Windows detects your graphics card, the Found New Hardware Wizard dialog box appears. Click “Next>”.
2. Select “Search for a suitable driver for my device [recommended]”, and then click “Next>”.
3. Select “Specify a location”, and then click “Next>”.

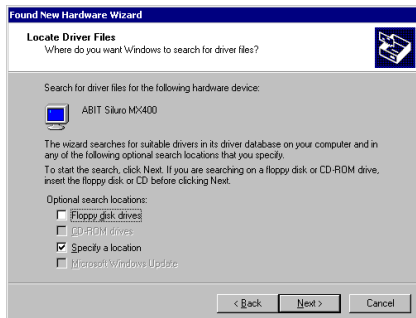

4. Insert the Installation CD into CD-ROM drive. Use the “Browse...” button to locate the driver, or type “D:\Driver\Win2K” to specify the path. D: is the CD-ROM drive. Click “OK” to continue.

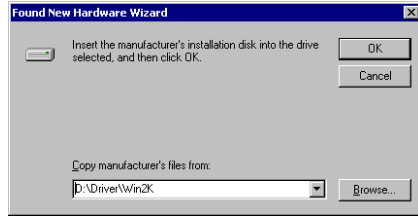

5. The wizard has found the driver for this device. Click “Next>” to continue.



6. Click “Yes” to continue.

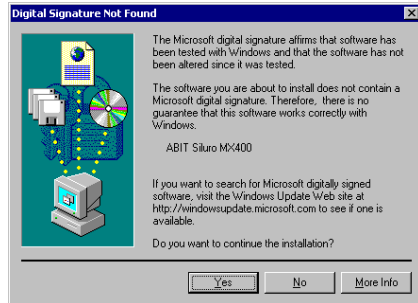

7. Windows has finished installing the software for this device. Click “Finish” to close the wizard.



Auto Setup:

1. Start Windows. Insert the Installation CD into CD-ROM drive, it should execute the installation program automatically. If not, double-click the execution file at the main directory of this Installation CD to enter the installation menu.

Click “Driver Install”.

2. The welcome screen appears, click “Next>” to start installation.

3. Click “Yes” to continue.

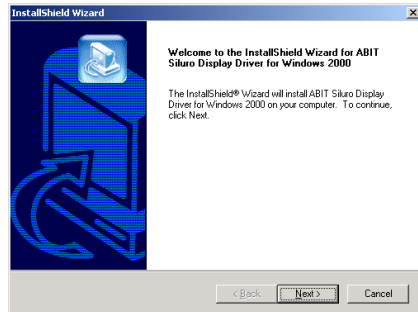

4. Click “**Y**es” if you want to install the DirectX, and then follow the on-screen instruction to complete the setup. Click “**N**o” if you don’t want to install the DirectX, and then restart the computer.

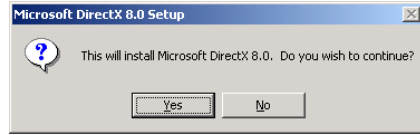

Chapter 4. Utility Setup

4-1. Windows Display Properties

The Windows Display Properties is a control panel that helps you to make adjustments on Adapter, Monitor, Performance, Color Management, Display Position, and TwinView functions.

To use the Windows Display Properties, right-click the ABIT Display Tray Icon on the taskbar's status area and then click Windows Display Properties to enter, or you may right-click the Windows 98/ME/2000 desktop, click "Properties" → "Settings" → "Advanced" to enter.

Settings

This tab displays icons that represent your monitors. If more than one icon is displayed, click each one to see the large number in the corresponding monitor. The settings for that monitor appear in Display, Colors, and Screen Area.

- **Display:** Displays all installed PCI and AGP video adapters. The adapter for your primary monitor is in position 1. To use an additional monitor, click its video adapter, and then click the *Extend my Windows desktop onto this monitor check box*.
- **Colors:** Displays the current color settings for the monitor whose video adapter appears in Display. To use a different color setting, click the arrow, and then click the setting you want.
- **Screen area:** Displays the current screen area settings for the monitor whose video adapter appears in Display. Drag the slider to specify the screen area you want. The higher the number of pixels, the more information you can display on your screen.
- **Extend my Windows desktop onto this monitor:** Selects the monitor whose video adapter appears in Display. This checkbox is available only for video adapters in position 2 and higher.

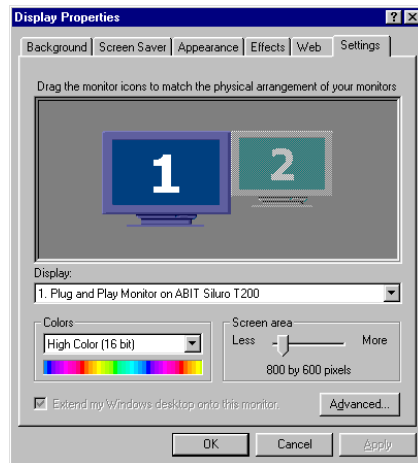

- **Advanced:** Click this button to open the Properties dialog box for the video adapter that appears in Display.

Extended Desktop Mode:

If more than one icon is displayed, drag them to the positions that represent how you want to move items between monitors. For example, if you are using two monitors and you want to move items from one monitor to the other by dragging left and right, position the icons side-by-side. To move items between monitors by dragging up and down, position the icons one above the other. The icon positions don't have to correspond to the physical positions of your monitors. That is, you can position the icons one above the other even though your monitors are side-by-side.

To initiate Extended Desktop Mode: Ensure the primary and secondary monitors are connected properly to the card. Click Monitor 2. A query screen pops up. Click "Yes", and then click "OK" in the Display Properties menu.

To position the secondary monitor: Click Monitor 2 and drag it over to any side of Monitor 1. The Windows object placed on the side of Monitor 1 near Monitor 2 now appears on Monitor 2. Right-clicking Monitor 2 will display its enabled status.

To disable Extended Desktop Mode: Deselect the check box of *Extend my Windows desktop onto this monitor*. Click "OK" and exit.

Note: Disabling Extended Desktop Mode is necessary before enabling any other mode, such as Clone Mode.

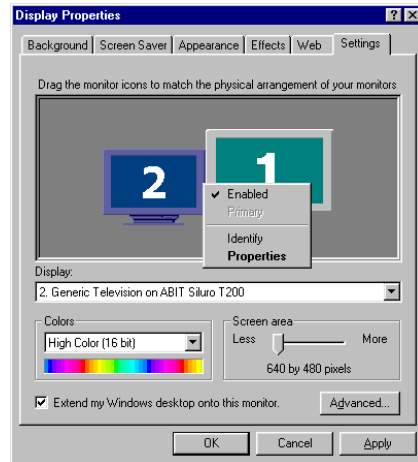
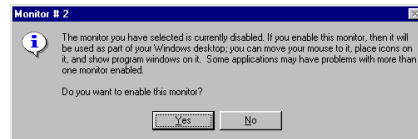
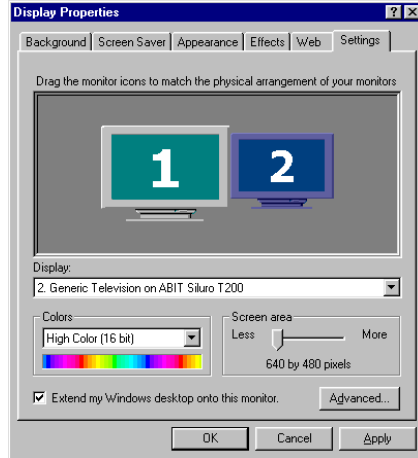

General

- **Font Size:** Displays the current font size for the selected monitor. To use a different font size, click the arrow, and then click the font size you want.
- **Restart the computer before applying the new color settings:** Specifies that you want your computer to restart automatically when you change system color settings.
- **Apply the new color settings without restarting:** Specifies that you want your computer to apply changes to system color settings without restarting. Some programs might not display colors correctly without being restarted after you make changes. To avoid this problem, close the program, change the color settings, and then open the program again.
- **Ask me before applying the new color settings:** Specifies whether Windows should display a prompt to restart every time you change system color settings.

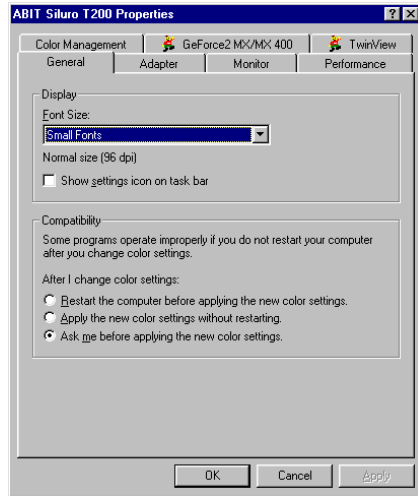

Adapter

This tab shows what type of display adapter you are currently using. To install the software for a new display adapter, click “Change”.

- **Change:** Click to install the software for a new display adapter.
- **Refresh rate:** Click this to change the refresh rate for your monitor.
The available choices depend on the kind of display adapter you have. This setting is initially set to the default rate for your adapter.

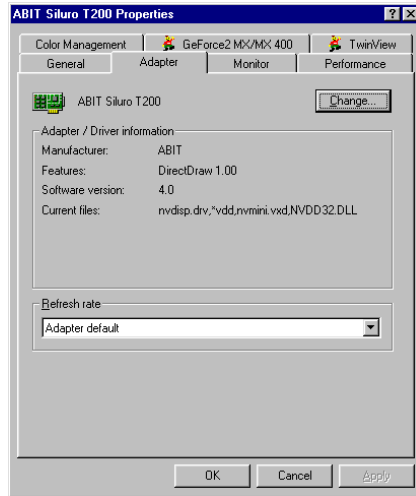

Monitor

- **Change:** Click to install the software for a new monitor.
- **Monitor is Energy Star compliant:** Indicates that your monitor can reduce its power usage. For Windows to take advantage of this feature, the monitor must adhere to the VESA Display Power Management Signaling (DPMS) specification or to another method of lowering power consumption (such as the LCD screens on portable computers). If your monitor has an Energy Star emblem, it probably supports DPMS.

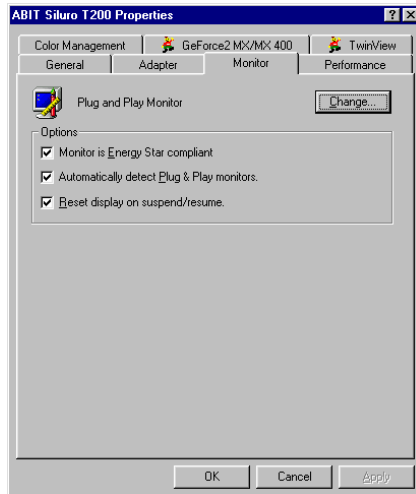

Energy Star is a program administered by the U.S. Environmental Protection Agency (EPA) to reduce the amount of power used by personal computers and peripherals. The Energy Star emblem does not represent EPA endorsement of any product or service.

If the information on your screen appears garbled or otherwise irregular when your power management screen saver appears, click to clear this check box.

- **Automatically detect Plug & Play monitors:** Specifies whether Windows should automatically detect whether your monitor is Plug and Play compatible and use the appropriate software for it.

Some display adapters cause the screen to flash while the monitor is being detected. If this happens, you may want to clear this check box.

- **Reset display on suspend/resume:** Specifies whether you want Windows to reset the display after you put your computer in Suspend mode and then resume activity.

Most display adapters cause the screen to flash while the monitor is being reset. You may be able to avoid the flashing by clicking to clear this check box. However, some adapters require the check box to be selected to work properly.

Performance

- **Hardware acceleration:** Specifies the degree of acceleration you want for your graphics hardware. Full acceleration is the fastest and is recommended for most computers. If your computer is having problems and you suspect graphics acceleration to be the cause, use the highest setting at which you do not have problems.

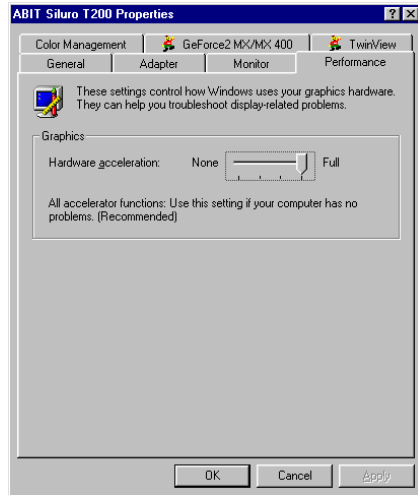

Color Management

This tab lists all the color profiles currently associated with this monitor. Click a profile to make it the active profile. Otherwise, the default profile is the active profile.

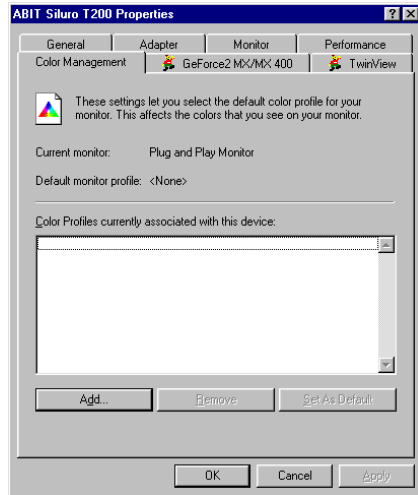

GeForce2 MX

- **Display Adapter Information:**
This information details the hardware aspects of the currently selected graphics adapter.
- **Driver Version Information:**
This table is a list of files and associated version information currently in use by your NVIDIA-based graphics adapter.
- **Additional Properties button:**
Click to access additional features of your NVIDIA-based graphics adapter.

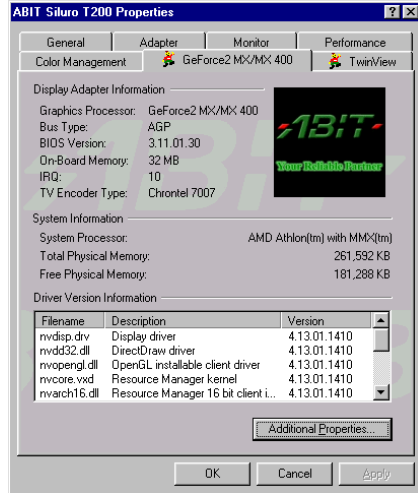

3D Antialiasing Settings:

- **Allow applications to control the antialiasing mode:** This option will automatically enable the optimal antialiasing settings for those 3D applications that support antialiasing.
- **Manually select the antialiasing mode:** This option will allow you to manually select the antialiasing mode to be used when running your 3D applications.

Off (no antialiasing): This option will disable antialiasing in 3D applications. Select this option if you require maximum performance in your applications.

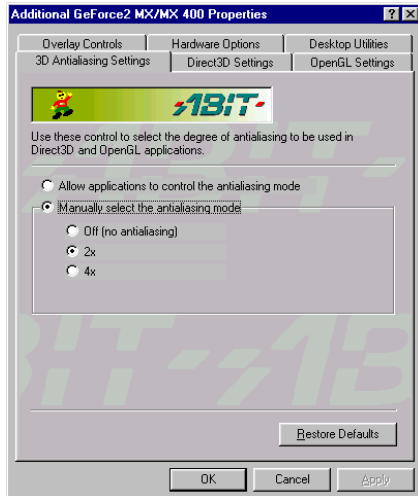

2x: This option will enable antialiasing using the 2x mode. It offers improved image quality and high performance in 3D applications.

4x: This option will enable antialiasing using the 4x mode. It offers the highest possible image quality at the expense of some performance in 3D applications.

Direct3D Settings:

- **Enable fog table emulation:** This option is used to turn fog table emulation on or off. Direct3D specifies that a display adapter capable of D3D hardware acceleration should be able to implement either vertex fog or table fog. Some games do not correctly query the D3D hardware capabilities and expect table fog support. Choosing this option will ensure that such games will run properly on your NVIDIA graphics processor.
- **Adjust Z-buffer depth to rendering depth if unequal:** Forces the hardware to automatically adjust the depth of its Z-buffer to the depth that the application requests. Normally, you will want to keep this option enabled, unless your work absolutely requires a specific Z-buffer depth. If this option is disabled, any application whose working Z-buffer depth does not match that of the current hardware configuration will not run.
- **Enable alternate depth buffering technique:** Enables an alternate technique for depth buffering. This lets the hardware use a different mechanism for depth buffering in 16 bit applications. Enabling this setting can produce higher quality rendering of 3D images.
- **Display logo when running Direct3D application:** Enables the NVIDIA logo in Direct3D. Enabling this setting will display the NVIDIA logo in the lower corner of the screen while running Direct3D applications.
- **Mipmap detail level:** Allows you to adjust the LOD (Level of Detail) bias for mipmaps. A lower bias will provide better image quality, while a higher bias will increase application performance. You can choose from five preset bias values, varying from “Best Image Quality” to “Best Performance”.

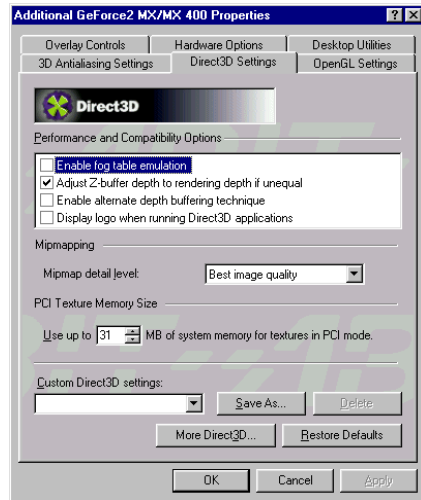

- **PCI Texture Memory Size:** This allows the graphics processor to utilize up to the specified amount of system memory for texture storage (in addition to the memory installed on the display adapter itself).

Note: The maximum amount of system memory that can be reserved for texture storage is calculated based on the amount of physical RAM installed in your computer. The more system RAM, the higher the value you will be able to set.

This setting applies only to PCI display adapters (or AGP display adapters running in PCI compatibility mode).

- **Custom Direct3D settings:** A list of the custom settings (or “tweaks”) you have saved. Selecting an item from the list will activate the setting. To apply the setting, choose the “OK” or “Apply” button.

More Direct3D:

- **Texel Alignment:** This option changes the hardware texture addressing scheme for texels (texture elements). Changing these values will adjust the texel origin definition. The default setting value is in accordance with Direct3D specifications. Some software will define the texture origin to other places. For such applications, re-defining the texture origin will improve the image quality. You can drag the slider to adjust the texel origin between the upper left corner to center of the texel.

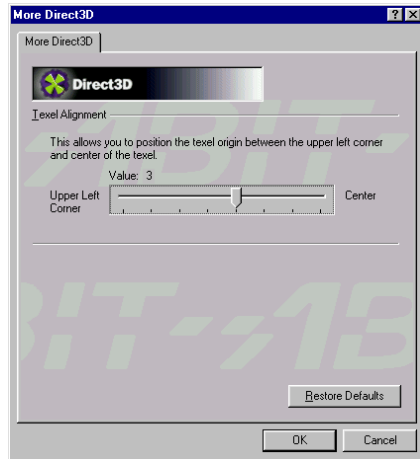

OpenGL Settings:

- **Enable buffer region extension:** Allows the drivers to use the OpenGL extension `GL_KTX_buffer_region`. This can increase application performance in 3D modeling applications that support this extension.
- **Allow the dual planes extension to use local video memory:** Allows the use of local video memory when the `GL_KTX_buffer_region` extension is enabled. However, if there are less than 8 MB of local video memory available, dual planes extension support will not be enabled. This setting has no effect if the “Enable buffer region extension” option above is disabled.
- **Use fast linear-mipmap-linear filtering:** Allowing fast linear-mipmap-linear filtering will provide increased application performance at the expense of some image quality. In many cases, a loss of image quality may not be noticeable, so you may wish to take advantage of the extra performance gained by enabling this feature.
- **Enable anisotropic filtering:** This option allows OpenGL to use anisotropic filtering for improved image quality.
- **Disable support for enhanced CPU instruction sets:** Select this option to disable driver support for enhanced instructions used by certain CPUs. Some CPUs support additional 3D instructions that complement your NVIDIA graphics processor and improve performance in 3D games or applications. This option allows you to disable support for these additional 3D instructions in the drivers. This can be useful for performance comparisons or for troubleshooting.
- **Default color depth for texture:** This option determines whether textures of a specific color depth should be used by default in OpenGL applications. **Use desktop color depth** will always use textures of the color depth at which your Windows desktop is currently running. **The Always use 16 bpp and Always use 32 bpp** options will force the use of textures of the specified color depth, regardless of your desktop settings.

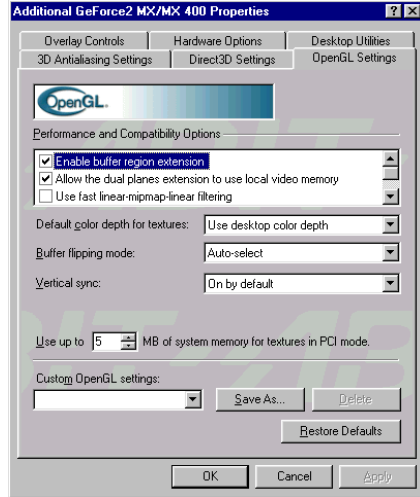

- **Buffer flipping mode:** This option determines the buffer flipping mode for full-screen OpenGL applications. You can select from the block transfer method, the page flip method or auto-select. Auto-select allows the driver to determine the best method based on your hardware configuration.
- **Vertical sync:** This option lets you specify how vertical sync is handled in OpenGL. **Always off** will always disable vertical sync in all OpenGL applications. **Off by default** will keep vertical sync disabled, unless an application specifically requests that it be enabled. **On by default** will keep vertical sync enabled, unless an application specifically requests that it be disabled.
- **Use up to “xx” MB of system memory for textures in PCI mode:** This allows the graphics processor to utilize up to the specified amount of system memory for texture storage (in addition to the memory installed on the display adapter itself). Note: The maximum amount of system memory that can be reserved for texture storage is calculated based on the amount of physical RAM installed in your computer. The more system RAM, the higher the value you will be able to set. This setting applies only to PCI display adapters (or AGP display adapters running in PCI compatibility mode).
- **Custom OpenGL settings:** A list of the custom settings (or “tweaks”) you have saved. Selecting an item from the list will activate the setting. To apply the setting, choose the “OK” or “Apply” button.

Overlay Controls:

- **Brightness, Contrast, Hue, Saturation:** Use these controls to adjust the quality of video or DVD playback on your monitor. You can independently control the brightness, contrast, hue and saturation to achieve optimal image quality when playing back videos or DVD movies on your computer.
- **Enable video overlay zoom:** This option enables the zoom controls to allow you to zoom in on a specific area of the video output screen.

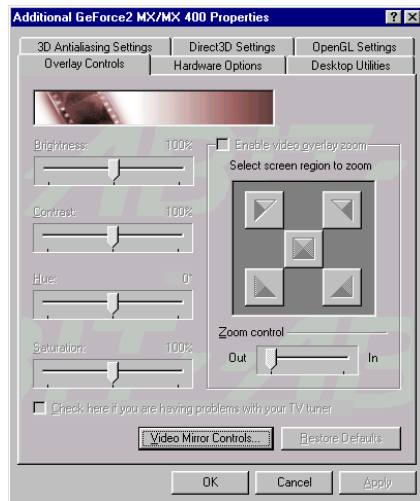

Note: (when enabling overlay zoom): Video players that are not able to detect the presence of Video Mirror may not update the zoom factor immediately while displaying a still frame.

- **Select screen region to zoom:** Lets you zoom in or out on the selected portion of the video playback screen.
- **Zoom control:** Lets you zoom in or out on the selected portion of the video playback screen.
- **Check here if you are having problems with your TV tuner:** Activating this option forces the overlay software to use busmastering. It is recommended that you leave this option unchecked unless you experience problems with video playback, such as image corruption or no video image at all.
- **Video Mirror Controls:** Clicking this button allows access to advanced video features provided by the TwinView Clone mode. Note that Clone mode must be currently enabled to access to these features.

Note: The Overlay Controls is only accessible when playing back video, such as AVI files or DVD movies, on your computer.

Video Mirror Controls:

Video Mirror is a TwinView feature that makes a video or DVD player to mirror playback in full-screen mode on any connected display devices. Video Mirror makes video data displayed on an overlay window on the primary display to project as a full-screen on the secondary display.

Note: Video Mirror is available both in Clone or Extended Desktop Mode.

- **Full Screen Device:** Selects the display device on which video is to be played back in full-screen mode.
- **Aspect Ratio:** Lets you select the aspect ratio (horizontal size to vertical size) of the full-screen playback.
- **Allow driver to select the full screen mode:** Activating this option allows the video driver to determine the optimal resolution for full-screen video playback.

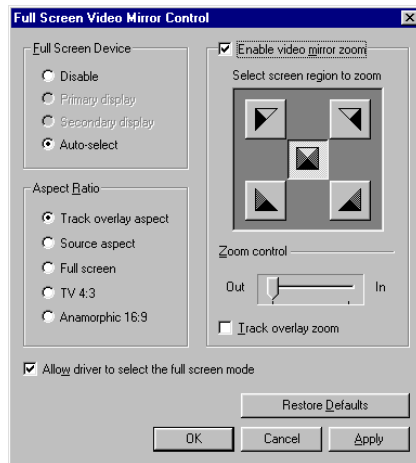

- **Enable video mirror zoom:** Enables the zoom controls to allow you to zoom in on a specific area of the video output screen.
- **Select screen region to zoom:** Here, you can select the area of the video screen you would like to zoom. Once selected, you can zoom to that portion of the screen by moving the slider control below.
- **Zoom control:** Lets you zoom in or out on the selected portion of the video playback screen.
- **Track overlay zoom:** Activating this option links the zoom control on the Overlay Controls page to simultaneously control the zoom factor on the full screen device as well.

Hardware Options:

This tab displays the information about the current AGP settings on your computer.

- **Manually select your AGP rate:** This option will allow you to manually select the AGP rate used by the graphics subsystem. If you are not sure which AGP rate to use, leave this checkbox unchecked. The system will then automatically determine the optimal AGP rate.
- **AGP Rate:** Move the slider control to manually select the AGP rate to be used by the graphics subsystem.

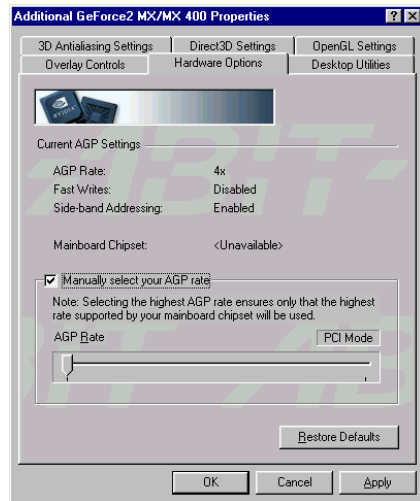

Desktop Utilities:

- Display the QuickTweak icon in the taskbar:** This option adds the QuickTweak icon to the Windows taskbar, allowing you to apply any of the custom Direct3D, OpenGL or color settings “on the fly” from a convenient popup menu. The menu also contains items for restoring default settings and accessing the Display Properties dialog.

Note: In TwinView Extended Desktop mode, an extra “Enable Desktop Manager” check box and “Desktop Manager Configuration” button appears on Desktop Utilities dialog.



- Enable Desktop Manager:** Allows you to choose the icon used to represent the QuickTweak utility in the Windows taskbar. Select the icon you want displayed from the list. Then choose “OK” or “Apply” to update the icon in the taskbar.
- Desktop Manager Configuration:** Opens the NVIDIA Desktop Manager configuration dialog. The Desktop Manager configuration dialog provides control of all Desktop Manager functions and settings, such as dialog re-centering options, hotkey selections, and application management settings.

NVIDIA Desktop Manager

In the TwinView Extended Desktop Mode, this Desktop Manager sets up the PC to run one or more programs on one or both monitors or desktops. Among others, it also allows you to undertake program-management features, such as restoring application windows to their last-used position.

Application Management:

This tab adds program applications to Desktop Manager. Click the “Add” button. The program applications currently open appear in the New Application box. Select the program you want to add, then click “OK”. The program appears in the Application Management window. Repeat this step for each program that you want to add to the Desktop Manager.

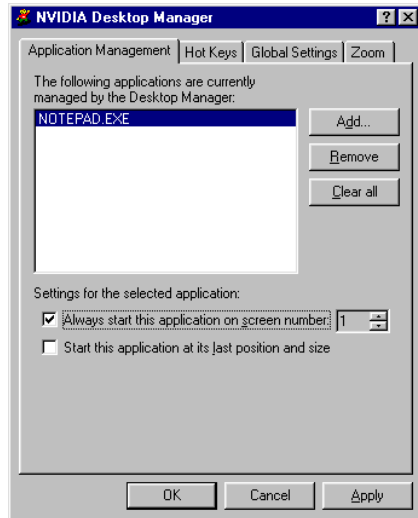
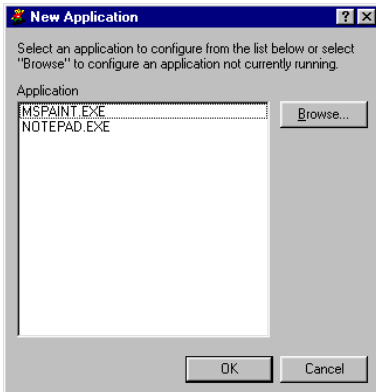
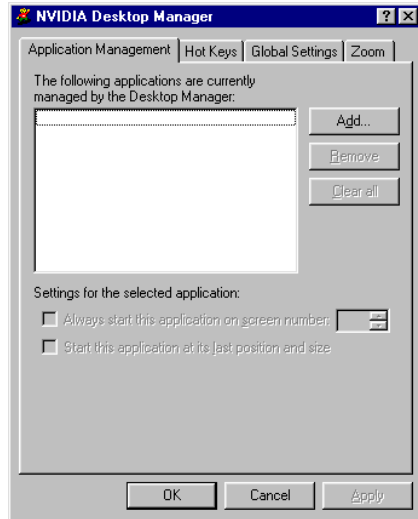

Hot Keys:

This tab allows you to set hot key for particular action by assigning the key combination you like.

The default key combinations for each actions are:

ALT + 1: Move the active window to another monitor.

ALT + 2: Move all windows to another monitor.

ALT + 3: Gather all windows to one monitor.

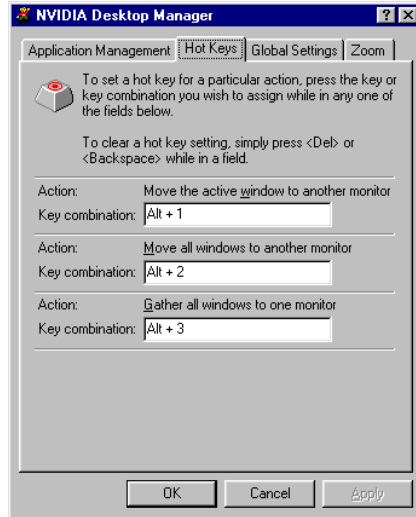

Global Settings:

This tab specifies settings that apply to all application running under Desktop Management.

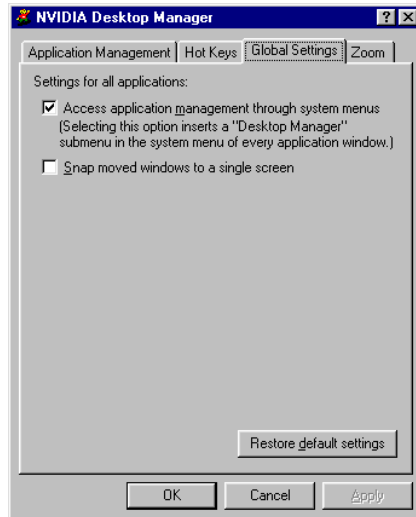

Zoom:

This tab enables a magnified portion of the screen under the mouse cursor (only available in TwinView horizontal and vertical spanning modes).

- **Enable zoom feature:** Turns on the zoom feature.
- **Hot keys to control zoom features:** Here you can specify hot key combinations to control zoom features.
- **Zoom update frequency (updates per second):** This setting updates the “refresh” frequency of the magnified portion in number of times per seconds.
- **Delay before switching zoom monitor (msec):** This setting controls the time delay in milliseconds before the magnified portion switches monitors when moving mouse cursor from one monitor to the other.

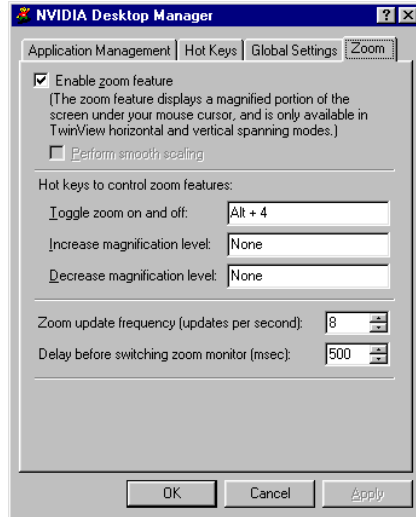

TwinView

This TwinView tab allows you to connect two separate output devices (analog monitor, digital flat panel or TV) to a single graphics card.

For Windows 98/ME:

- **TwinView Standard Mode (TwinView disabled):** Use this mode if you have only one display device attached to your ABIT graphics adapter.

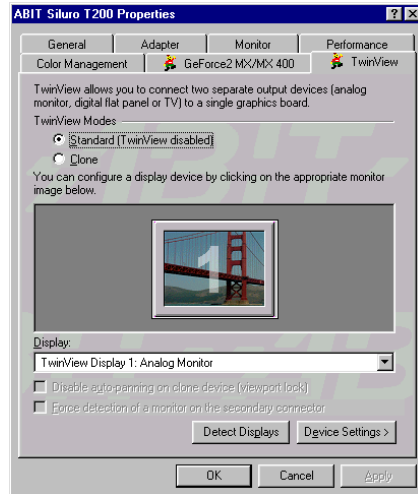

- **TwinView Clone Mode:** This mode outputs an exact copy of the primary display on the secondary device.

To enable Clone Mode, select Clone Mode and click OK or Apply. Both display monitors now display the same image.

To disable Clone Mode, select Standard Mode and click OK or Apply.

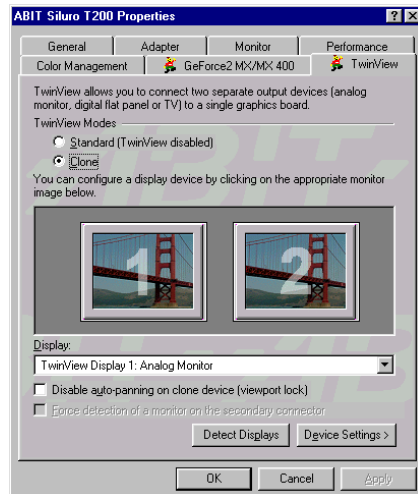

- **Display:** Displays all current TwinView displays. If more than one device is connected and you have switched to a mode other than Standard, you select which display is the current display. You can also click on the monitor graphic in the control directly above to select it as the current display.
- **Disable auto-panning on clone device (viewport lock):** Turning on this feature will lock the current pan position on the currently selected display. This lets you effectively “freeze” the virtual desktop at a certain position. This is useful for presentations or fine detail work in applications.
- **Force detection of a monitor on the secondary connector:** Check this box if you have a monitor connected to the secondary display connector that is not being detected. This is useful for older monitors or monitors connected with BNC connectors.
- **Device Settings:** Click this button to setup or change settings related to the output device used for the current display.

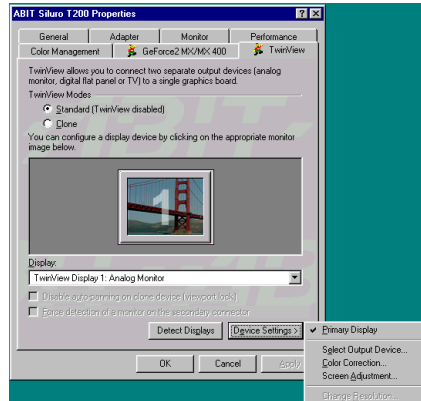

For Windows 2000:

The TwinView functions in Windows 2000 are almost the same as Windows 98/ME except the Extended Desktop Mode is divided into two separate controls: *Horizontal Span* and *Vertical Span*.

- Standard Mode (TwinView disabled):** Use this mode if you have only one display device attached to your graphics adapter.

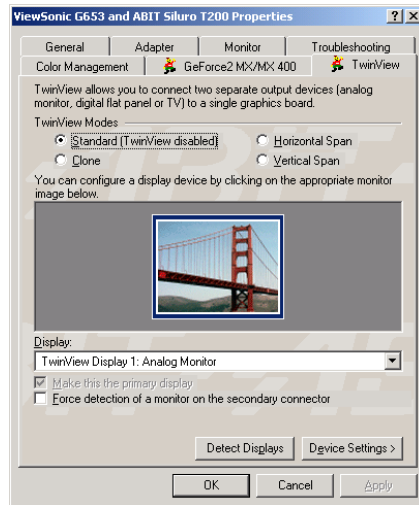

- Clone Mode:** This mode outputs an exact copy of the primary display on the secondary device.

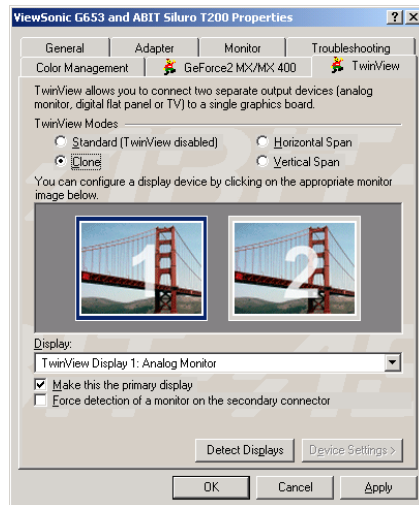

- Horizontal Span:** This mode allows you to extend the Windows desktop across two display devices horizontally. In this mode the two displays combine to form one large spanned display surface, which is useful when viewing items that are wider than a single display.

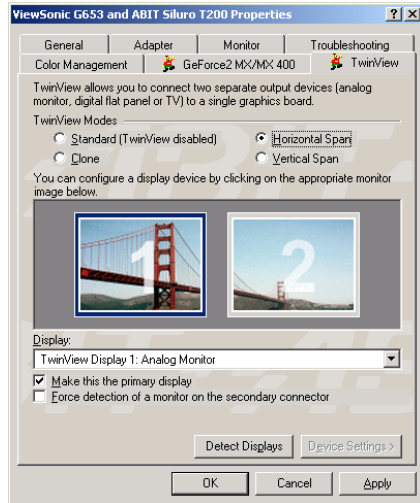

- Vertical Span:** This mode allows you to extend the Windows desktop across two display devices vertically. In this mode the two displays combine to form one large spanned display surface, which is useful when viewing items that are wider than a single display.

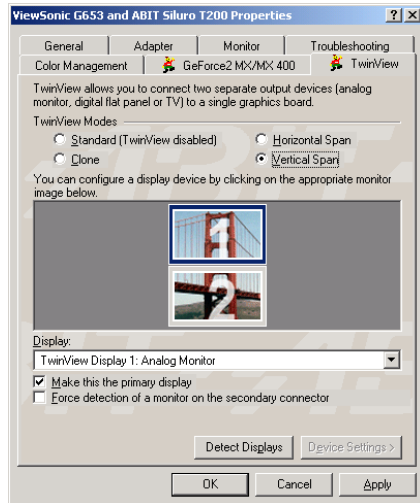

Device Settings

Device Selection:

In the Extended Desktop Mode, the *TwinView* tab in the *Advanced* tab menu is replaced by two tabs: *Device Selection* and *Color Correction*.

This tab allows you to select the output display device (analog monitor, digital flat panel or TV, depending on which devices your display adapter supports).

- **Format:** Indicates the current format and country settings used for TV output.
- **Change Format:** Opens a window where you can specify a particular TV output format.
- **Video output format:** Lets you specify the type of output signal sent to the TV. If you have the proper connector cable, S-Video out will generally provide a higher quality output than Composite video out. If you are not sure which type of signal you should specify, choose the Auto-select setting.
- **Device Adjustment:** Opens a window where you can customize the settings for the active display device.

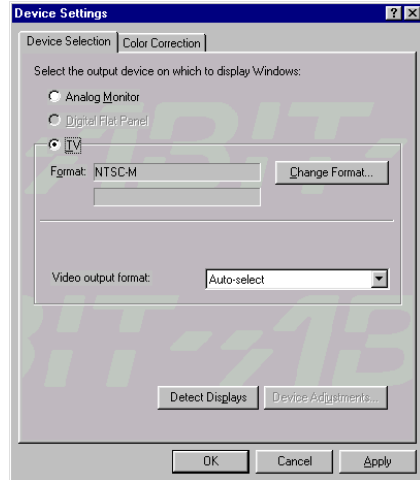

TV Output:

- **Screen Positioning:** Use the arrow buttons to adjust the position of the desktop on the TV.

Note: If the TV picture becomes scrambled or goes blank due to over-adjustment, simply wait 10 seconds. The picture will automatically return to its default position. Then you can begin your adjustments again. Once you have positioned the desktop where you want it, you must press the “OK” or “Apply” button to save the settings before the 10-second interval has elapsed.

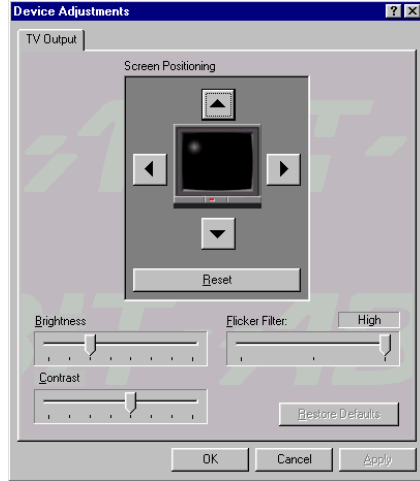

- **Reset:** Resets the desktop to its default position on the TV for the current resolution.
- **Brightness, Contrast:** Use these controls to adjust the brightness and contrast of the TV image.
- **Flicker Filter:** Use this control to adjust the amount of flicker filter you want applied to the TV signal. It is recommended that you turn off the flicker filter completely for DVD movie playback from a hardware decoder.

Color Correction:

- **Digital Vibrance:** Digital Vibrance gives you more control over color separation and intensity, resulting in brighter cleaner images in all of your applications.
- **Active Color Channel:** Allows you to select the color channel controlled by the sliders. You can adjust the red, green or blue channels individually or all three channels at once.
- **Brightness, Contrast, Gamma:** The slider controls allow you to adjust the brightness, contrast or gamma values for the selected color channel. The color correction controls help you to compensate for variations in luminance between a source image and its output on a display device. This is useful when working with image processing applications to help provide more accurate color reproduction of images (such as photographs) when they are displayed on your monitor. Also, many 3D-accelerated games may appear too dark to play. Increasing the brightness and/or gamma value equally across all channels will make these games appear brighter, making them more playable.
- **Custom color settings:** A list of the custom color settings you have saved. Selecting an item from the list will activate the setting.

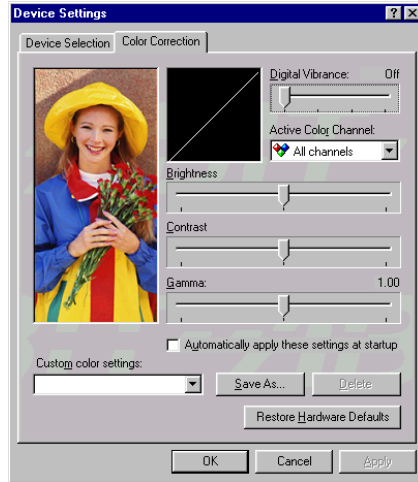

Screen Adjustment:

Use the arrow buttons to adjust the position of the desktop on your monitor.

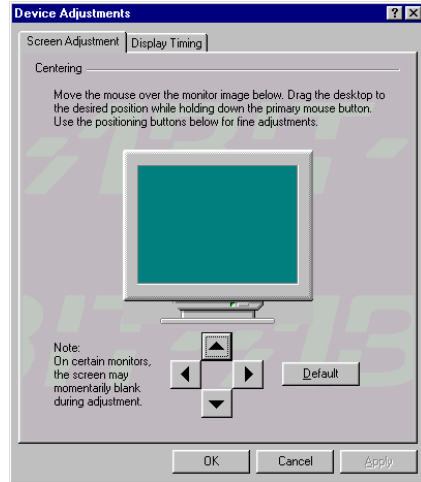

Display Timing:

This tab allows you to select your monitor timing mode:

- **Auto-Detect** allows Windows to receive the proper timing information directly from the monitor itself. This is the default setting. Note that some older monitors may not support this feature.
- **General Timing Formula (GTF)** is a standard used by most newer hardware.
- **Discrete Monitor Timings (DMT)** is an older standard still in use on some hardware. Enable this option if your hardware requires DMT.

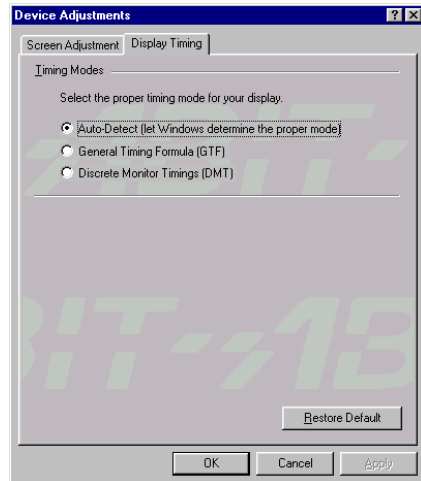

4-2. WinDVD

The WinDVD is a simple-to-use DVD player combining all the features you would expect to find in a standard consumer DVD player, in addition to some very advanced functionality, such as full VCD 2.0 support, full precision video decode, a choice of user interfaces, and video display options. You can play DVD titles or Video CDs - WinDVD automatically determines the type of disc in the DVD drive and uses the correct playback method.

1. Start Windows. Insert the Installation CD into CD-ROM drive, it should execute the installation program automatically. If not, double-click the execution file at the main directory of this Installation CD to enter the installation menu.

Click “WinDVD”.



2. The welcome screen appears. Click “Next>” to start installation.

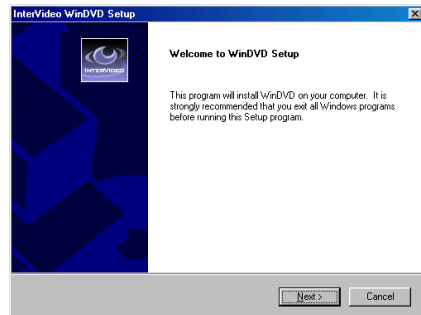

3. Read the license agreement. Click “Yes” to continue.

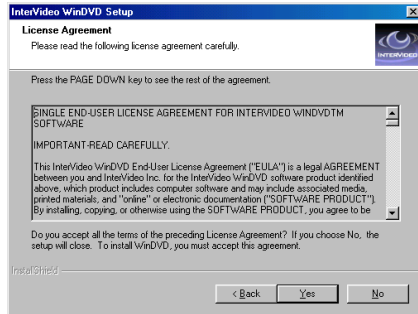

4. Enter your name, the name of the company for whom you work, and the product serial number. Click “Next>” to continue.

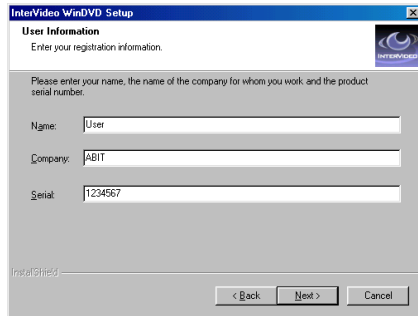

5. Setup will install WinDVD in the following folder. To install to this folder, click “Next>”. To install to a different folder, click “Browse...” and select another folder.

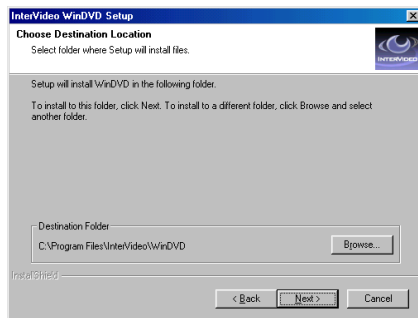

6. Type a new folder name, or select one from the existing folders list. Click “Next>” to continue.

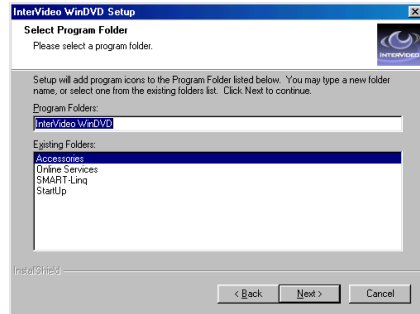

7. Select the application you want to install, and then click “Next>”.

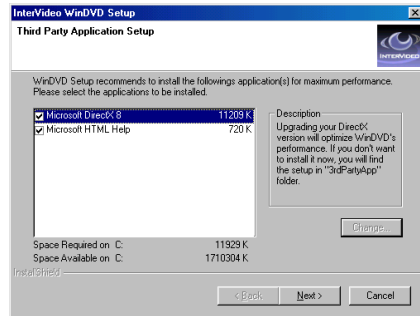

8. When the installation has finished installing all the necessary procedures, it will prompt you to restart your computer. Click “OK” to complete the installation.

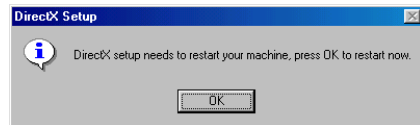

4-3. DirectX

For the best gaming capability, we suggest that you install the latest DirectX driver. Some newer games will also ask you to install the DirectX driver before you start them.

1. Start Windows. Insert the Installation CD into CD-ROM drive, it should execute the installation program automatically. If not, double-click the execution file at the main directory of this Installation CD to enter the installation menu.

Click “DirectX”.

2. Click “Yes” to start installation.

3. Read the following license agreement carefully. Click “Yes” to continue.

4. Click “OK” to complete the installation.

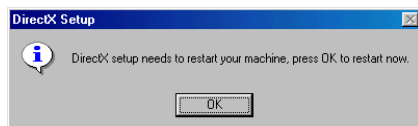
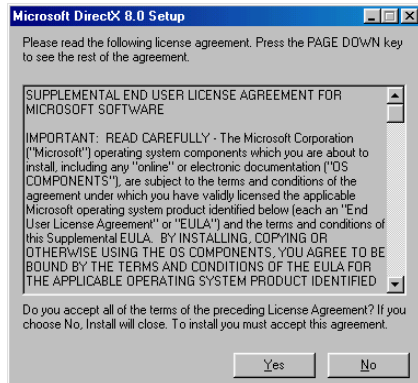
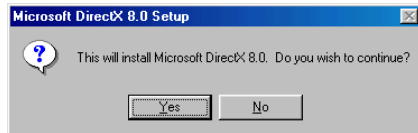

Note: Some games written for older DirectX version may not work properly under DirectX 8.0. Please make sure your application support DirectX 8.0 before installation. Also note that the DirectX 8.0 cannot be uninstalled in normal way.

4-4. Graphic Max

We have provided you with a tool for adjusting both the graphic processors working speed and the graphic memory speed. Please be reminded that it may cause damage to both the graphic processor and graphic memory if you use incorrect settings. Please read the following description carefully before running Graphic Max!

Important Warning Message

ABIT does not provide any warranty or support for this utility. The usage of this utility is at your own risk. This risk includes all damages caused by this utility. If you don't accept this warning, don't use this utility.

ABIT does not recommend any over-clocking settings for your hardware. Over-clocking can cause overheating which will damage your chip.

If you are not acquainted with the display card hardware, we strongly recommend that you not to use this utility. Improper settings can cause unrecoverable damages to your graphics chip, your display card, and other components!

Application Notes

This utility is provided for fine-tuning your display card to allow for maximum stability on your system. It is for Windows® 98/ME only.

Select “Start → Programs → ABIT → Graphic Max” to launch Graphic Max.

If you have adjusted the Graphic Max settings and have problems after booting, you can boot into “Windows Safe Mode” and then run “Start → Programs → ABIT → Graphic Max Safe Mode Recovery” to clear previous settings.

1. Start Windows. Insert the Installation CD into CD-ROM drive, it should execute the installation program automatically. If not, double-click the execution file at the main directory of this Installation CD to enter the installation menu.

Click “VGA Utility”.



2. Click “Graphic Max”.

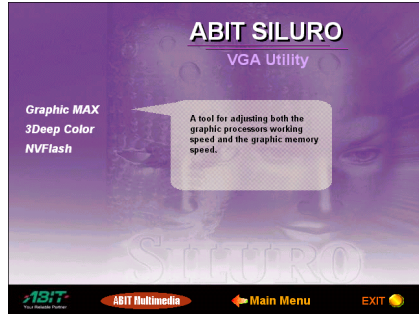

3. The welcome screen appears. Click “Next>” to start installation.

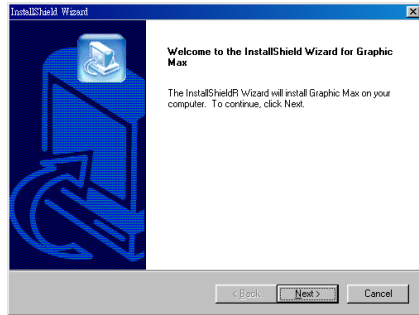

4. Setup will install Graphic Max in the following folder. To install to this folder, click “Next>”. To install to a different folder, click “Browse...” and select another folder.

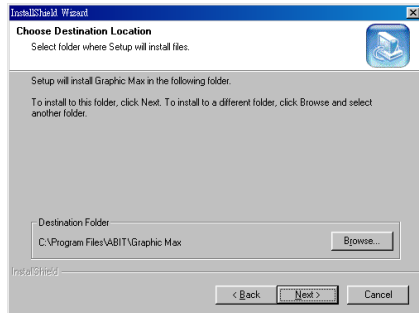

5. Type a new folder name, or select one from the existing folders list. Click “Next>” to continue.

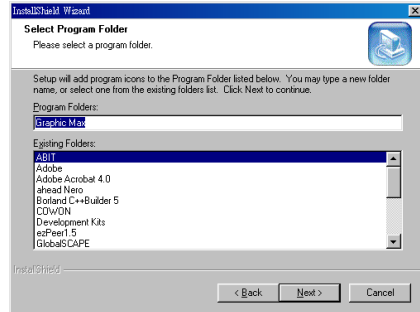

6. Click “Finish” to complete the setup.

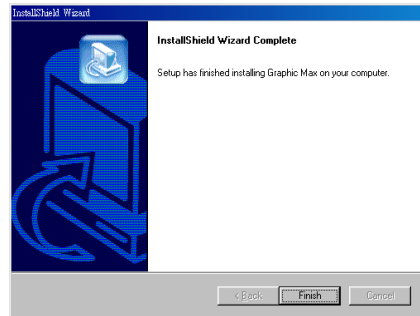

7. Select “Start → Programs → ABIT → Graphic Max” to launch Graphic Max.
8. Each time you execute the program, you will see this warning message screen. Read the entire message and then click “Agree” to continue.

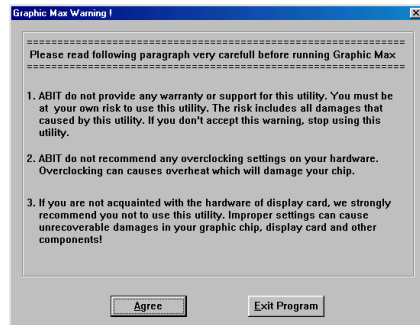

9. When the Graphic Max screen appears, you can use the sliders to adjust the “Core Clock Frequency” and the “Memory Clock Frequency”. Please proceed with care.

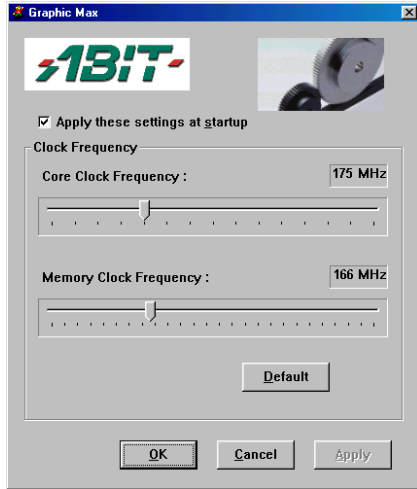

4-5. 3Deep Color

The 3Deep Color is an application to correct lighting, shading and color for all your 2D and 3D games. You get more realistic graphics and better effects, plus a “see first, shoot first” advantage over your online competitors. Finally, you can take your hands off your monitor controls and put them back where they belong -- on the warm trigger of your laser-sighted rocket launcher.

1. Start Windows. Insert the Installation CD into CD-ROM drive, it should execute the installation program automatically. If not, double-click the execution file at the main directory of this Installation CD to enter the installation menu.

Click “VGA Utility”.

2. Click “3Deep Color”.

3. The welcome screen appears. Click “Next>” to start installation.

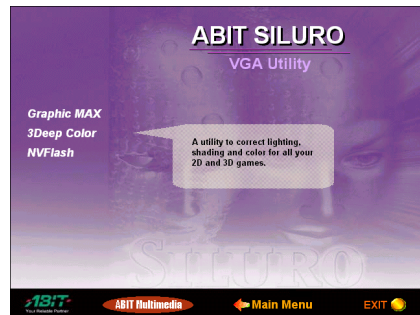

4. Read the license agreement. Click “Yes” to continue.

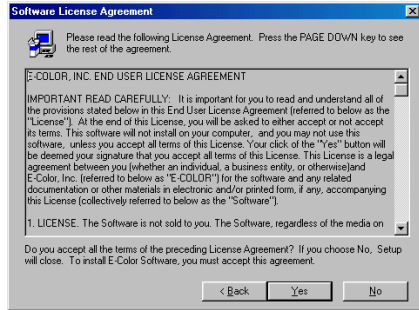

5. Setup will install E-Color Software in the following folder. To install to this folder, click “Next>”. To install to a different folder, click “Browse...” and select another folder.

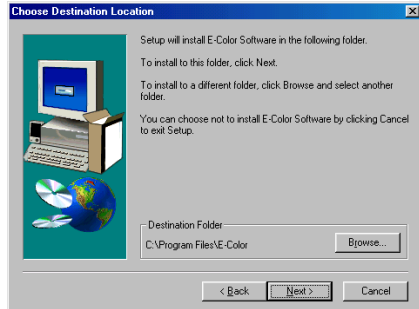

6. Click “Next”.

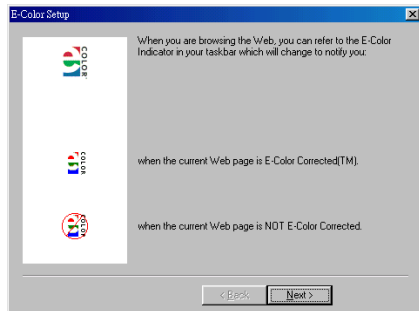

- 7. Select the item you would like to launch and click “Next” to continue.

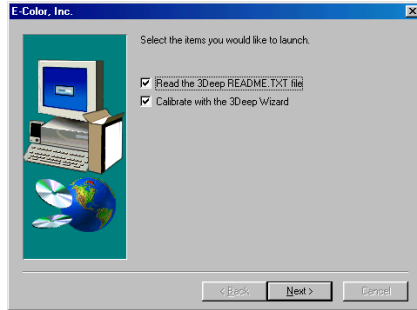

- 8. The 3Deep Color Wizard appears. Click on the icon of your monitor type from CRT and Flat Panel.

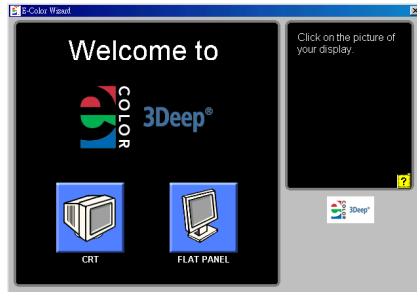

- 9. Set the brightness control of your monitor to maximum, and then reduce the brightness control until the farthest monster image disappears.

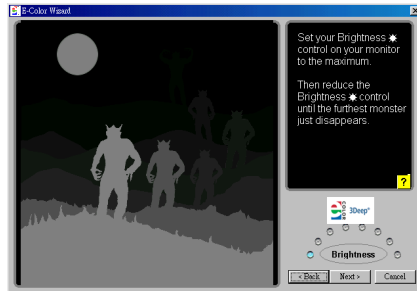

10. Click on the blue, red, and green patches where you see just a hint of color. Do not change the monitor brightness now.

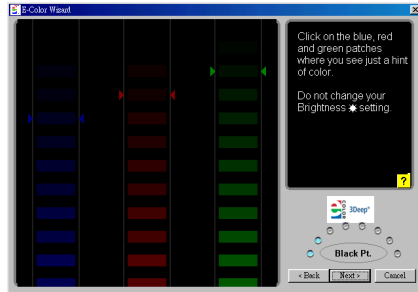

11. Click on the blue, red, and green square that appears to be blend into the background.

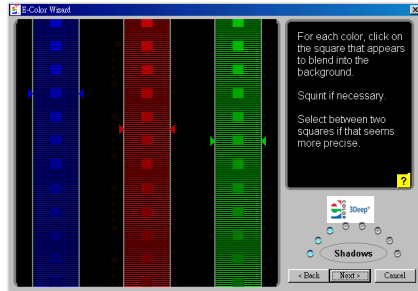

12. Click on the blue, red, and green square that appears to be blend into the background.

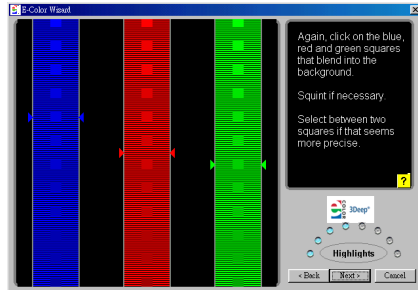

13. Click “Finish” to end the 3Deep Color setup.



14. Click “Complete Now!” to set up True Internet Color.

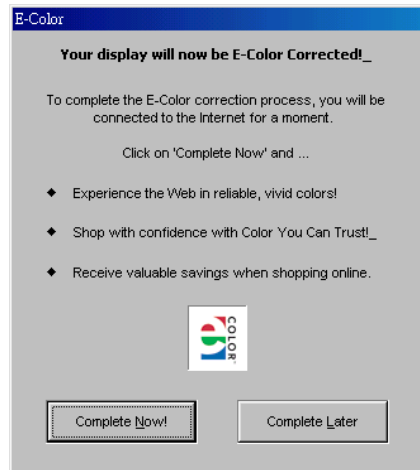

15. This tab explains the meaning of each different icon appears in the taskbar.

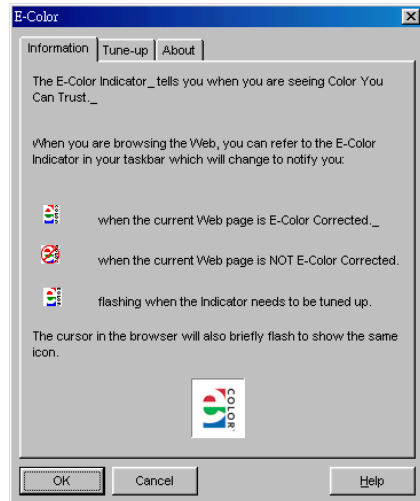

- 16. Tune up the Internet Color in this tab.

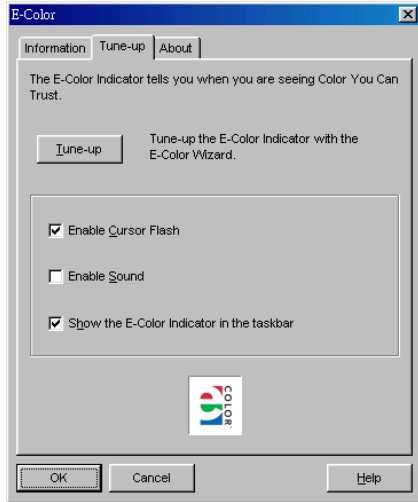

- 17. This tab indicates the WEB site of E-Color, and the version of the True Internet Color.

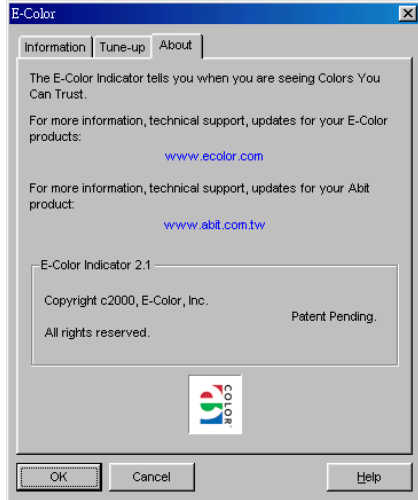

4-6. Display Tray Icon

After installation of display drivers, you will find a display tray icon on the taskbar's status area. Clicking this icon opens this Display Tray, showing a menu composed of shortcuts of the graphics board's enhanced and other functions.

Note: Besides clicking this display tray icon to control the display properties, another way to do this is to right-click the Windows desktop area, click **Properties** → **Settings** → **Advanced**, and then click the appropriate tab to change your display settings.

1. Right-click this display tray icon on the taskbar's status area.



2. A menu pops up. Move the cursor to "More Resolution" item to see the entire resolution table. Here you can directly choose the display resolution you want.

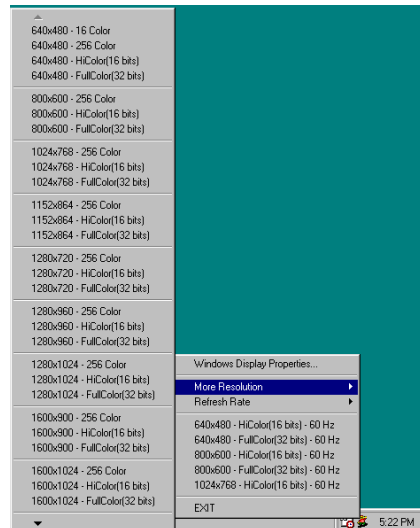

3. If you want to change the refresh rate of display adapter, move cursor to “Refresh Rate”, here you can directly choose the display refresh rate you want.

***Note:** Make sure your display monitor supports the higher refresh rate you choose; otherwise, your monitor may not display normally. Please refer to your display monitor user’s manual for detailed specifications.*

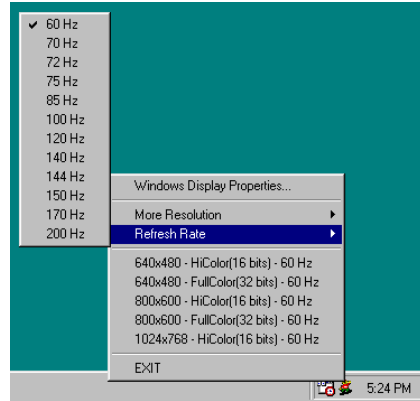

4. Click “Windows Display Properties...” to start setting up your display properties.
5. Choose “Exit” to leave this program.

4-7. BIOS Flashing Utility

You may update the newest SILURO MX200/MX400/T200/T400 drivers or BIOS files from your dealer or directly download from our WEB site at <http://www.abit.com.tw>.

Note: When you use the flash utility to flash the BIOS, the screen will be blank for about 10 seconds. This is a normal situation, not a malfunction. Do not reboot your computer during this period, or you may cause the flash to fail.

1. Reboot your computer into DOS environment, or open a Windows® 95/98 window to the DOS prompt.
2. Insert the Installation CD into your CD-ROM drive.
3. Copy DOS4GW.EXE and NVFLASH.EXE to a new directory from path D:\NVFLASH. (D: refers to the CD-ROM drive letter)
4. Copy the new BIOS binary file to the new directory.
5. Change to the new directory and type the following command:
NVFLASH -F[Filename]. ([Filename] refers to the name of BIOS binary file.)
Then press the "Enter" key. The program will begin flashing your display card BIOS.
6. When the flash is complete (the screen will display images again), you must reboot your computer system to make flash take effect.

The following commands are for the NVIDIA Flash ROM programming utility V3.18, for your reference only.

NVIDIA Flash ROM utility v03.18 Commands List:

Example of use: NVFLASH -s4 -fBIOS.ROM -l

-f<filename>	Flash the ROM using <filename>, then do compare and ~CRC32.
<filename>	Same as -f, but forces confirmation.
-b<filename>	Read ROM and save to <filename>.
-k<filename>	Read ROM and compare with <filename>.
-x<filename>	Xfer TV data from file to AT29LV512; SST29LE/VE512 SST39VF512.
-v<filename>	Display file version and ~CRC32 (if no filename, acts on ROM).
-t	Display 256 bytes of ROM, at offset C000h
-e	Erase the ROM.
-d	Display 256 bytes of ROM, at offset 0.
-c	Check for supported EEPROM.
-l	Don't light keyboard LEDs.
-p	Don't pause if ROMfile & chip PCI VenID, DevID mismatch.
-u	Don't pause if ROMfile & chip PCI subsystem ID mismatch.
-h	Reboot the PC after other tasks completed.
-w	Write protect ROM (only works on some ROMs).
-r	Remove ROM Write protect. (only works on some ROMs).
-a	List all supported device indexes.
-g<deviceid>	Force a specific device index.
-i<instance>	Force specific device instance (use with -g).
-?	Display this screen.
-s#	Silence level:
default	All progress messages, all beeps.
#=1	No progress messages, no beeps.
#=2	No progress messages, no progress beeps.
#=3	No progress messages.
#=4	No progress beeps.
#=5	No beeps.

NVFLASH supports these EEPROMs:

SST	29EE512	64Kx8	5.0V,	128B page,	0k blk,	Man,Dev=(BF,5D)
SST	29LE/VE512	64Kx8	2.9,2.7V,	128B page,	0k blk,	Man,Dev=(BF,3D)
SST	29EE010	128Kx8	5.0V,	128B page,	0k blk,	Man,Dev=(BF,07)
SST	29LE/VE010	128Kx8	2.9,2.7V,	128B page,	0k blk,	Man,Dev=(BF,08)
SST	39VF512	64Kx8	2.7-3.6V,	1B page,	4k blk,	Man,Dev=(BF,D4)
SST	39VF010	128Kx8	2.7-3.6V,	1B page,	4k blk,	Man,Dev=(BF,D5)
SST	39SF010	128Kx8	5.0V,	1B page,	4k blk,	Man,Dev=(BF,B5)
SST	29EE020	256Kx8	5.0V,	128B page,	0k blk,	Man,Dev=(BF,10)
SST	29LE/VE020	256Kx8	2.9,2.7V,	128B page,	0k blk,	Man,Dev=(BF,12)
SST	39VF020	256Kx8	2.7-3.6V,	1B page,	4k blk,	Man,Dev=(BF,D6)
Atmel	29C512	64Kx8	5.0V,	128B page,	0k blk,	Man,Dev=(1F,5D)
Atmel	29C010A	128Kx8	5.0V,	128B page,	0k blk,	Man,Dev=(1F,D5)
Atmel	29LV512	64Kx8	3.0V,	128B page,	0k blk,	Man,Dev=(1F,3D)
Atmel	29LV/BV010A	128Kx8	3.0V,	128B page,	0k blk,	Man,Dev=(1F,35)
Atmel	49F512	64Kx8	5.0,3.0,2.7V,	1B page,	0k blk,	Man,Dev=(1F,03)
Atmel	49F001	128Kx8	5.0V,	1B page,	0k blk,	Man,Dev=(1F,05)
Atmel	49F001T	128Kx8	5.0V,	1B page,	0k blk,	Man,Dev=(1F,04)
Atmel	49F010	128Kx8	5.0V,	1B page,	0k blk,	Man,Dev=(1F,87)
Atmel	49(H)BV/LV01	128Kx8	2.7-3.6V,	1B page,	0k blk,	Man,Dev=(1F,17)
Atmel	49LV_BV002	256Kx8	3.0,2.7V,	1B page,	0k blk,	Man,Dev=(1F,07)
Atmel	49LV_BV002T	256Kx8	3.0,2.7V,	1B page,	0k blk,	Man,Dev=(1F,07)
Atmel	49F_LV_BV020	256Kx8	5.0,3.0,2.7V,	1B page,	0k blk,	Man,Dev=(1F,0B)
Atmel	29F_LV_BV020	256Kx8	5.0,3.0,2.7V,	1B page,	0k blk,	Man,Dev=(1F,BA)
AMD	29LV010	128Kx8	2.7vV,	1B page,	16k blk,	Man,Dev=(01,6E)
AMD	29LV001T	128Kx8	2.7vV,	1B page,	16k blk,	Man,Dev=(01,ED)
AMD	29LV001B	128Kx8	2.7vV,	1B page,	16k blk,	Man,Dev=(01,6D)
MX	29F001T	128Kx8	5.0V,	1B page,	0k blk,	Man,Dev=(C2,18)
MX	29F001B	128Kx8	5.0V,	1B page,	0k blk,	Man,Dev=(C2,19)
ST	M29W512B	64Kx8	2.7-3.6V,	1B page,	0k blk,	Man,Dev=(20,27)
Wbond	W29EE512	64Kx8	5.0V,	128B page,	0k blk,	Man,Dev=(DA,C8)
PMC	39LV512R	64Kx8	3.0-3.6V,	1B page,	0k blk,	Man,Dev=(9D,1B)
PMC	39LV010R	128Kx8	3.0-3.6V,	1B page,	0k blk,	Man,Dev=(9D,1C)
PMC	29F002	256Kx8	3.0-3.6V,	1B page,	4k blk,	Man,Dev=(9D,1D)

Appendix A. How to Get Technical Support

(From our website) <http://www.abit.com.tw>
(In North America) <http://www.abit-usa.com>
(In Europe) <http://www.abit.nl>

Thank you for choosing ABIT products. ABIT sells all our products through distributors, resellers and system integrators; we have no direct sales to end-users. Before sending email for tech support please check with your resellers or integrators if you need any services, they are the ones who sold you your system and they should know best as to what can be done, how they serve you is a good reference for future purchases.

We appreciate every customer and would like to provide the best service to you. Providing fast service to our customers is our top priority. However we receive many phone calls and a huge amount of email from all over the world. At the present time it is impossible for us to respond to every single inquiry. Therefore it is quite possible that if you send an email to us that you may not receive a response.

We have done many compatibility tests and reliability tests to make sure our products have the best quality and compatibility. In case you need service or technical support, please understand the constraint we have and **always check with the reseller who sold the product to you first.**

To expedite service, we recommend that you follow the procedures outlined below before contacting us. With your help, we can meet our commitment to provide the best service to the **greatest number of ABIT customers:**

- 1. Check the Manual.** It sounds simple but we have taken a lot of care in making a well-written and thorough manual. It is full of information that doesn't only pertain to motherboards. The CD-ROM included with your board will have the manual as well as drivers. If you don't have either one, go to our Program Download Area of the Website or FTP server.
- 2. Download latest BIOS, software or drivers.** Please go to our Program Download area on our Website to check to see if you have the latest BIOS. They are developed over periods of time to fix bugs or incompatibilities. **Also please make sure you have the latest drivers from your peripheral cards makers!**
- 3. Check the ABIT Technical Terms Guide and FAQ on our Website.** We are trying to expand and make the FAQs more helpful and information rich. Let us know if you have any suggestions. For hot topics check out our HOT FAQ!

4. **Internet Newsgroups.** They are a great source of information and many people there can offer help. ABIT's Internet News group, **[alt.comp.periphs.mainboard.abit](#)**, is an ideal forum for the public to exchange information and discuss experiences they have had with ABIT products. Many times you will see that your question has already been asked before. This is a public Internet news group and it is reserved for free discussions. Here is a list of some of the more popular ones:

[alt.comp.periphs.mainboard.abit](#)

[comp.sys.ibm.pc.hardware.chips](#)

[alt.comp.hardware.overclocking](#)

[alt.comp.hardware.homebuilt](#)

[alt.comp.hardware.pc-homebuilt](#)

5. **Ask your reseller.** Your ABIT authorized distributor should be able to provide the fastest solution to your technical problem. We sell our products through distributors who sell to resellers and stores. Your reseller should be very familiar with your system configuration and should be able to solve your problem much more efficiently than we could. After all, your reseller regards you as an important customer who may purchase more products and who can urge your friends to buy from him or her as well. They integrated and sold the system to you. They should know best what your system configuration is and your problem. They should have reasonable return or refund policies. How they serve you is also a good reference for your next purchase.
6. **Contacting ABIT.** If you feel that you need to contact ABIT directly you can send email to the ABIT technical support department. First, please contact the support team for the branch office closest to you. They will be more familiar with local conditions and problems and will have better insight as to which resellers offer what products and services. Due to the huge number of emails coming in every day and other reasons, such as the time required for problem reproduction, we will not be able to reply to every email. Please understand that we are selling through distribution channels and don't have the resources to serve every end-user. However, we will try to do our best to help every customer. Please also remember that for many of our technical support team English is a second language, you will have a better chance of getting a helpful answer if your question can be understood in the first place. Be sure to use very, simple, concise language that clearly states the problem, avoid rambling or flowery language and always list your system components. Here is the contact information for our branch offices:

In North America and South America please contact:

ABIT Computer (USA) Corporation

46808 Lakeview Blvd.

Fremont, California 94538, U.S.A.

sales@abit-usa.com

technical@abit-usa.com

Tel: 1-510-623-0500

Fax: 1-510-623-1092

In the UK and Ireland:

ABIT Computer Corporation Ltd.

Unit 3, 24-26 Boulton Road

Stevenage, Herts SG1 4QX, UK

abituksales@compuserve.com

abituktech@compuserve.com

Tel: 44-1438-228888

Fax: 44-1438-226333

In Germany and Benelux (Belgium, Netherlands, Luxembourg) countries:

AMOR Computer B.V. (ABIT's European Office)

Van Coehoornstraat 7,

5916 PH Venlo, The Netherlands

sales@abit.nl

technical@abit.nl

Tel: 31-77-3204428

Fax: 31-77-3204420

All other territories not covered above please contact:

Taiwan Head Office

When contacting our headquarters please note we are located in Taiwan and we are 8+ GMT time. In addition, we have holidays that may be different from those in your country.

ABIT Computer Corporation

3F-7, No. 79, Sec. 1, Hsin Tai Wu Rd.

Hsi Chi, Taipei Hsien, Taiwan

sales@abit.com.tw

market@abit.com.tw

technical@abit.com.tw

Tel: 886-2-2698-1888

Fax: 886-2-2698-1811

7. **RMA Service.** If your system has been working but it just stopped, but you have not installed any new software or hardware recently, it is likely that you have a defective component. Please contact the reseller from whom you bought the product. You should be able to get RMA service there.
8. **Reporting Compatibility Problems to ABIT.** Because of tremendous number of email messages we receive every day, we are forced to give greater weight to certain types of messages than to others. For this reason, any compatibility problem that is reported to us, giving detailed system configuration information and error symptoms will receive the highest priority. For the other questions, we regret that we may not be able to reply directly. But your questions may be posted to the Internet news group in order that a larger number of users can have the benefit of the information. Please check the news group from time to time.
9. **How to Get Technical Support:** If you encounter any problems and need help from our technical staff, please take the time to fill out the Technical Support Form and send it to your dealer or our technical support mailbox. The mailbox address is: technical@abit.com.tw. We will try to solve your problem as soon as possible. You must provide specific information on your equipment. Also please describe in detail the problems you encountered. It's helpful and enables our technicians to analyze your problems more quickly.

Information on items marked with an asterisk "*" on the Technical Support Form are required.

 **Technical Support Form**

 **Company Name:**

 **Phone Number:**

 **Contact Person:**

 **Fax Number:**

 **E-mail Address:**

VGA Card Product Name	*	VGA Card BIOS Version	*
Motherboard Manufacturer, Model Name and Chipset type	*	VGA Card Software and Driver Version	*
Operating System Type	*	Monitor Manufacturer and Model	*
Hardware name			
	Type	Specifications	
CPU Type and Speed	*		
HDD			
IDE1			
IDE2			
CD-ROM Drive			
IDE1			
IDE2			
System Memory Size (SDRAM)	*		
Add-On Card	*		

Problem Description:



Thank you, ABIT Computer Corporation

<http://www.abit.com.tw>